

DATA SHEET

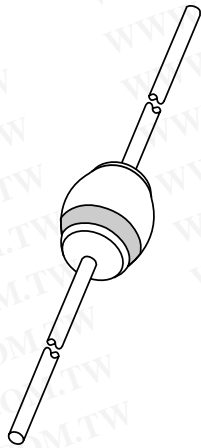

BZT03 series Voltage regulator diodes

Product specification
Supersedes data of April 1992

1996 Jun 11

Voltage regulator diodes

BZT03 series

FEATURES

- Glass passivated
- High maximum operating temperature
- Low leakage current
- Excellent stability
- Zener working voltage range: 7.5 to 270 V for 38 types
- Transient suppressor stand-off voltage range: 6.2 to 430 V for 45 types
- Available in ammo-pack.

DESCRIPTION

Rugged glass SOD57 package, using a high temperature alloyed

construction. This package is hermetically sealed and fatigue free as coefficients of expansion of all used parts are matched.

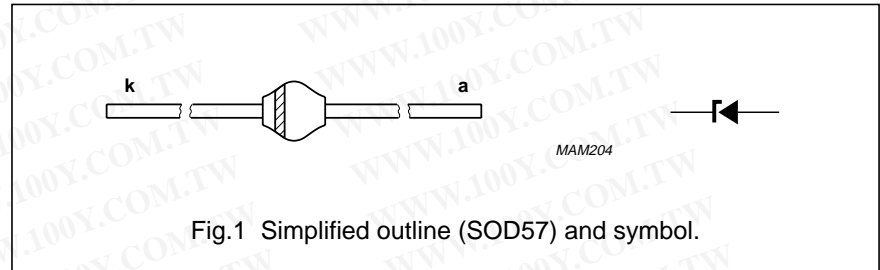

LIMITING VALUES

In accordance with the Absolute Maximum Rating System (IEC 134).

SYMBOL	PARAMETER	CONDITIONS	MIN.	MAX.	UNIT
P _{tot}	total power dissipation	T _{tp} = 25 °C; lead length 10 mm; see Fig.2	–	3.25	W
		T _{amb} = 45 °C; see Fig.2; PCB mounted (see Fig.6)	–	1.30	W
P _{ZRM}	repetitive peak reverse power dissipation		–	10	W
P _{ZSM}	non-repetitive peak reverse power dissipation	t _p = 100 μs; square pulse; T _j = 25 °C prior to surge; see Fig.3	–	600	W
P _{RSM}	non-repetitive peak reverse power dissipation	10/1 000 μs exponential pulse (see Fig.4); T _j = 25 °C prior to surge	–	300	W
T _{stg}	storage temperature		–65	+175	°C
T _j	junction temperature		–65	+175	°C

勝特力材料 886-3-5753170
 勝特力电子(上海) 86-21-54151736
 勝特力电子(深圳) 86-755-83298787
[Http://www.100y.com.tw](http://www.100y.com.tw)

Voltage regulator diodes

勝特力材料 886-3-5753170
 勝特力电子(上海) 86-21-54151736
 勝特力电子(深圳) 86-755-83298787
[Http://www.100y.com.tw](http://www.100y.com.tw)

BZT03 series

ELECTRICAL CHARACTERISTICS

Total series

$T_j = 25\text{ }^\circ\text{C}$ unless otherwise specified.

SYMBOL	PARAMETER	CONDITIONS	MAX.	UNIT
V_F	forward voltage	$I_F = 0.5\text{ A}$; see Fig.5	1.2	V

Per type when used as voltage regulator diodes

$T_j = 25\text{ }^\circ\text{C}$ unless otherwise specified.

TYPE No. SUFFIX (1)	WORKING VOLTAGE			DIFFERENTIAL RESISTANCE		TEMPERATURE COEFFICIENT		TEST CURRENT	REVERSE CURRENT at REVERSE VOLTAGE	
	V_Z (V) at I_Z			r_{dif} (Ω) at I_Z		S_Z (%/K) at I_Z		I_Z (mA)	I_R (μA)	V_R (V)
	MIN.	NOM.	MAX.	TYP.	MAX.	MIN.	MAX.		MAX.	
C7V5	7.0	7.5	7.9	1	2	0.00	0.07	100	750	5.6
C8V2	7.7	8.2	8.7	1	2	0.03	0.08	100	600	6.2
C9V1	8.5	9.1	9.6	2	4	0.03	0.08	50	20	6.8
C10	9.4	10	10.6	2	4	0.05	0.09	50	10	7.5
C11	10.4	11	11.6	4	7	0.05	0.10	50	4	8.2
C12	11.4	12	12.7	4	7	0.05	0.10	50	3	9.1
C13	12.4	13	14.1	5	10	0.05	0.10	50	2	10
C15	13.8	15	15.6	5	10	0.05	0.10	50	1	11
C16	15.3	16	17.1	6	15	0.06	0.11	25	1	12
C18	16.8	18	19.1	6	15	0.06	0.11	25	1	13
C20	18.8	20	21.2	6	15	0.06	0.11	25	1	15
C22	20.8	22	23.3	6	15	0.06	0.11	25	1	16
C24	22.8	24	25.6	7	15	0.06	0.11	25	1	18
C27	25.1	27	28.9	7	15	0.06	0.11	25	1	20
C30	28	30	32	8	15	0.06	0.11	25	1	22
C33	31	33	35	8	15	0.06	0.11	25	1	24
C36	34	36	38	21	40	0.06	0.11	10	1	27
C39	37	39	41	21	40	0.06	0.11	10	1	30
C43	40	43	46	24	45	0.07	0.12	10	1	33
C47	44	47	50	24	45	0.07	0.12	10	1	36
C51	48	51	54	25	60	0.07	0.12	10	1	39
C56	52	56	60	25	60	0.07	0.12	10	1	43
C62	58	62	66	25	80	0.08	0.13	10	1	47
C68	64	68	72	25	80	0.08	0.13	10	1	51
C75	70	75	79	30	100	0.08	0.13	10	1	56
C82	77	82	87	30	100	0.08	0.13	10	1	62
C91	85	91	96	60	200	0.09	0.13	5	1	68

Voltage regulator diodes

BZT03 series

TYPE No. SUFFIX (1)	WORKING VOLTAGE			DIFFERENTIAL RESISTANCE		TEMPERATURE COEFFICIENT		TEST CURRENT	REVERSE CURRENT at REVERSE VOLTAGE	
	V _Z (V) at I _Z			r _{diff} (Ω) at I _Z		S _Z (%/K) at I _Z		I _Z (mA)	I _R (μA)	V _R (V)
	MIN.	NOM.	MAX.	TYP.	MAX.	MIN.	MAX.		MAX.	
C100	94	100	106	60	200	0.09	0.13	5	1	75
C110	104	110	116	80	250	0.09	0.13	5	1	82
C120	114	120	127	80	250	0.09	0.13	5	1	91
C130	124	130	141	110	300	0.09	0.13	5	1	100
C150	138	150	156	130	300	0.09	0.13	5	1	110
C160	153	160	171	150	350	0.09	0.13	5	1	120
C180	168	180	191	180	400	0.09	0.13	5	1	130
C200	188	200	212	200	500	0.09	0.13	5	1	150
C220	208	220	233	350	750	0.09	0.13	2	1	160
C240	228	240	256	400	850	0.09	0.13	2	1	180
C270	251	270	289	450	1000	0.09	0.13	2	1	200

Note

- To complete the type number the suffix is added to the basic type number, e.g. BZT03-C100.

勝特力材料 886-3-5753170
 勝特力电子(上海) 86-21-54151736
 勝特力电子(深圳) 86-755-83298787
[Http://www.100y.com.tw](http://www.100y.com.tw)

Voltage regulator diodes

BZT03 series

Per type when used as transient suppressor diodes

T_j = 25 °C unless otherwise specified.

TYPE NUMBER	REVERSE BREAKDOWN VOLTAGE	TEMPERATURE COEFFICIENT		TEST CURRENT I _{test} (mA)	CLAMPING VOLTAGE		REVERSE CURRENT at STAND-OFF VOLTAGE	
	V _{(BR)R} (V) at I _{test}	S _Z (%/K) at I _{test}			V _{(CL)R} (V) MAX.	at I _{RSM} (A) note 1	I _R (μA) MAX.	at V _R (V)
	MIN.	MIN.	MAX.					
BZT03-C7V5	7.0	0.00	0.07	100	11.3	26.5	1500	6.2
BZT03-C8V2	7.7	0.03	0.08	100	12.3	24.4	1200	6.8
BZT03-C9V1	8.5	0.03	0.08	50	13.3	22.7	100	7.5
BZT03-C10	9.4	0.05	0.09	50	14.8	20.3	20	8.2
BZT03-C11	10.4	0.05	0.10	50	15.7	19.1	5	9.1
BZT03-C12	11.4	0.05	0.10	50	17.0	17.7	5	10
BZT03-C13	12.4	0.05	0.10	50	18.9	15.9	5	11
BZT03-C15	13.8	0.05	0.10	50	20.9	14.4	5	12
BZT03-C16	15.3	0.06	0.11	25	22.9	13.1	5	13
BZT03-C18	16.8	0.06	0.11	25	25.6	11.7	5	15
BZT03-C20	18.8	0.06	0.11	25	28.4	10.6	5	16
BZT03-C22	20.8	0.06	0.11	25	31.0	9.7	5	18
BZT03-C24	22.8	0.06	0.11	25	33.8	8.9	5	20
BZT03-C27	25.1	0.06	0.11	25	38.1	7.9	5	22
BZT03-C30	28	0.06	0.11	25	42.2	7.1	5	24
BZT03-C33	31	0.06	0.11	25	46.2	6.5	5	27
BZT03-C36	34	0.06	0.11	10	50.1	6.0	5	30
BZT03-C39	37	0.06	0.11	10	54.1	5.5	5	33
BZT03-C43	40	0.07	0.12	10	60.7	4.9	5	36
BZT03-C47	44	0.07	0.12	10	65.5	4.6	5	39
BZT03-C51	48	0.07	0.12	10	70.8	4.2	5	43
BZT03-C56	52	0.07	0.12	10	78.6	3.8	5	47
BZT03-C62	58	0.08	0.13	10	86.5	3.5	5	51
BZT03-C68	64	0.08	0.13	10	94.4	3.2	5	56
BZT03-C75	70	0.08	0.13	10	103.5	2.9	5	62
BZT03-C82	77	0.08	0.13	10	114.0	2.6	5	68
BZT03-C91	85	0.09	0.13	5	126	2.4	5	75
BZT03-C100	94	0.09	0.13	5	139	2.2	5	82
BZT03-C110	104	0.09	0.13	5	152	2.0	5	91
BZT03-C120	114	0.09	0.13	5	167	1.8	5	100
BZT03-C130	124	0.09	0.13	5	185	1.6	5	110
BZT03-C150	138	0.09	0.13	5	204	1.5	5	120
BZT03-C160	153	0.09	0.13	5	224	1.3	5	130

Voltage regulator diodes

BZT03 series

TYPE NUMBER	REVERSE BREAKDOWN VOLTAGE	TEMPERATURE COEFFICIENT		TEST CURRENT	CLAMPING VOLTAGE		REVERSE CURRENT at STAND-OFF VOLTAGE	
	$V_{(BR)R}$ (V) at I_{test}	S_z (%/K) at I_{test}		I_{test} (mA)	$V_{(CL)R}$ (V)	at I_{RSM} (A) note 1	I_R (μ A)	at V_R (V)
	MIN.	MIN.	MAX.		MAX.		MAX.	
BZT03-C180	168	0.09	0.13	5	249	1.2	5	150
BZT03-C200	188	0.09	0.13	5	276	1.1	5	160
BZT03-C220	208	0.09	0.13	2	305	1.0	5	180
BZT03-C240	228	0.09	0.13	2	336	0.9	5	200
BZT03-C270	251	0.09	0.13	2	380	0.8	5	220
BZT03-C300	280	0.09	0.13	2	419	0.72	5	240
BZT03-C330	310	0.09	0.13	2	459	0.65	5	270
BZT03-C360	340	0.09	0.13	2	498	0.60	5	300
BZT03-C390	370	0.09	0.13	2	537	0.56	5	330
BZT03-C430	400	0.09	0.13	2	603	0.50	5	360
BZT03-C470	440	0.09	0.13	2	655	0.45	5	390
BZT03-C510	480	0.09	0.13	2	707	0.42	5	430

Note

1. Non-repetitive peak reverse current in accordance with "IEC 60-1, Section 8" (10/1 000 μ s pulse); see Fig.4.

THERMAL CHARACTERISTICS

SYMBOL	PARAMETER	CONDITIONS	VALUE	UNIT
$R_{th j-tp}$	thermal resistance from junction to tie-point	lead length = 10 mm	46	K/W
$R_{th j-a}$	thermal resistance from junction to ambient	note 1	100	K/W

Note

1. Device mounted on an epoxy-glass printed-circuit board, 1.5 mm thick; thickness of Cu-layer $\geq 40 \mu$ m, see Fig.6. For more information please refer to the "General Part of associated Handbook".

勝特力材料 886-3-5753170
 勝特力电子(上海) 86-21-54151736
 勝特力电子(深圳) 86-755-83298787
[Http://www.100y.com.tw](http://www.100y.com.tw)

Voltage regulator diodes

BZT03 series

GRAPHICAL DATA

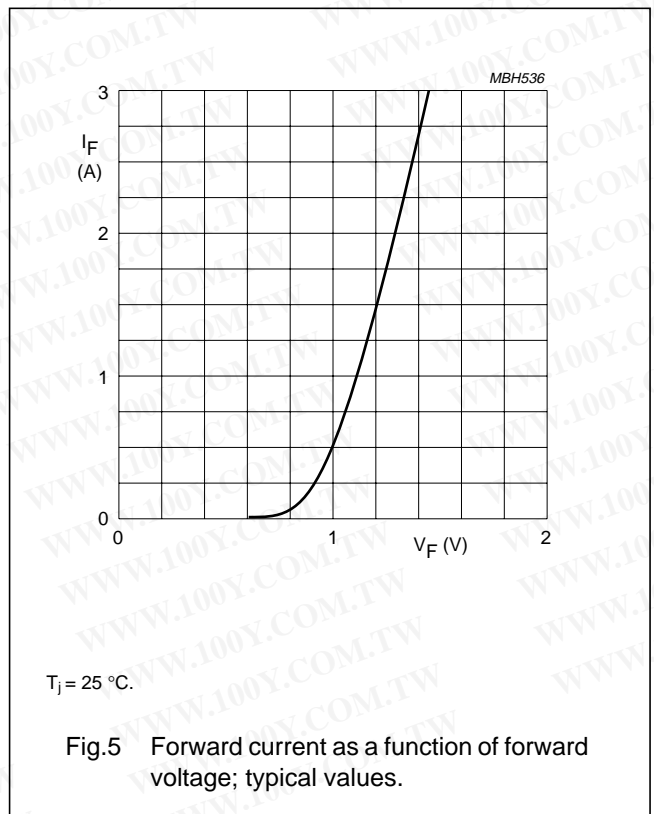
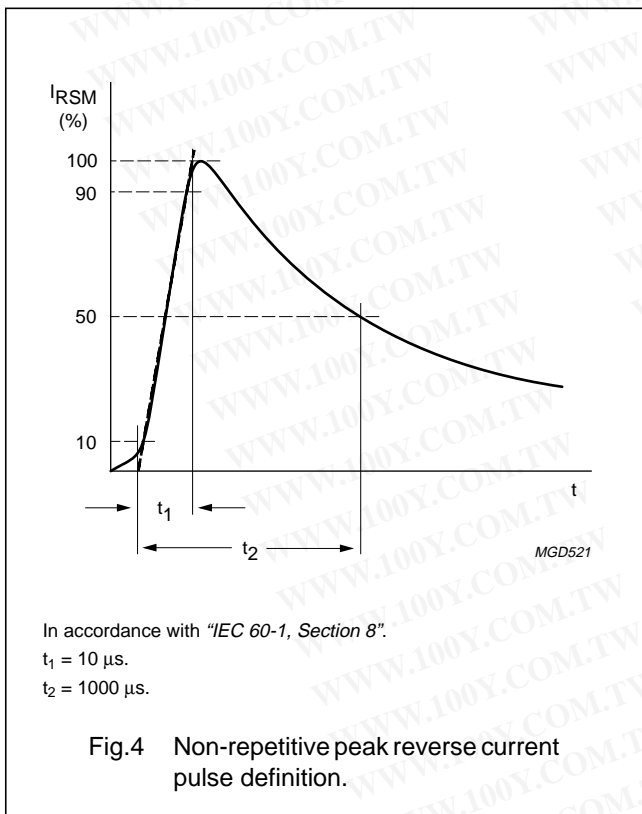
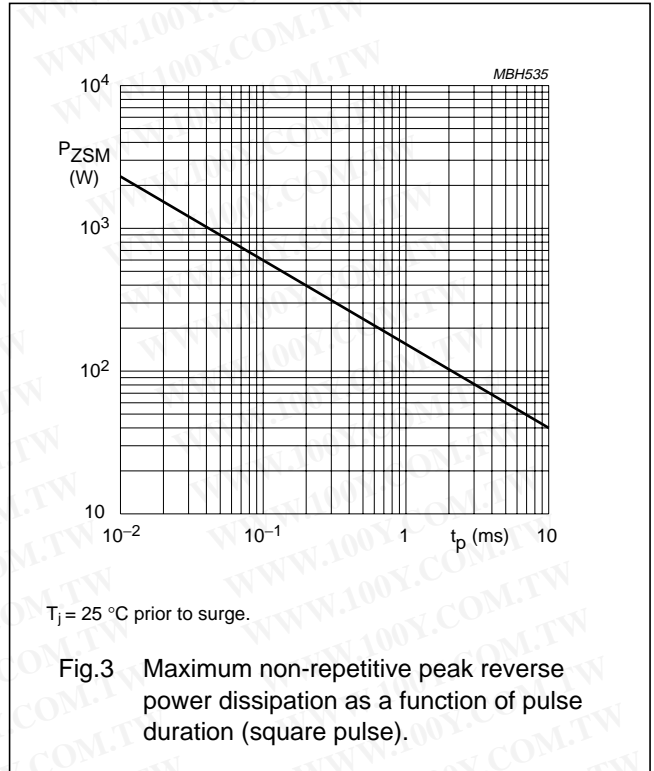
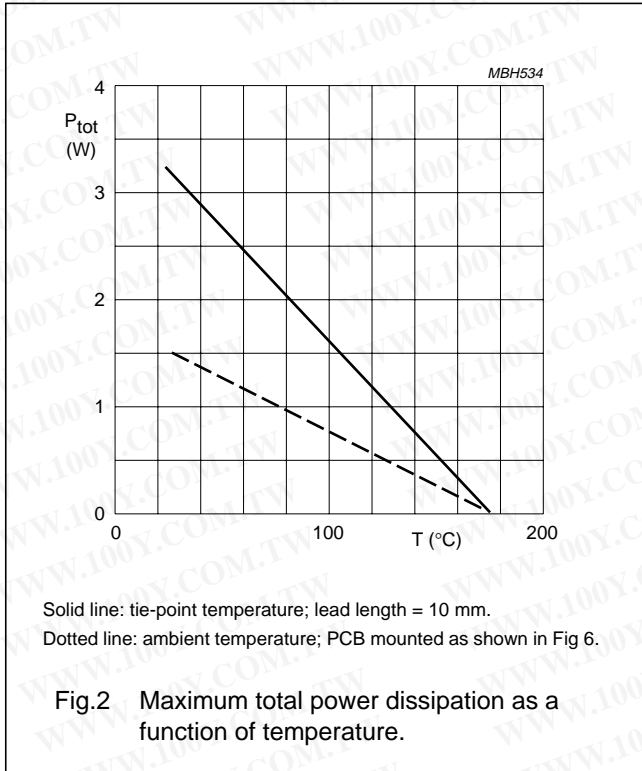

Voltage regulator diodes

BZT03 series

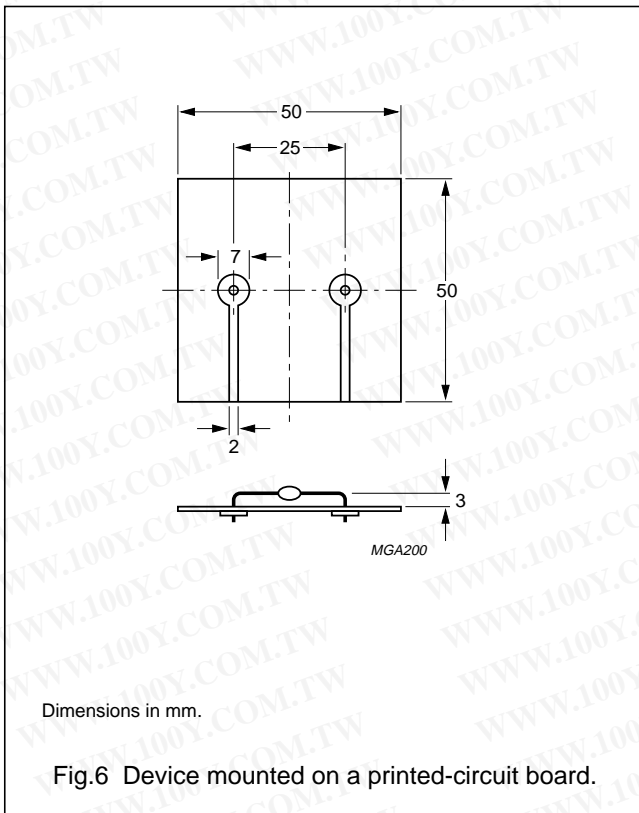

勝特力材料 886-3-5753170
勝特力电子(上海) 86-21-54151736
勝特力电子(深圳) 86-755-83298787
[Http://www.100y.com.tw](http://www.100y.com.tw)

Voltage regulator diodes

BZT03 series

PACKAGE OUTLINE

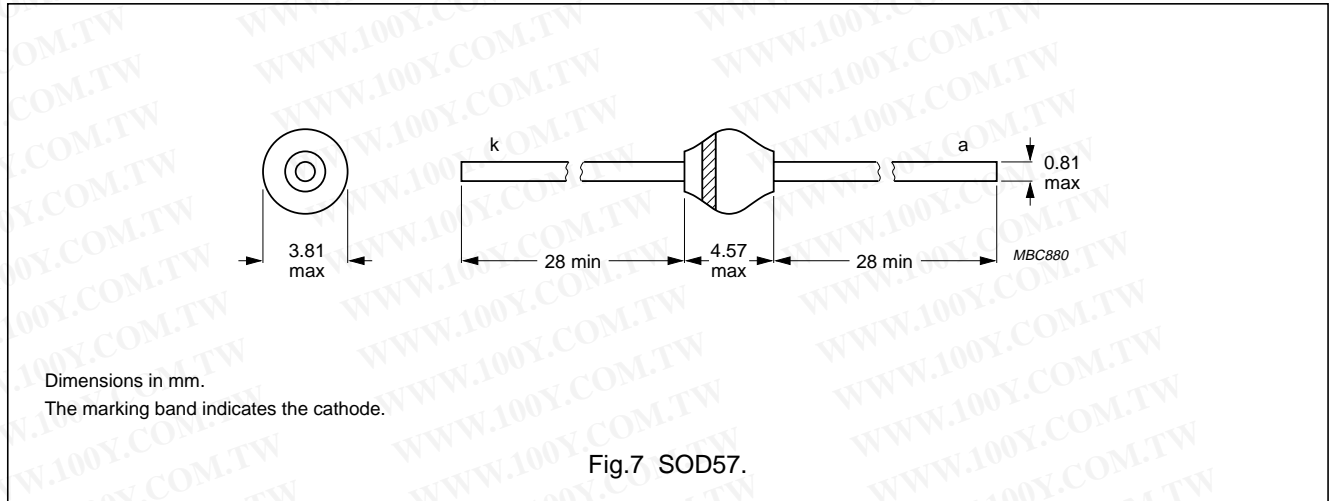

DEFINITIONS

Data sheet status	
Objective specification	This data sheet contains target or goal specifications for product development.
Preliminary specification	This data sheet contains preliminary data; supplementary data may be published later.
Product specification	This data sheet contains final product specifications.
Limiting values	
Limiting values given are in accordance with the Absolute Maximum Rating System (IEC 134). Stress above one or more of the limiting values may cause permanent damage to the device. These are stress ratings only and operation of the device at these or at any other conditions above those given in the Characteristics sections of the specification is not implied. Exposure to limiting values for extended periods may affect device reliability.	
Application information	
Where application information is given, it is advisory and does not form part of the specification.	

LIFE SUPPORT APPLICATIONS

These products are not designed for use in life support appliances, devices, or systems where malfunction of these products can reasonably be expected to result in personal injury. Philips customers using or selling these products for use in such applications do so at their own risk and agree to fully indemnify Philips for any damages resulting from such improper use or sale.

勝特力材料 886-3-5753170
 勝特力电子(上海) 86-21-54151736
 勝特力电子(深圳) 86-755-83298787
[Http://www.100y.com.tw](http://www.100y.com.tw)