

SKKD 42F, SKMD 42F, SKND 42F

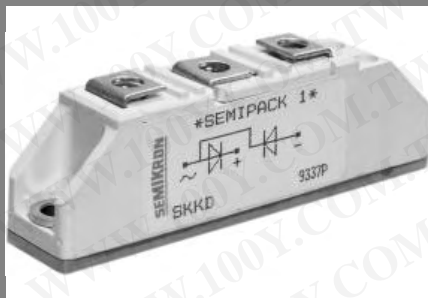

SEMIPACK® 1

Fast Diode Modules

SKKD 42F

SKMD 42F

SKND 42F

Features

- Heat transfer through ceramic isolated metal baseplate
- Hard soldered joints for high reliability
- SKKD half bridge connection; SKMD common cathode; SKND common anode
- UL recognized, file no. E 63 532

Typical Applications

- Self-commutated inverters
- DC choppers
- AC motor speed control
- Inductive heating
- Uninterruptible power supplies
- Electronic welders
- General power switching applications

V_{RSM} V	V_{RRM} V	$I_{FRMS} = 120$ A (maximum value for continuous operation) $I_{FAV} = 42$ A (sin. 180; 50 Hz; $T_c = 85$ °C)		
1000	1000	SKKD 42F10	SKMD 42F10	
1200	1200	SKKD 42F12	SKMD 42F12	SKND 42F12
1400	1400	SKKD 42F14	SKMD 42F14	SKND 42F14
1500	1500	SKKD 42F15	SKMD 42F15	SKKD 42F15

Symbol	Conditions	Values	Units
I_{FAV}	sin. 180; $T_c = 85$ (100) °C	42 (31)	A
I_{FSM}	$T_{vj} = 25$ °C; 10 ms	1200	A
	$T_{vj} = 130$ °C; 10 ms	1100	A
i^2t	$T_{vj} = 25$ °C; 8,3 ... 10 ms	7200	A ² s
	$T_{vj} = 130$ °C; 8,3 ... 10 ms	6000	A ² s
V_F	$T_{vj} = 25$ °C; $I_F = 150$ A	max. 1,85	V
$V_{(TO)}$	$T_{vj} = 130$ °C	max. 1	V
r_T	$T_{vj} = 130$ °C	max. 5	mΩ
I_{RD}	$T_{vj} = 25$ °C; $V_{RD} = V_{RRM}$	max. 0,4	mA
I_{RD}	$T_{vj} = 130$ °C; $V_{RD} = V_{RRM}$	max. 30	mA
Q_{rr}	$T_{vj} = 130$ °C, $I_F = 50$ A,	75	μC
I_{RM}	$-di/dt = 50$ A/μs, $V_R = 30$ V	70	A
t_{rr}		2140	ns
E_{rr}		1,12	mJ
$R_{th(j-c)}$	per diode / per module	0,7 / 0,35	K/W
$R_{th(c-s)}$	per diode / per module	0,2 / 0,1	K/W
T_{vj}		- 40 ... + 130	°C
T_{stg}		- 40 ... + 125	°C
V_{isol}	a. c. 50 Hz; r.m.s.; 1 s / 1 min.	3600 / 3000	V~
M_s	to heatsink	5 ± 15 %	Nm
M_t	to terminals	3 ± 15 %	Nm
a		5 * 9,81	m/s ²
m	approx.	120	g
Case	SKKD	A 10	
	SKMD	A 33	
	SKND	A 37	

勝特力材料 886-3-5753170
 勝特力电子(上海) 86-21-34970699
 勝特力电子(深圳) 86-755-83298787
[Http://www.100y.com.tw](http://www.100y.com.tw)

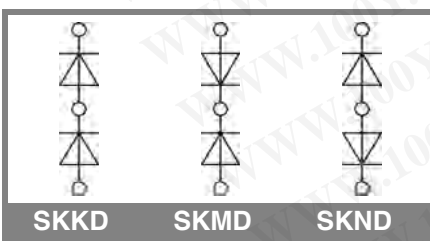

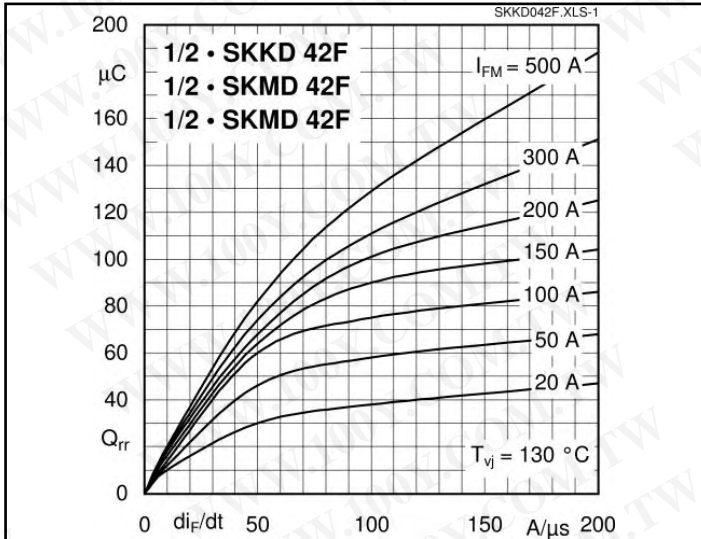

Fig. 1 Typ. recovery charge vs. current decrease

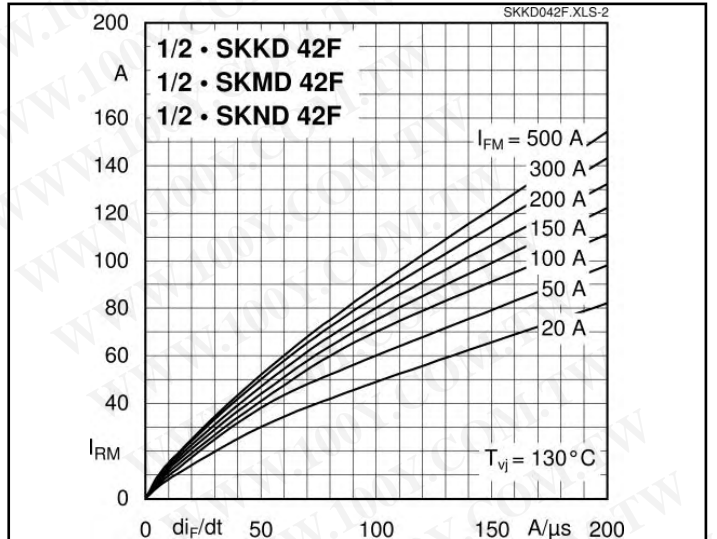

Fig. 2 Peak recovery current vs. current decrease

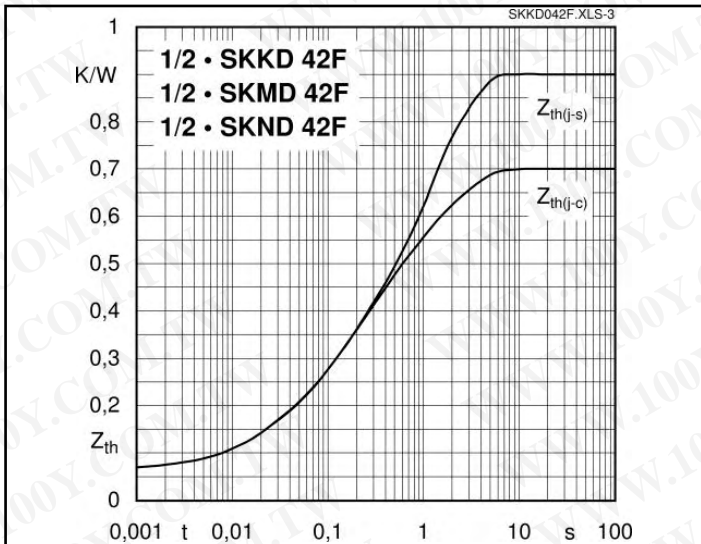

Fig. 3 Transient thermal impedance vs. time

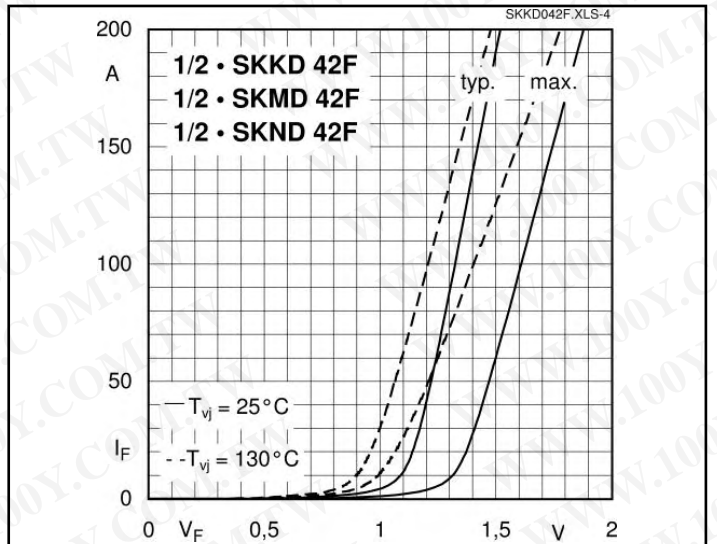

Fig. 4 Forward characteristics

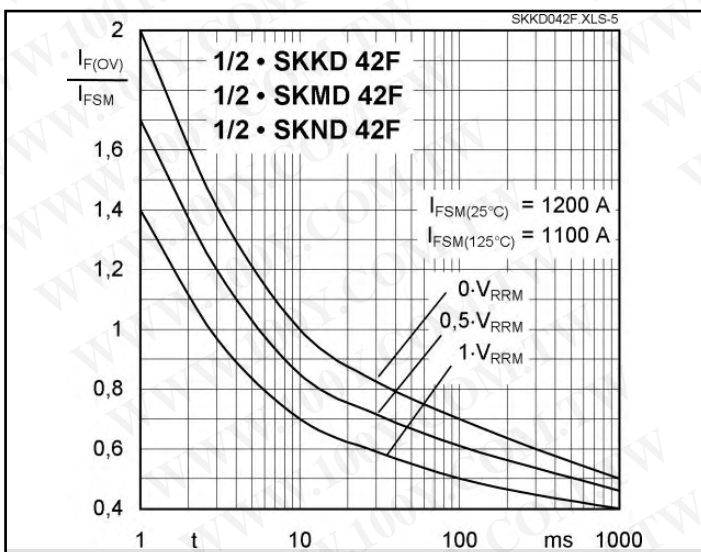
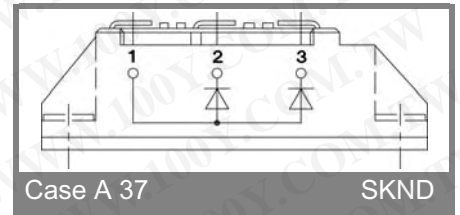
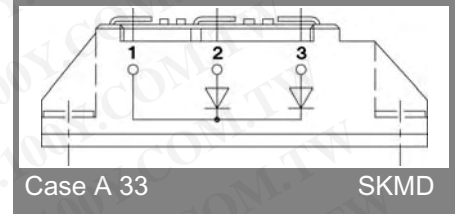
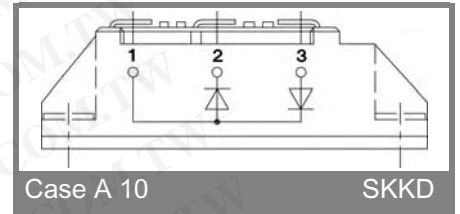
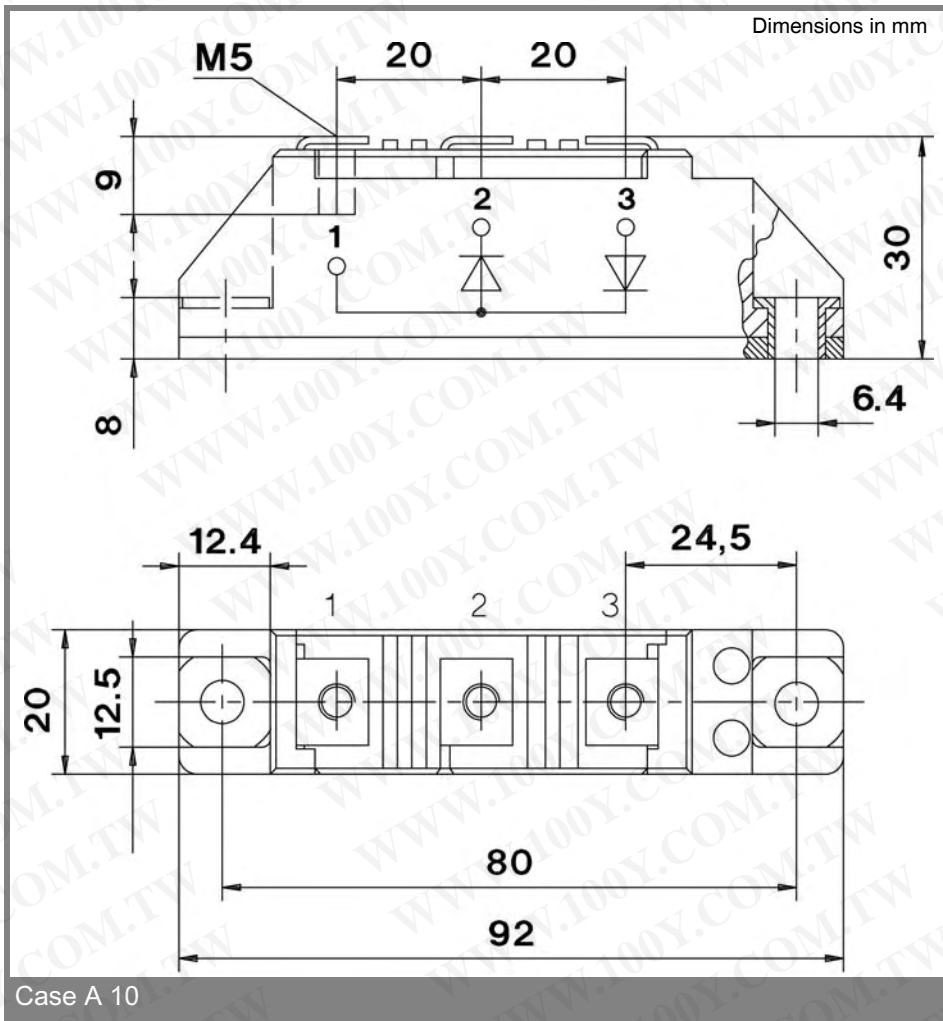

Fig. 5 Surge overload current vs. time

勝特力材料 886-3-5753170
 勝特力电子(上海) 86-21-34970699
 勝特力电子(深圳) 86-755-83298787
[Http://www.100y.com.tw](http://www.100y.com.tw)

SKKD 42F, SKMD 42F, SKND 42F



This technical information specifies semiconductor devices but promises no characteristics. No warranty or guarantee expressed or implied is made regarding delivery, performance or suitability.

勝特力材料 886-3-5753170
 勝特力电子(上海) 86-21-34970699
 勝特力电子(深圳) 86-755-83298787
[Http://www.100y.com.tw](http://www.100y.com.tw)