



STGB18N40LZ STGD18N40LZ, STGP18N40LZ

EAS 180 mJ - 390 V - internally clamped IGBT

Features

- AEC Q101 compliant
- 180 mJ of avalanche energy @ $T_C = 150^\circ\text{C}$, $L = 3\text{ mH}$
- ESD gate-emitter protection
- Gate-collector high voltage clamping
- Logic level gate drive
- Low saturation voltage
- High pulsed current capability
- Gate and gate-emitter resistor

Application

- Pencil coil electronic ignition driver

Description

This application-specific IGBT utilizes the most advanced PowerMESH™ technology. The built-in Zener diodes between gate-collector and gate-emitter provide overvoltage protection capabilities. The device also exhibits low on-state voltage drop and low threshold drive for use in automotive ignition system.

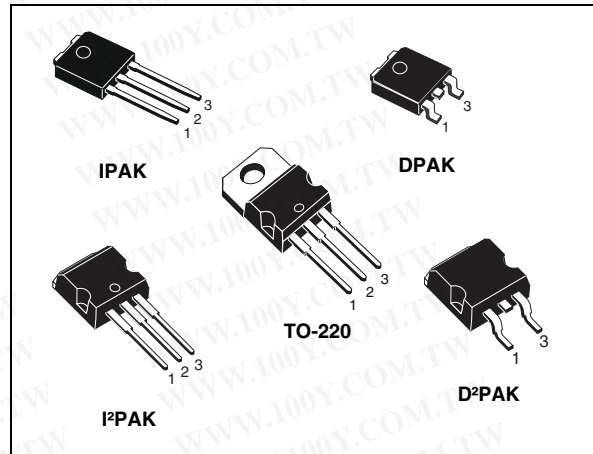

Figure 1. Internal schematic diagram

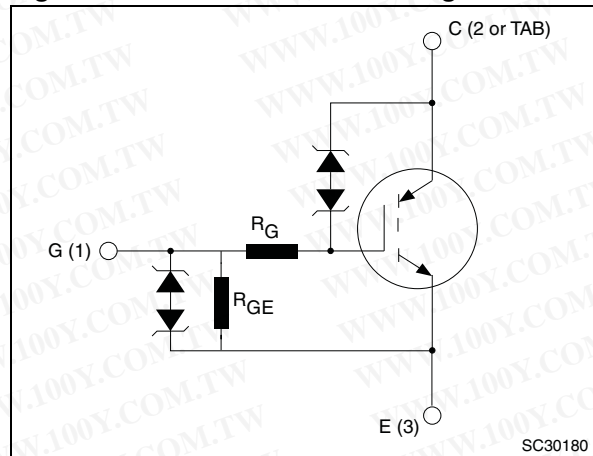

Table 1. Device summary

Order codes	Marking	Package	Packaging
STGB18N40LZ-1	GB18N40LZ	I ² PAK	Tube
STGB18N40LZT4	GB18N40LZ	D ² PAK	Tape and reel
STGD18N40LZ-1	GD18N40LZ	IPAK	Tube
STGD18N40LZT4	GD18N40LZ	DPAK	Tape and reel
STGP18N40LZ	GP18N40LZ	TO-220	Tube

Contents

1	Electrical ratings	3
2	Electrical characteristics	4
2.1	Electrical characteristics (curves)	6
3	Test circuits	9
4	Package mechanical data	10
5	Packaging mechanical data	16
6	Revision history	18



1 Electrical ratings

Table 2. Absolute maximum ratings

Symbol	Parameter	Value		Unit
		DPAK IPAK	D ² PAK I ² PAK, TO-220	
V _{CES}	Collector-emitter voltage (V _{GE} = 0)	V _{CES(clamped)}		V
V _{ECS}	Emitter collector voltage (V _{GE} = 0)	20		V
I _C ⁽¹⁾	Collector current (continuous) at T _C = 100 °C	25	30	A
I _{CP} ⁽²⁾	Pulsed collector current	40		A
V _{GE}	Gate-emitter voltage	V _{GE(clamped)}		V
P _{TOT}	Total dissipation at T _C = 25 °C	125	150	W
E _{AS}	Single pulse energy T _C = 25 °C, L = 3 mH, V _{CC} = 50 V	300		mJ
E _{AS}	Single pulse energy T _C =150 °C, L = 3 mH, V _{CC} = 50 V	180		mJ
ESD	Human body model, R= 1.5 kΩ, C = 100 pF	8		kV
	Machine model, R = 0, C = 100 pF	800		V
	Charged device model	2		kV
T _{stg}	Storage temperature	- 55 to 175		°C
T _j	Operating junction temperature			

1. Calculated according to the iterative formula

$$I_C(T_C) = \frac{T_{j(max)} - T_C}{R_{thj-c} \times V_{CE(sat)(max)}(T_{j(max)}, I_C(T_C))}$$

2. Pulse width limited by max. junction temperature allowed

Table 3. Thermal data

Symbol	Parameter	Value		Unit
		DPAK IPAK	D ² PAK I ² PAK, TO-220	
R _{thj-case}	Thermal resistance junction-case	1.2	1	°C/W
R _{thj-amb}	Thermal resistance junction-ambient	100	62.5	°C/W

2 Electrical characteristics

($T_J=25\text{ °C}$ unless otherwise specified)

Table 4. Static electrical characteristics

Symbol	Parameter	Test conditions	Min.	Typ.	Max.	Unit
$V_{CES(\text{clamped})}$	Collector emitter clamped voltage ($V_{GE} = 0$)	$I_C = 2\text{ mA}$ $T_J = -40\text{ °C to }150\text{ °C}$	360	390	420	V
$V_{(BR)ECS}$	Emitter collector break-down voltage ($V_{GE} = 0$)	$I_C = 75\text{ mA}$	20	28		V
$V_{GE(\text{clamped})}$	Gate emitter clamped voltage	$I_G = \pm 2\text{ mA}$	12		16	V
I_{CES}	Collector cut-off current ($V_{GE} = 0$)	$V_{CE} = 15\text{ V}, T_J = 150\text{ °C}$			10	μA
		$V_{CE} = 200\text{ V}, T_J = 150\text{ °C}$			100	μA
I_{GES}	Gate-emitter leakage current ($V_{CE} = 0$)	$V_{GE} = \pm 10\text{ V}$	450	625	830	μA
R_{GE}	Gate emitter resistance		12	16	22	k Ω
R_G	Gate resistance			1.6		k Ω
$V_{GE(\text{th})}$	Gate threshold voltage	$V_{GE} = V_{CE}, I_C = 1\text{ mA}, T_J = -40\text{ °C}$	1.4			V
		$V_{GE} = V_{CE}, I_C = 1\text{ mA}$	1.2	1.6	2.3	V
		$V_{GE} = V_{CE}, I_C = 1\text{ mA}, T_J = 150\text{ °C}$	0.7			V
$V_{CE(\text{sat})}$	Collector emitter saturation voltage	$V_{GE} = 4.5\text{ V}, I_C = 10\text{ A}$		1.35	1.7	V
		$V_{GE} = 4.5\text{ V}, I_C = 10\text{ A}, T_J = 150\text{ °C}$		1.30		V
		$V_{GE} = 3.8\text{ V}, I_C = 6\text{ A}$		1.30		V

Table 5. Dynamic electrical characteristics

Symbol	Parameter	Test conditions	Min.	Typ.	Max.	Unit
C_{ies}	Input capacitance	$V_{CE} = 25\text{ V}, f = 1\text{ MHz}, V_{GE} = 0$	-	490	-	pF
C_{oes}	Output capacitance		-	90	-	pF
C_{res}	Reverse transfer capacitance		-	5	-	pF
Q_g	Gate charge	$V_{CE} = 280\text{ V}, I_C = 10\text{ A}, V_{GE} = 5\text{ V}$	-	29	-	nC

Table 6. Switching on/off

Symbol	Parameter	Test conditions	Min.	Typ.	Max.	Unit
$t_{d(on)}$ t_r	Resistive load Turn-on delay time	$V_{CC} = 14\text{ V}$, $R_L = 1\ \Omega$, $V_{GE} = 5\text{ V}$	-	0.65	-	μs
	Rise time			3.5		
$t_{d(on)}$ t_r	Resistive load Turn-on delay time	$V_{CC} = 14\text{ V}$, $R_L = 1\ \Omega$, $V_{GE} = 5\text{ V}$, $T_J = 150\text{ }^\circ\text{C}$	-	0.65	-	μs
	Rise time			3.8		
$t_{d(off)}$ t_f dv/dt	Inductive load Turn-off delay time	$V_{CC} = 300\text{ V}$, $L = 1\text{ mH}$ $I_C = 10\text{ A}$, $V_{GE} = 5\text{ V}$	-	13.5	-	μs
	Fall time			5.5		
	Turn-off voltage slope			105		
$t_{d(off)}$ t_f dv/dt	Inductive load Turn-off delay time	$V_{CC} = 300\text{ V}$, $L = 1\text{ mH}$ $I_C = 10\text{ A}$, $V_{GE} = 5\text{ V}$, $T_J = 150\text{ }^\circ\text{C}$	-	14.2	-	μs
	Fall time			8		
	Turn-off voltage slope			97		

2.1 Electrical characteristics (curves)

Figure 2. Collector-emitter on voltage vs temperature

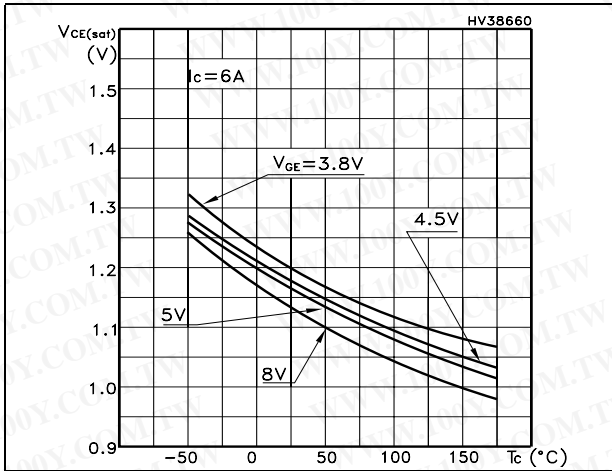

Figure 3. Collector-emitter on voltage vs temperature

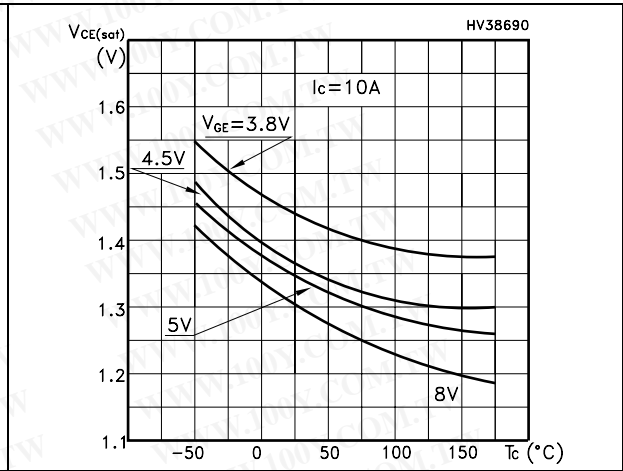

Figure 4. Collector-emitter on voltage vs temperature

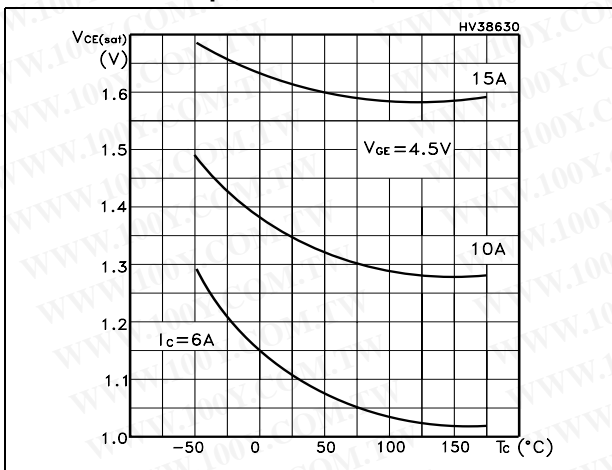

Figure 5. Self clamped inductive switch

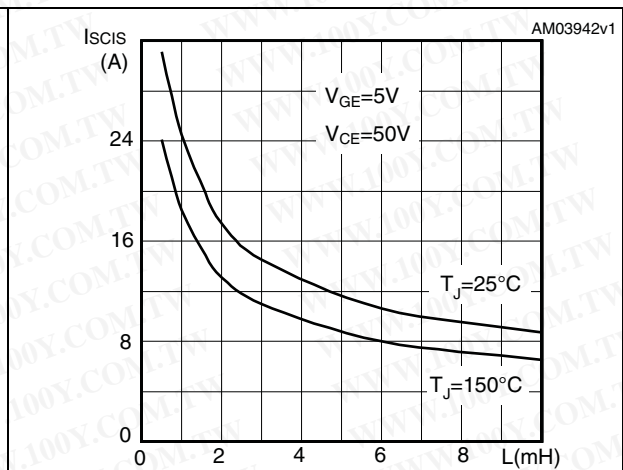

Figure 6. Output characteristics @ 25 °C

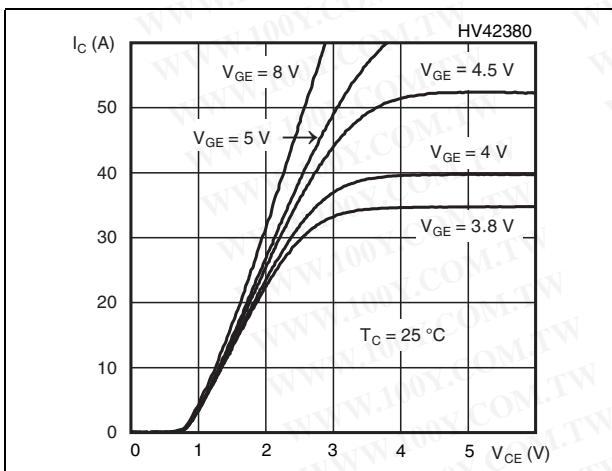

Figure 7. Output characteristics @ -40 °C

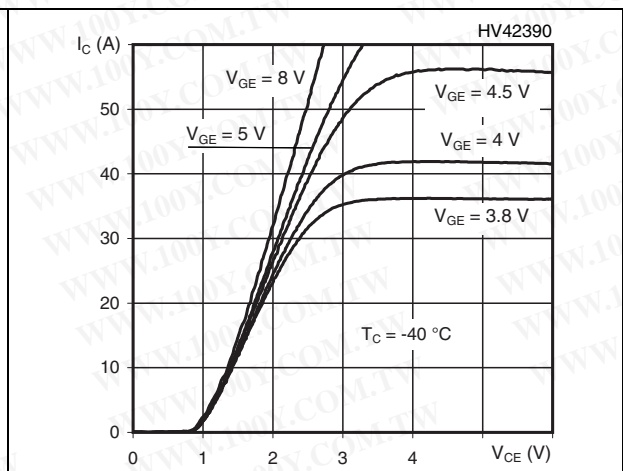

Figure 8. Output characteristics @ 175 °C

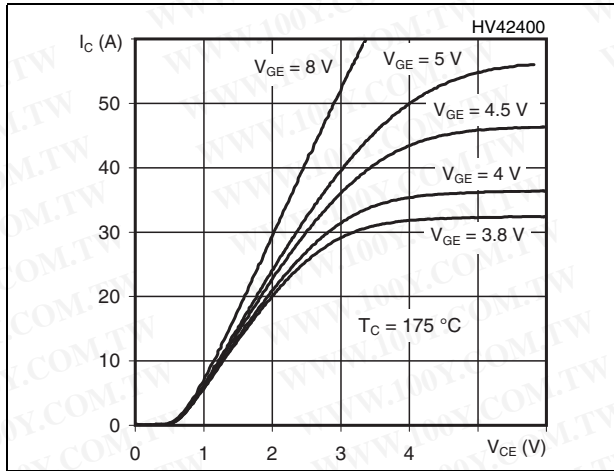

Figure 9. Transfer characteristics

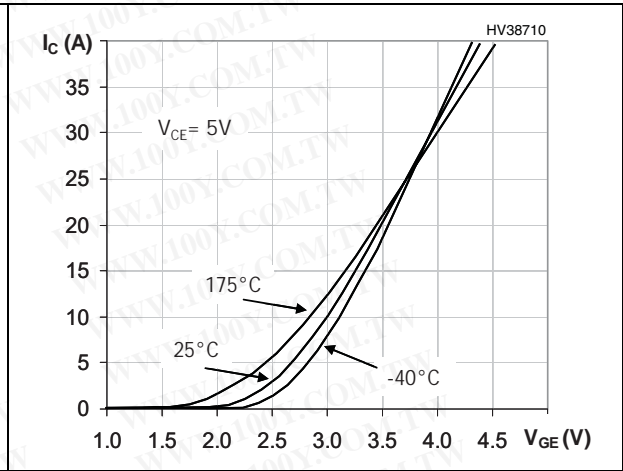

Figure 10. Collector cut-off current vs. temperature

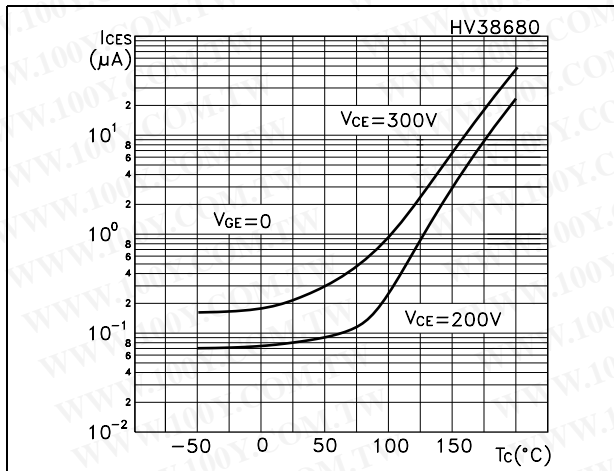

Figure 11. Normalized collector emitter voltage vs temperature

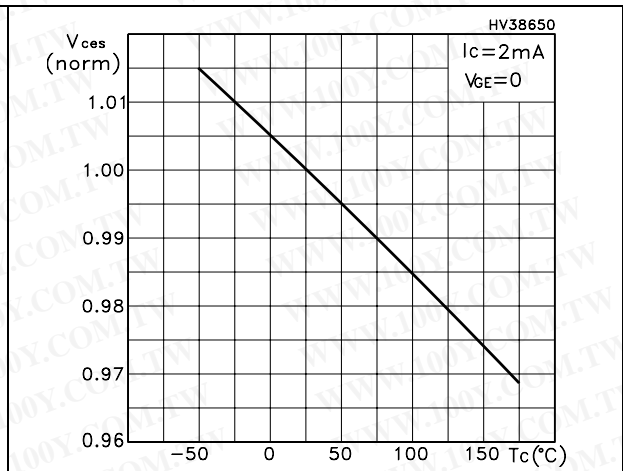

Figure 12. Normalized gate threshold voltage vs temperature

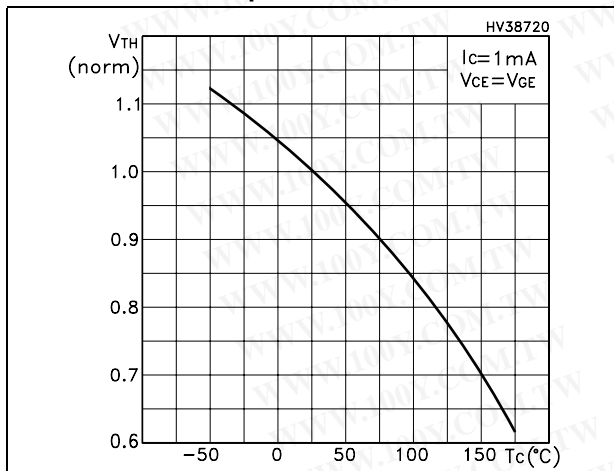

Figure 13. Normalized collector emitter on voltage vs temperature

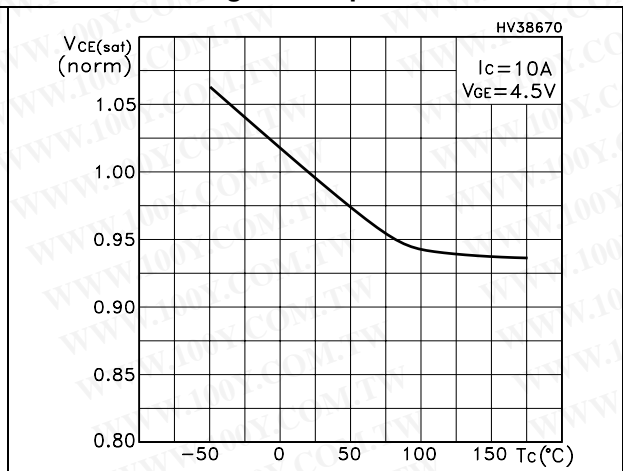

Figure 14. Thermal impedance for D²PAK, I²PAK, TO-220

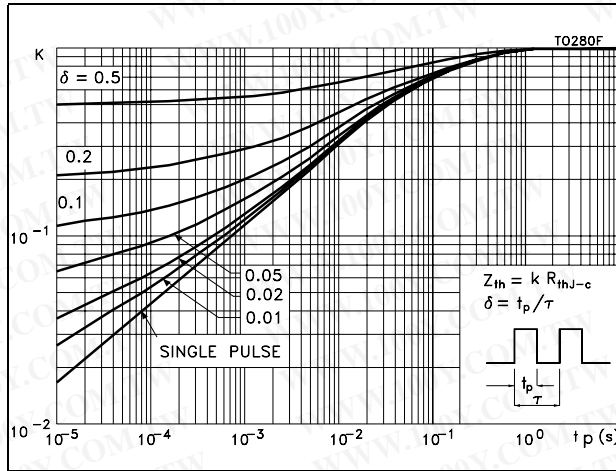
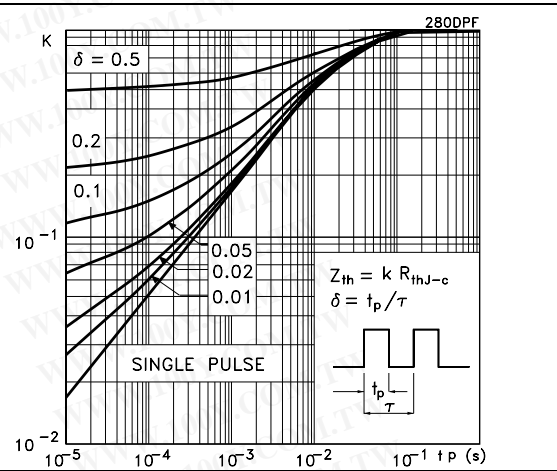

Figure 15. Thermal impedance for DPAK, IPAK



3 Test circuits

Figure 16. Inductive load switching

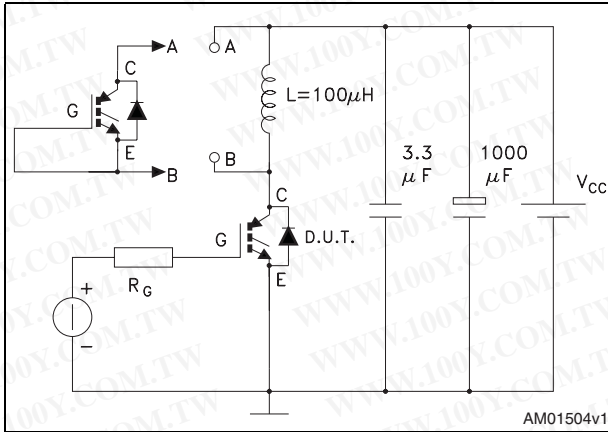

Figure 17. Resistive load switching

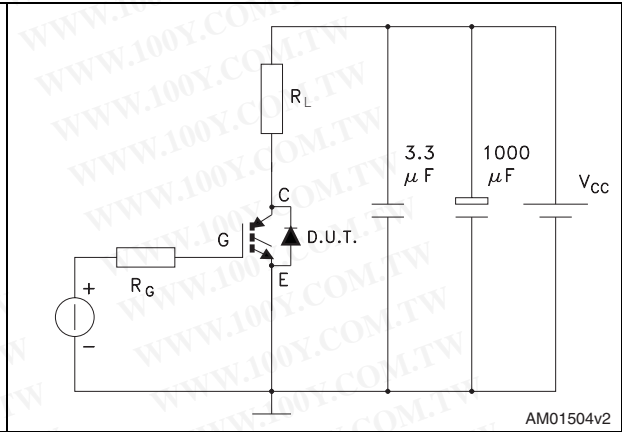

Figure 18. Gate charge test circuit

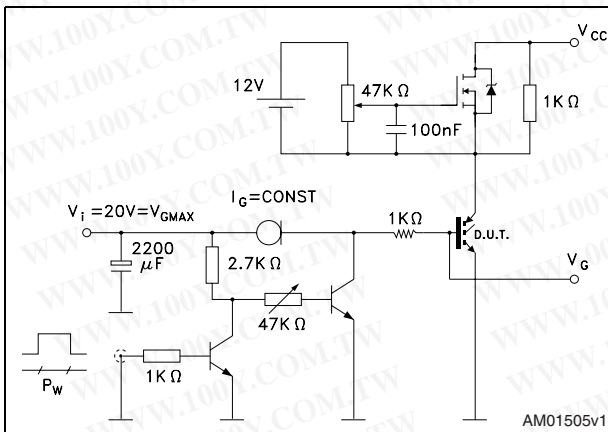
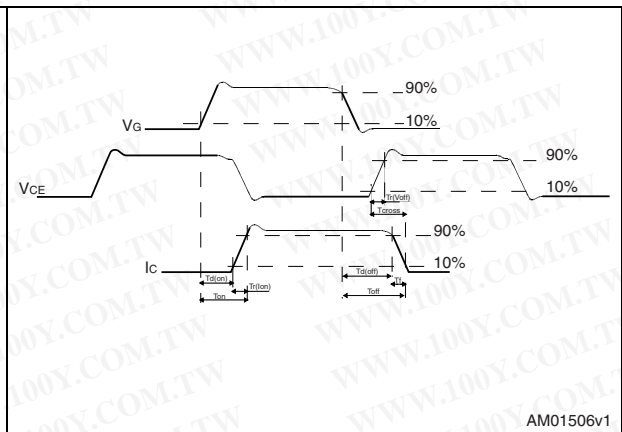

Figure 19. Switching waveform



4 Package mechanical data

In order to meet environmental requirements, ST offers these devices in different grades of ECOPACK® packages, depending on their level of environmental compliance. ECOPACK® specifications, grade definitions and product status are available at: www.st.com. ECOPACK is an ST trademark.

TO-252 (DPAK) mechanical data

DIM.	mm.		
	min.	typ	max.
A	2.20		2.40
A1	0.90		1.10
A2	0.03		0.23
b	0.64		0.90
b4	5.20		5.40
c	0.45		0.60
c2	0.48		0.60
D	6.00		6.20
D1		5.10	
E	6.40		6.60
E1		4.70	
e		2.28	
e1	4.40		4.60
H	9.35		10.10
L	1		
L1		2.80	
L2		0.80	
L4	0.60		1
R		0.20	
V2	0°		8°

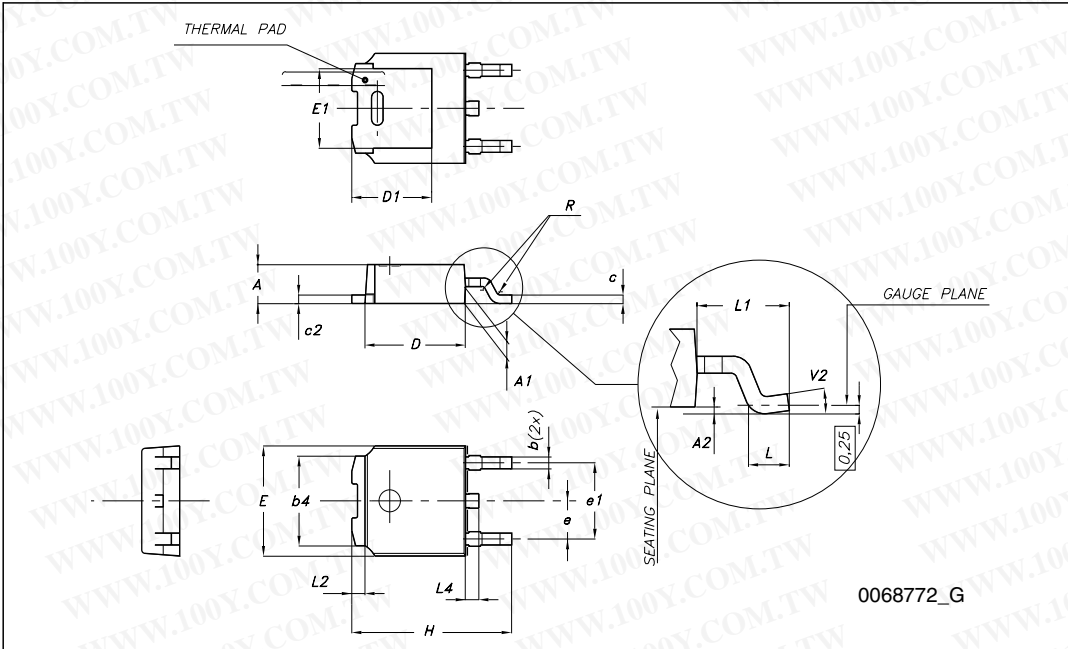

TO-251 (IPAK) mechanical data

DIM.	mm.		
	min.	typ	max.
A	2.20		2.40
A1	0.90		1.10
b	0.64		0.90
b2			0.95
b4	5.20		5.40
c	0.45		0.60
c2	0.48		0.60
D	6.00		6.20
E	6.40		6.60
e		2.28	
e1	4.40		4.60
H		16.10	
L	9.00		9.40
(L1)	0.80		1.20
L2		0.80	
V1		10°	

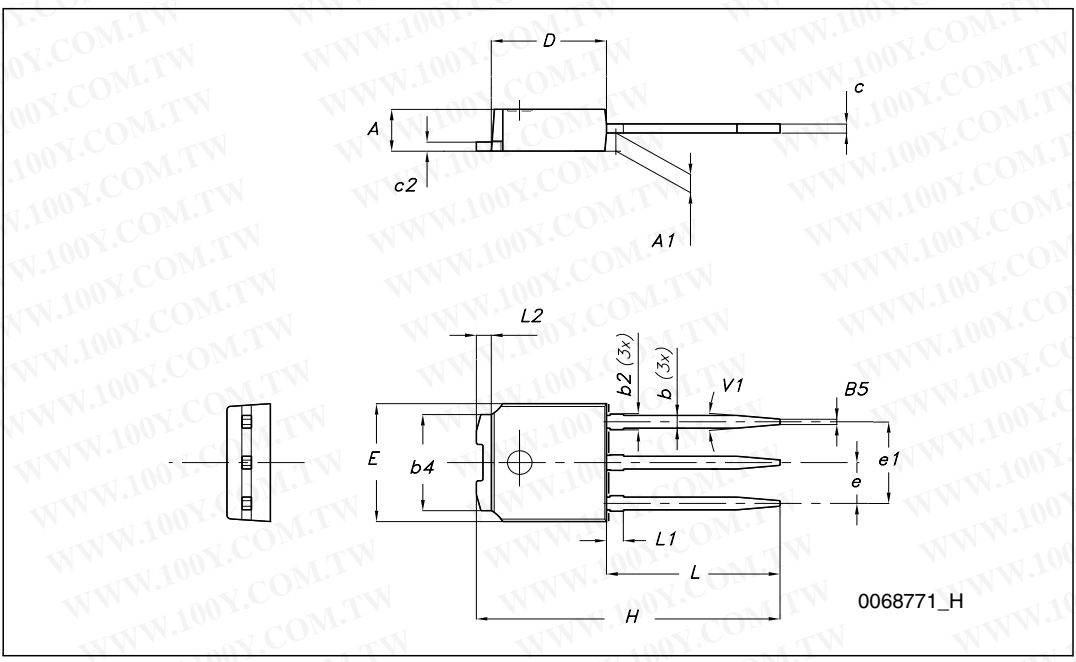

D²PAK (TO-263) mechanical data

Dim	mm			inch		
	Min	Typ	Max	Min	Typ	Max
A	4.40		4.60	0.173		0.181
A1	0.03		0.23	0.001		0.009
b	0.70		0.93	0.027		0.037
b2	1.14		1.70	0.045		0.067
c	0.45		0.60	0.017		0.024
c2	1.23		1.36	0.048		0.053
D	8.95		9.35	0.352		0.368
D1	7.50			0.295		
E	10		10.40	0.394		0.409
E1	8.50			0.334		
e		2.54			0.1	
e1	4.88		5.28	0.192		0.208
H	15		15.85	0.590		0.624
J1	2.49		2.69	0.099		0.106
L	2.29		2.79	0.090		0.110
L1	1.27		1.40	0.05		0.055
L2	1.30		1.75	0.051		0.069
R		0.4			0.016	
V2	0°		8°	0°		8°

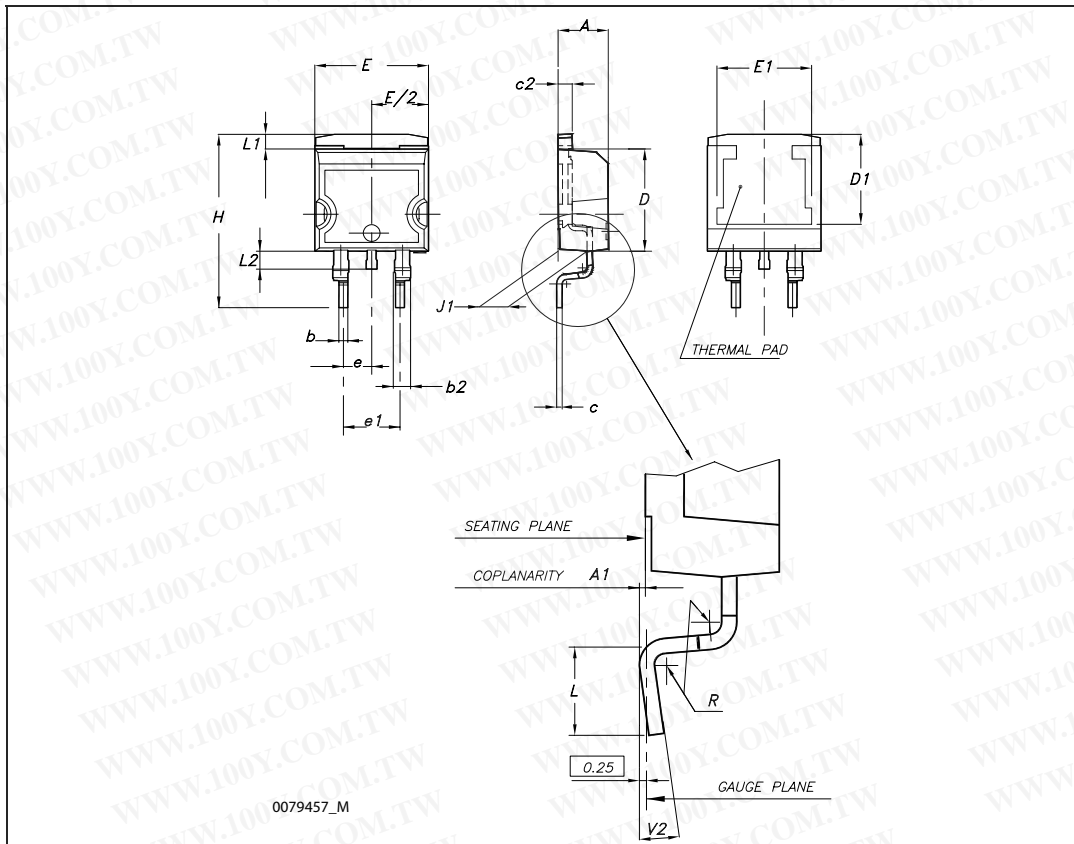

I²PAK (TO-262) mechanical data

Dim	mm			inch		
	Min	Typ	Max	Min	Typ	Max
A	4.40		4.60	0.173		0.181
A1	2.40		2.72	0.094		0.107
b	0.61		0.88	0.024		0.034
b1	1.14		1.70	0.044		0.066
c	0.49		0.70	0.019		0.027
c2	1.23		1.32	0.048		0.052
D	8.95		9.35	0.352		0.368
e	2.40		2.70	0.094		0.106
e1	4.95		5.15	0.194		0.202
E	10		10.40	0.393		0.410
L	13		14	0.511		0.551
L1	3.50		3.93	0.137		0.154
L2	1.27		1.40	0.050		0.055

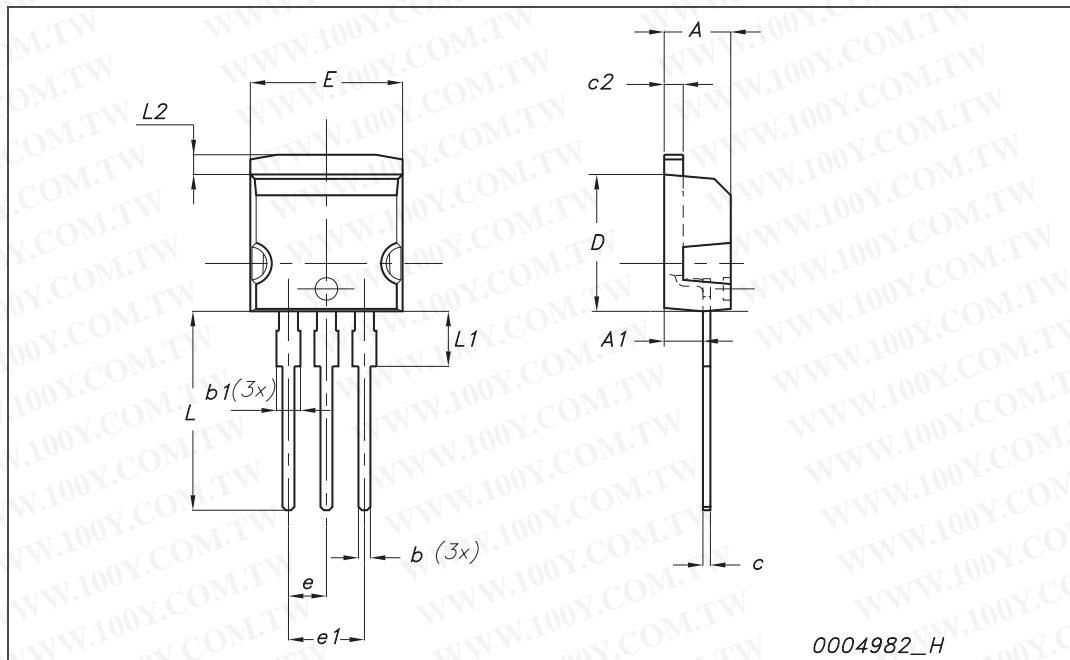

TO-220 mechanical data

Dim	mm			inch		
	Min	Typ	Max	Min	Typ	Max
A	4.40		4.60	0.173		0.181
b	0.61		0.88	0.024		0.034
b1	1.14		1.70	0.044		0.066
c	0.48		0.70	0.019		0.027
D	15.25		15.75	0.6		0.62
D1		1.27			0.050	
E	10		10.40	0.393		0.409
e	2.40		2.70	0.094		0.106
e1	4.95		5.15	0.194		0.202
F	1.23		1.32	0.048		0.051
H1	6.20		6.60	0.244		0.256
J1	2.40		2.72	0.094		0.107
L	13		14	0.511		0.551
L1	3.50		3.93	0.137		0.154
L20		16.40			0.645	
L30		28.90			1.137	
∅P	3.75		3.85	0.147		0.151
Q	2.65		2.95	0.104		0.116

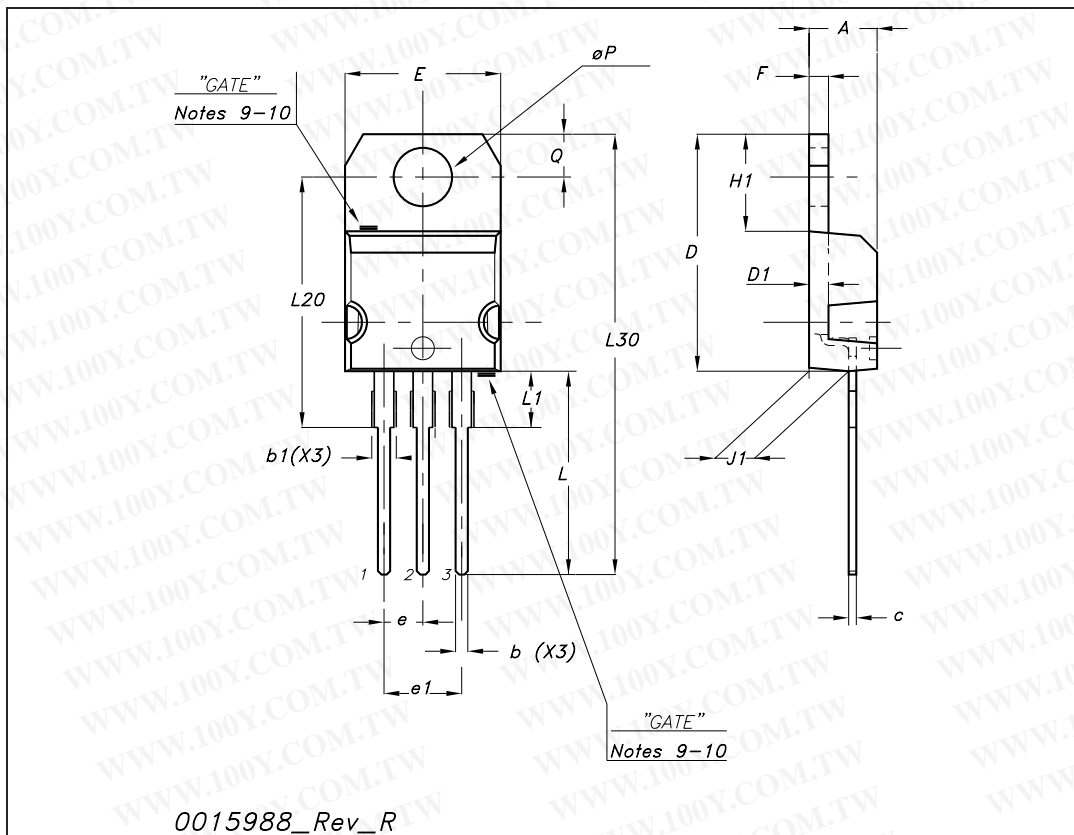

5 Packaging mechanical data

DPAK FOOTPRINT

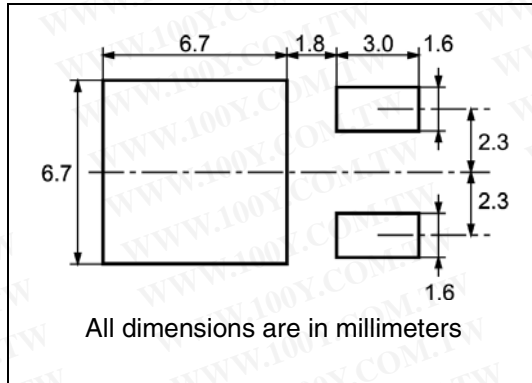

TAPE AND REEL SHIPMENT

DIM.	mm		inch	
	MIN.	MAX.	MIN.	MAX.
A		330		12.992
B	1.5		0.059	
C	12.8	13.2	0.504	0.520
D	20.2		0.795	
G	16.4	18.4	0.645	0.724
N	50		1.968	
T		22.4		0.881

DIM.	mm		inch	
	MIN.	MAX.	MIN.	MAX.
A0	6.8	7	0.267	0.275
B0	10.4	10.6	0.409	0.417
B1		12.1		0.476
D	1.5	1.6	0.059	0.063
D1	1.5		0.059	
E	1.65	1.85	0.065	0.073
F	7.4	7.6	0.291	0.299
K0	2.55	2.75	0.100	0.108
P0	3.9	4.1	0.153	0.161
P1	7.9	8.1	0.311	0.319
P2	1.9	2.1	0.075	0.082
R	40		1.574	
W	15.7	16.3	0.618	0.641

D²PAK FOOTPRINT

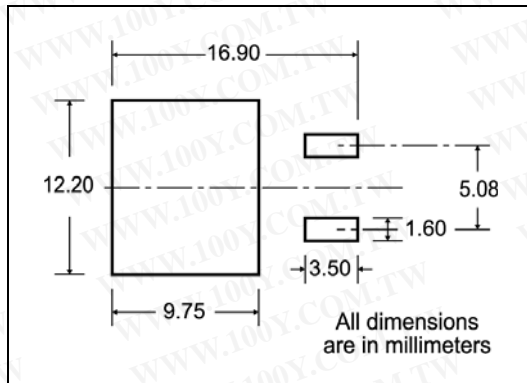

TAPE AND REEL SHIPMENT

TAPE MECHANICAL DATA

DIM.	mm		inch	
	MIN.	MAX.	MIN.	MAX.
A0	10.5	10.7	0.413	0.421
B0	15.7	15.9	0.618	0.626
D	1.5	1.6	0.059	0.063
D1	1.59	1.61	0.062	0.063
E	1.65	1.85	0.065	0.073
F	11.4	11.6	0.449	0.456
K0	4.8	5.0	0.189	0.197
P0	3.9	4.1	0.153	0.161
P1	11.9	12.1	0.468	0.476
P2	1.9	2.1	0.075	0.082
R	50		1.574	
T	0.25	0.35	0.0098	0.0137
W	23.7	24.3	0.933	0.956

REEL MECHANICAL DATA

DIM.	mm		inch	
	MIN.	MAX.	MIN.	MAX.
A		330		12.992
B	1.5		0.059	
C	12.8	13.2	0.504	0.520
D	20.2		0.795	
G	24.4	26.4	0.960	1.039
N	100		3.937	
T		30.4		1.197

BASE QTY	BULK QTY
1000	1000

TRL

* on sales type

6 Revision history

Table 7. Document revision history

Date	Revision	Changes
18-Jan-2008	1	Initial release.
07-Mar-2008	2	Modified Figure 7 , Figure 8 , Figure 10 .
07-May-2008	3	Modified Figure 9
31-Mar-2009	4	Added new package, mechanical data: TO-220
18-May-2009	5	Modified Figure 5

勝特力材料 886-3-5753170
勝特力电子(上海) 86-21-34970699
勝特力电子(深圳) 86-755-83298787
[Http://www.100y.com.tw](http://www.100y.com.tw)

Please Read Carefully:

Information in this document is provided solely in connection with ST products. STMicroelectronics NV and its subsidiaries ("ST") reserve the right to make changes, corrections, modifications or improvements, to this document, and the products and services described herein at any time, without notice.

All ST products are sold pursuant to ST's terms and conditions of sale.

Purchasers are solely responsible for the choice, selection and use of the ST products and services described herein, and ST assumes no liability whatsoever relating to the choice, selection or use of the ST products and services described herein.

No license, express or implied, by estoppel or otherwise, to any intellectual property rights is granted under this document. If any part of this document refers to any third party products or services it shall not be deemed a license grant by ST for the use of such third party products or services, or any intellectual property contained therein or considered as a warranty covering the use in any manner whatsoever of such third party products or services or any intellectual property contained therein.

UNLESS OTHERWISE SET FORTH IN ST'S TERMS AND CONDITIONS OF SALE ST DISCLAIMS ANY EXPRESS OR IMPLIED WARRANTY WITH RESPECT TO THE USE AND/OR SALE OF ST PRODUCTS INCLUDING WITHOUT LIMITATION IMPLIED WARRANTIES OF MERCHANTABILITY, FITNESS FOR A PARTICULAR PURPOSE (AND THEIR EQUIVALENTS UNDER THE LAWS OF ANY JURISDICTION), OR INFRINGEMENT OF ANY PATENT, COPYRIGHT OR OTHER INTELLECTUAL PROPERTY RIGHT.

UNLESS EXPRESSLY APPROVED IN WRITING BY AN AUTHORIZED ST REPRESENTATIVE, ST PRODUCTS ARE NOT RECOMMENDED, AUTHORIZED OR WARRANTED FOR USE IN MILITARY, AIR CRAFT, SPACE, LIFE SAVING, OR LIFE SUSTAINING APPLICATIONS, NOR IN PRODUCTS OR SYSTEMS WHERE FAILURE OR MALFUNCTION MAY RESULT IN PERSONAL INJURY, DEATH, OR SEVERE PROPERTY OR ENVIRONMENTAL DAMAGE. ST PRODUCTS WHICH ARE NOT SPECIFIED AS "AUTOMOTIVE GRADE" MAY ONLY BE USED IN AUTOMOTIVE APPLICATIONS AT USER'S OWN RISK.

Resale of ST products with provisions different from the statements and/or technical features set forth in this document shall immediately void any warranty granted by ST for the ST product or service described herein and shall not create or extend in any manner whatsoever, any liability of ST.

ST and the ST logo are trademarks or registered trademarks of ST in various countries.

Information in this document supersedes and replaces all information previously supplied.

The ST logo is a registered trademark of STMicroelectronics. All other names are the property of their respective owners.

© 2009 STMicroelectronics - All rights reserved

STMicroelectronics group of companies

Australia - Belgium - Brazil - Canada - China - Czech Republic - Finland - France - Germany - Hong Kong - India - Israel - Italy - Japan - Malaysia - Malta - Morocco - Philippines - Singapore - Spain - Sweden - Switzerland - United Kingdom - United States of America

www.st.com

