



STPS30L60C

Power Schottky rectifier

Features

- Low forward voltage drop
- Negligible switching losses
- Low thermal resistance
- Avalanche capability specified

Description

These dual center tap Schottky rectifiers are suited for switched mode power supplies and high frequency DC to DC converters.

Packaged in TO-220FPAB, TO-220, D²PAK, I²PAK and TO-247, this device is intended for use in high frequency inverters.

Figure 1. Electrical characteristics (a)

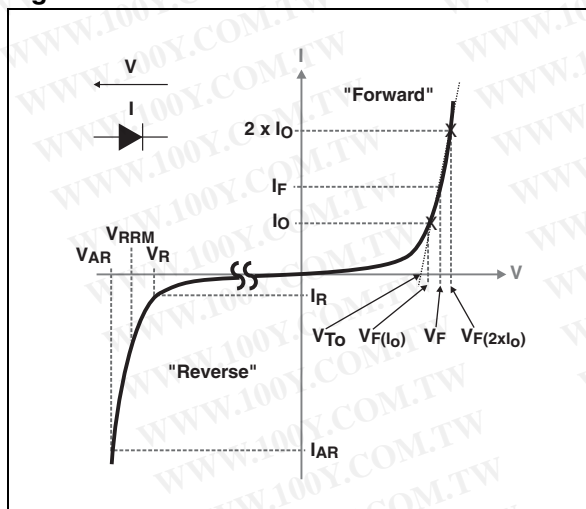

- a. V_{ARM} and I_{ARM} must respect the reverse safe operating area defined in Figure 14. V_{AR} and I_{AR} are pulse measurements ($t_p < 1 \mu s$). V_R , I_R , V_{RRM} and V_F are static characteristics

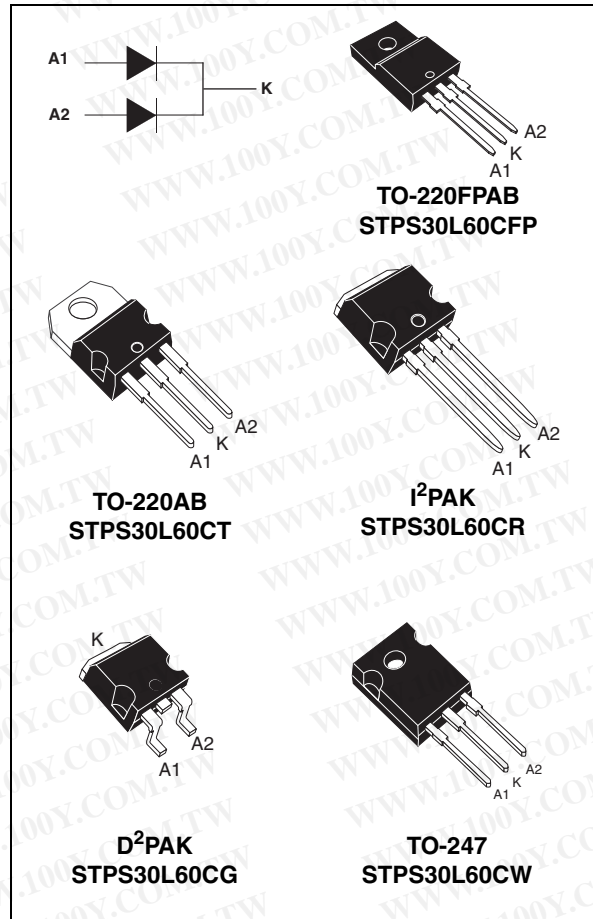

Table 1. Device summary

Symbol	Value
$I_{F(AV)}$	2 x 15 A
V_{RRM}	60 V
$T_j(max)$	150 °C
$V_F(max)$	0.56 V

1 Characteristics

Table 2. Absolute ratings (limiting values, per diode)

Symbol	Parameter			Value	Unit	
V _{RRM}	Repetitive peak reverse voltage			60	V	
I _{F(RMS)}	Forward rms current			30	A	
I _{F(AV)}	Average forward current	TO-220AB, I ² PAK, D ² PAK, TO-247, δ = 0.5	T _c = 130 °C	Per diode Per device	15 30	A
		TO-220FPAB, δ = 0.5	T _c = 110 °C	Per diode Per device	15 30	
I _{FSM}	Surge non repetitive forward current		t _p = 10 ms, sinusoidal	230	A	
I _{RRM}	Repetitive peak reverse current		t _p = 2 μs square, F = 1 kHz	2	A	
P _{ARM} ⁽¹⁾	Repetitive peak avalanche power		t _p = 1 μs, T _j = 25 °C	7800	W	
V _{ARM} ⁽²⁾	Maximum repetitive peak avalanche voltage		t _p < 1 μs, T _j < 150 °C, I _{AR} < 29 A	80	V	
V _{ASM} ⁽²⁾	Maximum single pulse peak avalanche voltage		t _p < 1 μs, T _j < 150 °C, I _{AR} < 29 A	80	V	
T _{stg}	Storage temperature range			-65 to + 175	°C	
T _j	Maximum operating junction temperature ⁽³⁾			150	°C	
dV/dt	Critical rate of rise reverse voltage			10000	V/μs	

- For temperature or pulse time duration deratings, refer to [Figure 4](#) and [Figure 5](#). More details regarding the avalanche energy measurements and diode validation in the avalanche are provided in the application notes AN1768 and AN2025.
- Refer to [Figure 14](#).
- $\frac{dP_{tot}}{dT_j} < \frac{1}{R_{th(j-a)}}$ condition to avoid thermal runaway for a diode on its own heatsink

Table 3. Thermal resistances

Symbol	Parameter			Value	Unit
R _{th(j-c)}	Junction to case	TO-220AB, I ² PAK, D ² PAK, TO-247	Per diode	1.5	°C/W
			Total	0.8	
		TO-220FPAB	Per diode	4.7	
			Total	3.95	
R _{th(c)}	Coupling	TO-220AB, I ² PAK, D ² PAK, TO-247	0.1		
		TO-220FPAB	3.2		

When the diodes 1 and 2 are used simultaneously:

$$\Delta T_j(\text{diode 1}) = P(\text{diode1}) \times R_{th(j-c)}(\text{Per diode}) + P(\text{diode 2}) \times R_{th(c)}$$

Table 4. Static electrical characteristics (per diode)

Symbol	Parameter	Tests conditions		Min.	Typ.	Max.	Unit
$I_R^{(1)}$	Reverse leakage current	$T_j = 25\text{ }^\circ\text{C}$	$V_R = V_{RRM}$			480	μA
		$T_j = 125\text{ }^\circ\text{C}$			77	130	mA
$V_F^{(1)}$	Forward voltage drop	$T_j = 25\text{ }^\circ\text{C}$	$I_F = 15\text{ A}$			0.6	V
		$T_j = 125\text{ }^\circ\text{C}$	$I_F = 15\text{ A}$		0.5	0.56	
		$T_j = 25\text{ }^\circ\text{C}$	$I_F = 30\text{ A}$			0.75	
		$T_j = 125\text{ }^\circ\text{C}$	$I_F = 30\text{ A}$		0.65	0.7	

1. Pulse test : $t_p = 380\text{ }\mu\text{s}$, $\delta < 2\%$

To evaluate the conduction losses use the following equation : $P = 0.42 \times I_{F(AV)} + 0.009 \times I_F^2(RMS)$

Figure 2. Average forward power dissipation versus average forward current (per diode)

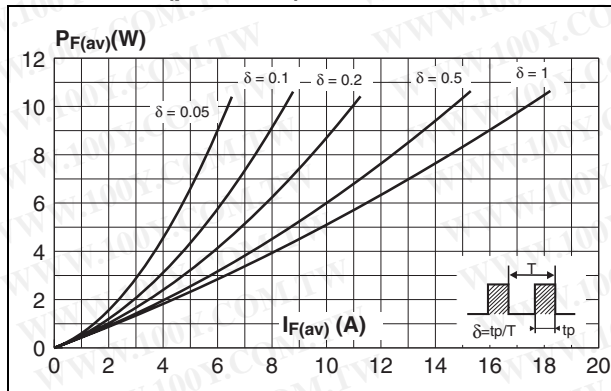

Figure 3. Average forward current versus ambient temperature (delta = 0.5, per diode)

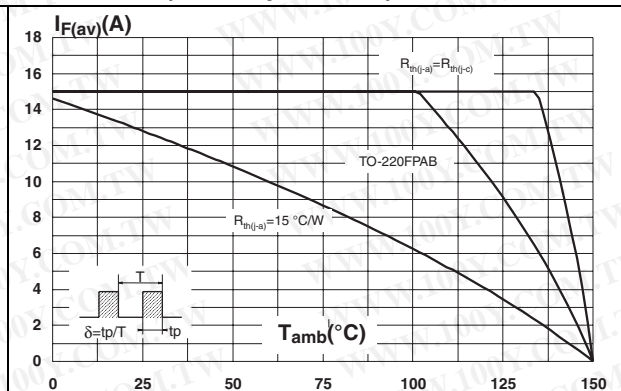

Figure 4. Normalized avalanche power derating versus pulse duration

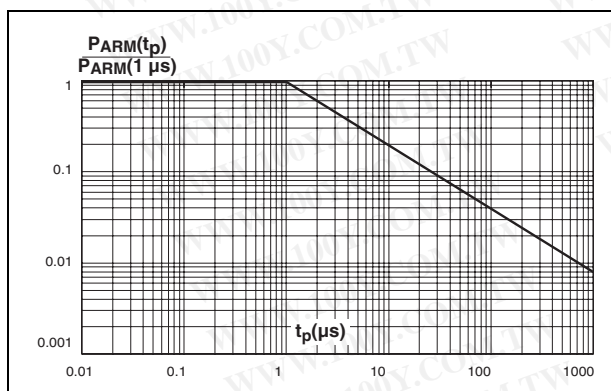

Figure 5. Normalized avalanche power derating versus junction temperature

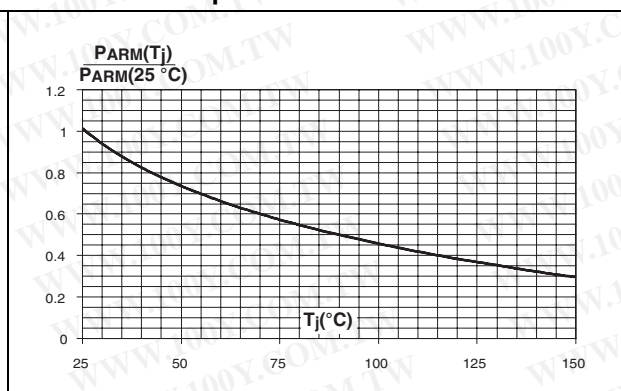

Figure 6. Non repetitive surge peak forward current versus overload duration

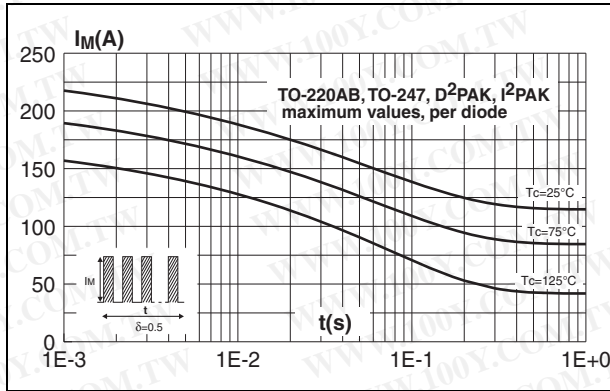

Figure 7. Non repetitive surge peak forward current versus overload duration (TO-220FPAB)

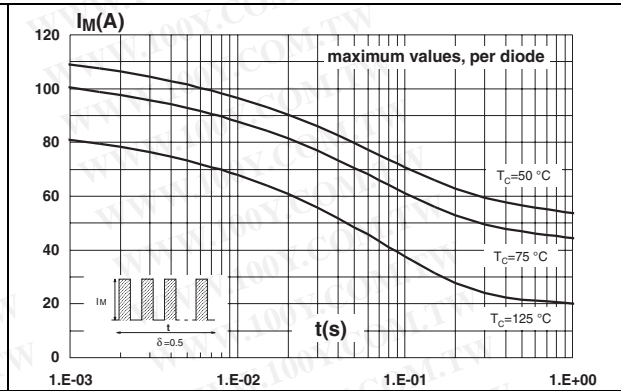

Figure 8. Relative variation of thermal impedance junction to case versus pulse duration

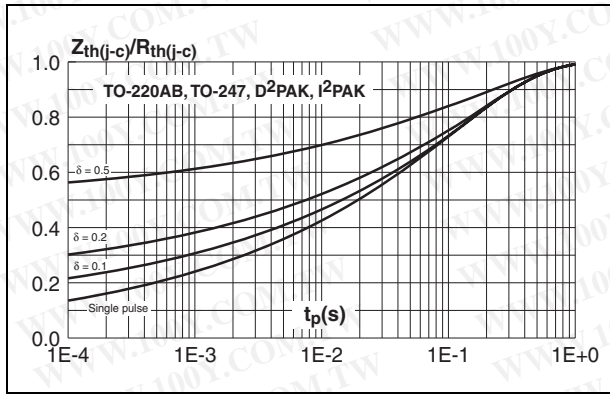

Figure 9. Relative variation of thermal impedance junction to case versus pulse duration (TO-220FPAB)

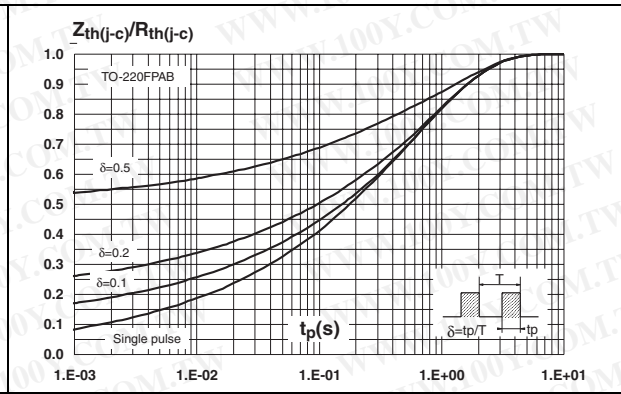

Figure 10. Reverse leakage current versus reverse voltage applied (typical values, per diode)

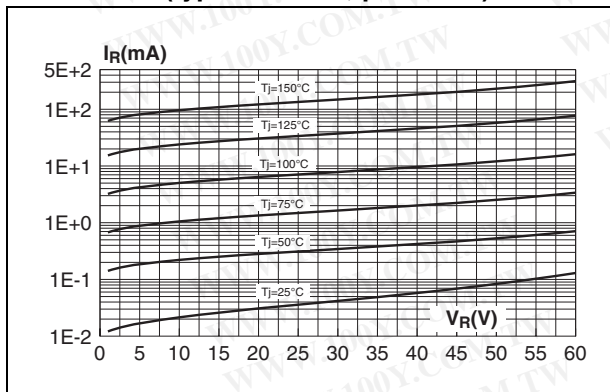

Figure 11. Junction capacitance versus reverse voltage applied (typical values, per diode)

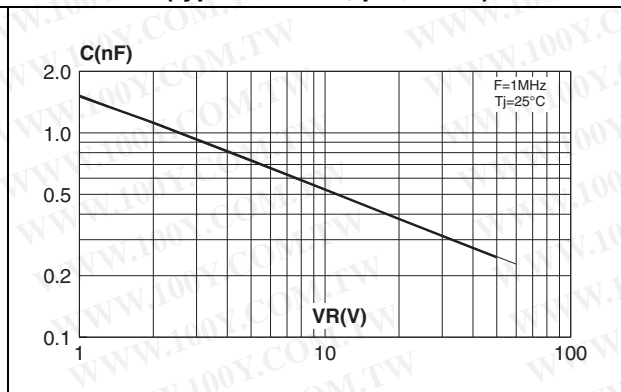

Figure 12. Forward voltage drop versus forward current (maximum values, per diode)

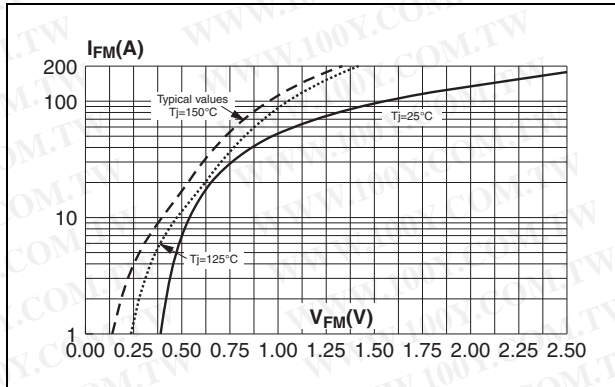

Figure 13. Thermal resistance junction to ambient versus D²PAK copper surface area under tab

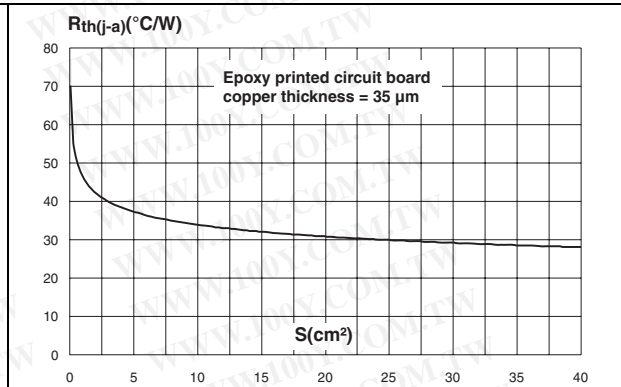
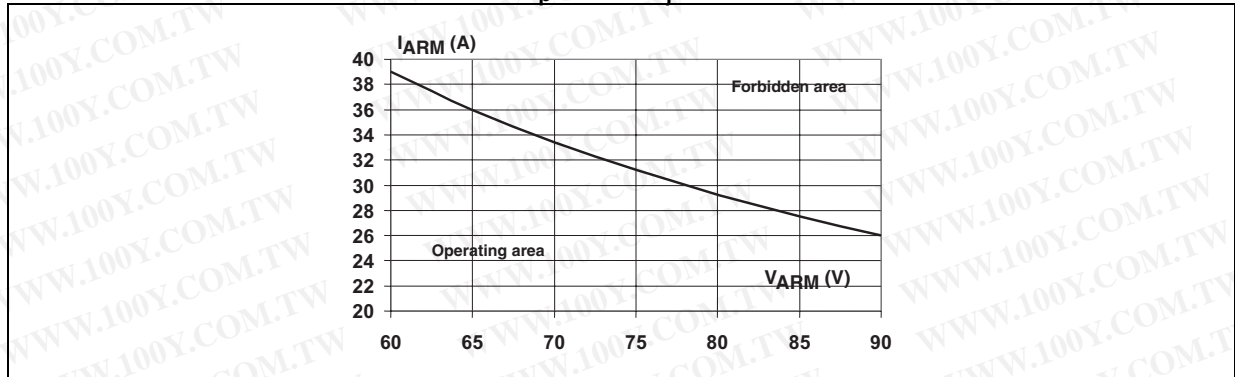

Figure 14. Reverse safe operating area ($t_p < 1\ \mu\text{s}$, $T_j < 150^\circ\text{C}$)



2 Package information

- Epoxy meets UL94, V0
- Cooling method: by conduction (C)
- Recommended torque values: TO-220AB and TO-220FPAB 0.4 to 0.6 N·m, TO-247 0.55 N·m (1.0 N·m maximum)

In order to meet environmental requirements, ST offers these devices in different grades of ECOPACK® packages, depending on their level of environmental compliance. ECOPACK® specifications, grade definitions and product status are available at: www.st.com. ECOPACK® is an ST trademark.

Table 5. TO-220FPAB dimensions

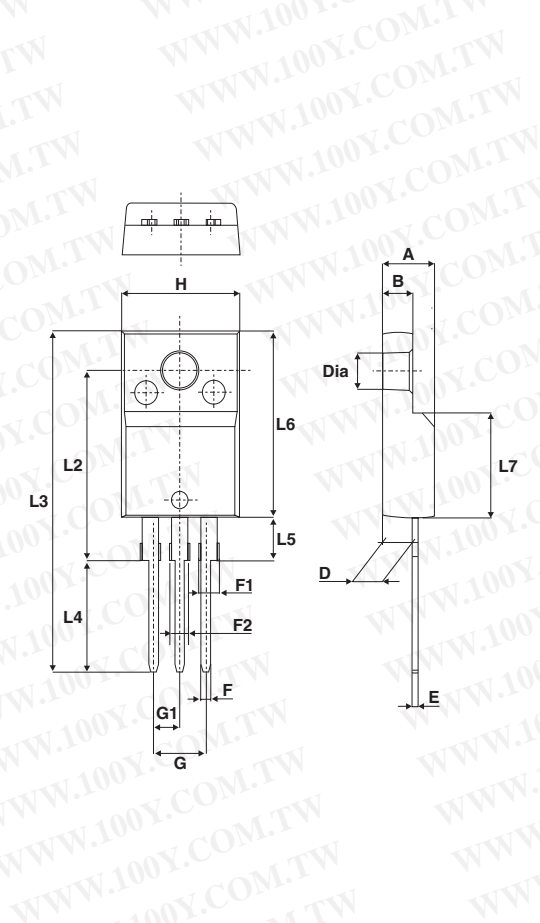

Ref.	Dimensions			
	Millimeters		Inches	
	Min.	Max.	Min.	Max.
A	4.4	4.6	0.173	0.181
B	2.5	2.7	0.098	0.106
D	2.5	2.75	0.098	0.108
E	0.45	0.70	0.018	0.027
F	0.75	1	0.030	0.039
F1	1.15	1.70	0.045	0.067
F2	1.15	1.70	0.045	0.067
G	4.95	5.20	0.195	0.205
G1	2.4	2.7	0.094	0.106
H	10	10.4	0.393	0.409
L2	16 Typ.		0.63 Typ.	
L3	28.6	30.6	1.126	1.205
L4	9.8	10.6	0.386	0.417
L5	2.9	3.6	0.114	0.142
L6	15.9	16.4	0.626	0.646
L7	9.00	9.30	0.354	0.366
Dia.	3.00	3.20	0.118	0.126

Table 6. TO-220AB dimensions

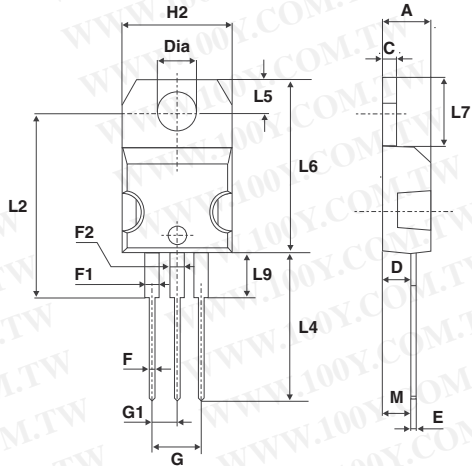

Ref.	Dimensions			
	Millimeters		Inches	
	Min.	Max.	Min.	Max.
A	4.40	4.60	0.173	0.181
C	1.23	1.32	0.048	0.051
D	2.40	2.72	0.094	0.107
E	0.49	0.70	0.019	0.027
F	0.61	0.88	0.024	0.034
F1	1.14	1.70	0.044	0.067
F2	1.14	1.70	0.044	0.06è
G	4.95	5.15	0.194	0.202
G1	2.40	2.70	0.094	0.106
H2	10	10.40	0.393	0.409
L2	16.4 typ.		0.645 typ.	
L4	13	14	0.511	0.551
L5	2.65	2.95	0.104	0.116
L6	15.25	15.75	0.600	0.620
L7	6.20	6.60	0.244	0.259
L9	3.50	3.93	0.137	0.154
M	2.6 typ.		0.102 typ.	
Diam.	3.75	3.85	0.147	0.151

Table 7. D²PAK dimensions

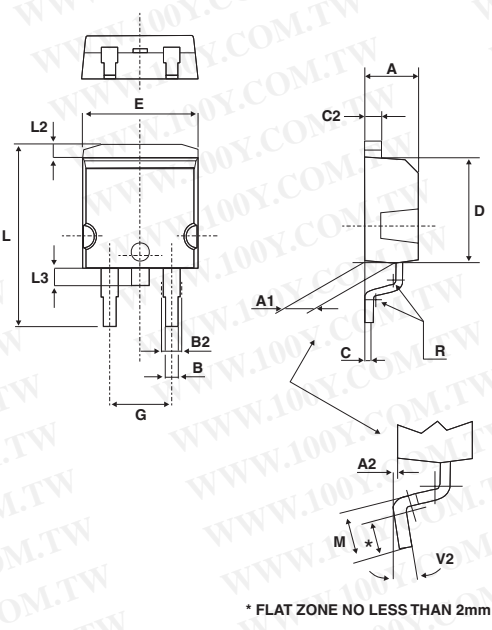

Ref.	Dimensions			
	Millimeters		Inches	
	Min.	Max.	Min.	Max.
A	4.40	4.60	0.173	0.181
A1	2.49	2.69	0.098	0.106
A2	0.03	0.23	0.001	0.009
B	0.70	0.93	0.027	0.037
B2	1.14	1.70	0.045	0.067
C	0.45	0.60	0.017	0.024
C2	1.23	1.36	0.048	0.054
D	8.95	9.35	0.352	0.368
E	10.00	10.40	0.393	0.409
G	4.88	5.28	0.192	0.208
L	15.00	15.85	0.590	0.624
L2	1.27	1.40	0.050	0.055
L3	1.40	1.75	0.055	0.069
M	2.40	3.20	0.094	0.126
R	0.40 typ.		0.016 typ.	
V2	0°	8°	0°	8°

* FLAT ZONE NO LESS THAN 2mm

Figure 15. Footprint (dimensions in millimeters)

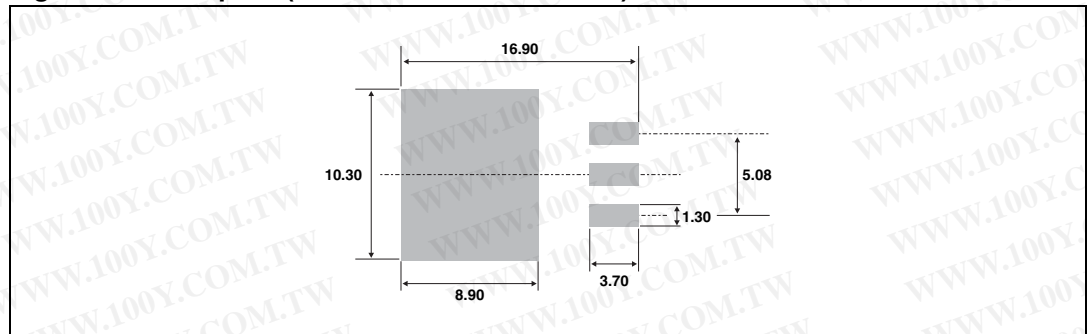

Devices in I²PAK with nickel-plated back frame must NOT be mounted by frame soldering like SMDs. Such devices are intended to be through-hole mounted ONLY and in no circumstances shall ST be held liable for any lack of performance or damage arising out of soldering of nickel-plated back frames.

Table 8. I²PAK dimensions

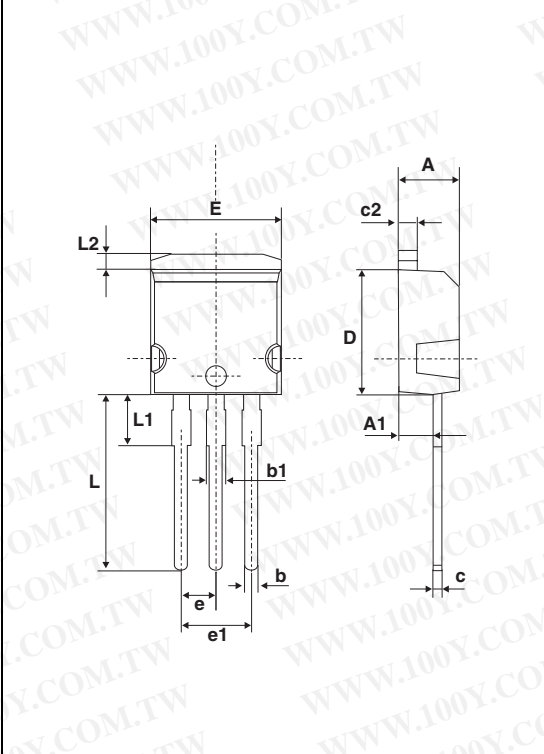

Ref.	Dimensions			
	Millimeters		Inches	
	Min.	Max.	Min.	Max.
A	4.40	4.60	0.173	0.181
A1	2.40	2.72	0.094	0.107
b	0.61	0.88	0.024	0.035
b1	1.14	1.70	0.044	0.067
c	0.49	0.70	0.019	0.028
c2	1.23	1.32	0.048	0.052
D	8.95	9.35	0.352	0.368
e	2.40	2.70	0.094	0.106
e1	4.95	5.15	0.195	0.203
E	10	10.40	0.394	0.409
L	13	14	0.512	0.551
L1	3.50	3.93	0.138	0.155
L2	1.27	1.40	0.050	0.055

Table 9. TO-247 dimensions

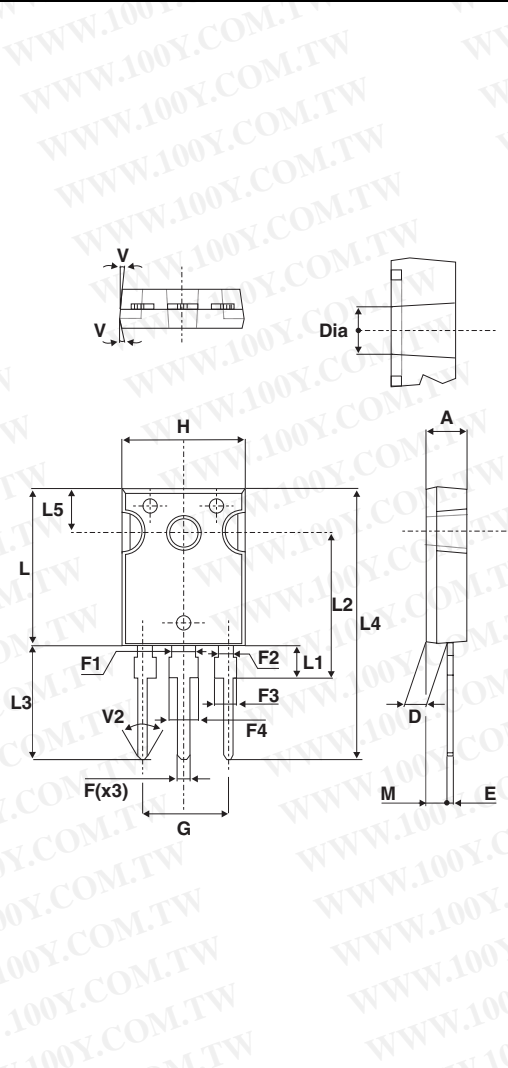

Ref.	Dimensions					
	Millimeters			Inches		
	Min.	Typ.	Max.	Min.	Typ.	Max.
A	4.85		5.15	0.191		0.203
D	2.20		2.60	0.086		0.102
E	0.40		0.80	0.015		0.031
F	1.00		1.40	0.039		0.055
F1		3.00			0.118	
F2		2.00			0.078	
F3	2.00		2.40	0.078		0.094
F4	3.00		3.40	0.118		0.133
G		10.90			0.429	
H	15.45		15.75	0.608		0.620
L	19.85		20.15	0.781		0.793
L1	3.70		4.30	0.145		0.169
L2		18.50			0.728	
L3	14.20		14.80	0.559		0.582
L4		34.60			1.362	
L5		5.50			0.216	
M	2.00		3.00	0.078		0.118
V		5°			5°	
V2		60°			60°	
Dia.	3.55		3.65	0.139		0.143

3 Ordering information

Table 10. Ordering information

Order code	Marking	Package	Weight	Base qty	Delivery mode
STPS30L60CW	STPS30L60CW	TO-247	4.4 g	30	Tube
STPS30L60CT	STPS30L60CT	TO-220AB	2.3 g	50	Tube
STPS30L60CG	STPS30L60CG	D ² PAK	1.5 g	50	Tube
STPS30L60CG-TR	STPS30L60CG	D ² PAK	1.5 g	1000	Tape and reel
STPS30L60CR	STPS30L60CR	I ² PAK	1.49 g	50	Tube
STPS30L60CFP	STPS30L60CFP	TO-220FPAB	2.0 g	50	Tube

4 Revision history

Table 11. Document revision history

Date	Revision	Description of changes
July-2003	3B	Initial release
16-Oct-2006	4	Reformatted to current standards. Corrected dimensions for I ² PAK in Table 5.
28-Nov-2006	5	Added TO-220FPAB package. Added STPS30L60CG-TR to ordering information.
07-Mar-2007	6	Updated thermal parameters in Table 2.
31-Mar-2007	7	Updated T _C = 110 °C in Table 1.
25-Aug-2008	8	Reformatted to current standards. Updated ECOPACK statement. Updated torque values and dimension illustration for TO-247 in Section 2 .
07-Feb-2011	9	Added electrical diagram on first page. Added parameters V _{ARM} and V _{ASM} to Table 2 . Added Figure 14 . Updated and added warning paragraph above Table 8 . Updated Table 10 .

Please Read Carefully:

Information in this document is provided solely in connection with ST products. STMicroelectronics NV and its subsidiaries ("ST") reserve the right to make changes, corrections, modifications or improvements, to this document, and the products and services described herein at any time, without notice.

All ST products are sold pursuant to ST's terms and conditions of sale.

Purchasers are solely responsible for the choice, selection and use of the ST products and services described herein, and ST assumes no liability whatsoever relating to the choice, selection or use of the ST products and services described herein.

No license, express or implied, by estoppel or otherwise, to any intellectual property rights is granted under this document. If any part of this document refers to any third party products or services it shall not be deemed a license grant by ST for the use of such third party products or services, or any intellectual property contained therein or considered as a warranty covering the use in any manner whatsoever of such third party products or services or any intellectual property contained therein.

UNLESS OTHERWISE SET FORTH IN ST'S TERMS AND CONDITIONS OF SALE ST DISCLAIMS ANY EXPRESS OR IMPLIED WARRANTY WITH RESPECT TO THE USE AND/OR SALE OF ST PRODUCTS INCLUDING WITHOUT LIMITATION IMPLIED WARRANTIES OF MERCHANTABILITY, FITNESS FOR A PARTICULAR PURPOSE (AND THEIR EQUIVALENTS UNDER THE LAWS OF ANY JURISDICTION), OR INFRINGEMENT OF ANY PATENT, COPYRIGHT OR OTHER INTELLECTUAL PROPERTY RIGHT.

UNLESS EXPRESSLY APPROVED IN WRITING BY AN AUTHORIZED ST REPRESENTATIVE, ST PRODUCTS ARE NOT RECOMMENDED, AUTHORIZED OR WARRANTED FOR USE IN MILITARY, AIR CRAFT, SPACE, LIFE SAVING, OR LIFE SUSTAINING APPLICATIONS, NOR IN PRODUCTS OR SYSTEMS WHERE FAILURE OR MALFUNCTION MAY RESULT IN PERSONAL INJURY, DEATH, OR SEVERE PROPERTY OR ENVIRONMENTAL DAMAGE. ST PRODUCTS WHICH ARE NOT SPECIFIED AS "AUTOMOTIVE GRADE" MAY ONLY BE USED IN AUTOMOTIVE APPLICATIONS AT USER'S OWN RISK.

Resale of ST products with provisions different from the statements and/or technical features set forth in this document shall immediately void any warranty granted by ST for the ST product or service described herein and shall not create or extend in any manner whatsoever, any liability of ST.

ST and the ST logo are trademarks or registered trademarks of ST in various countries.

Information in this document supersedes and replaces all information previously supplied.

The ST logo is a registered trademark of STMicroelectronics. All other names are the property of their respective owners.

© 2011 STMicroelectronics - All rights reserved

STMicroelectronics group of companies

Australia - Belgium - Brazil - Canada - China - Czech Republic - Finland - France - Germany - Hong Kong - India - Israel - Italy - Japan - Malaysia - Malta - Morocco - Philippines - Singapore - Spain - Sweden - Switzerland - United Kingdom - United States of America

www.st.com