



## T2035H Series

### Snubberless™ high temperature 20 A Triacs

#### Main features

Symbol	Value	Unit
$I_{T(RMS)}$	20	A
$V_{DRM}/V_{RRM}$	600	V
$I_{GT}(Q1)$	35	mA
$T_j MAX$	150	°C

#### Description

Specifically designed to operate at 150° C, the new 20 A T2035H Triacs provide an enhanced performance in terms of power loss and thermal dissipation. This facilitates the optimization of heatsink dimensioning, leading to improved space and cost effectiveness when compared to electro-mechanical solutions.

Based on ST Snubberless™ technology, the T2035H series offers high commutation switching capabilities and high noise immunity levels on the full range of  $T_j$ .

The T2035H series facilitates the optimization of the control of universal motors and inductive loads found in appliances such as vacuum cleaners, and washing machines.

The T2035H Triacs are also suitable for use in high temperature environment found in hot appliances such as cookers, ovens, hobs, electric heaters, and coffee machines.

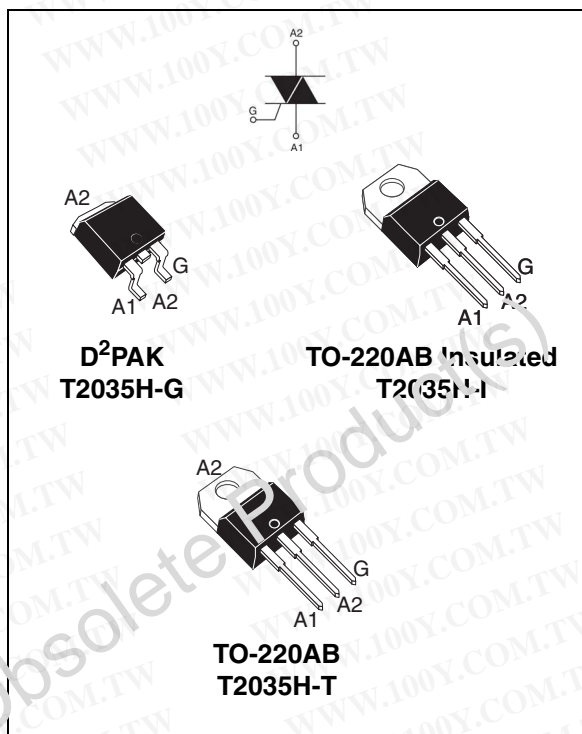

#### Order code

Part number	Marking
T2035H-600G	T2035H-600G
T2035H-600G-TR	T2035H-600G
T2035H-600TRG	T2035H-600T
T2035H-600IRG	T2035H-600I

TM: Snubberless is a trademark of STMicroelectronics

# 1 Characteristics

**Table 1. Absolute maximum ratings**

Symbol	Parameter		Value	Unit
$I_{T(RMS)}$	RMS on-state current (full sine wave)	D <sup>2</sup> PAK TO-220AB $T_c = 127^\circ\text{C}$	20	A
		TO-220AB Ins $T_c = 105^\circ\text{C}$		
$I_{TSM}$	Non repetitive surge peak on-state current (full cycle sine wave, $T_j$ initial = $25^\circ\text{C}$ )	F = 60 Hz $t = 16.7\text{ ms}$	210	A
		F = 50 Hz $t = 20\text{ ms}$	200	
$I^2t$	$I^2t$ Value for fusing	$t_p = 10\text{ ms}$	283	A <sup>2</sup> s
di/dt	Critical rate of rise of on-state current $I_G = 2xI_{GT}$ , $t_r \leq 100\text{ ns}$	F = 120 Hz $T_j = 125^\circ\text{C}$	50	A/ $\mu\text{s}$
$V_{DSM}/V_{RSM}$	Non repetitive surge peak off state voltage	$T_j = 25^\circ\text{C}$	700	V
$I_{GM}$	Peak gate current	$t_p = 20\text{ }\mu\text{s}$ $T_j = 150^\circ\text{C}$	4	A
$P_{G(AV)}$	Average gate power dissipation	$T_j = 150^\circ\text{C}$	1	W
$T_{stg}$ $T_j$	Storage junction temperature range Operating junction temperature range		-40 to +150 -30 to +150	$^\circ\text{C}$
$T_l$	Maximum leads soldering temperature during 10 s		260	$^\circ\text{C}$

**Table 2. Electrical characteristics ( $T_j = 25^\circ\text{C}$ , unless otherwise specified)**

Symbol	Test conditions	Quadrant	Value	Unit	
$I_{GT}^{(1)}$	$V_D = 12\text{ V}$ , $R_L = 33\text{ }\Omega$	I - II - III	MAX	35	mA
$V_{GT}$		I - II - III	MAX	1.3	V
$V_{GD}$	$V_D = V_{DRM}$ , $R_L = 3.3\text{ k}\Omega$ , $T_j = 150^\circ\text{C}$	I - II - III	MIN	0.15	V
$I_H^{(2)}$	$I_T = 100\text{ mA}$		MAX	35	mA
$I_L$	$I_G = 1.2 \times I_{GT}$	I - III	MAX	50	mA
		II		80	
dV/dt <sup>(2)</sup>	$V_D = 67\% V_{DRM}$ , gate open, $T_j = 150^\circ\text{C}$		MIN	300	V/ $\mu\text{s}$
(di/dt) <sub>C</sub> <sup>(2)</sup>	Without snubber, $T_j = 150^\circ\text{C}$		MIN	8.9	A/ms

1. minimum  $I_{GT}$  is guaranteed at 5% of  $I_{GT}$  max
2. for both polarities of A2 referenced to A1

**Table 3. Static electrical characteristics**

Symbol	Test conditions			Value	Unit
$V_{TM}^{(1)}$	$I_{TM} = 28\text{ A}$ , $t_p = 380\ \mu\text{s}$	$T_j = 25^\circ\text{ C}$	MAX	1.5	V
$V_{TO}^{(1)}$		$T_j = 150^\circ\text{ C}$	MAX	0.80	V
$R_D^{(1)}$		$T_j = 150^\circ\text{ C}$	MAX	21	m $\Omega$
$I_{DRM}$ $I_{RRM}$	$V_{DRM} = V_{RRM}$	$T_j = 25^\circ\text{ C}$	MAX	5	$\mu\text{A}$
		$T_j = 150^\circ\text{ C}$		7.4	mA
	$V_D/V_R = 400\text{ V}$ (at peak mains voltage)	$T_j = 150^\circ\text{ C}$		4.8	

1. for both polarities of A2 referenced to A1

**Table 4. Thermal resistance**

Symbol	Parameter		Value	Unit
$R_{th(j-c)}$	Junction to case for full (AC)	D <sup>2</sup> PAK TO-220AB	1	°C/W
		TO-220AB Ins	1.9	
$R_{th(j-a)}$	Junction to ambient	S = 1 cm <sup>2</sup> D <sup>2</sup> PAK	45	
		TO-220AB TO-220AB Ins	60	

**Figure 1. Maximum power dissipation vs RMS on-state current (full cycle)**

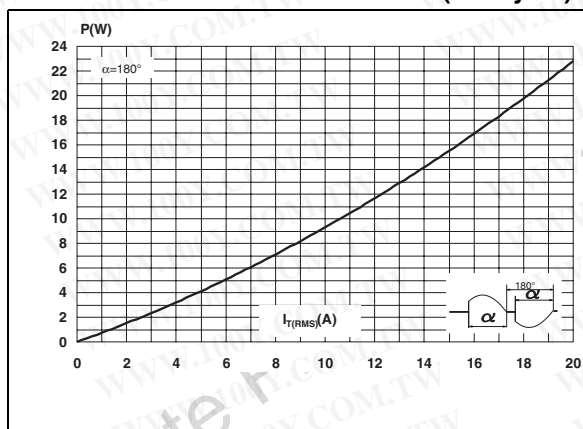

**Figure 2. RMS on-state current versus case temperature**

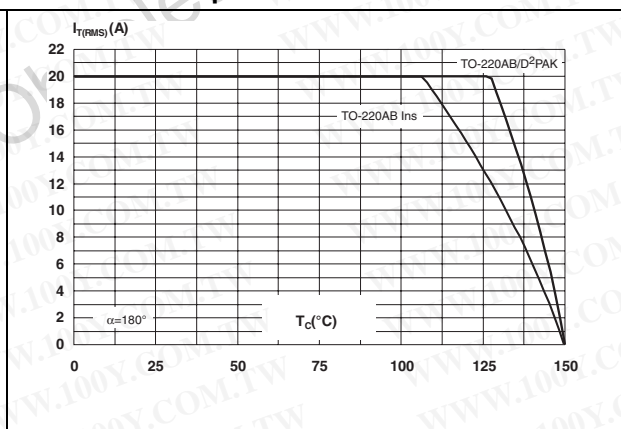

Figure 3. RMS on-state current vs ambient temperature (epoxy printed circuit board FR4  $\epsilon_{cu} = 35 \mu m$ )

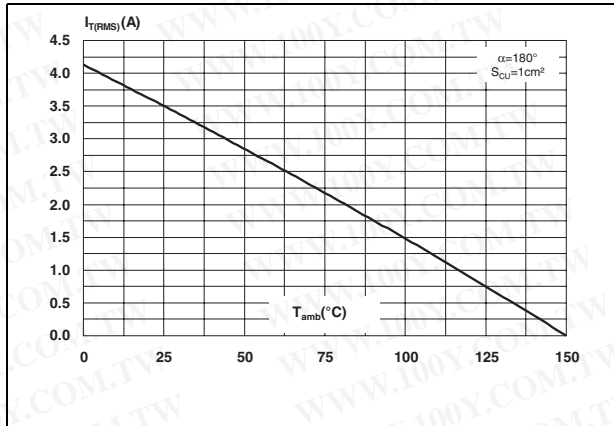

Figure 4. Relative variation of thermal impedance vs pulse duration

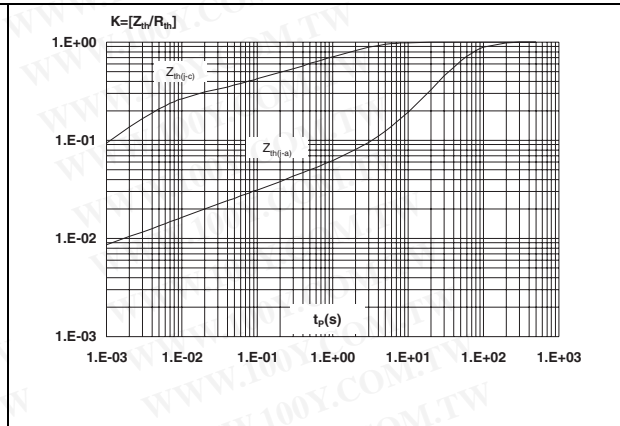

Figure 5. On-state characteristics (maximum values)

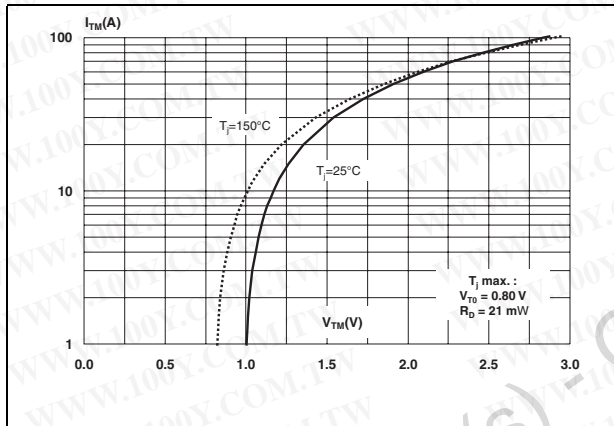

Figure 6. Surge peak on-state current vs number of cycles

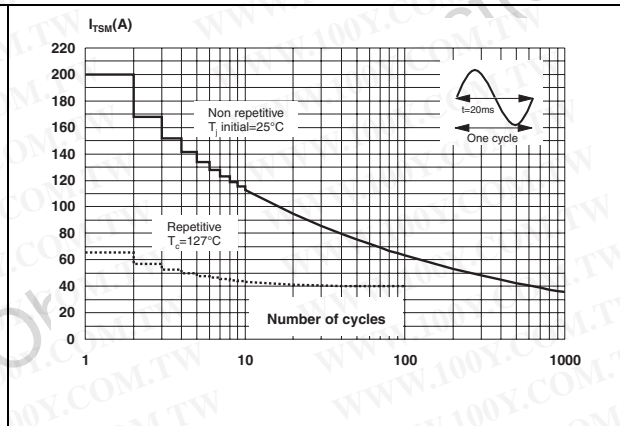

Figure 7. Non repetitive surge peak on-state current (sinusoidal pulse width  $t_p < 10 ms$ ) and value of  $I^2t$

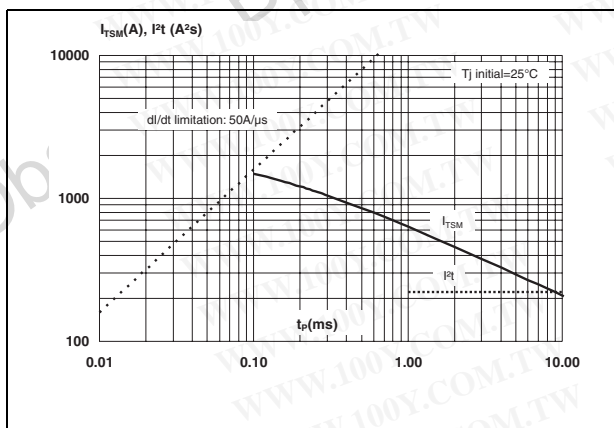

Figure 8. Relative variation of gate trigger current, holding current and latching current vs junction temperature (typical values)

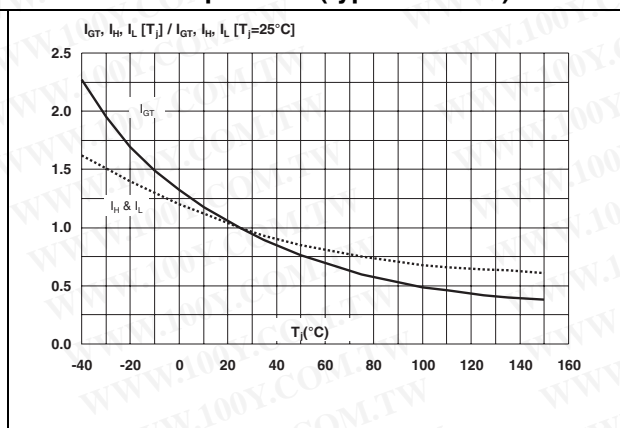

Figure 9. Relative variation of critical rate of decrease of main current  $(di/dt)_c$  versus reapplied  $(dV/dt)_c$

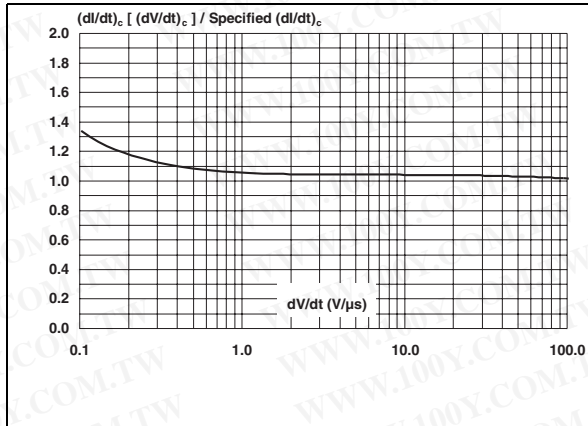

Figure 10. Relative variation of critical rate of decrease of main current  $(di/dt)_c$  versus junction temperature

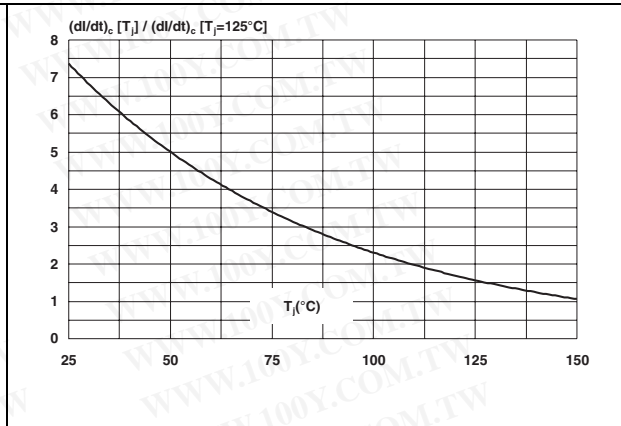

Figure 11. Leakage current versus junction temperature for different values of blocking voltage (typical values)

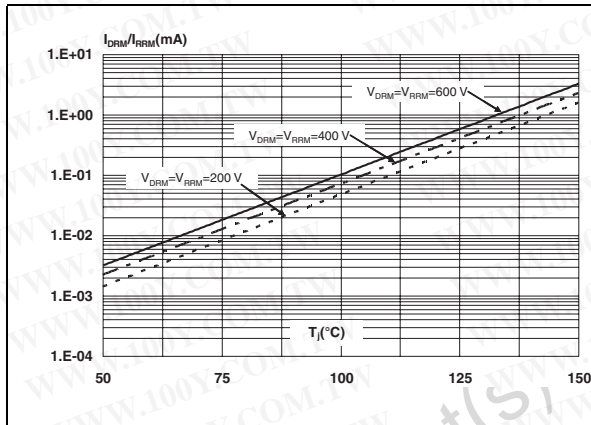

Figure 12. Acceptable repetitive peak off-state voltage versus case-ambient thermal resistance

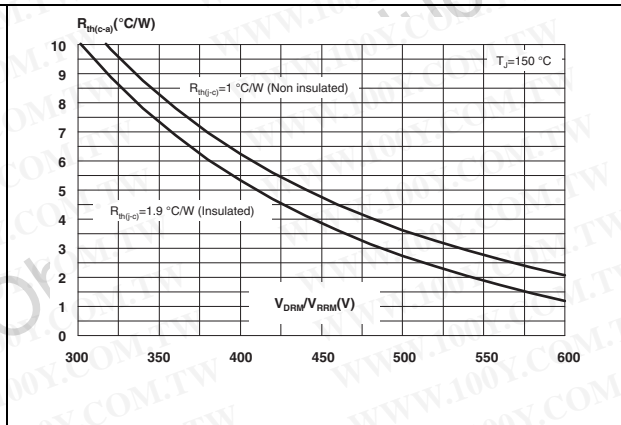
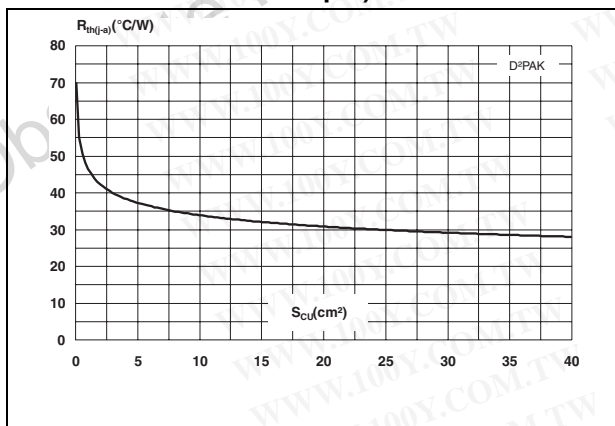
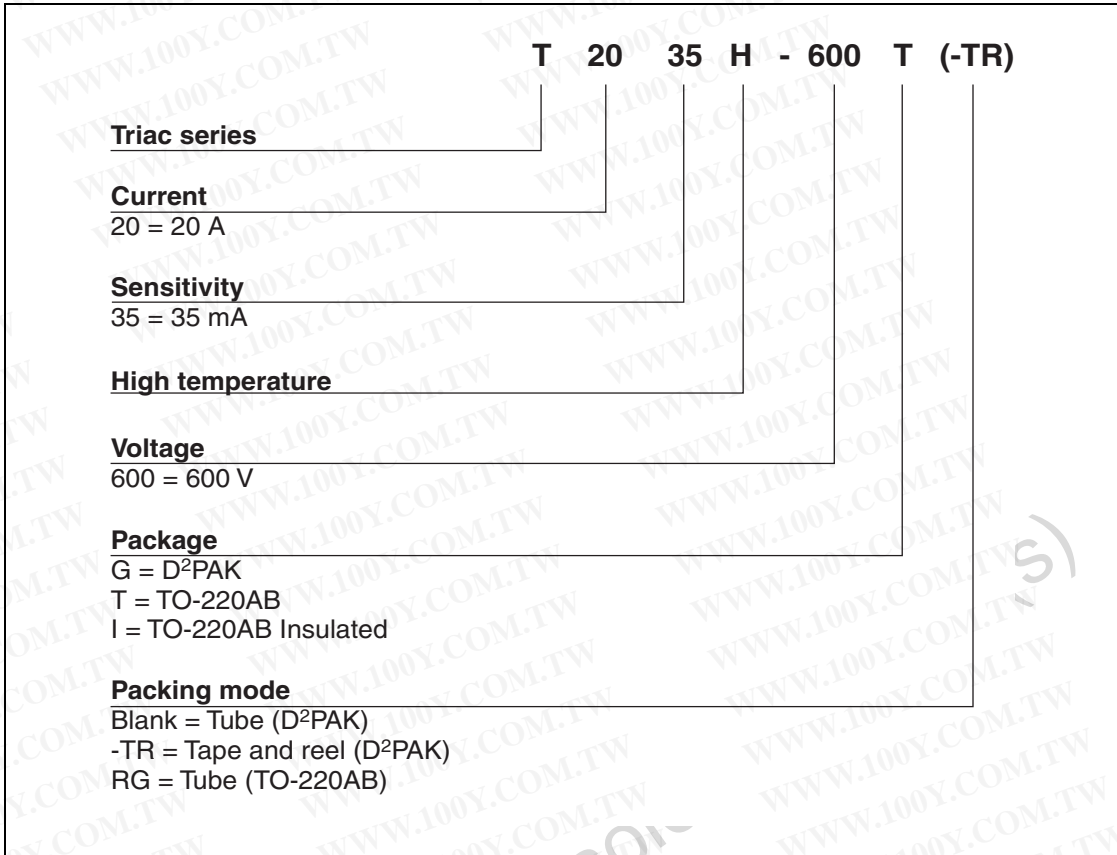

Figure 13. D<sup>2</sup>PAK junction to ambient thermal resistance versus copper surface under tab (PCB FR4, copper thickness 35  $\mu m$ )



## 2 Ordering information scheme



Obsolete Product(s) - Obsolete

### 3 Package information

Table 5. TO-220AB and TO-220AB Insulated dimensions

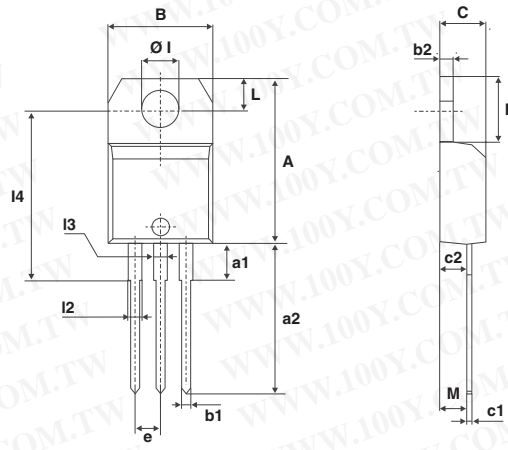

REF.	DIMENSIONS					
	Millimeters			Inches		
	Min.	Typ.	Max.	Min.	Typ.	Max.
A	15.20		15.90	0.598		0.625
a1		3.75			0.147	
a2	13.00		14.00	0.511		0.551
B	10.00		10.40	0.393		0.409
b1	0.61		0.88	0.024		0.034
b2	1.23		1.32	0.048		0.051
C	4.40		4.60	0.173		0.181
c1	0.49		0.70	0.019		0.027
c2	2.40		2.72	0.094		0.107
e	2.40		2.70	0.094		0.106
F	6.20		6.60	0.244		0.259
Ø1	3.75		3.85	0.147		0.151
l4	15.80	16.40	16.80	0.622	0.646	0.661
L	2.65		2.95	0.104		0.116
l2	1.14		1.70	0.044		0.066
l3	1.14		1.70	0.044		0.066
M		2.60			0.102	

Table 6. D<sup>2</sup>PAK dimensions

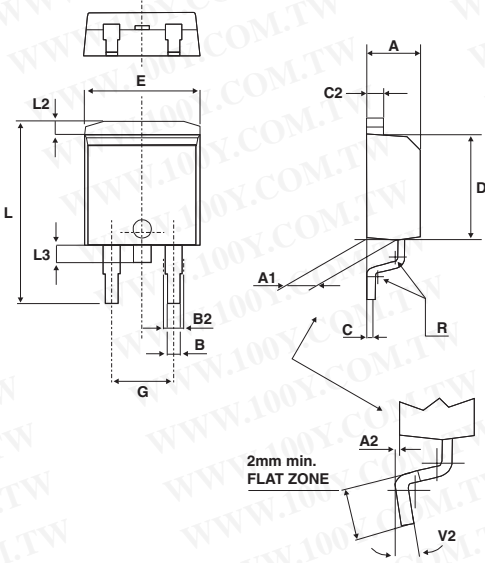

REF.	DIMENSIONS			
	Millimeters		Inches	
	Min.	Max.	Min.	Max.
A	4.40	4.60	0.173	0.181
A1	2.49	2.69	0.098	0.106
A2	0.03	0.23	0.001	0.009
B	0.70	0.93	0.027	0.037
B2	1.14	1.70	0.045	0.067
C	0.45	0.60	0.017	0.024
C2	1.23	1.36	0.048	0.054
D	8.95	9.35	0.352	0.368
E	10.00	10.40	0.393	0.409
G	4.88	5.28	0.192	0.208
L	15.00	15.85	0.590	0.624
L2	1.27	1.40	0.050	0.055
L3	1.40	1.75	0.055	0.069
M	2.40	3.20	0.094	0.126
R	0.40 typ.		0.016 typ.	
V2	0°	8°	0°	8°

Figure 14. D<sup>2</sup>PAK Footprint

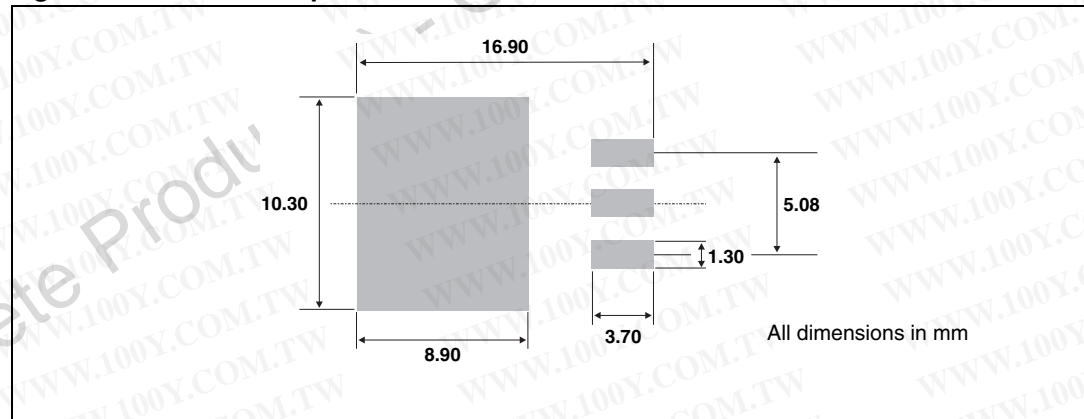

In order to meet environmental requirements, ST offers these devices in ECOPACK® packages. These packages have a Lead-free second level interconnect. The category of second level interconnect is marked on the package and on the inner box label, in compliance with JEDEC Standard JESD97. The maximum ratings related to soldering conditions are also marked on the inner box label. ECOPACK is an ST trademark. ECOPACK specifications are available at: [www.st.com](http://www.st.com).



## 4 Ordering information

Part number	Marking	Package	Weight	Base Qty	Packing mode
T2035H-600G	T2035H-600G	D <sup>2</sup> PAK	1.5 g	50	Tube
T2035H-600G-TR	T2035H-600G	D <sup>2</sup> PAK	1.5 g	1000	Tape and Reel
T2035H-600TRG	T2035H-600T	TO-220AB	2.3 g	50	Tube
T2035H-600IRG	T2035H-600I	TO-220ABIns	2.3 g	50	Tube

## 5 Revision history

Date	Revision	Changes
13-Jul-2006	1	Initial release.
7-Sep-2006	2	Added TO-220AB Insulated package.

**Please Read Carefully:**

Information in this document is provided solely in connection with ST products. STMicroelectronics NV and its subsidiaries ("ST") reserve the right to make changes, corrections, modifications or improvements, to this document, and the products and services described herein at any time, without notice.

All ST products are sold pursuant to ST's terms and conditions of sale.

Purchasers are solely responsible for the choice, selection and use of the ST products and services described herein, and ST assumes no liability whatsoever relating to the choice, selection or use of the ST products and services described herein.

No license, express or implied, by estoppel or otherwise, to any intellectual property rights is granted under this document. If any part of this document refers to any third party products or services it shall not be deemed a license grant by ST for the use of such third party products or services, or any intellectual property contained therein or considered as a warranty covering the use in any manner whatsoever of such third party products or services or any intellectual property contained therein.

**UNLESS OTHERWISE SET FORTH IN ST'S TERMS AND CONDITIONS OF SALE ST DISCLAIMS ANY EXPRESS OR IMPLIED WARRANTY WITH RESPECT TO THE USE AND/OR SALE OF ST PRODUCTS INCLUDING WITHOUT LIMITATION IMPLIED WARRANTIES OF MERCHANTABILITY, FITNESS FOR A PARTICULAR PURPOSE (AND THEIR EQUIVALENTS UNDER THE LAWS OF ANY JURISDICTION), OR INFRINGEMENT OF ANY PATENT, COPYRIGHT OR OTHER INTELLECTUAL PROPERTY RIGHT.**

**UNLESS EXPRESSLY APPROVED IN WRITING BY AN AUTHORIZED ST REPRESENTATIVE, ST PRODUCTS ARE NOT RECOMMENDED, AUTHORIZED OR WARRANTED FOR USE IN MILITARY, AIR CRAFT, SPACE, LIFE SAVING, OR LIFE SUSTAINING APPLICATIONS, NOR IN PRODUCTS OR SYSTEMS WHERE FAILURE OR MALFUNCTION MAY RESULT IN PERSONAL INJURY, DEATH, OR SEVERE PROPERTY OR ENVIRONMENTAL DAMAGE. ST PRODUCTS WHICH ARE NOT SPECIFIED AS "AUTOMOTIVE GRADE" MAY ONLY BE USED IN AUTOMOTIVE APPLICATIONS AT USER'S OWN RISK.**

Resale of ST products with provisions different from the statements and/or technical features set forth in this document shall immediately void any warranty granted by ST for the ST product or service described herein and shall not create or extend in any manner whatsoever, any liability of ST.

ST and the ST logo are trademarks or registered trademarks of ST in various countries.

Information in this document supersedes and replaces all information previously supplied.

The ST logo is a registered trademark of STMicroelectronics. All other names are the property of their respective owners.

© 2006 STMicroelectronics - All rights reserved

STMicroelectronics group of companies

Australia - Belgium - Brazil - Canada - China - Czech Republic - Finland - France - Germany - Hong Kong - India - Israel - Italy - Japan - Malaysia - Malta - Morocco - Singapore - Spain - Sweden - Switzerland - United Kingdom - United States of America

[www.st.com](http://www.st.com)