

SANKEN DISCRETES

TRANSISTOR ARRAYS

Type No.	V _{CEO} (V)	I _{C(ICP)} (A)	h _{FE} min	Equivalent Circuit Diagram
STA301A	60±10	4(8)	1000	1
STA302A	-50	-4(-8)	1000	2
STA303A	100	4(8)	1000	3
STA304A	550	1(2)	200	4
STA305A	-550	-1(-2)	200	5
STA308A	-120	-4(-8)	2000	6
STA311A	50	3(5)	70	7
STA312A	60	3(6)	300	7
STA321A	-60	-3(-6)	40	8
STA322A	-50	-3(-5)	100	8
STA341M	30	1	100	9
	-30	-1	100	
STA342M	30	1	100	10
STA401A	60±10	4(8)	1000	11
STA402A	-50	-4(-8)	1000	12
STA403A	100	4(8)	1000	13
STA404A	200	3(6)	1000	13
STA405A	80	4(8)	1000	13
STA406A	60±10	6	2000	11
STA407A	100±15	4(8)	2000	11
STA408A	-120	-4(-8)	2000	14
STA411A	60	3(6)	40	15
STA412A	60	3(6)	300	15
STA413A	35±5	3(6)	500	16
STA414A	(V _{CER})100	5(8)	200	17
STA421A	-60	-3(-6)	40	18
STA431A	60	3(6)	40	19
	-60	-3(-6)	40	
STA432A	60±10	4(8)	1000	20
	-60	-3(-6)	40	
STA433A	100	4(8)	1000	21
STA434A	60	4(8)	1000	22
	-60	-4(-8)	1000	
STA435A	65±15	4(8)	1000	23
STA437A	-50	-4(-8)	1000	14
STA438A	200	3(6)	1000	21
STA439A	60±10	6	2000	23
STA441C	160	1.5(3)	40	24
STA451C	60	3(6)	40	25
	-60	-3(-6)	40	
STA455C	35	7(12)	80	26
	-35	-7(-12)	80	
STA457C	60	4(8)	2000	27
	-60	-4(-8)	2000	
STA458C	30	5(10)	40	28
	-30	-5(-10)	40	
STA460C	60±10	±6(±10)	700	29
STA471A	60±10	2(4)	2000	11
STA472A	-60	-2(-4)	2000	12
STA473A	100	2(4)	2000	13
STA475A	100±15	2(4)	2000	11

Type No.	V _{CEO} (V)	I _{C(ICP)} (A)	h _{FE} min	Equivalent Circuit Diagram
SMA4020	-60	-4	2000	30
SMA4021	-60	-3(-6)	2000	31
SMA4030	100	3(5)	2000	32
SMA4031	100	3(5)	2000	33
SMA4032	100	3(5)	2000	33
SMA4033	100	2(4)	2000	33
SMA4121	50	3	500	34
SMA6010	60	4(6)	2000	35
	-60	-4(-6)	2000	
SMA6012	60	4(6)	2000	36
	-60	-4(-6)	2000	
SMA6040	30	2(4)	2000	37
	-30	-2(-4)	70	
SMA6511	100±15	1.5	2000	38
	-50	-3	2000	
SMA6512	60±10	1.5	2000	38
	-50	-3	2000	

勝特力材料 886-3-5753170

勝特力电子(上海) 86-21-34970699

勝特力电子(深圳) 86-755-83298787

[Http://www.100y.com.tw](http://www.100y.com.tw)

SANKEN DISCRETES TRANSISTOR ARRAYS

TRANSISTOR ARRAYS

Type No.	V_{CE0} (V)	$I_c(I_{CP})$ (A)	h_{FE} min	Equivalent Circuit Diagram
SLA4010	60±10	4(6)	2000	39
SLA4020	-60	-4(-6)	2000	40
SLA4030	100	4(6)	2000	41
SLA4031	120	4(6)	2000	42
SLA4041	200	3(6)	1000	42
SLA4060	120	5(8)	2000	41
SLA4061	120	5(8)	2000	42
SLA4070	-100	-5(-8)	1000	40
SLA4071	-100	-5(-8)	1000	43
SLA4310	60	4(6)	80	44
SLA4310	-60	-4(-6)	80	44
SLA4312	60	4(6)	40	45
SLA4312	-60	-4(-6)	40	45
SLA4313	35	5(8)	50	46
SLA4313	-35	-5(-8)	50	46
SLA4340	60	4(6)	2000	47
SLA4340	-60	-4(-6)	2000	47
SLA4342	60	4(6)	2000	48
SLA4342	-60	-4(-6)	2000	48
SLA4390	100	5(8)	2000	47
SLA4390	-100	-5(-8)	2000	47
SLA4391	100	5(8)	1000	49
SLA4391	-100	-5(-8)	1000	49
SLA4392	100	5(8)	1000	50
SLA4392	-100	-5(-8)	1000	50
SLA6010	60	4(6)	2000	51
SLA6010	-60	-4(-6)	2000	51
SLA6012	60	4	2000	52
SLA6012	-60	-4	2000	52
SLA6020	100	5(8)	2000	51
SLA6020	-100	-5(-8)	2000	51
SLA6022	80	5(8)	2000	52
SLA6022	-100	-5(-8)	2000	52
SLA6023	60	6(12)	2000	52
SLA6023	-60	-6(-12)	2000	52
SLA6030	35	4(6)	70	53
SLA6030	-35	-4(-6)	70	53
SLA6050	100	5	2000	51
SLA6050	-60	-4	2000	51
SLA8001	60	12	50	54
SLA8001	-60	-12	50	54
SLA1008	120 (V_R)	(I_0) 0.7		55

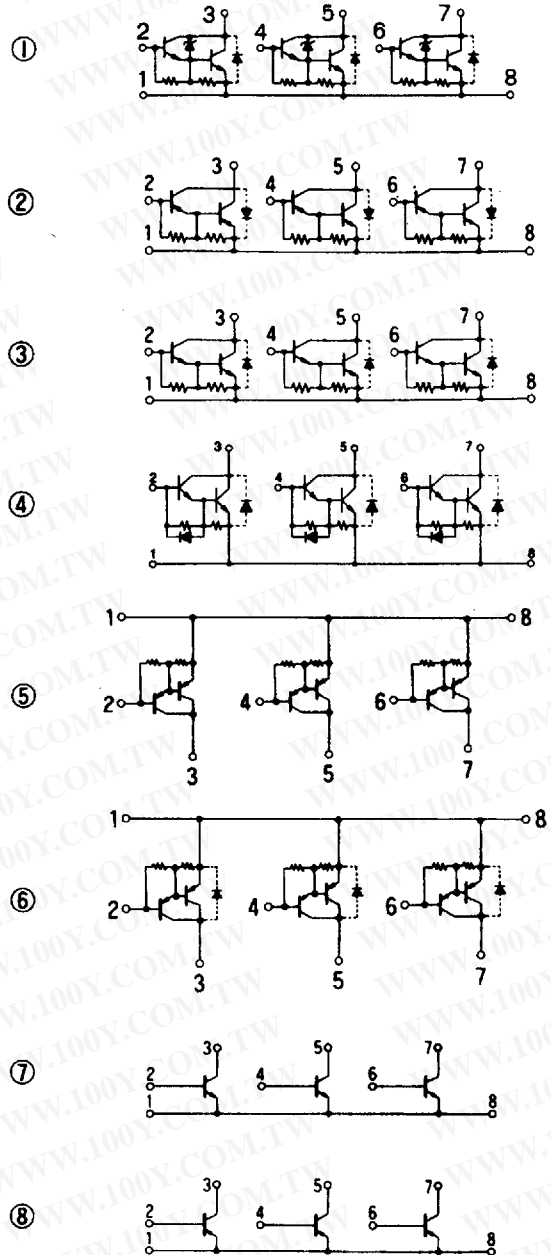

勝特力材料 886-3-5753170
 勝特力电子(上海) 86-21-34970699
 勝特力电子(深圳) 86-755-83298787
[Http://www.100y.com.tw](http://www.100y.com.tw)

SANKEN DISCRETES TRANSISTOR ARRAYS

勝特力材料 886-3-5753170
 勝特力电子(上海) 86-21-34970699
 勝特力电子(深圳) 86-755-83298787
[Http://www.100y.com.tw](http://www.100y.com.tw)

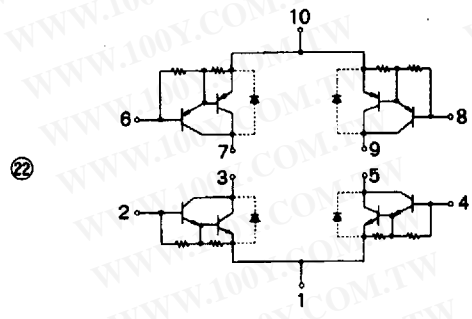
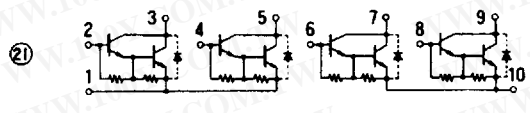
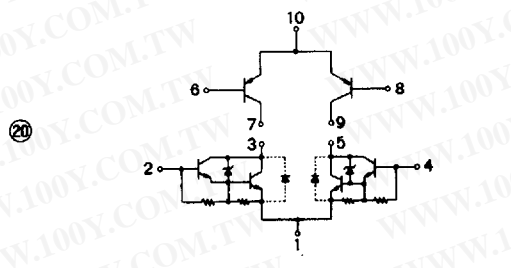
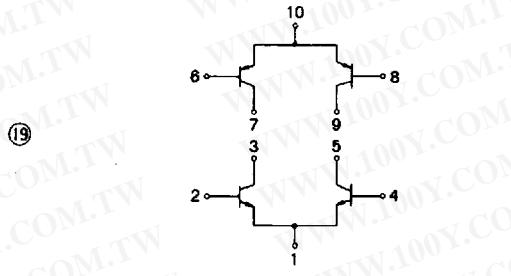
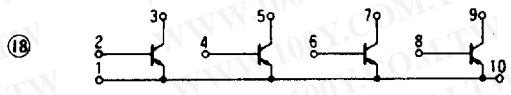
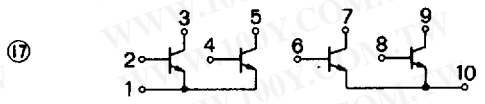
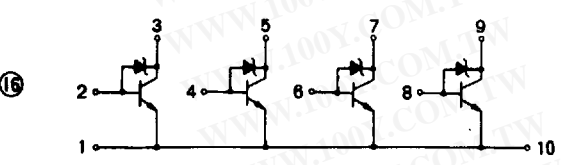
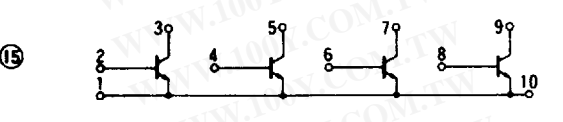
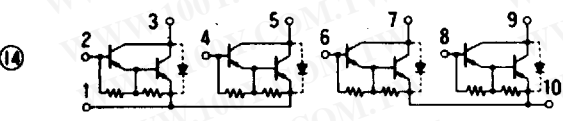
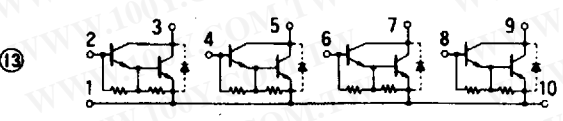
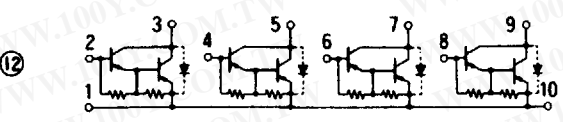
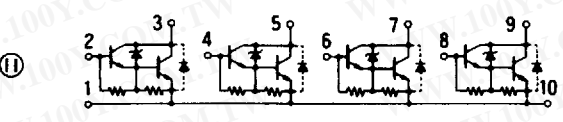
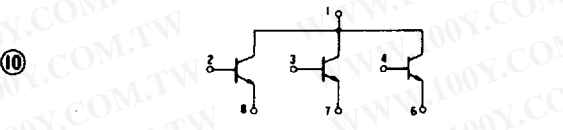
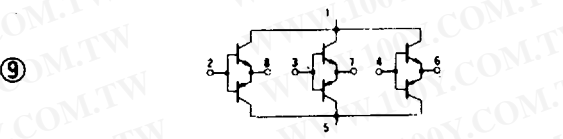

SANKEN DISCRETES TRANSISTOR ARRAYS

勝特力材料 886-3-5753170
 勝特力电子(上海) 86-21-34970699
 勝特力电子(深圳) 86-755-83298787
[Http://www.100y.com.tw](http://www.100y.com.tw)

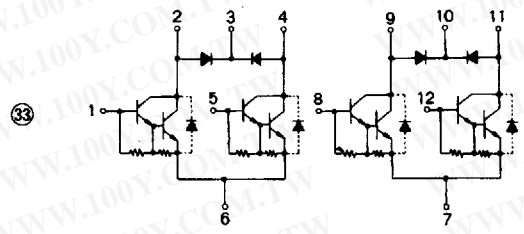
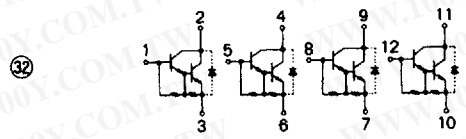
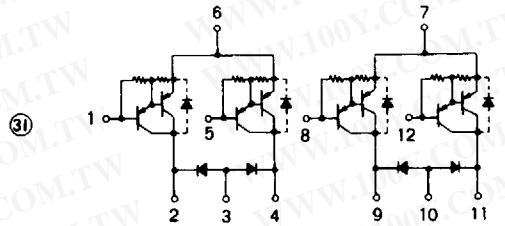
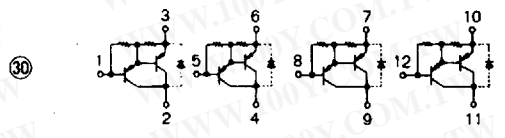
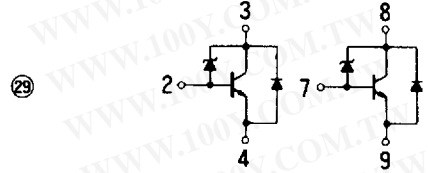
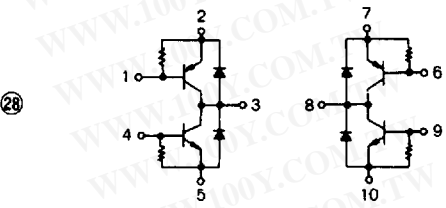
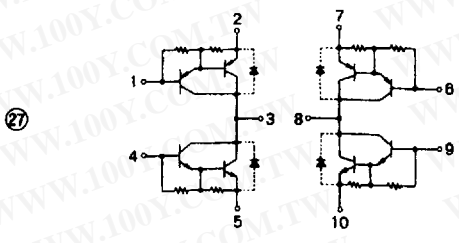
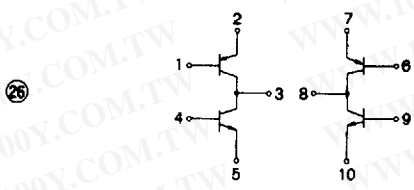
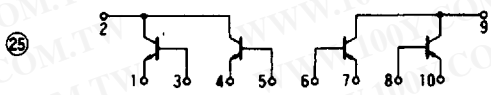
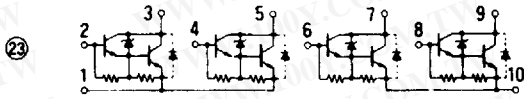

SANKEN DISCRETES TRANSISTOR ARRAYS

勝特力材料 886-3-5753170
 勝特力电子(上海) 86-21-34970699
 勝特力电子(深圳) 86-755-83298787
[Http://www.100y.com.tw](http://www.100y.com.tw)

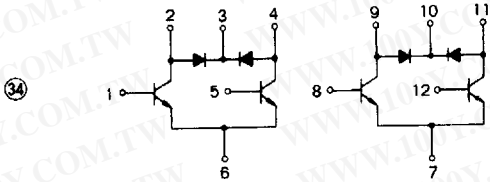

註

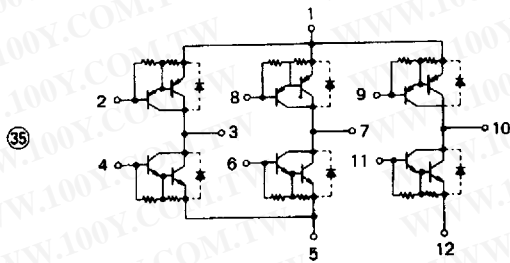

③⑥

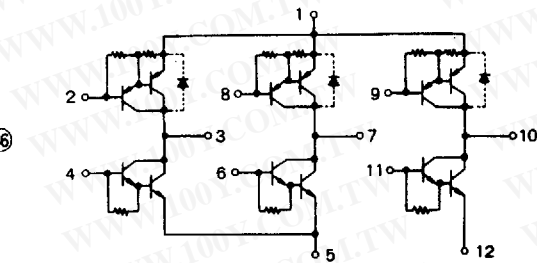
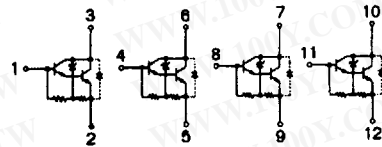

④①



④②

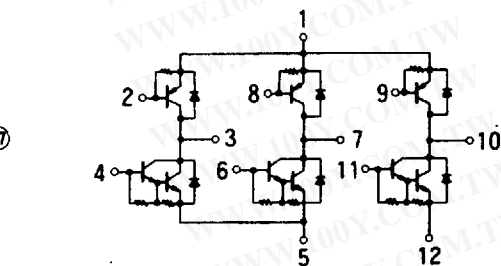
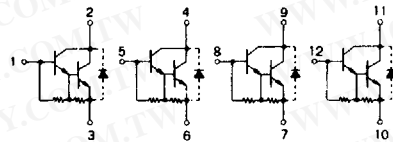

④④

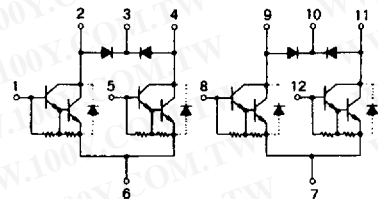

SANKEN DISCRETES TRANSISTOR ARRAYS

勝特力材料 886-3-5753170
 勝特力电子(上海) 86-21-34970699
 勝特力电子(深圳) 86-755-83298787
[Http://www.100y.com.tw](http://www.100y.com.tw)

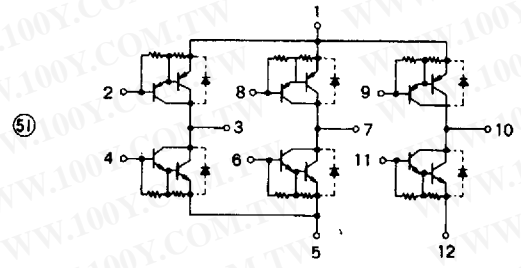
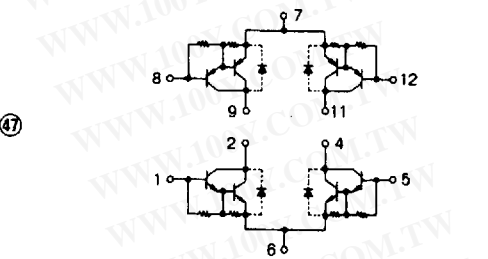
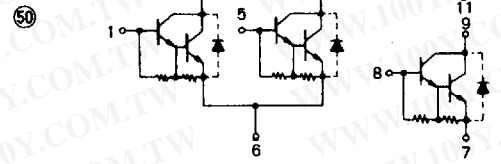
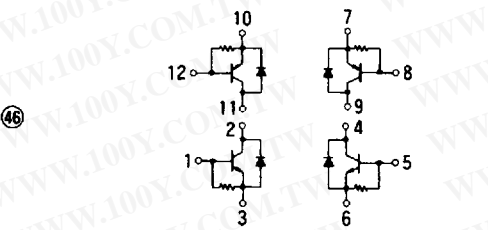
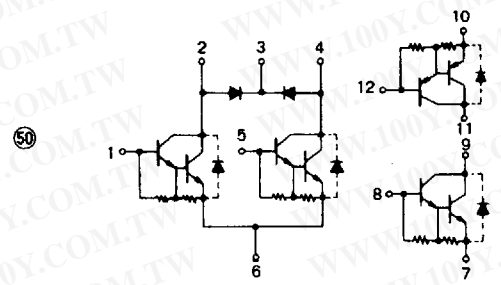
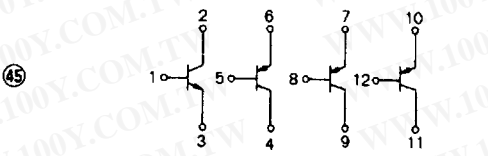
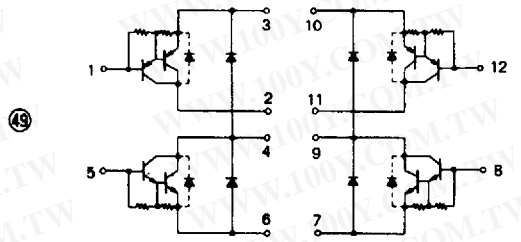
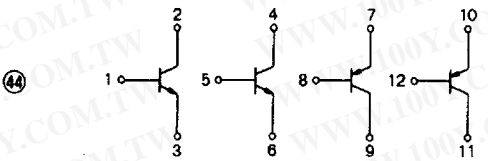
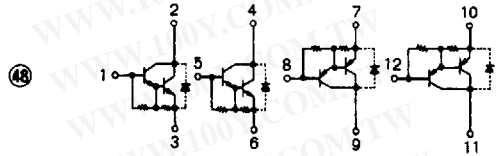
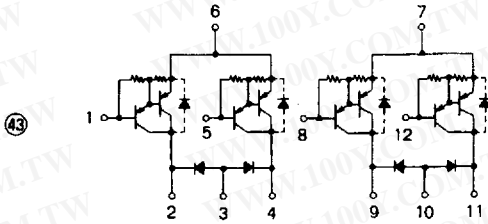

SANKEN DISCRETES TRANSISTOR ARRAYS

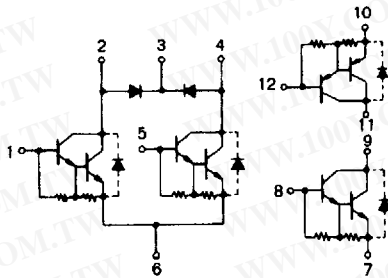

53

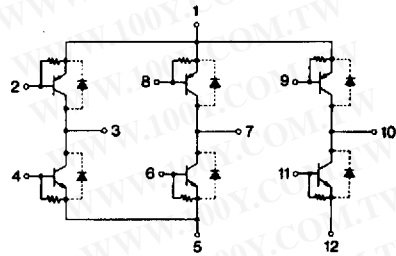

51

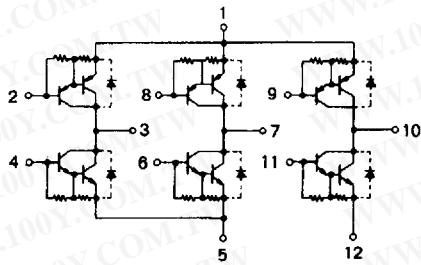

54

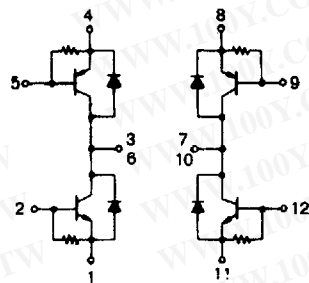

52

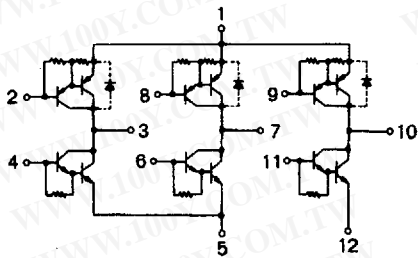

55

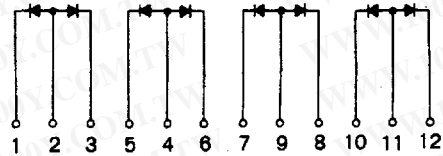

勝特力材料 886-3-5753170
 勝特力电子(上海) 86-21-34970699
 勝特力电子(深圳) 86-755-83298787
[Http://www.100y.com.tw](http://www.100y.com.tw)