

勝特力電材超市-龍山店 886-3-5773766
 勝特力電材超市-光復店 886-3-5729570
 勝特力電子(上海) 86-21-34970699
 勝特力電子(深圳) 86-755-83298787
<http://www.100y.com.tw>

**TVS
 1.5KE
 SERIES**

**GPP TRANSIENT VOLTAGE SUPPRESSOR
 1500 WATT PEAK POWER 6.5 WATTS STEADY STATE**

FEATURES

- * Plastic package has underwriters laboratory
- * Glass passivated chip construction
- * 1500 watt surge capability at 1ms
- * Excellent clamping capability
- * Low zener impedance
- * Fast response time

MECHANICAL DATA

- * Epoxy: Device has UL flammability classification 94V-O
- * UL file No.:E211196

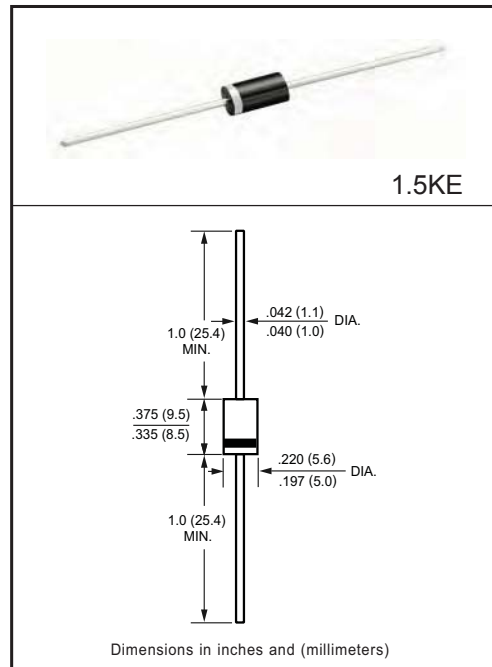

MAXIMUM RATINGS AND ELECTRICAL CHARACTERISTICS

Ratings at 25 °C ambient temperature unless otherwise specified.

Single phase, half wave, 60 Hz, resistive or inductive load,
 For capacitive load, derate current by 20%.

MAXIMUM RATINGS (@ TA=25 °C unless otherwise noted)

RATINGS	SYMBOL	VALUE	UNITS
Peak Power Dissipation at TA = 25°C, TP = 1mS (Note 1)	PPPM	Minimum 1500	W
Steady State Power Dissipation at TL = 75°C lead length, .375" (9.5 mm) (Note 2)	PM(AV)	6.5	W
Peak Forward Surge Current, 8.3mS Single half sine-wave superimposed on rated load (JEDEC METHODE)	IFSM	200	A
Typical Current Squared Time	I ² T	166	A ² S
Maximum instantaneous forwards voltage at 50A for unidirectional only (Note 4)	VF	3.5/5.0	V
Operating and Storage Temperature Range	TJ, TSTG	-55 to + 150	°C

- NOTES : 1. Non-repetitive current pulse, per Fig.3 and derated above TA = 25°C per Fig.2.
 2. Mounted on 0.2 X 0.2" (5.0 X 5.0mm) copper pad to each terminal.
 3. "ROHS compliant"
 4. VF =3.5V max. for devices of V(BR) ≤220V and VF =5.0Volts for device of V(BR) ≥220V.

2023-02
 REV:D

RATING AND CHARACTERISTICS CURVES (1.5KE6.8 THRU 1.5KE600CA)

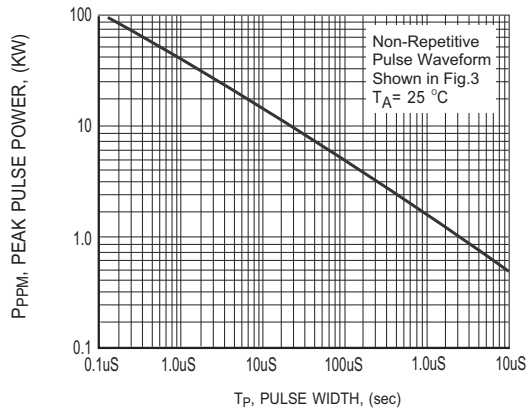

FIG.1 PEAK PULSE POWER RATING CURVE

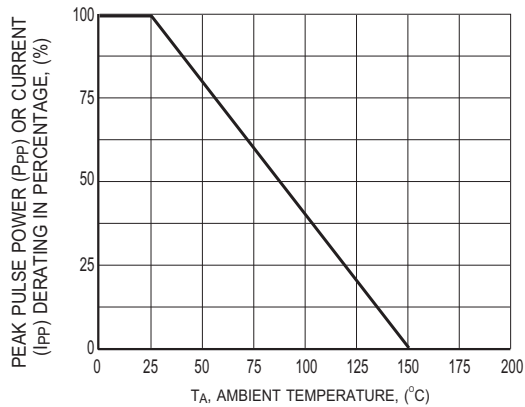

FIG.2 PULSE DERATING CURVE

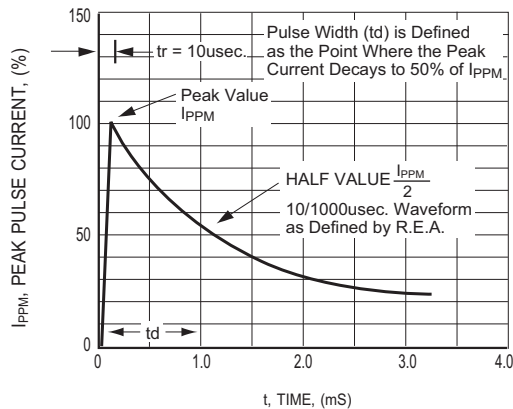

FIG.3 PULSE WAVEFORM

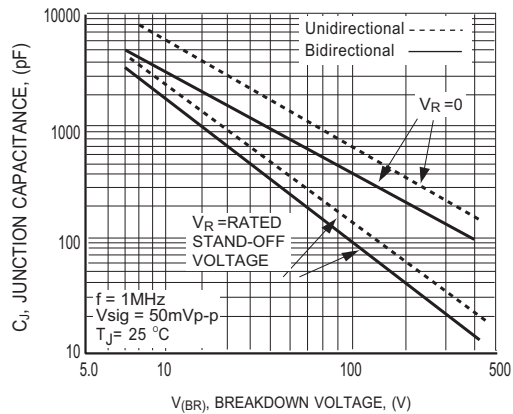

FIG.4 TYPICAL JUNCTION CAPACITANCE BIDIRECTIONAL

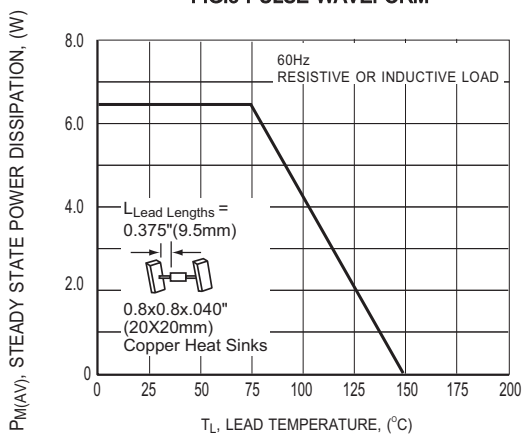

FIG.5 STEADY STATE POWER DERATING CURVE

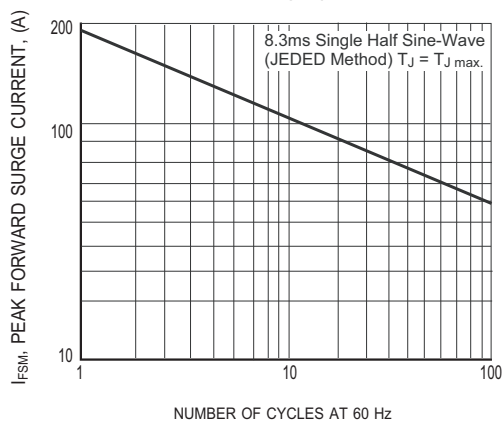

FIG.6 MAXIMUM NON-REPETITIVE FORWARD SURGE CURRENT UNIDIRECTIONAL

RATING AND CHARACTERISTICS CURVES (1.5KE6.8 THRU 1.5KE600CA)

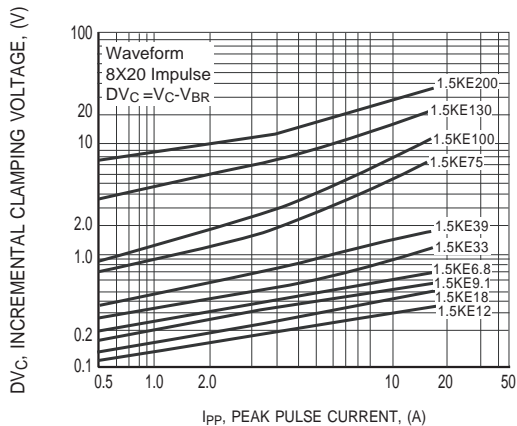

FIG.7 INCREMENTAL CLAMPING VOLTAGE CURVE UNIDIRECTIONAL

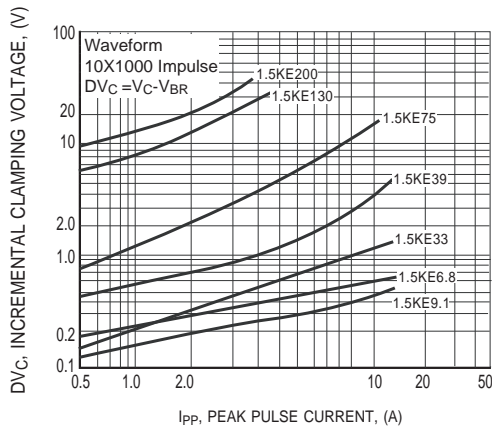

FIG.8 INCREMENTAL CLAMPING VOLTAGE CURVE UNIDIRECTIONAL

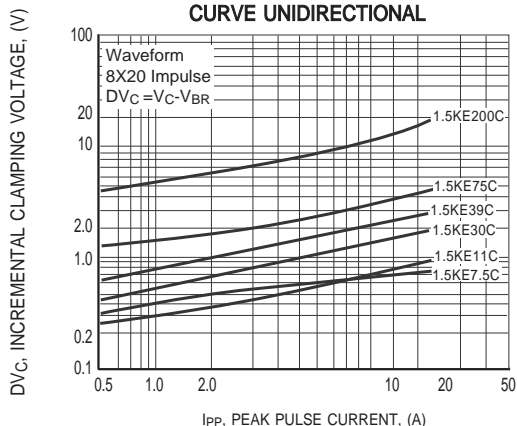

FIG.9 INCREMENTAL CLAMPING VOLTAGE CURVE UNIDIRECTIONAL

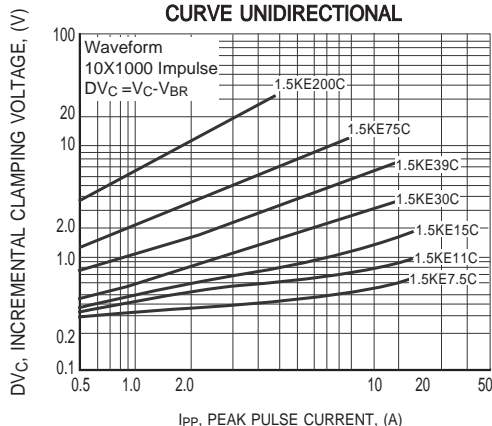

FIG.10 INCREMENTAL CLAMPING VOLTAGE CURVE UNIDIRECTIONAL

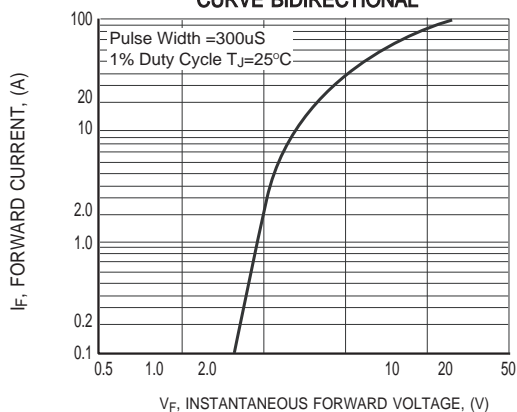

FIG.11 INSTANTANEOUS FORWARD VOLTAGE CHARACTERISTICS CURVE

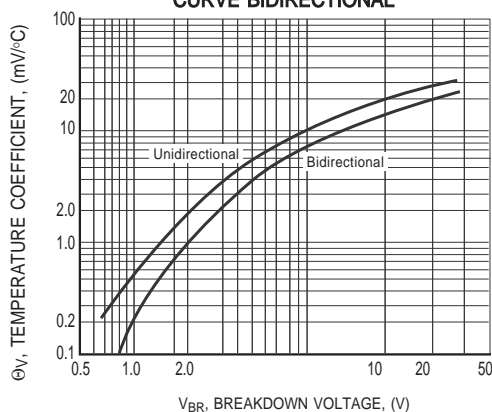

FIG.12 BREAKDOWN VOLTAGE TEMPERATURE COEFFICIENT CURVE

TRANSIENT VOLTAGE SUPPRESSORS

1500W SERIES TVS DIODES/ 1.5KE (CASE 10) 1500W

TYPE	Breakdown Voltage			Reverse Stand off Voltage V_{WM} (Volts)	Maximum Reverse Leakage at V_{WM} I_D (μ A)	Maximum Peak Pulse Current I_{PPM} (Amps)	Maximum Clamping Voltage at I_{PPM} V_C (Volts)
	VBR (Volts)		@IT (mA)				
	MIN.	MAX.					
1.5KE6.8	6.12	7.48	10	5.50	1000	139	10.8
1.5KE6.8A	6.45	7.14	10	5.80	1000	143	10.5
1.5KE7.5	6.75	8.25	10	6.05	500	128	11.7
1.5KE7.5A	7.13	7.88	10	6.40	500	133	11.3
1.5KE8.2	7.38	9.02	10	6.63	200	120	12.5
1.5KE8.2A	7.79	8.61	10	7.02	200	124	12.1
1.5KE9.1	8.19	10.0	1.0	7.37	50	109	13.8
1.5KE9.1A	8.65	9.55	1.0	7.78	50	112	13.4
1.5KE10	9.00	11.0	1.0	8.10	10	100	15.0
1.5KE10A	9.50	10.5	1.0	8.55	10	103	14.5
1.5KE11	9.90	12.1	1.0	8.92	5.0	92.6	16.2
1.5KE11A	10.5	11.6	1.0	9.40	5.0	96.2	15.6
1.5KE12	10.8	13.2	1.0	9.72	5.0	86.7	17.3
1.5KE12A	11.4	12.6	1.0	10.2	5.0	89.8	16.7
1.5KE13	11.7	14.3	1.0	10.5	5.0	78.9	19.0
1.5KE13A	12.4	13.7	1.0	11.1	5.0	82.4	18.2
1.5KE15	13.5	16.5	1.0	12.1	5.0	68.2	22.0
1.5KE15A	14.3	15.8	1.0	12.8	5.0	70.8	21.2
1.5KE16	14.4	17.6	1.0	12.9	5.0	63.8	23.5
1.5KE16A	15.2	16.8	1.0	13.6	5.0	66.7	22.5
1.5KE18	16.2	19.8	1.0	14.5	5.0	56.6	26.5
1.5KE18A	17.1	18.9	1.0	15.3	5.0	59.5	25.2
1.5KE20	18.0	22.0	1.0	16.2	5.0	51.5	29.1
1.5KE20A	19.0	21.0	1.0	17.1	5.0	54.2	27.7
1.5KE22	19.8	24.2	1.0	17.8	5.0	47	31.9
1.5KE22A	20.9	23.1	1.0	18.8	5.0	49	30.6
1.5KE24	21.6	26.4	1.0	19.4	5.0	43.2	34.7
1.5KE24A	22.8	25.2	1.0	20.5	5.0	45.2	33.2
1.5KE27	24.3	29.7	1.0	21.8	5.0	38.4	39.1
1.5KE27A	25.7	28.4	1.0	23.1	5.0	40	37.5
1.5KE30	27.0	33.0	1.0	24.3	5.0	34.5	43.5
1.5KE30A	28.5	31.5	1.0	25.6	5.0	36.2	41.4
1.5KE33	29.7	36.3	1.0	26.8	5.0	31.4	47.7
1.5KE33A	31.4	34.7	1.0	28.2	5.0	32.8	45.7
1.5KE36	32.4	39.6	1.0	29.1	5.0	28.8	52.0
1.5KE36A	34.2	37.8	1.0	30.8	5.0	30.1	49.9
1.5KE39	35.1	42.9	1.0	31.6	5.0	26.6	56.4
1.5KE39A	37.1	41.0	1.0	33.3	5.0	27.8	53.9
1.5KE43	38.7	47.3	1.0	34.8	5.0	24.2	61.9
1.5KE43A	40.9	45.2	1.0	36.8	5.0	25.3	59.3
1.5KE47	42.3	51.7	1.0	38.1	5.0	22.1	67.8
1.5KE47A	44.7	49.4	1.0	40.2	5.0	23.1	64.8
1.5KE51	45.9	56.1	1.0	41.3	5.0	20.4	73.5
1.5KE51A	48.5	53.6	1.0	43.6	5.0	21.4	70.1
1.5KE56	50.4	61.6	1.0	45.4	5.0	18.6	80.5
1.5KE56A	53.2	58.8	1.0	47.8	5.0	19.5	77.0

TRANSIENT VOLTAGE SUPPRESSORS

1500W SERIES TVS DIODES/ 1.5KE (CASE 10) 1500W

TYPE	Breakdown Voltage		@I _T (mA)	Reverse Stand off Voltage V _{WM} (Volts)	Maximum Reverse Leakage at V _{WM} I _D (uA)	Maximum Peak Pulse Current I _{PPM} (Amps)	Maximum Clamping Voltage at I _{PPM} V _C (Volts)
	V _{BR} (Volts)						
	MIN.	MAX.					
1.5KE62	55.8	68.2	1.0	50.2	5.0	16.9	89.0
1.5KE62A	58.9	65.1	1.0	53.0	5.0	17.6	85.0
1.5KE68	61.2	74.8	1.0	55.1	5.0	15.3	98.0
1.5KE68A	64.6	71.4	1.0	58.1	5.0	16.3	92.0
1.5KE75	67.5	82.5	1.0	60.7	5.0	13.9	109
1.5KE75A	71.3	78.8	1.0	64.1	5.0	14.6	104
1.5KE82	73.8	90.2	1.0	66.4	5.0	12.7	118
1.5KE82A	77.9	86.1	1.0	70.1	5.0	13.3	113
1.5KE91	81.9	100	1.0	73.7	5.0	11.5	131
1.5KE91A	86.5	95.5	1.0	77.8	5.0	12.0	125
1.5KE100	90.0	110	1.0	81.0	5.0	10.4	144
1.5KE100A	95.0	105	1.0	85.5	5.0	10.9	137
1.5KE110	99.0	121	1.0	89.2	5.0	9.5	158
1.5KE110A	105	116	1.0	94.0	5.0	9.9	152
1.5KE120	108	132	1.0	97.2	5.0	8.7	173
1.5KE120A	114	126	1.0	102	5.0	9.1	165
1.5KE130	117	143	1.0	105	5.0	8.0	187
1.5KE130A	124	137	1.0	111	5.0	8.4	179
1.5KE150	135	165	1.0	121	5.0	7.0	215
1.5KE150A	143	158	1.0	128	5.0	7.2	207
1.5KE160	144	176	1.0	130	5.0	6.5	230
1.5KE160A	152	168	1.0	136	5.0	6.8	219
1.5KE170	153	187	1.0	138	5.0	6.1	244
1.5KE170A	162	179	1.0	145	5.0	6.4	234
1.5KE180	162	198	1.0	146	5.0	5.8	258
1.5KE180A	171	189	1.0	154	5.0	6.1	246
1.5KE200	180	220	1.0	162	5.0	5.2	287
1.5KE200A	190	210	1.0	171	5.0	5.5	274
1.5KE220	198	242	1.0	175	5.0	4.4	344
1.5KE220A	209	231	1.0	185	5.0	4.6	328
1.5KE250	225	275	1.0	202	5.0	4.2	360
1.5KE250A	237	263	1.0	214	5.0	4.4	344
1.5KE300	270	330	1.0	243	5.0	3.5	430
1.5KE300A	285	315	1.0	256	5.0	3.6	414
1.5KE350	315	385	1.0	284	5.0	3.0	504
1.5KE350A	333	368	1.0	300	5.0	3.1	482
1.5KE400	360	440	1.0	324	5.0	2.6	574
1.5KE400A	380	420	1.0	342	5.0	2.7	548
1.5KE440	396	484	1.0	356	5.0	2.4	631
1.5KE440A	418	462	1.0	376	5.0	2.5	602
1.5KE480A	456	504	1.0	408	5.0	2.3	658
1.5KE510A	485	535	1.0	434	5.0	2.1	698
1.5KE530A	503.5	556.5	1.0	477	5.0	2.1	725
1.5KE540A	513	567	1.0	486	5.0	2.0	740
1.5KE550A	522.5	577.5	1.0	495	5.0	2.0	760
1.5KE600A	570	630	1.0	512	5.0	1.8	828

- Notes :
1. V_{BR} measured after I_T applied for 300ms. I_T = square pulse or equivalent.
 2. For bidirectional use C or CA suffixs for all types (ex. 1.5KE6.8C, 1.5KE600CA) electrical characteristics apply in both directions.
 3. For bidirectional types having V_{WM} of 10 volts and less, the I_D limit is doubled.
 4. All devices UL listed file# E211196.



Attachment information about 1.5KEXX (C) A

1. Internal Circuit



2. Marking on the body

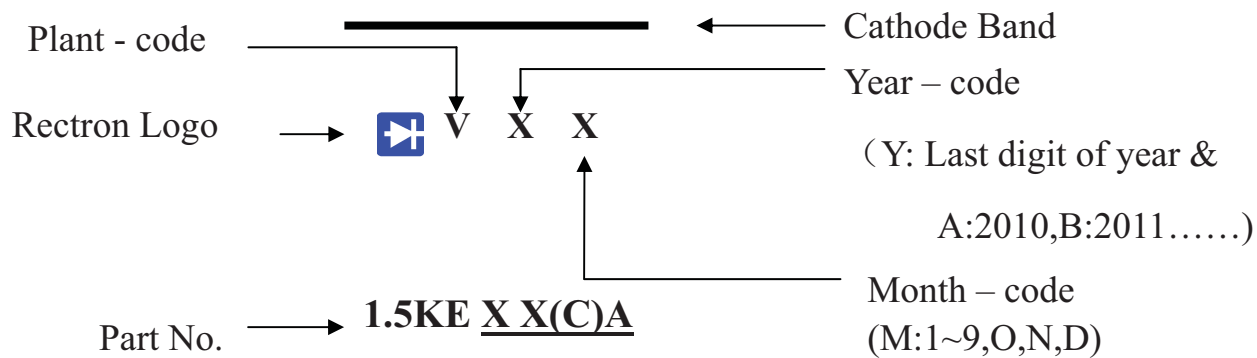

PACKAGING OF DIODE AND BRIDGE RECTIFIERS

REEL PACK

PACKAGE	PACKING CODE	EA PER REEL	EA PER INNER BOX	COMPONENT SPACE (mm)	TAPE SPACE (mm)	REEL DIA (mm)	CARTON SIZE (mm)	EA PER CARTON	GROSS WEIGHT(Kg)
1.5KE	-T	1,200	1,200	10.0	52	330	355*350*335	4,800	8.05

DISCLAIMER NOTICE

Rectron Inc reserves the right to make changes without notice to any product specification herein, to make corrections, modifications, enhancements or other changes. Rectron Inc or anyone on its behalf assumes no responsibility or liability for any errors or inaccuracies. Data sheet specifications and its information contained are intended to provide a product description only. "Typical" parameters which may be included on RECTRON data sheets and/ or specifications can and do vary in different applications and actual performance may vary over time. Rectron Inc does not assume any liability arising out of the application or use of any product or circuit.

Rectron products are not designed, intended or authorized for use in medical, life-saving implant or other applications intended for life-sustaining or other related applications where a failure or malfunction of component or circuitry may directly or indirectly cause injury or threaten a life without expressed written approval of Rectron Inc. Customers using or selling Rectron components for use in such applications do so at their own risk and shall agree to fully indemnify Rectron Inc and its subsidiaries harmless against all claims, damages and expenditures.