

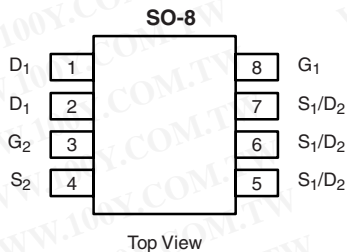

## Dual N-Channel 30-V (D-S) MOSFET with Schottky Diode

PRODUCT SUMMARY				
	$V_{DS}$ (V)	$R_{DS(on)}$ ( $\Omega$ )	$I_D$ (A) <sup>a</sup>	$Q_g$ (Typ.)
Channel-1	30	0.018 at $V_{GS} = 10$ V	10	6.6
		0.023 at $V_{GS} = 4.5$ V	8.5	
Channel-2		0.018 at $V_{GS} = 10$ V	10.5	8.9
		0.022 at $V_{GS} = 4.5$ V	9.3	

SCHOTTKY PRODUCT SUMMARY		
$V_{DS}$ (V)	$V_{SD}$ (V) Diode Forward Voltage	$I_F$ (A)
30	0.50 V at 1.0 A	2.0



Ordering Information: Si4916DY-T1-E3 (Lead (Pb)-free)  
 Si4916DY-T1-GE3 (Lead (Pb)-free and Halogen-free)

### FEATURES

- Halogen-free According to IEC 61249-2-21 Available
- LITTLE FOOT<sup>®</sup> Plus Integrated Schottky
- 100 %  $R_g$  Tested

### APPLICATIONS

- DC/DC Converters
- Notebook



**RoHS**  
 COMPLIANT  
 HALOGEN  
**FREE**  
 Available

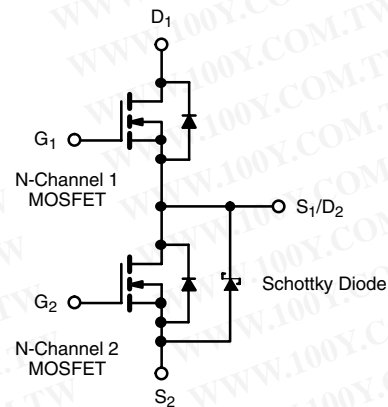

ABSOLUTE MAXIMUM RATINGS $T_A = 25$ °C, unless otherwise noted					
Parameter	Symbol	Channel-1	Channel-2	Unit	
Drain-Source Voltage	$V_{DS}$	30		V	
Gate-Source Voltage	$V_{GS}$	20			
Continuous Drain Current ( $T_J = 150$ °C) <sup>a, b</sup>	$I_D$	$T_C = 25$ °C	10	10.5	A
		$T_C = 70$ °C	8	8.3	
		$T_A = 25$ °C	7.5 <sup>a, b, c</sup>	7.8 <sup>a, b, c</sup>	
		$T_A = 70$ °C	6 <sup>a, b, c</sup>	6.3 <sup>a, b, c</sup>	
Pulsed Drain Current (10 $\mu$ s Pulse Width)	$I_{DM}$	40	40	A	
Continuous Source-Drain Diode Current	$I_S$	$T_C = 25$ °C	3	3.2	A
		$T_A = 25$ °C	1.7 <sup>a, b, c</sup>	1.8 <sup>a, b, c</sup>	
PulseD Source-Drain Current	$I_{SM}$	40	40	A	
Single-Pulse Avalanche Current	$I_{AS}$	15		mJ	
Single-Pulse Avalanche Energy	$E_{AS}$	11.2			
Maximum Power Dissipation <sup>a, b</sup>	$P_D$	$T_C = 25$ °C	3.3	3.5	W
		$T_C = 70$ °C	2.1	2.2	
		$T_A = 25$ °C	1.9 <sup>a, b, c</sup>	2.0 <sup>a, b, c</sup>	
		$T_A = 70$ °C	1.2 <sup>a, b, c</sup>	1.3 <sup>a, b, c</sup>	
Operating Junction and Storage Temperature Range	$T_J, T_{stg}$	- 55 to 150		°C	

Notes:

a. Based on  $T_C = 25$  °C.

b. Surface Mounted on 1" x 1" FR4 board.

c. t = 10 s.

**THERMAL RESISTANCE RATINGS**

Parameter	Symbol	Channel-1		Channel-2		Unit	
		Typ.	Max.	Typ.	Max.		
Maximum Junction-to-Ambient <sup>a</sup>	$t \leq 10 \text{ s}$	$R_{thJA}$	54	65	47	60	°C/W
Maximum Junction-to-Foot (Drain)	Steady State	$R_{thJF}$	32	38	30	35	

Notes:

a. Surface Mounted on 1" x 1" FR4 board.

b. Maximum under Steady State conditions is 112 °C/W for Channel 1 and 107 °C/W for Channel 2.

**MOSFET SPECIFICATIONS**  $T_J = 25 \text{ }^\circ\text{C}$ , unless otherwise noted

Parameter	Symbol	Test Conditions	Min.	Typ. <sup>a</sup>	Max.	Unit	
<b>Static</b>							
Drain-Source Breakdown Voltage	$V_{DS}$	$V_{GS} = 0 \text{ V}, I_D = 250 \text{ } \mu\text{A}$	Ch-1 30 Ch-2 30			V	
$V_{DS}$ Temperature Coefficient	$\Delta V_{DS}/T_J$	$I_D = 250 \text{ } \mu\text{A}$	Ch-1 Ch-2	24 25		mV/°C	
$V_{GS(th)}$ Temperature Coefficient	$\Delta V_{GS(th)}/T_J$		Ch-1 Ch-2	-6 -6			V
Gate Threshold Voltage	$V_{GS(th)}$	$V_{DS} = V_{GS}, I_D = 250 \text{ } \mu\text{A}$	Ch-1 Ch-2	1.5 1.5	3.0 2.7		
Gate-Body Leakage	$I_{GSS}$	$V_{DS} = 0 \text{ V}, V_{GS} = 20 \text{ V}$	Ch-1 Ch-2		100 100	nA	
Zero Gate Voltage Drain Current	$I_{DSS}$	$V_{DS} = 30 \text{ V}, V_{GS} = 0 \text{ V}$	Ch-1 Ch-2		1 100	$\mu\text{A}$	
		$V_{DS} = 30 \text{ V}, V_{GS} = 0 \text{ V}, T_J = 85 \text{ }^\circ\text{C}$	Ch-1 Ch-2		15 2000		
On-State Drain Current <sup>b</sup>	$I_{D(on)}$	$V_{DS} = 5 \text{ V}, V_{GS} = 10 \text{ V}$	Ch-1 Ch-2	20 20		A	
Drain-Source On-State Resistance <sup>b</sup>	$R_{DS(on)}$	$V_{GS} = 10 \text{ V}, I_D = 10 \text{ A}$	Ch-1		0.0145	0.018	$\Omega$
		$V_{GS} = 10 \text{ V}, I_D = 10.5 \text{ A}$	Ch-2		0.015	0.018	
		$V_{GS} = 4.5 \text{ V}, I_D = 8.5 \text{ A}$	Ch-1		0.019	0.023	
		$V_{GS} = 4.5 \text{ V}, I_D = 9.3 \text{ A}$	Ch-2		0.018	0.022	
Forward Transconductance <sup>b</sup>	$g_{fs}$	$V_{DS} = 15 \text{ V}, I_D = 10 \text{ A}$	Ch-1		30	S	
		$V_{DS} = 15 \text{ V}, I_D = 10.5 \text{ A}$	Ch-2		35		
Diode Forward Voltage <sup>b</sup>	$V_{SD}$	$I_S = 1.7 \text{ A}, V_{GS} = 0 \text{ V}$	Ch-1		0.75	1.1	V
		$I_S = 1 \text{ A}, V_{GS} = 0 \text{ V}$	Ch-2		0.47	0.5	
<b>Dynamic<sup>a</sup></b>							
Total Gate Charge	$Q_g$	Channel-1 $V_{DS} = 15 \text{ V}, V_{GS} = 4.5 \text{ V}, I_D = 10 \text{ A}$	Ch-1		6.6	10	nC
			Ch-2		8.9	14	
Gate-Source Charge	$Q_{gs}$	Channel-2 $V_{DS} = 15 \text{ V}, V_{GS} = 4.5 \text{ V}, I_D = -10.5 \text{ A}$	Ch-1		2.9		
			Ch-2		3.4		
Gate-Drain Charge	$Q_{gd}$	Channel-2 $V_{DS} = 15 \text{ V}, V_{GS} = 4.5 \text{ V}, I_D = -10.5 \text{ A}$	Ch-1		2.3		
			Ch-2		2.4		
Gate Resistance	$R_g$		Ch-1	0.5	1.9	2.9	$\Omega$
			Ch-2	0.5	2.3	3.5	



<b>MOSFET SPECIFICATIONS</b> $T_J = 25\text{ }^\circ\text{C}$ , unless otherwise noted						
Parameter	Symbol	Test Conditions	Min.	Typ. <sup>a</sup>	Max.	Unit
<b>Dynamic<sup>a</sup></b>						
Turn-On Delay Time	$t_{d(on)}$	Channel-1 $V_{DD} = 15\text{ V}$ , $R_L = 15\ \Omega$ $I_D \cong 1\text{ A}$ , $V_{GEN} = 10\text{ V}$ , $R_g = 6\ \Omega$	Ch-1	8	15	ns
Rise Time	$t_r$		Ch-2	9	15	
Turn-Off Delay Time	$t_{d(off)}$	Channel-2 $V_{DD} = 15\text{ V}$ , $R_L = 15\ \Omega$ $I_D \cong 1\text{ A}$ , $V_{GEN} = 10\text{ V}$ , $R_g = 6\ \Omega$	Ch-1	11	18	
			Ch-2	13	20	
Fall Time	$t_f$		Ch-1	21	32	
			Ch-2	27	40	
Source-Drain Reverse Recovery Time	$t_{rr}$	$I_F = 1.3\text{ A}$ , $dI/dt = 100\text{ A}/\mu\text{s}$ $I_F = 2.2\text{ A}$ , $dI/dt = 100\ \mu\text{A}/\mu\text{s}$	Ch-1	28	40	
			Ch-2	24	35	
Body Diode Reverse Recovery Charge	$Q_{rr}$	$I_F = 1.3\text{ A}$ , $dI/dt = 100\text{ A}/\mu\text{s}$ $I_F = 2.2\text{ A}$ , $dI/dt = 100\ \mu\text{A}/\mu\text{s}$	Ch-1	17		nC
			Ch-2	12		
Reverse Recovery Fall Time	$t_a$	$I_F = 1.3\text{ A}$ , $dI/dt = 100\text{ A}/\mu\text{s}$ $I_F = 2.2\text{ A}$ , $dI/dt = 100\ \mu\text{A}/\mu\text{s}$	Ch-1	12		ns
			Ch-2	11		
Reverse Recovery Rise Time	$t_b$	$I_F = 1.3\text{ A}$ , $dI/dt = 100\text{ A}/\mu\text{s}$ $I_F = 2.2\text{ A}$ , $dI/dt = 100\ \mu\text{A}/\mu\text{s}$	Ch-1	16		
			Ch-2	13		

Notes:

- a. Guaranteed by design, not subject to production testing.
- b. Pulse test; pulse width  $\leq 300\ \mu\text{s}$ , duty cycle  $\leq 2\%$ .

<b>SCHOTTKY SPECIFICATIONS</b> $T_J = 25\text{ }^\circ\text{C}$ , unless otherwise noted						
Parameter	Symbol	Test Conditions	Min.	Typ.	Max.	Unit
Forward Voltage Drop	$V_F$	$I_F = 1.0\text{ A}$		0.47	0.50	V
		$I_F = 1.0\text{ A}$ , $T_J = 125\text{ }^\circ\text{C}$		0.36	0.42	
Maximum Reverse Leakage Current	$I_{rm}$	$V_R = 30\text{ V}$		0.004	0.100	mA
		$V_R = 30\text{ V}$ , $T_J = 100\text{ }^\circ\text{C}$		0.7	10	
		$V_R = -30\text{ V}$ , $T_J = 125\text{ }^\circ\text{C}$		3.0	20	
Junction Capacitance	$C_T$	$V_R = 10\text{ V}$		50		pF

Stresses beyond those listed under "Absolute Maximum Ratings" may cause permanent damage to the device. These are stress ratings only, and functional operation of the device at these or any other conditions beyond those indicated in the operational sections of the specifications is not implied. Exposure to absolute maximum rating conditions for extended periods may affect device reliability.

勝特力材料 886-3-5753170  
 勝特力电子(上海) 86-21-34970699  
 勝特力电子(深圳) 86-755-83298787  
[Http://www.100y.com.tw](http://www.100y.com.tw)



## CHANNEL-1 TYPICAL CHARACTERISTICS 25 °C, unless otherwise noted

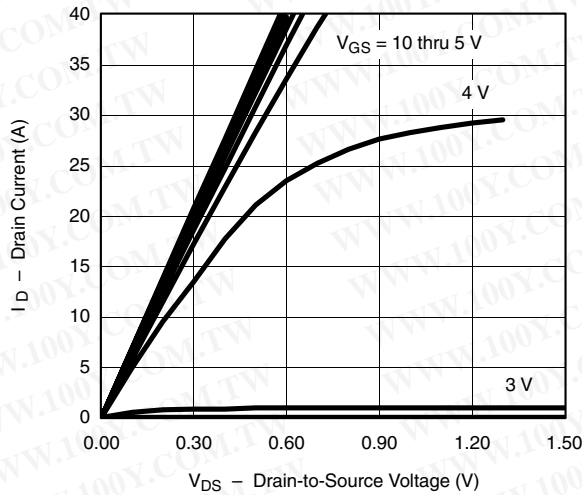

Output Characteristics

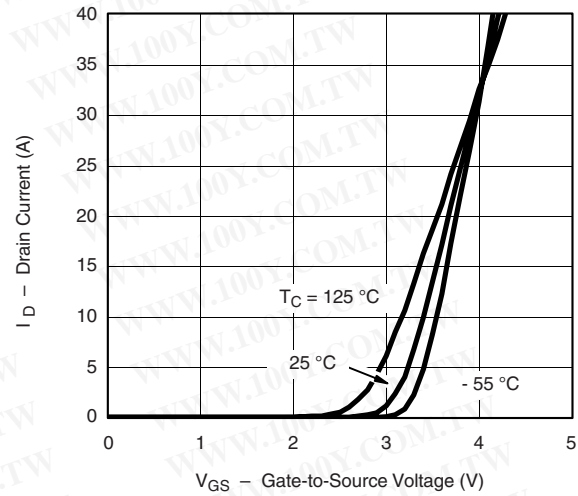

Transfer Characteristics

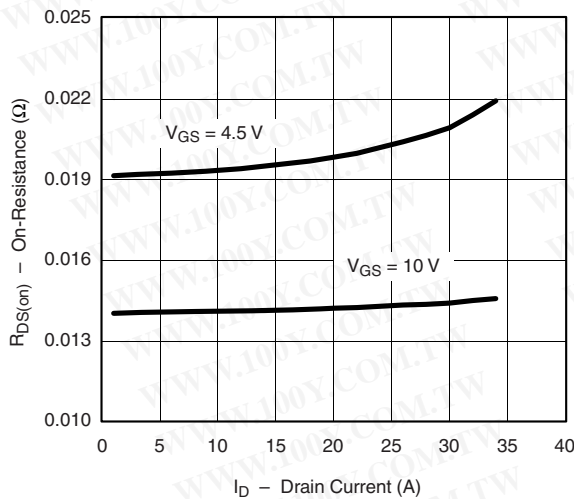

On-Resistance vs. Drain Current

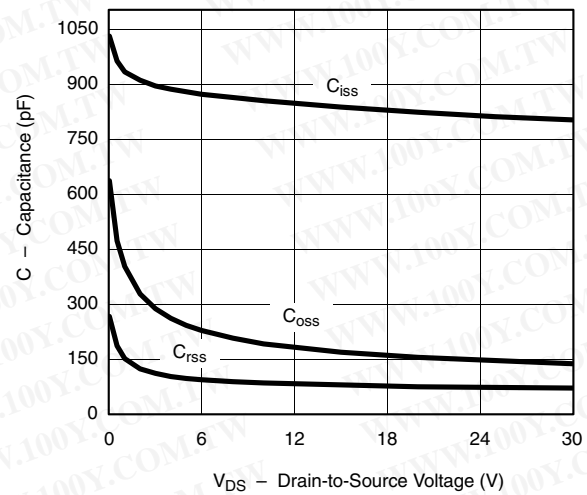

Capacitance

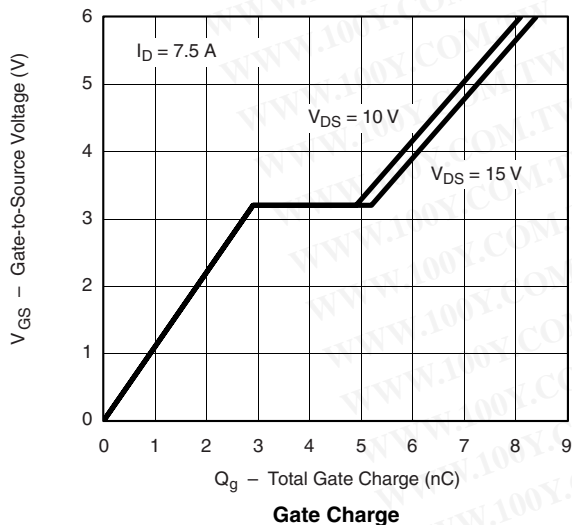

Gate Charge

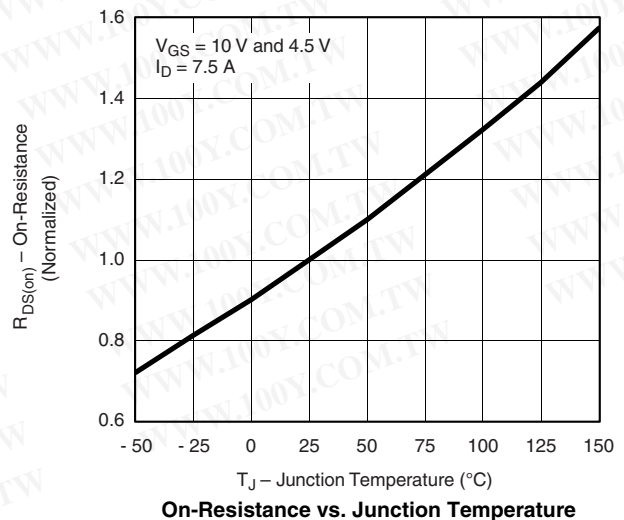

On-Resistance vs. Junction Temperature



**CHANNEL-1 TYPICAL CHARACTERISTICS** 25 °C, unless otherwise noted

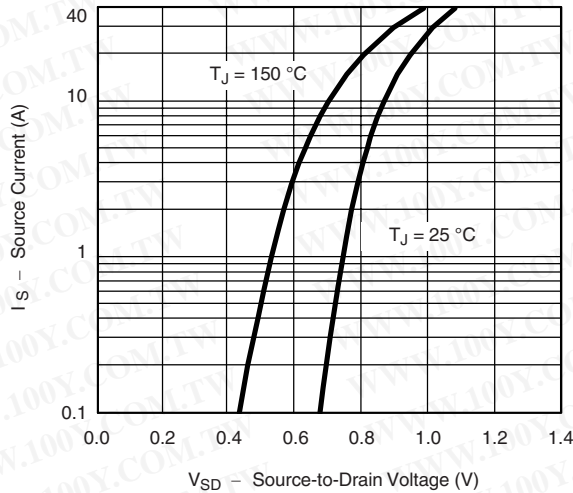

Source-Drain Diode Forward Voltage

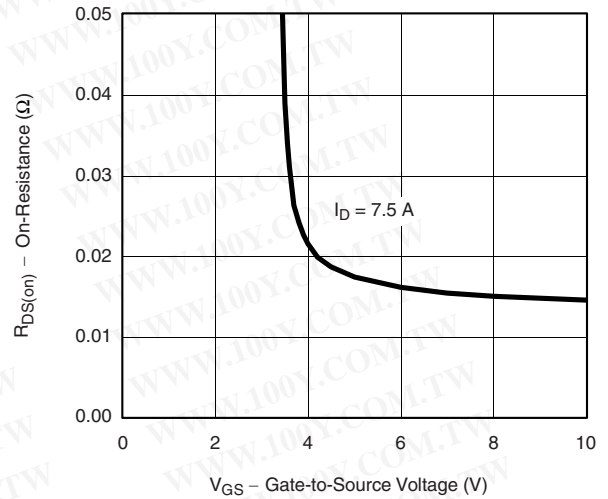

On-Resistance vs. Gate-to-Source Voltage

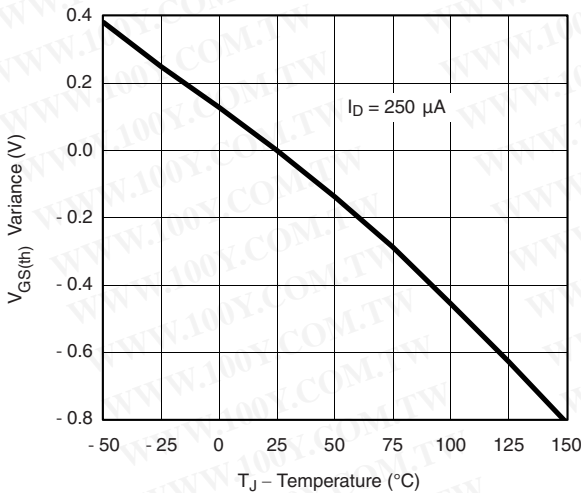

Threshold Voltage

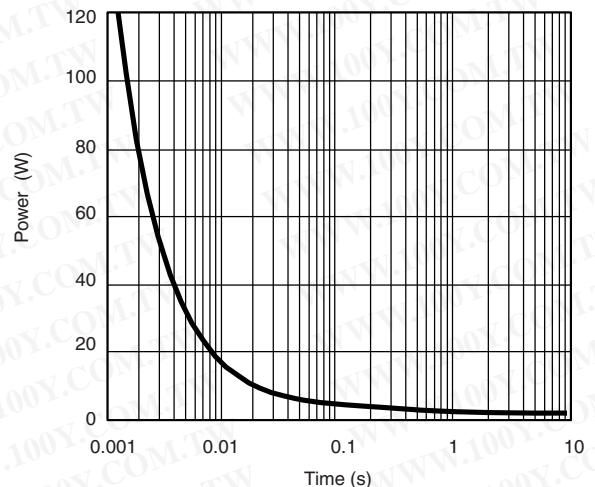

Single Pulse Power, Junction-to-Ambient

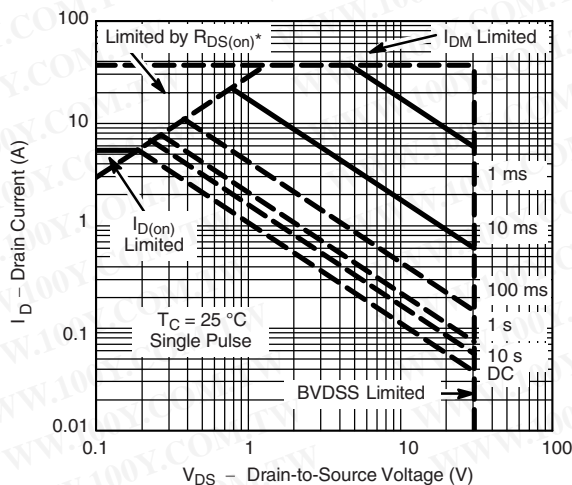

\*  $V_{GS} >$  minimum  $V_{GS}$  at which  $R_{DS(on)}$  is specified

Safe Operating Area

### CHANNEL-1 TYPICAL CHARACTERISTICS 25 °C, unless otherwise noted

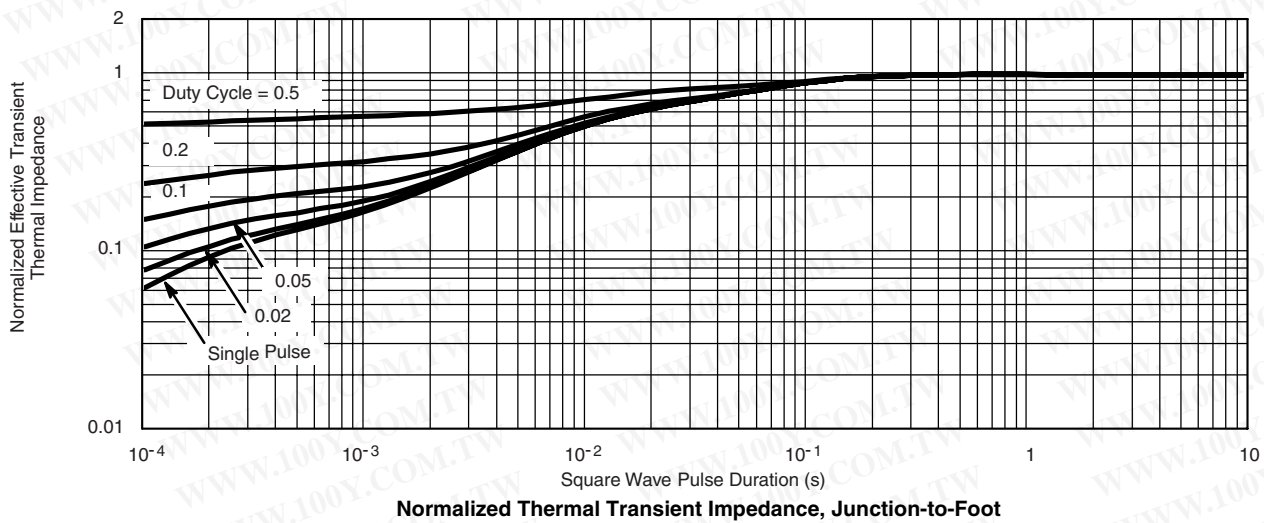
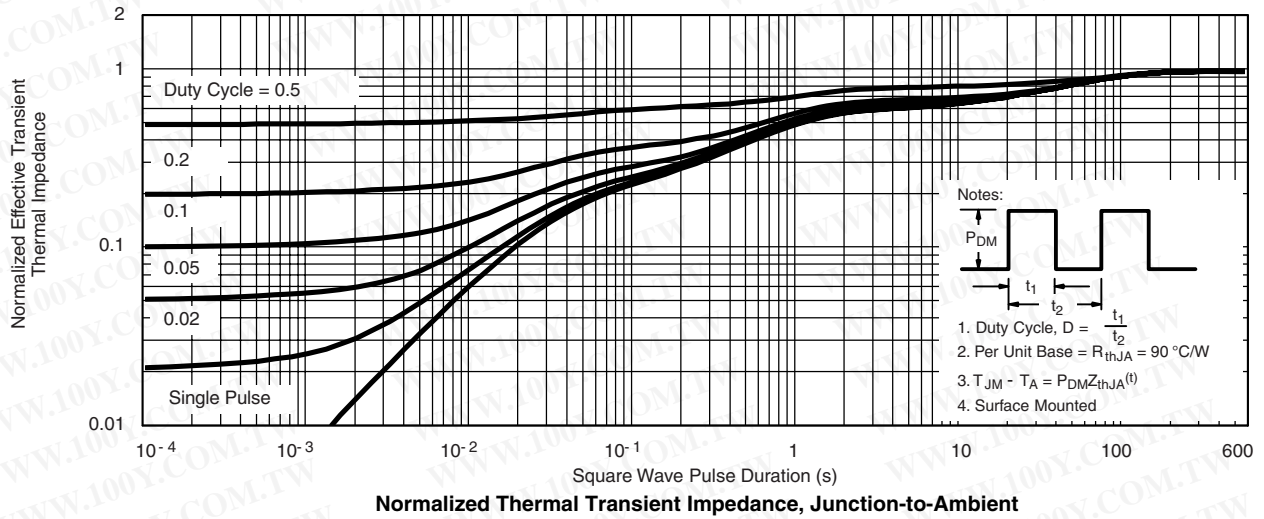

勝特力材料 886-3-5753170  
 勝特力电子(上海) 86-21-34970699  
 勝特力电子(深圳) 86-755-83298787  
[Http://www.100y.com.tw](http://www.100y.com.tw)



**CHANNEL-2 TYPICAL CHARACTERISTICS** 25 °C, unless otherwise noted

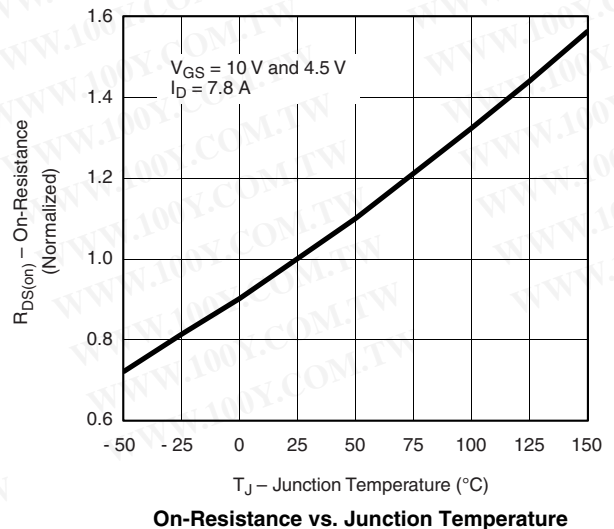
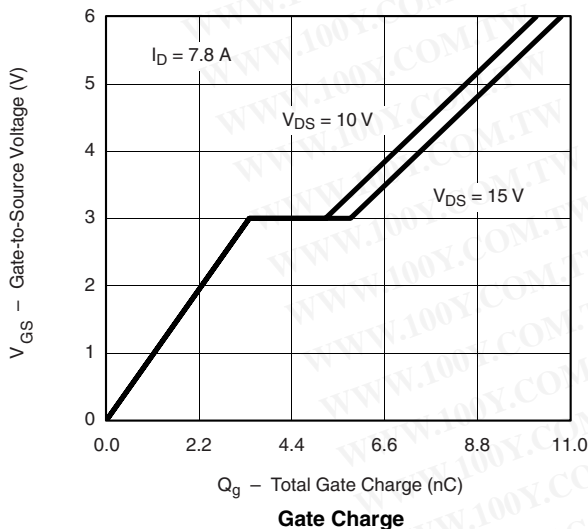
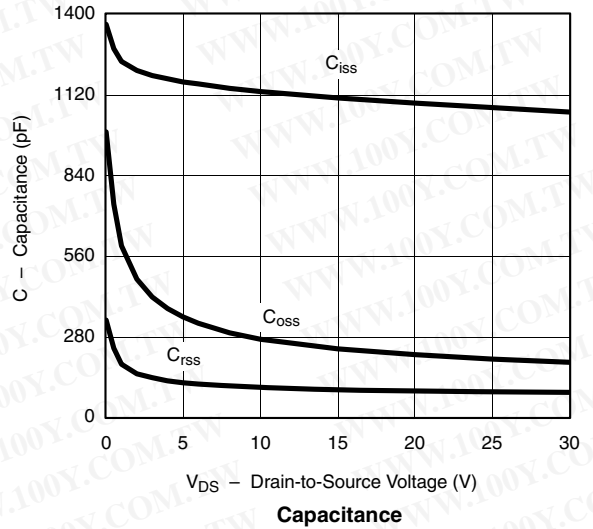
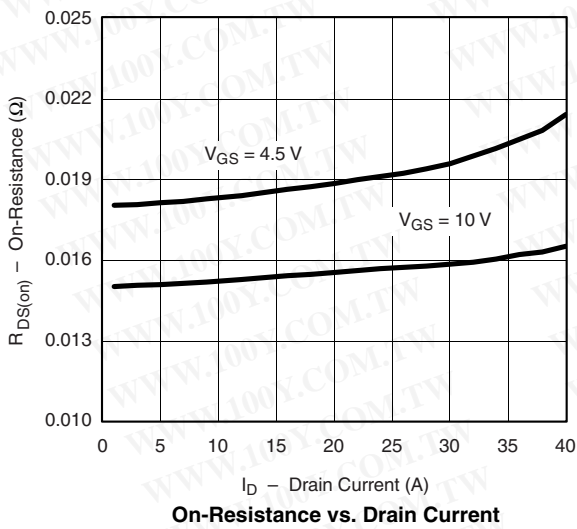
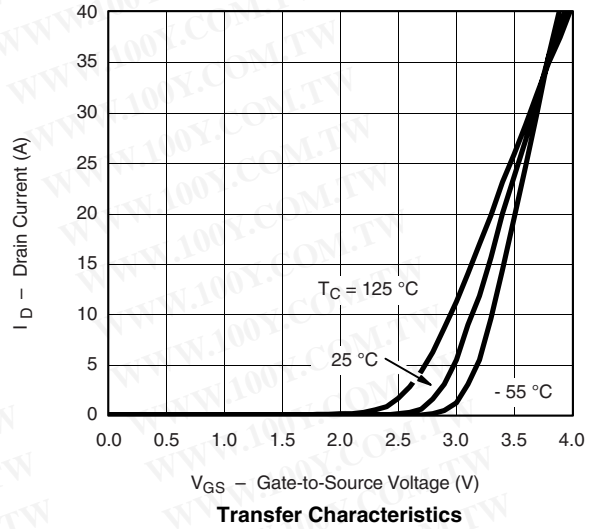
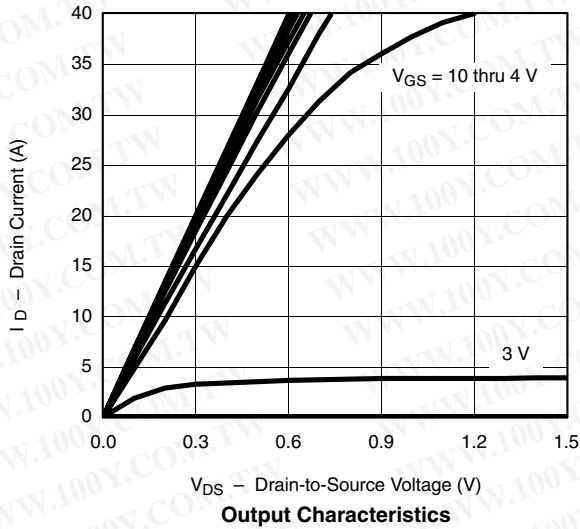

# Si4916DY

Vishay Siliconix

勝特力材料 886-3-5753170  
 勝特力电子(上海) 86-21-34970699  
 勝特力电子(深圳) 86-755-83298787  
[Http://www.100y.com.tw](http://www.100y.com.tw)



## CHANNEL-2 TYPICAL CHARACTERISTICS 25 °C, unless otherwise noted

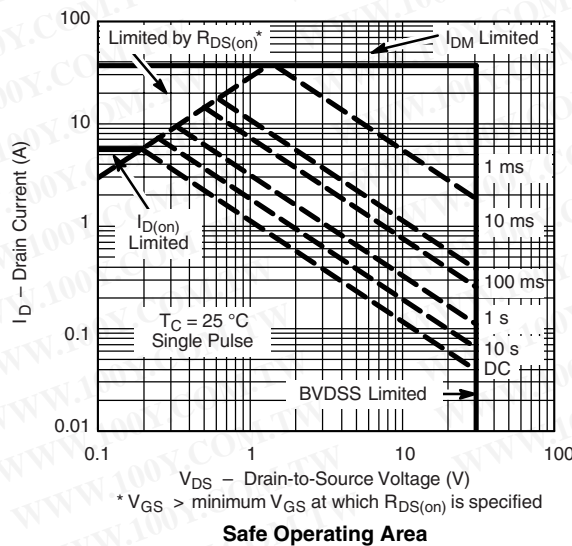
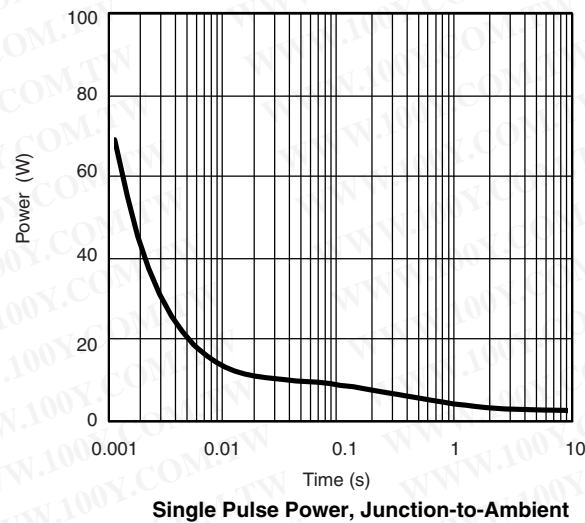
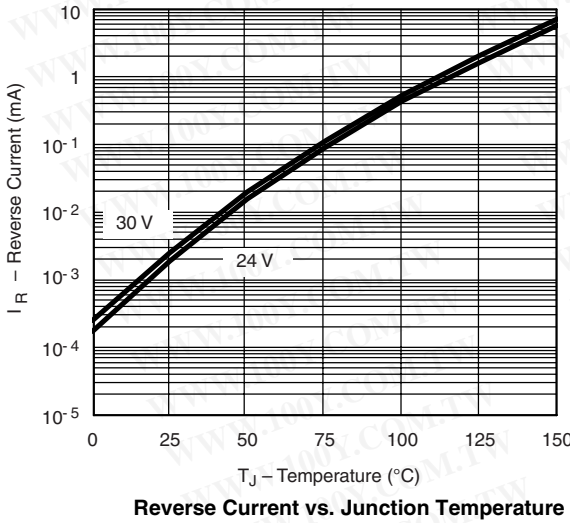
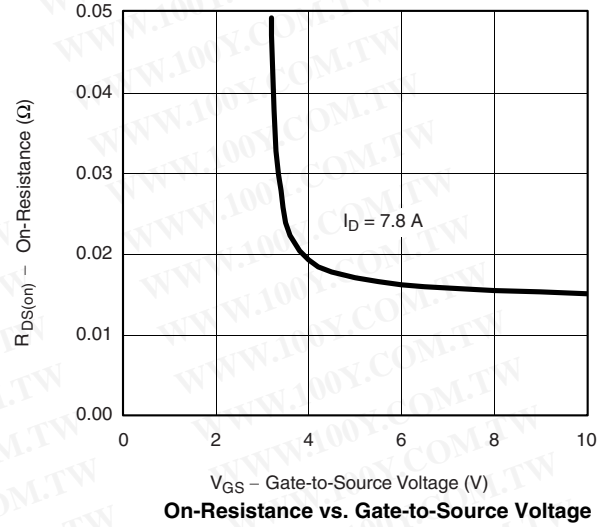
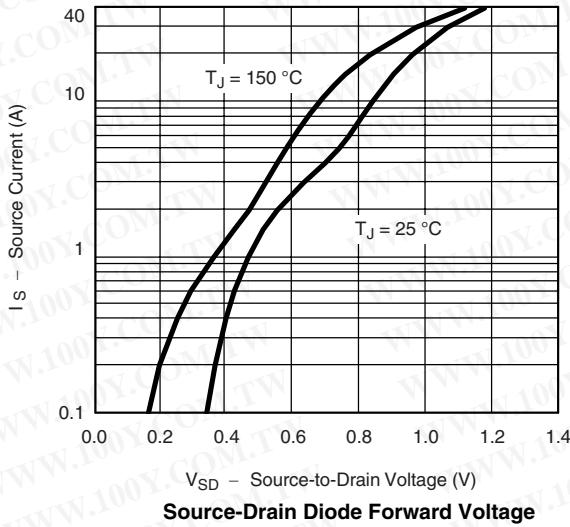





**CHANNEL-2 TYPICAL CHARACTERISTICS** 25 °C, unless otherwise noted

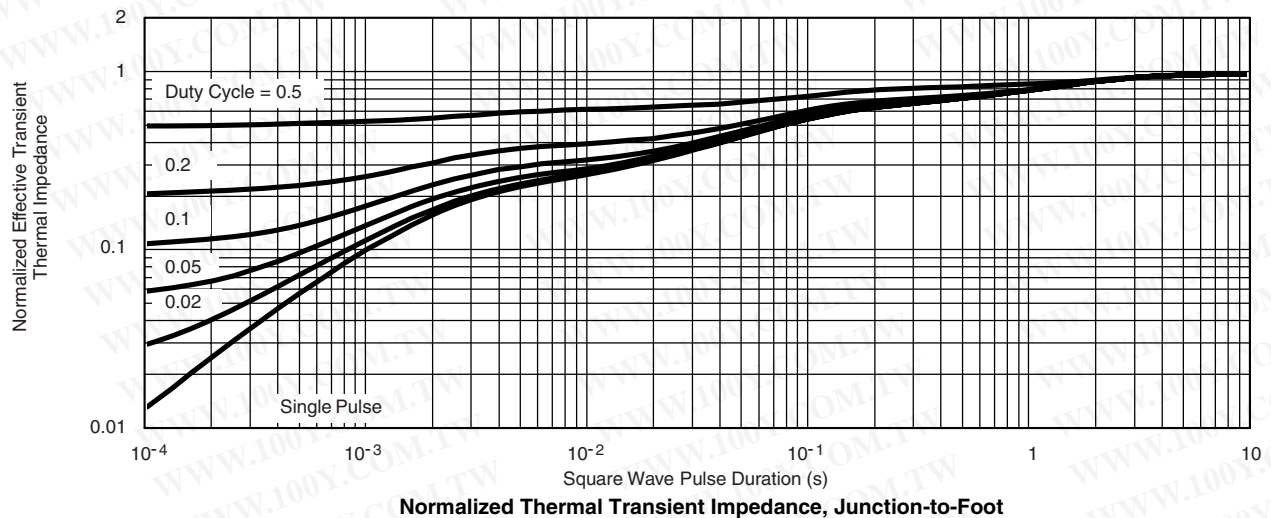
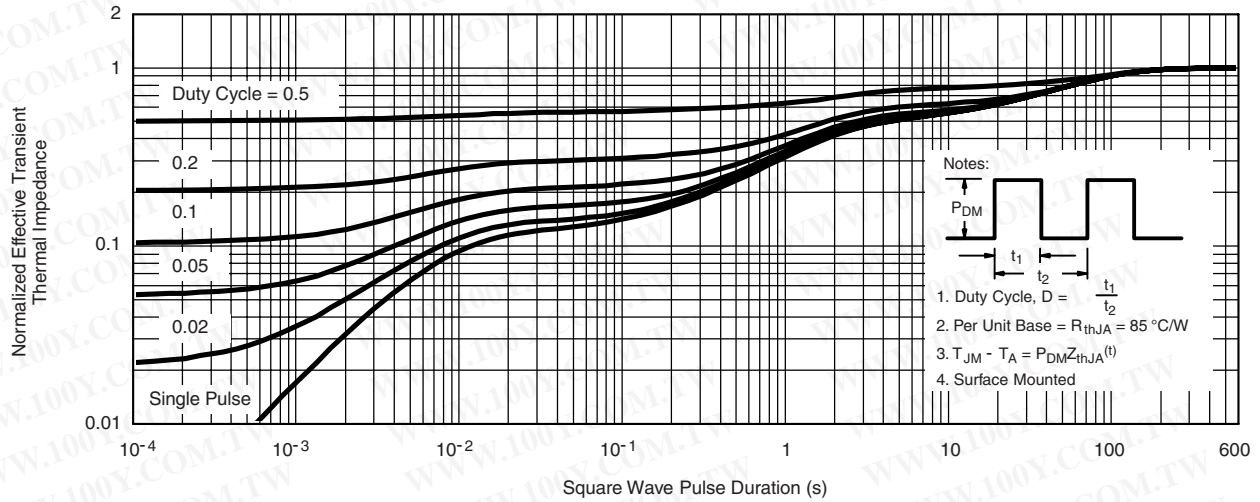

勝特力材料 886-3-5753170  
勝特力电子(上海) 86-21-34970699  
勝特力电子(深圳) 86-755-83298787  
[Http://www.100y.com.tw](http://www.100y.com.tw)

Vishay Siliconix maintains worldwide manufacturing capability. Products may be manufactured at one of several qualified locations. Reliability data for Silicon Technology and Package Reliability represent a composite of all qualified locations. For related documents such as package/tape drawings, part marking, and reliability data, see [www.vishay.com/bpg?74331](http://www.vishay.com/bpg?74331).



勝特力材料 886-3-5753170  
 勝特力电子(上海) 86-21-34970699  
 勝特力电子(深圳) 86-755-83298787  
[Http://www.100y.com.tw](http://www.100y.com.tw)

**SOIC (NARROW): 8-LEAD**  
 JEDEC Part Number: MS-012

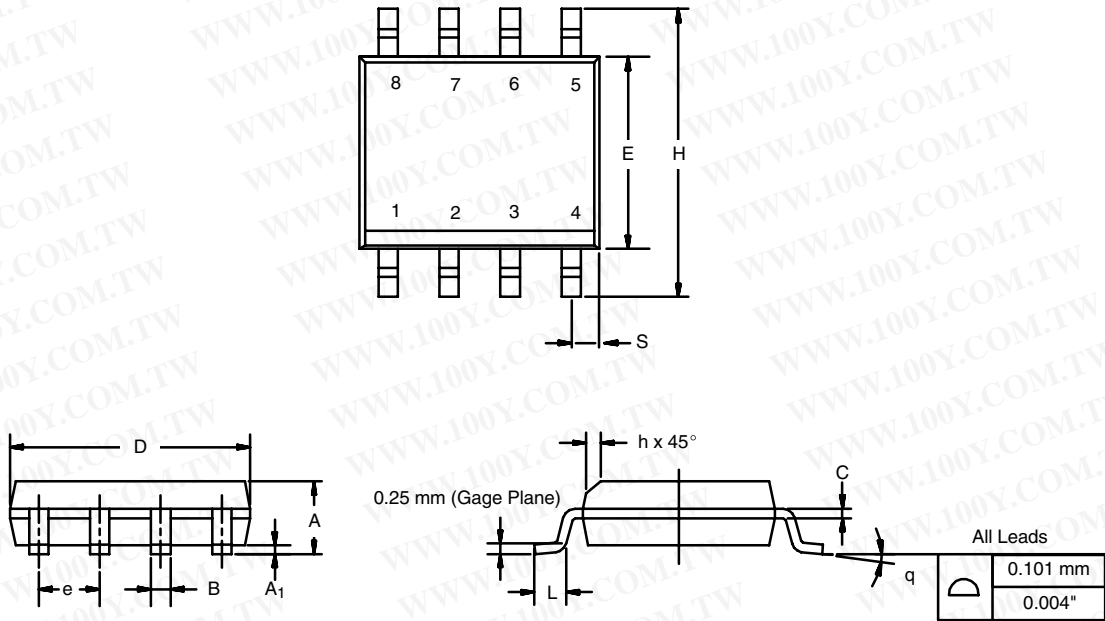

DIM	MILLIMETERS		INCHES	
	Min	Max	Min	Max
A	1.35	1.75	0.053	0.069
A <sub>1</sub>	0.10	0.20	0.004	0.008
B	0.35	0.51	0.014	0.020
C	0.19	0.25	0.0075	0.010
D	4.80	5.00	0.189	0.196
E	3.80	4.00	0.150	0.157
e	1.27 BSC		0.050 BSC	
H	5.80	6.20	0.228	0.244
h	0.25	0.50	0.010	0.020
L	0.50	0.93	0.020	0.037
q	0°	8°	0°	8°
S	0.44	0.64	0.018	0.026

ECN: C-06527-Rev. I, 11-Sep-06  
 DWG: 5498



## Mounting LITTLE FOOT®, SO-8 Power MOSFETs

Wharton McDaniel

Surface-mounted LITTLE FOOT power MOSFETs use integrated circuit and small-signal packages which have been modified to provide the heat transfer capabilities required by power devices. Leadframe materials and design, molding compounds, and die attach materials have been changed, while the footprint of the packages remains the same.

See Application Note 826, *Recommended Minimum Pad Patterns With Outline Drawing Access for Vishay Siliconix MOSFETs*, (<http://www.vishay.com/ppg?72286>), for the basis of the pad design for a LITTLE FOOT SO-8 power MOSFET. In converting this recommended minimum pad to the pad set for a power MOSFET, designers must make two connections: an electrical connection and a thermal connection, to draw heat away from the package.

In the case of the SO-8 package, the thermal connections are very simple. Pins 5, 6, 7, and 8 are the drain of the MOSFET for a single MOSFET package and are connected together. In a dual package, pins 5 and 6 are one drain, and pins 7 and 8 are the other drain. For a small-signal device or integrated circuit, typical connections would be made with traces that are 0.020 inches wide. Since the drain pins serve the additional function of providing the thermal connection to the package, this level of connection is inadequate. The total cross section of the copper may be adequate to carry the current required for the application, but it presents a large thermal impedance. Also, heat spreads in a circular fashion from the heat source. In this case the drain pins are the heat sources when looking at heat spread on the PC board.

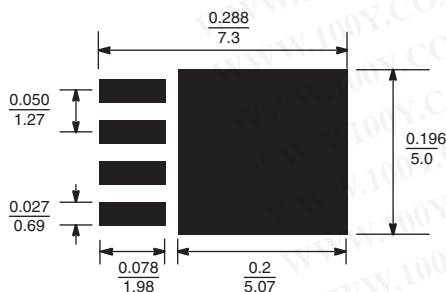

Figure 1. Single MOSFET SO-8 Pad Pattern With Copper Spreading

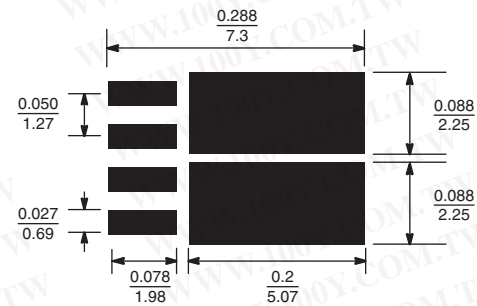

Figure 2. Dual MOSFET SO-8 Pad Pattern With Copper Spreading

The minimum recommended pad patterns for the single-MOSFET SO-8 with copper spreading (Figure 1) and dual-MOSFET SO-8 with copper spreading (Figure 2) show the starting point for utilizing the board area available for the heat-spreading copper. To create this pattern, a plane of copper overlies the drain pins. The copper plane connects the drain pins electrically, but more importantly provides planar copper to draw heat from the drain leads and start the process of spreading the heat so it can be dissipated into the ambient air. These patterns use all the available area underneath the body for this purpose.

Since surface-mounted packages are small, and reflow soldering is the most common way in which these are affixed to the PC board, “thermal” connections from the planar copper to the pads have not been used. Even if additional planar copper area is used, there should be no problems in the soldering process. The actual solder connections are defined by the solder mask openings. By combining the basic footprint with the copper plane on the drain pins, the solder mask generation occurs automatically.

A final item to keep in mind is the width of the power traces. The absolute minimum power trace width must be determined by the amount of current it has to carry. For thermal reasons, this minimum width should be at least 0.020 inches. The use of wide traces connected to the drain plane provides a low impedance path for heat to move away from the device.

## RECOMMENDED MINIMUM PADS FOR SO-8

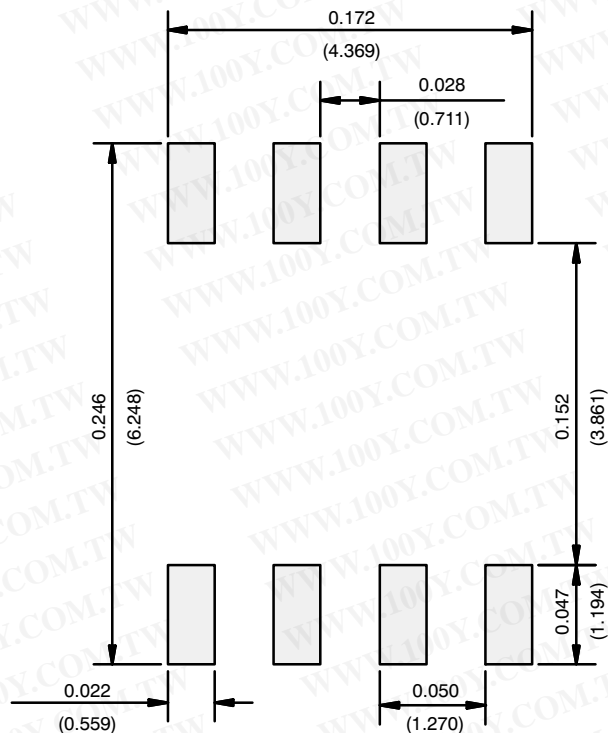

Recommended Minimum Pads  
Dimensions in Inches/(mm)

Return to Index

APPLICATION NOTE

勝特力材料 886-3-5753170  
勝特力电子(上海) 86-21-34970699  
勝特力电子(深圳) 86-755-83298787  
[Http://www.100y.com.tw](http://www.100y.com.tw)



## Disclaimer

ALL PRODUCT, PRODUCT SPECIFICATIONS AND DATA ARE SUBJECT TO CHANGE WITHOUT NOTICE TO IMPROVE RELIABILITY, FUNCTION OR DESIGN OR OTHERWISE.

Vishay Intertechnology, Inc., its affiliates, agents, and employees, and all persons acting on its or their behalf (collectively, "Vishay"), disclaim any and all liability for any errors, inaccuracies or incompleteness contained in any datasheet or in any other disclosure relating to any product.

Vishay makes no warranty, representation or guarantee regarding the suitability of the products for any particular purpose or the continuing production of any product. To the maximum extent permitted by applicable law, Vishay disclaims (i) any and all liability arising out of the application or use of any product, (ii) any and all liability, including without limitation special, consequential or incidental damages, and (iii) any and all implied warranties, including warranties of fitness for particular purpose, non-infringement and merchantability.

Statements regarding the suitability of products for certain types of applications are based on Vishay's knowledge of typical requirements that are often placed on Vishay products in generic applications. Such statements are not binding statements about the suitability of products for a particular application. It is the customer's responsibility to validate that a particular product with the properties described in the product specification is suitable for use in a particular application. Parameters provided in datasheets and/or specifications may vary in different applications and performance may vary over time. All operating parameters, including typical parameters, must be validated for each customer application by the customer's technical experts. Product specifications do not expand or otherwise modify Vishay's terms and conditions of purchase, including but not limited to the warranty expressed therein.

Except as expressly indicated in writing, Vishay products are not designed for use in medical, life-saving, or life-sustaining applications or for any other application in which the failure of the Vishay product could result in personal injury or death. Customers using or selling Vishay products not expressly indicated for use in such applications do so at their own risk and agree to fully indemnify and hold Vishay and its distributors harmless from and against any and all claims, liabilities, expenses and damages arising or resulting in connection with such use or sale, including attorneys fees, even if such claim alleges that Vishay or its distributor was negligent regarding the design or manufacture of the part. Please contact authorized Vishay personnel to obtain written terms and conditions regarding products designed for such applications.

No license, express or implied, by estoppel or otherwise, to any intellectual property rights is granted by this document or by any conduct of Vishay. Product names and markings noted herein may be trademarks of their respective owners.

勝特力材料 886-3-5753170  
勝特力电子(上海) 86-21-34970699  
勝特力电子(深圳) 86-755-83298787  
[Http://www.100y.com.tw](http://www.100y.com.tw)