

High Performance Schottky Generation 5.0, 2 x 15 A

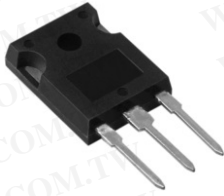

TO-247AC

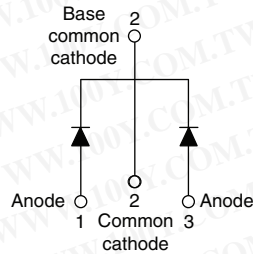

FEATURES

- 175 °C high performance Schottky diode
- Very low forward voltage drop
- Extremely low reverse leakage
- Optimized V_F vs. I_F trade off for high efficiency
- Increased ruggedness for reverse avalanche capability
- RBSOA available
- Negligible switching losses
- Submicron trench technology
- Full lead (Pb)-free and RoHS compliant devices
- Designed and qualified for industrial level



RoHS
COMPLIANT

PRODUCT SUMMARY

$I_{F(AV)}$	2 x 15 A
V_R	100 V
V_F at 15 A at 125 °C	0.67 V

APPLICATIONS

- High efficiency SMPS
- Automotive
- High frequency switching
- Output rectification
- Reverse battery protection
- Freewheeling
- Dc-to-dc systems
- Increased power density systems

MAJOR RATINGS AND CHARACTERISTICS

SYMBOL	CHARACTERISTICS	VALUES	UNITS
V_{RRM}		100	V
V_F	15 Apk, $T_J = 125$ °C (typical, per leg)	0.63	
T_J	Range	- 55 to 175	°C

VOLTAGE RATINGS

PARAMETER	SYMBOL	TEST CONDITIONS	30CPT100	UNITS
Maximum DC reverse voltage	V_R	$T_J = 25$ °C	100	V

ABSOLUTE MAXIMUM RATINGS

PARAMETER	SYMBOL	TEST CONDITIONS	VALUES	UNITS
Maximum average forward current	$I_{F(AV)}$	50 % duty cycle at $T_C = 158$ °C, rectangular waveform	15	A
			30	
Maximum peak one cycle non-repetitive surge current	I_{FSM}	5 μ s sine or 3 μ s rect. pulse	920	
		10 ms sine or 6 ms rect. pulse	240	
Non-repetitive avalanche energy	E_{AS}	$T_J = 25$ °C, $I_{AS} = 1.1$ A, L = 60 mH	36	mJ
Repetitive avalanche current	I_{AR}	Limited by frequency of operation and time pulse duration so that $T_J < T_J$ max. I_{AS} at T_J max. as a function of time pulse See fig. 8	I_{AS} at T_J max.	A

ELECTRICAL SPECIFICATIONS						
PARAMETER	SYMBOL	TEST CONDITIONS	TYP.	MAX.	UNITS	
Forward voltage drop per leg	$V_{FM}^{(1)}$	15 A	$T_J = 25\text{ }^\circ\text{C}$	-	0.81	V
		30 A		-	0.92	
		15 A	$T_J = 125\text{ }^\circ\text{C}$	-	0.67	
		30 A		-	0.79	
Reverse leakage current per leg	$I_{RM}^{(1)}$	$T_J = 25\text{ }^\circ\text{C}$	$V_R = \text{Rated } V_R$	-	120	μA
		$T_J = 125\text{ }^\circ\text{C}$		-	5	mA
Junction capacitance per leg	C_T	$V_R = 5\text{ }V_{DC}$ (test signal range 100 kHz to 1 MHz) 25 $^\circ\text{C}$	550	-	pF	
Series inductance per leg	L_S	Measured lead to lead 5 mm from package body	7.5	-	nH	
Maximum voltage rate of change	dV/dt	Rated V_R	-	10 000	V/ μs	

Note(1) Pulse width < 300 μs , duty cycle < 2 %

THERMAL - MECHANICAL SPECIFICATIONS				
PARAMETER	SYMBOL	TEST CONDITIONS	VALUES	UNITS
Maximum junction and storage temperature range	T_J, T_{Stg}		- 55 to 175	$^\circ\text{C}$
Maximum thermal resistance, junction to case per leg	R_{thJC}	DC operation	1.4	$^\circ\text{C/W}$
Maximum thermal resistance, junction to case per device			0.8	
Typical thermal resistance, case to heatsink	R_{thCS}	Mounting surface, smooth and greased	0.25	
Approximate weight			6	g
			0.21	oz.
Mounting torque	minimum		6 (5)	kgf · cm (lbf · in)
	maximum		12 (10)	
Marking device		Case style TO-247AC	30CPT100	



High Performance
Schottky Generation 5.0,
2 x 15 A

Vishay High Power Products

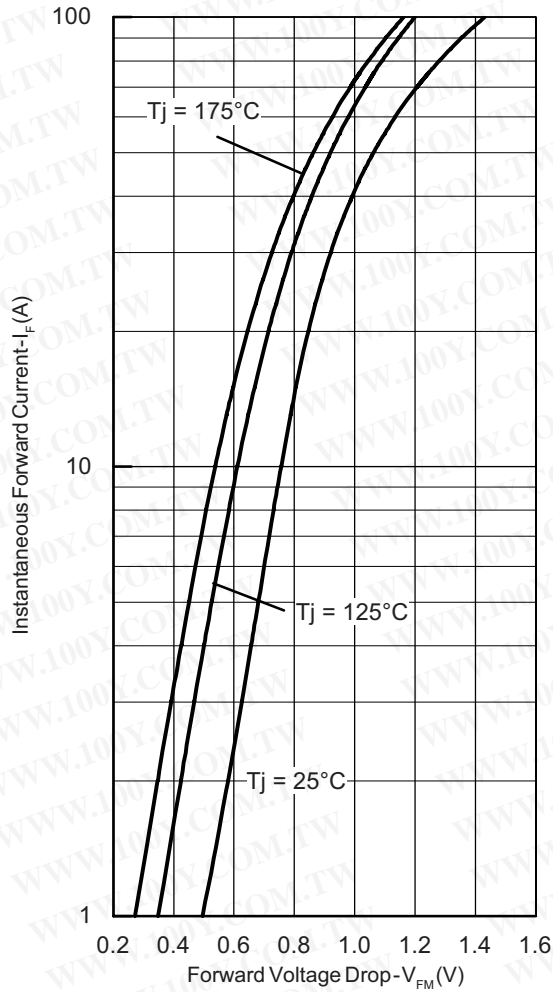

Fig. 1 - Maximum Forward Voltage Drop Characteristics

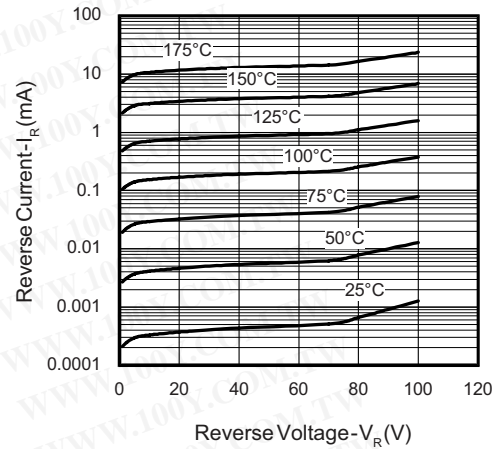

Fig. 2 - Typical Values of Reverse Current vs. Reverse Voltage

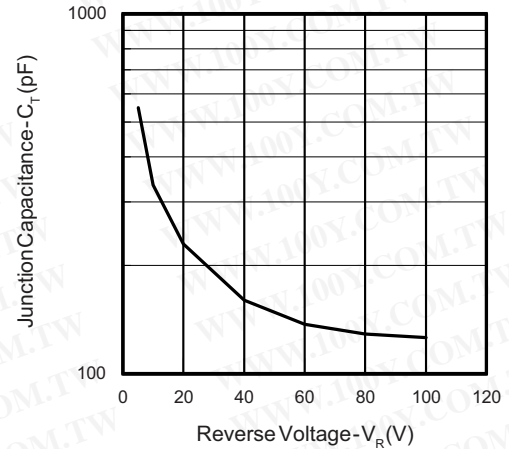

Fig. 3 - Typical Junction Capacitance vs. Reverse Voltage

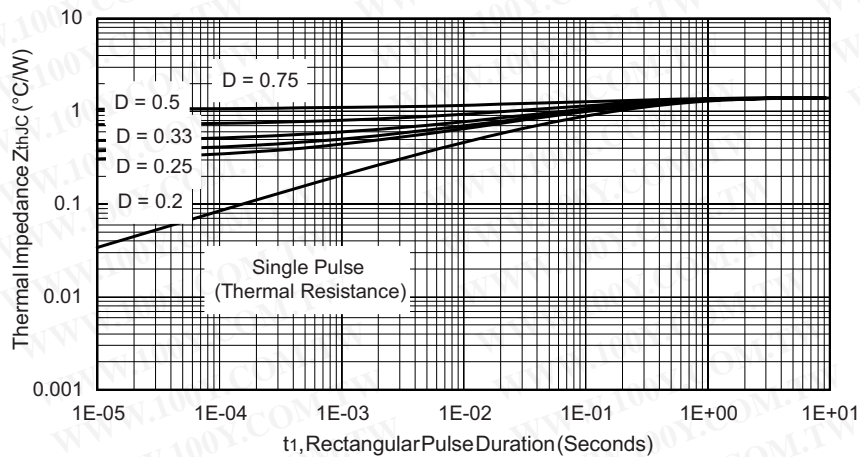

Fig. 4 - Maximum Thermal Impedance Z_{thJC} Characteristics

Vishay High Power Products High Performance
Schottky Generation 5.0,
2 x 15 A

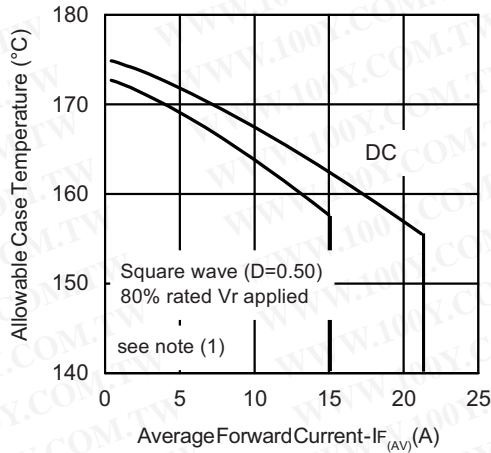

Fig. 5 - Maximum Allowable Case Temperature vs. Average Forward Current

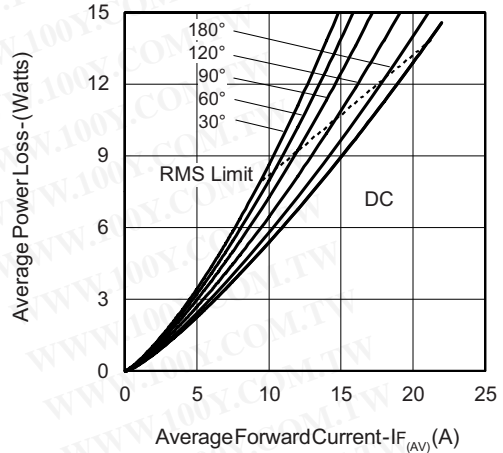

Fig. 6 - Forward Power Loss Characteristics

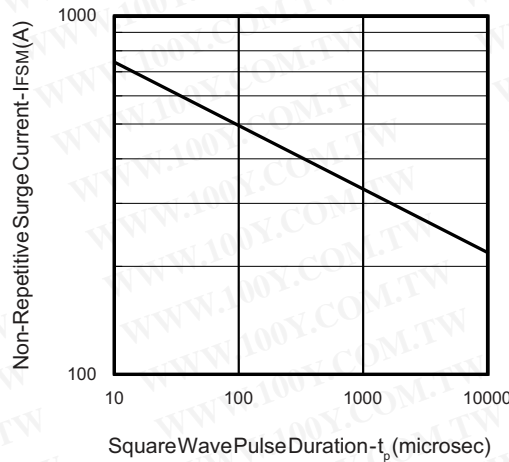

Fig. 7 - Maximum Non-Repetitive Surge Current

Note

- (1) Formula used: $T_C = T_J - (P_d + P_{d_{REV}}) \times R_{thJC}$;
 P_d = Forward power loss = $I_{F(AV)} \times V_{FM}$ at $(I_{F(AV)}/D)$ (see fig. 6);
 $P_{d_{REV}}$ = Inverse power loss = $V_{R1} \times I_R (1 - D)$; I_R at $V_{R1} = 80\%$ rated V_R



High Performance Vishay High Power Products
Schottky Generation 5.0,
2 x 15 A

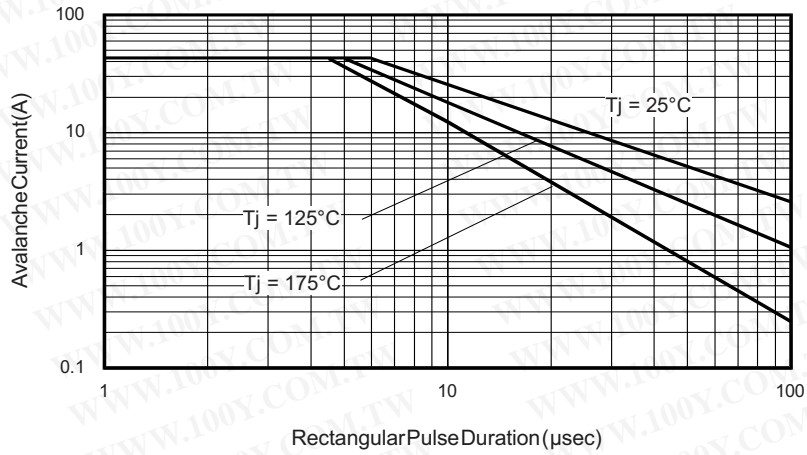

Fig. 8 - Reverse Bias Safe Operating Area (Avalanche Current vs. Rectangular Pulse Duration)

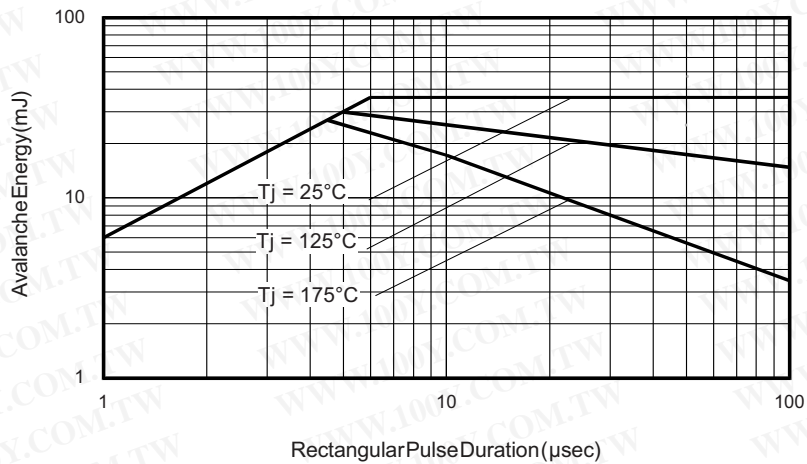

Fig. 9 - Reverse Bias Safe Operating Area (Avalanche Energy vs. Rectangular Pulse Duration)

30CPT100



Vishay High Power Products High Performance
Schottky Generation 5.0,
2 x 15 A

ORDERING INFORMATION TABLE

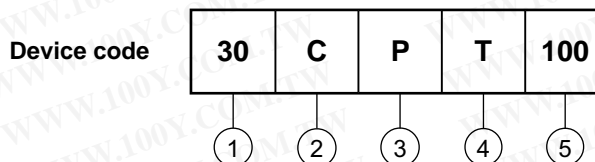

- 1** - Current rating (30 A)
- 2** - Circuit configuration:
C = Common cathode
- 3** - Package:
P = TO-247
- 4** - T = Trench
- 5** - Voltage code (100 V)

Tube standard pack quantity: 25 pieces

LINKS TO RELATED DOCUMENTS	
Dimensions	http://www.vishay.com/doc?95223
Part marking information	http://www.vishay.com/doc?95226



DIMENSIONS in millimeters and inches

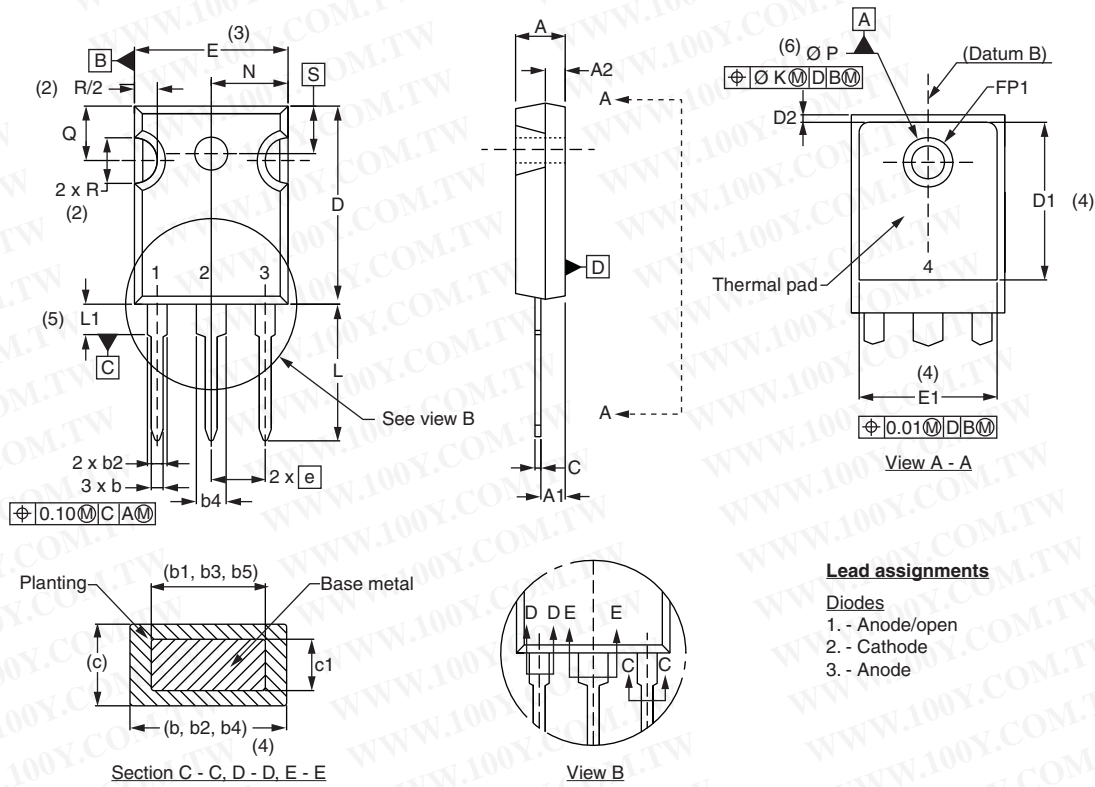

Lead assignments

- Diodes
 1. - Anode/open
 2. - Cathode
 3. - Anode

SYMBOL	MILLIMETERS		INCHES		NOTES
	MIN.	MAX.	MIN.	MAX.	
A	4.65	5.31	0.183	0.209	
A1	2.21	2.59	0.087	0.102	
A2	1.50	2.49	0.059	0.098	
b	0.99	1.40	0.039	0.055	
b1	0.99	1.35	0.039	0.053	
b2	1.65	2.39	0.065	0.094	
b3	1.65	2.37	0.065	0.094	
b4	2.59	3.43	0.102	0.135	
b5	2.59	3.38	0.102	0.133	
c	0.38	0.86	0.015	0.034	
c1	0.38	0.76	0.015	0.030	
D	19.71	20.70	0.776	0.815	3
D1	13.08	-	0.515	-	4
D2	0.51	1.30	0.020	0.051	
E	15.29	15.87	0.602	0.625	3
E1	13.72	-	0.540	-	
e	5.46 BSC		0.215 BSC		
FK	2.54		0.010		
L	14.20	16.10	0.559	0.634	
L1	3.71	4.29	0.146	0.169	
N	7.62 BSC		0.3		
ΦP	3.56	3.66	0.14	0.144	
$\Phi P1$	-	6.98	-	0.275	
Q	5.31	5.69	0.209	0.224	
R	4.52	5.49	1.78	0.216	
S	5.51 BSC		0.217 BSC		

Notes

- (1) Dimensioning and tolerancing per ASME Y14.5M-1994
- (2) Contour of slot optional
- (3) Dimension D and E do not include mold flash. Mold flash shall not exceed 0.127 mm (0.005") per side. These dimensions are measured at the outermost extremes of the plastic body
- (4) Thermal pad contour optional with dimensions D1 and E1
- (5) Lead finish uncontrolled in L1
- (6) ΦP to have a maximum draft angle of 1.5 to the top of the part with a maximum hole diameter of 3.91 mm (0.154")
- (7) Outline conforms to JEDEC outline TO-247 with exception of dimension c



勝特力材料 886-3-5753170
勝特力电子(上海) 86-21-34970699
勝特力电子(深圳) 86-755-83298787
Http://www.100y.com.tw

Disclaimer

ALL PRODUCT, PRODUCT SPECIFICATIONS AND DATA ARE SUBJECT TO CHANGE WITHOUT NOTICE TO IMPROVE RELIABILITY, FUNCTION OR DESIGN OR OTHERWISE.

Vishay Intertechnology, Inc., its affiliates, agents, and employees, and all persons acting on its or their behalf (collectively, "Vishay"), disclaim any and all liability for any errors, inaccuracies or incompleteness contained in any datasheet or in any other disclosure relating to any product.

Vishay makes no warranty, representation or guarantee regarding the suitability of the products for any particular purpose or the continuing production of any product. To the maximum extent permitted by applicable law, Vishay disclaims (i) any and all liability arising out of the application or use of any product, (ii) any and all liability, including without limitation special, consequential or incidental damages, and (iii) any and all implied warranties, including warranties of fitness for particular purpose, non-infringement and merchantability.

Statements regarding the suitability of products for certain types of applications are based on Vishay's knowledge of typical requirements that are often placed on Vishay products in generic applications. Such statements are not binding statements about the suitability of products for a particular application. It is the customer's responsibility to validate that a particular product with the properties described in the product specification is suitable for use in a particular application. Parameters provided in datasheets and/or specifications may vary in different applications and performance may vary over time. All operating parameters, including typical parameters, must be validated for each customer application by the customer's technical experts. Product specifications do not expand or otherwise modify Vishay's terms and conditions of purchase, including but not limited to the warranty expressed therein.

Except as expressly indicated in writing, Vishay products are not designed for use in medical, life-saving, or life-sustaining applications or for any other application in which the failure of the Vishay product could result in personal injury or death. Customers using or selling Vishay products not expressly indicated for use in such applications do so at their own risk and agree to fully indemnify and hold Vishay and its distributors harmless from and against any and all claims, liabilities, expenses and damages arising or resulting in connection with such use or sale, including attorneys fees, even if such claim alleges that Vishay or its distributor was negligent regarding the design or manufacture of the part. Please contact authorized Vishay personnel to obtain written terms and conditions regarding products designed for such applications.

No license, express or implied, by estoppel or otherwise, to any intellectual property rights is granted by this document or by any conduct of Vishay. Product names and markings noted herein may be trademarks of their respective owners.

Material Category Policy

Vishay Intertechnology, Inc. hereby certifies that all its products that are identified as RoHS-Compliant fulfill the definitions and restrictions defined under Directive 2011/65/EU of The European Parliament and of the Council of June 8, 2011 on the restriction of the use of certain hazardous substances in electrical and electronic equipment (EEE) - recast, unless otherwise specified as non-compliant.

Please note that some Vishay documentation may still make reference to RoHS Directive 2002/95/EC. We confirm that all the products identified as being compliant to Directive 2002/95/EC conform to Directive 2011/65/EU.