

TPSMF4L Series

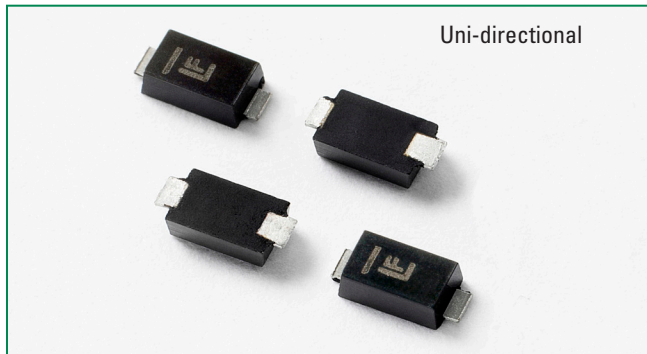

| Agency Approvals | |
|------------------|--------------------|
| AGENCY | AGENCY FILE NUMBER |
| | E230531 |

Maximum Ratings and Thermal Characteristics (T_A=25°C unless otherwise noted)

| Parameter | Symbol | Value | Unit |
|---|-----------------------------------|------------|------|
| Peak Pulse Power Dissipation at T _A =25°C (Note 1) | 8/20 (Note 2) | 2000 | W |
| | 10/1000µs (Note 3) | 400 | W |
| Thermal Resistance Junction to Ambient | R _{θJA} | 220 | °C/W |
| Thermal Resistance Junction to Lead | R _{θJL} | 100 | °C/W |
| Operating and Storage Temperature Range | T _J , T _{STG} | -55 to 150 | °C |

- Notes:**
- Non-repetitive current pulse, per Fig. 4 and derated above T_J (initial) =25°C per Fig. 3.
 - TPSMF4L5.0A~TPSMF4L9.0A Peak Pulse Power Dissipation is 1850W min, 2000W typical @8/20us
 - TPSMF4L5.0A~TPSMF4L9.0A Peak Pulse Power Dissipation is 370W min, 400W typical @10/1000µs

Functional Diagram

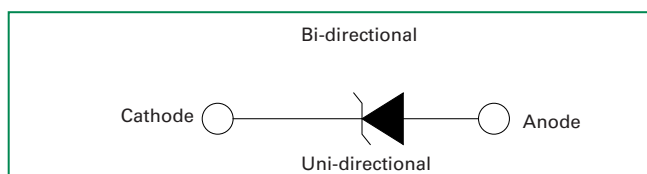

Description

The TPSMF4L series of SOD-123FL small and flat lead low-profile plastic package is designed specifically to protect sensitive electronic equipment from voltage transients induced by lightning and other transient voltage events, and it's especially suitable for high reliability and automotive application.

Features

- Hi reliability application and automotive grade AEC Q101 qualified
- 400W peak pulsepower capability at 10/1000µs waveform, repetition rate (duty cycle): 0.01%
- Compatible with industrial standard package SOD-123FL
- Low inductance, excellent clamping capability
- For surface mounted applications to optimize board space
- Typical failure mode is short from over-specified voltage or current
- Whisker test is conducted based on JEDEC JESD201A per its table 4a and 4c
- IEC-61000-4-2 ESD 30kV(Air), 30kV (Contact)
- ESD protection of data lines in accordance with IEC 61000-4-2
- EFT protection of data lines in accordance with IEC 61000-4-4
- Fast response time: typically less than 1.0ns from 0 Volts to V_{BR} min
- High temperature soldering: 260°C/40 seconds at terminals
- Glass passivated junction
- Built-in strain relief
- Plastic package is flammability rated V-0 per Underwriters Laboratories
- Meet MSL level1, per J-STD-020, LF maximum peak of 260°C
- Matte tin lead-free plated
- Halogen-free and RoHS compliant
- Pb-free E3 means 2nd level interconnect is Pb-free and the terminal finish material is tin(Sn) (IPC/JEDEC J-STD-609A.01)

Applications

TPSMF4L devices are ideal for the protection of portable devices/hard drives, notebooks, V_{CC} busses, POS terminal, SSDs, power supplies, monitors, and vulnerable circuit used in other consumer applications.

勝特力電材超市-龍山店 886-3-5773766
 勝特力電材超市-光復店 886-3-5729570
 勝特力电子(上海) 86-21-34970699
 勝特力电子(深圳) 86-755-83298787
<http://www.100y.com.tw>

Electrical Characteristics ($T_A=25^\circ\text{C}$ unless otherwise noted)

| Part Number | Marking Code | Breakdown Voltage V_{BR} (Volts) @ I_T | | Test Current I_T (mA) | Reverse Stand off Voltage V_R (V) | Maximum Reverse Leakage @ V_R I_R (μA) | Maximum Peak Pulse Current I_{pp} (A) | Maximum Clamping Voltage @ I_{pp} V_C (V) | Agency Approval  |
|-------------|--------------|--|--------|-------------------------|-------------------------------------|---|---|---|---|
| | | MIN | MAX | | | | | | |
| TPSMF4L5.0A | KEA | 6.40 | 7.00 | 10 | 5.0 | 800 | 40.1 | 9.2 | X |
| TPSMF4L6.0A | KGA | 6.67 | 7.37 | 10 | 6.0 | 800 | 35.9 | 10.3 | X |
| TPSMF4L6.5A | KKA | 7.22 | 7.98 | 10 | 6.5 | 500 | 33.1 | 11.2 | X |
| TPSMF4L7.0A | KMA | 7.78 | 8.60 | 10 | 7.0 | 200 | 30.9 | 12.0 | X |
| TPSMF4L7.5A | KPA | 8.33 | 9.21 | 1 | 7.5 | 100 | 28.7 | 12.9 | X |
| TPSMF4L8.0A | KRA | 8.89 | 9.83 | 1 | 8.0 | 50 | 27.2 | 13.6 | X |
| TPSMF4L8.5A | KTA | 9.44 | 10.40 | 1 | 8.5 | 20 | 25.7 | 14.4 | X |
| TPSMF4L9.0A | KVA | 10.00 | 11.10 | 1 | 9.0 | 10 | 24.1 | 15.4 | X |
| TPSMF4L10A | KXA | 11.10 | 12.30 | 1 | 10 | 5 | 23.5 | 17.0 | X |
| TPSMF4L11A | KZA | 12.20 | 13.50 | 1 | 11 | 1 | 22.0 | 18.2 | X |
| TPSMF4L12A | LEA | 13.30 | 14.70 | 1 | 12 | 1 | 20.1 | 19.9 | X |
| TPSMF4L13A | LGA | 14.40 | 15.90 | 1 | 13 | 1 | 18.6 | 21.5 | X |
| TPSMF4L14A | LKA | 15.60 | 17.20 | 1 | 14 | 1 | 17.2 | 23.2 | X |
| TPSMF4L15A | LMA | 16.70 | 18.50 | 1 | 15 | 1 | 16.4 | 24.4 | X |
| TPSMF4L16A | LPA | 17.80 | 19.70 | 1 | 16 | 1 | 15.4 | 26.0 | X |
| TPSMF4L17A | LRA | 18.90 | 20.90 | 1 | 17 | 1 | 14.5 | 27.6 | X |
| TPSMF4L18A | LTA | 20.00 | 22.10 | 1 | 18 | 1 | 13.7 | 29.2 | X |
| TPSMF4L20A | LVA | 22.20 | 24.50 | 1 | 20 | 1 | 12.3 | 32.4 | X |
| TPSMF4L22A | LXA | 24.40 | 26.90 | 1 | 22 | 1 | 11.3 | 35.5 | X |
| TPSMF4L24A | LZA | 26.70 | 29.50 | 1 | 24 | 1 | 10.3 | 38.9 | X |
| TPSMF4L26A | MEA | 28.90 | 31.90 | 1 | 26 | 1 | 9.5 | 42.1 | X |
| TPSMF4L28A | MGA | 31.10 | 34.40 | 1 | 28 | 1 | 8.8 | 45.4 | X |
| TPSMF4L30A | MKA | 33.30 | 36.80 | 1 | 30 | 1 | 8.3 | 48.4 | X |
| TPSMF4L33A | MMA | 36.70 | 40.60 | 1 | 33 | 1 | 7.5 | 53.3 | X |
| TPSMF4L36A | MPA | 40.00 | 44.20 | 1 | 36 | 1 | 6.9 | 58.1 | X |
| TPSMF4L40A | MRA | 44.40 | 49.10 | 1 | 40 | 1 | 6.2 | 64.5 | X |
| TPSMF4L43A | MTA | 47.80 | 52.80 | 1 | 43 | 1 | 5.8 | 69.4 | X |
| TPSMF4L45A | MVA | 50.00 | 55.30 | 1 | 45 | 1 | 5.5 | 72.7 | X |
| TPSMF4L48A | MXA | 53.30 | 58.90 | 1 | 48 | 1 | 5.2 | 77.4 | X |
| TPSMF4L51A | MZA | 56.70 | 62.70 | 1 | 51 | 1 | 4.9 | 82.4 | X |
| TPSMF4L54A | NEA | 60.00 | 66.30 | 1 | 54 | 1 | 4.6 | 87.1 | X |
| TPSMF4L58A | NGA | 64.40 | 71.20 | 1 | 58 | 1 | 4.3 | 93.6 | X |
| TPSMF4L60A | NKA | 66.70 | 73.70 | 1 | 60 | 1 | 4.1 | 96.8 | X |
| TPSMF4L64A | NMA | 71.10 | 78.60 | 1 | 64 | 1 | 3.9 | 103.0 | X |
| TPSMF4L70A | NPA | 77.80 | 86.00 | 1 | 70 | 1 | 3.5 | 113.0 | X |
| TPSMF4L75A | NRA | 83.30 | 92.10 | 1 | 75 | 1 | 3.3 | 121.0 | X |
| TPSMF4L78A | NTA | 86.70 | 95.80 | 1 | 78 | 1 | 3.2 | 126.0 | X |
| TPSMF4L85A | NVA | 94.40 | 104.00 | 1 | 85 | 1 | 2.9 | 137.0 | X |

Notes:

- V_{BR} measured after I_T applied for 300 μs , I_T = square wave pulse or equivalent.
- Surge current waveform per 10/1000 μs exponential wave and derated per Fig.2.
- All terms and symbols are consistent with ANSI/IEEE C62.35.

I-V Curve Characteristics

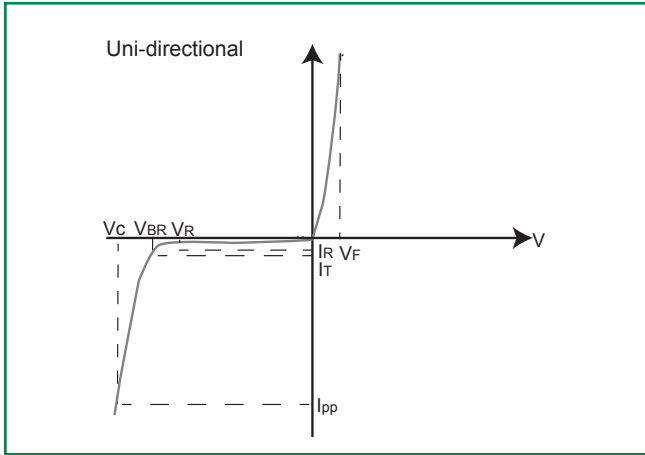

- P_{PPM} Peak Pulse Power Dissipation** – Max power dissipation
- V_R Stand-off Voltage** – Maximum voltage that can be applied to the TVS without operation
- V_{BR} Breakdown Voltage** – Maximum voltage that flows through the TVS at a specified test current (I_T)
- V_C Clamping Voltage** – Peak voltage measured across the TVS at a specified I_{ppm} (peak impulse current)
- I_R Reverse Leakage Current** – Current measured at V_R
- V_F Forward Voltage Drop for Uni-directional**

Ratings and Characteristic Curves ($T_A=25^\circ\text{C}$ unless otherwise noted)

Figure 1 - TVS Transients Clamping Waveform

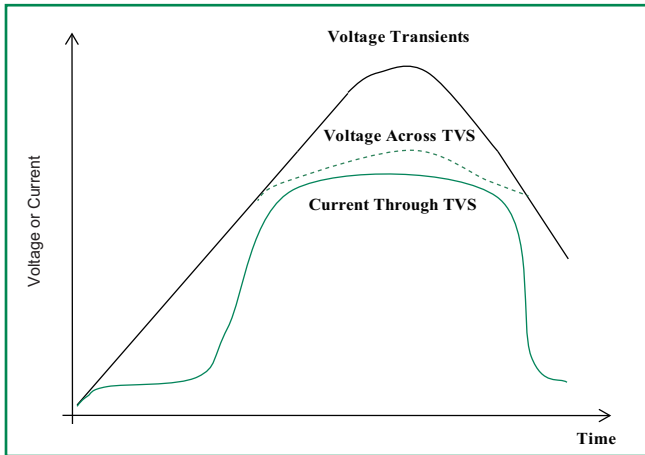
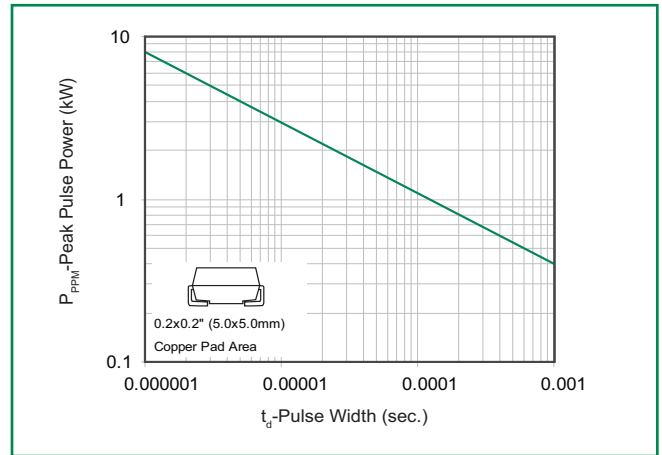

Figure 2 - Peak Pulse Power Rating Curve



continues on next page.

Ratings and Characteristic Curves ($T_A=25^\circ\text{C}$ unless otherwise noted) (Continued)

Figure 3 - Peak Pulse Power Derating Curve

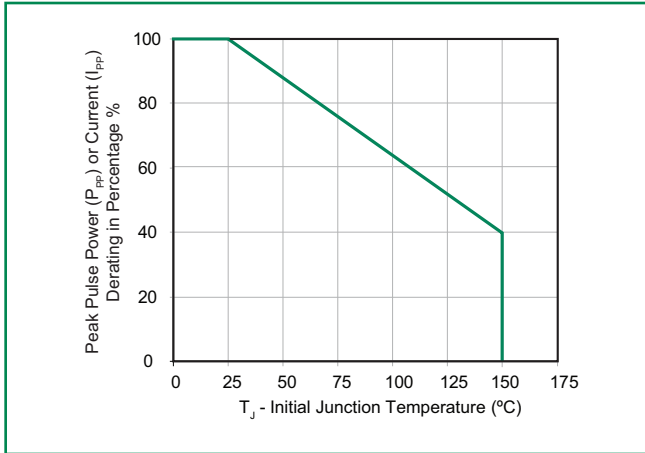

Figure 4 - Pulse Waveform - 10/1000 μ S

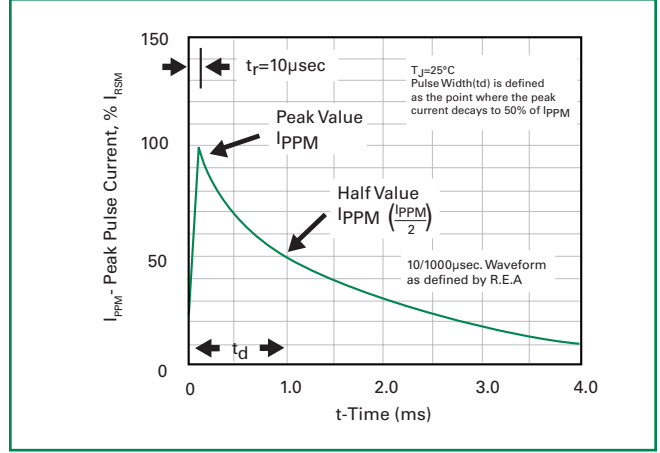

Figure 5 - Forward Voltage

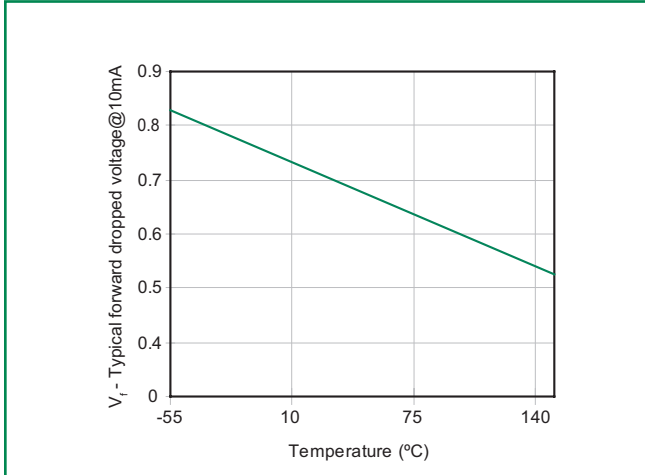

Figure 6 - Typical Junction Capacitance

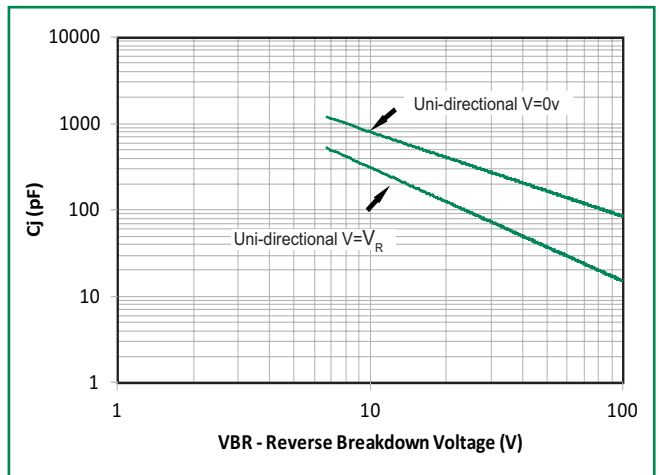

Figure 7 - Peak Forward Voltage Drop vs. Peak Forward Current

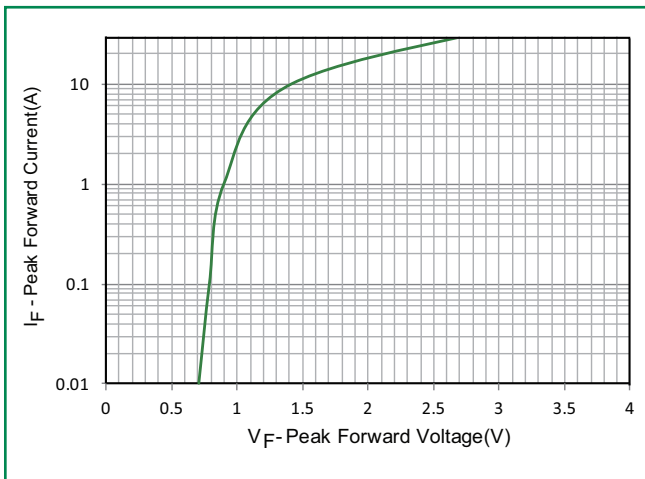
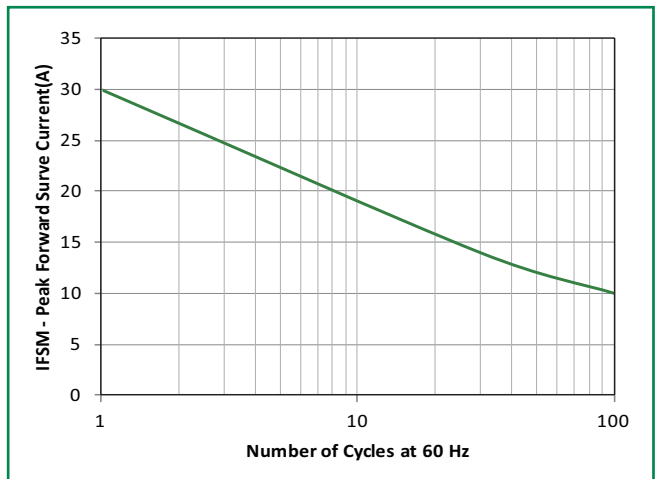
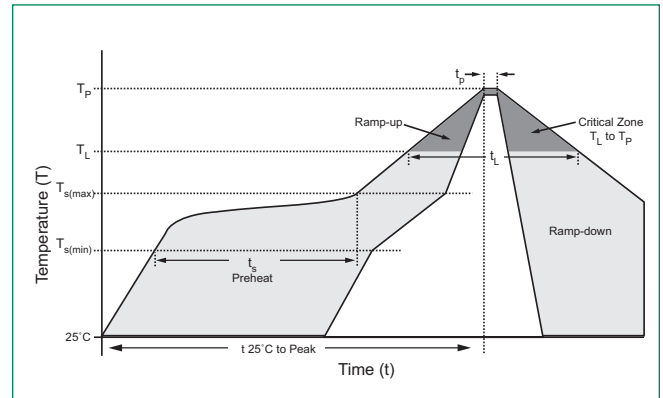

Figure 8 - Maximum Non-Repetitive Forward Surge Current Uni-Directional Only



Soldering Parameters

| | | |
|--|------------------------------------|-------------------------|
| Reflow Condition | | Lead-free assembly |
| Pre Heat | - Temperature Min ($T_{s(min)}$) | 150°C |
| | - Temperature Max ($T_{s(max)}$) | 200°C |
| | - Time (min to max) (t_s) | 60 – 180 secs |
| Average ramp up rate (Liquidus Temp (T_A) to peak) | | 3°C/second max |
| $T_{s(max)}$ to T_A - Ramp-up Rate | | 3°C/second max |
| Reflow | - Temperature (T_A) (Liquidus) | 217°C |
| | - Time (min to max) (t_s) | 60 – 150 seconds |
| Peak Temperature (T_p) | | 260 ^{+0/-5} °C |
| Time within 5°C of actual peak Temperature (t_p) | | 20 – 40 seconds |
| Ramp-down Rate | | 6°C/second max |
| Time 25°C to peak Temperature (T_p) | | 8 minutes Max. |
| Do not exceed | | 260°C |



Physical Specifications

| | |
|-----------------|--|
| Case | SOD-123FL plastic over glass passivated junction |
| Polarity | Color band denotes cathode except bipolar |
| Terminal | Matte tin-plated leads, solderable per JESD22-B102 |

Environmental Specifications

| | |
|----------------------------|--------------------------|
| High Temp. Storage | JESD22-A103 |
| HTRB | JESD22-A108 |
| Temperature Cycling | JESD22-A104 |
| MSL | JEDEC-J-STD-020, Level 1 |
| H3TRB | JESD22-A101 |
| RSH | JESD22-A111 |

Dimensions - SOD-123FL Package

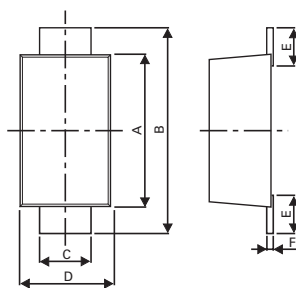

Mounting Pad Layout

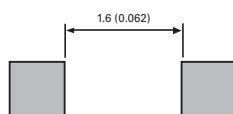

| Dimensions | Millimeters | | Inches | |
|------------|-------------|------|--------|-------|
| | Min | Max | Min | Max |
| A | 2.90 | 3.10 | 0.114 | 0.122 |
| B | 3.50 | 3.90 | 0.138 | 0.154 |
| C | 0.85 | 1.05 | 0.033 | 0.041 |
| D | 1.70 | 2.00 | 0.067 | 0.079 |
| E | 0.43 | 0.83 | 0.017 | 0.033 |
| F | 0.10 | 0.25 | 0.004 | 0.010 |
| G | 0.00 | 0.10 | 0.000 | 0.004 |
| H | 0.90 | 1.08 | 0.035 | 0.043 |

Part Numbering System

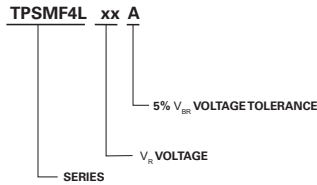

Part Marking System

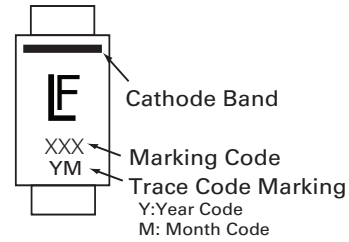

Packaging Options

| Part number | Component Package | Quantity | Packaging Option | Packaging Specification |
|-------------|-------------------|----------|--------------------------------|-------------------------|
| TPSMF4LXXX | SOD-123FL | 3000 | Tape & Reel – 8mm tape/7" reel | EIA RS-481 |

Tape and Reel Specification

