



STGB6NC60HD - STGB6NC60HD-1 STGF6NC60HD - STGP6NC60HD

N-channel 600V - 7A - I²PAK / D²PAK / TO-220 / TO-220FP
 Very fast PowerMESH™ IGBT

Features

Type	V _{CE}	V _{CE(sat)} max @25°C	I _C @100°C
STGB6NC60HD	600V	<2.5V	7A
STGB6NC60HD-1	600V	<2.5V	7A
STGP6NC60HD	600V	<2.5V	7A
STGF6NC60HD	600V	<2.5V	3A

- Low on voltage drop (V_{cesat})
- Low C_{RES} / C_{IES} ratio (no cross-conduction susceptibility)
- Very soft ultra fast recovery antiparallel diode
- High frequency operation

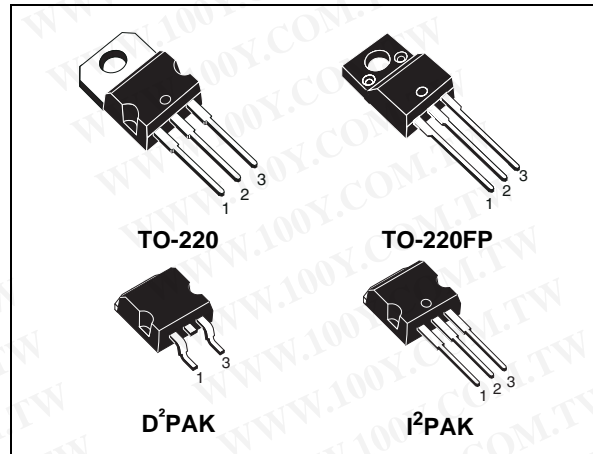

Description

Using the latest high voltage technology based on a patented strip layout, STMicroelectronics has designed an advanced family of IGBTs, the PowerMESH™ IGBTs, with outstanding performances. The suffix “H” identifies a family optimized for high frequency application in order to achieve very high switching performances (reduced t_{fall}) maintaining a low voltage drop.

Applications

- High frequency inverters
- SMPS and PFC in both hard switch and resonant topologies
- Motor drivers

Internal schematic diagram

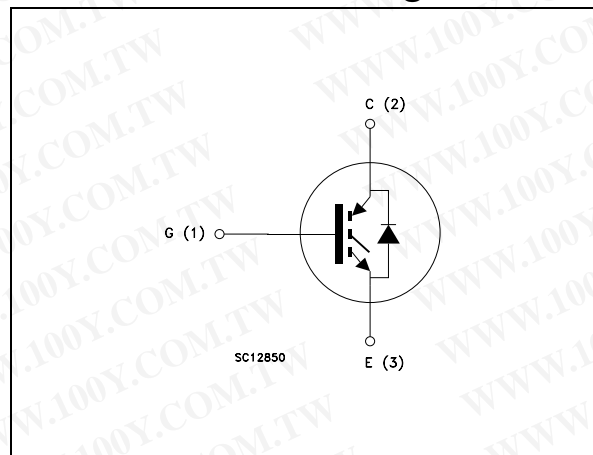

Order codes

Part number	Marking	Package	Packaging
STGB6NC60HDT4	GB6NC60HD	D ² PAK	Tape & reel
STGB6NC60HD-1	GB6NC60HD	I ² PAK	Tube
STGP6NC60HD	GP6NC60HD	TO-220	Tube
STGF6NC60HD	GF6NC60HD	TO-220FP	Tube

Contents

1	Electrical ratings	3
2	Electrical characteristics	4
2.1	Electrical characteristics (curves)	7
3	Test circuit	10
4	Package mechanical data	11
5	Packaging mechanical data	16
6	Revision history	17

1 Electrical ratings

Table 1. Absolute maximum ratings

Symbol	Parameter	Value		Unit
		D ² PAK/I ² PAK/ TO-220	TO-220FP	
V _{CES}	Collector-emitter voltage (V _{GS} = 0)	600		V
I _C ⁽¹⁾	Collector current (continuous) at T _C = 25°C	15	6	A
I _C ⁽¹⁾	Collector current (continuous) at T _C = 100°C	7	3	A
I _{CM} ⁽²⁾	Collector current (pulsed)	21		A
V _{GE}	Gate-emitter voltage	±20		V
I _F	Diode RMS forward current at T _C =25°C	10		A
P _{TOT}	Total dissipation at T _C = 25°C	56	20	W
V _{ISO}	Insulation withstand voltage A.C.(t=1sec;T _C =25°C)	--	2500	
T _{stg}	Storage temperature	- 55 to 150		°C
T _J	Operating junction temperature			
T _I	Maximum lead temperature for soldering purpose (for 10sec. 1.6 mm from case)	300		°C

1. Calculated according to the iterative formula::

$$I_C(T_C) = \frac{T_{JMAX} - T_C}{R_{THJ-C} \times V_{CESAT(MAX)}(T_C, I_C)}$$

2. Pulse width limited by max junction temperature

Table 2. Thermal resistance

Symbol	Parameter		Value	Unit
R _{thj-case}	Thermal resistance junction-case max	TO-220 D ² PAK I ² PAK	2	°C/W
		TO-220FP	5	°C/W
R _{thj-amb}	Thermal resistance junction-ambient max		62.5	°C/W

2 Electrical characteristics

($T_{CASE}=25^{\circ}\text{C}$ unless otherwise specified)

Table 3. Static

Symbol	Parameter	Test conditions	Min.	Typ.	Max.	Unit
$V_{BR(CES)}$	Collector-emitter breakdown voltage	$I_C = 1\text{mA}, V_{GE} = 0$	600			V
$V_{CE(sat)}$	Collector-emitter saturation voltage	$V_{GE} = 15\text{V}, I_C = 3\text{A}$ $V_{GE} = 15\text{V}, I_C = 3\text{A}, T_C = 125^{\circ}\text{C}$		1.9 1.7	2.5	V V
$V_{GE(th)}$	Gate threshold voltage	$V_{CE} = V_{GE}, I_C = 250\ \mu\text{A}$	3.75		5.75	V
I_{CES}	Collector cut-off current ($V_{GE} = 0$)	$V_{CE} = \text{Max rating}, T_C = 25^{\circ}\text{C}$ $V_{CE} = \text{Max rating}, T_C = 125^{\circ}\text{C}$			10 1	μA mA
I_{GES}	Gate-emitter leakage current ($V_{CE} = 0$)	$V_{GE} = \pm 20\text{V}, V_{CE} = 0$			± 100	nA
g_{fs}	Forward transconductance	$V_{CE} = 15\text{V}, I_C = 3\text{A}$		3		S

Table 4. Dynamic

Symbol	Parameter	Test conditions	Min.	Typ.	Max.	Unit
C_{ies}	Input capacitance	$V_{CE} = 25\text{V}, f = 1\text{MHz},$ $V_{GE} = 0$		205		pF
C_{oes}	Output capacitance			32		pF
C_{res}	Reverse transfer capacitance			5.5		pF
Q_g	Total gate charge	$V_{CE} = 390\text{V}, I_C = 3\text{A},$ $V_{GE} = 15\text{V},$ <i>(see Figure 18)</i>		13.6		nC
Q_{ge}	Gate-emitter charge			3.4		nC
Q_{gc}	Gate-collector charge			5.1		nC
I_{CL}	Turn-off SOA minimum current	$V_{clamp} = 390\text{V}, T_J = 150^{\circ}\text{C},$ $R_G = 10\ \Omega, V_{GE} = 15\text{V}$		19		A

Table 5. Switching on/off (inductive load)

Symbol	Parameter	Test conditions	Min.	Typ.	Max.	Unit
$t_{d(on)}$	Turn-on delay time	$V_{CC} = 390V, I_C = 3A$		12		ns
t_r	Current rise time	$R_G = 10\Omega, V_{GE} = 15V,$		5		ns
$(di/dt)_{on}$	Turn-on current slope	$T_j = 25^\circ C$ (see Figure 19)		612		A/ μs
$t_{d(on)}$	Turn-on delay time	$V_{CC} = 390V, I_C = 3A$		13		ns
t_r	Current rise time	$R_G = 10\Omega, V_{GE} = 15V,$		4.3		ns
$(di/dt)_{on}$	Turn-on current slope	$T_j = 125^\circ C$ (see Figure 19)		560		A/ μs
$t_r(V_{off})$	Off voltage rise time	$V_{CC} = 390V, I_C = 3A,$		40		ns
$t_{d(off)}$	Turn-off delay time	$R_{GE} = 10\Omega, V_{GE} = 15V,$		76		ns
t_f	Current fall time	$T_j = 25^\circ C$ (see Figure 19)		100		ns
$t_r(V_{off})$	Off voltage rise time	$V_{CC} = 390V, I_C = 3A,$		60		ns
$t_{d(off)}$	Turn-off delay time	$R_{GE} = 10\Omega, V_{GE} = 15V,$		98		ns
t_f	Current fall time	$T_j = 125^\circ C$ (see Figure 19)		124		ns

Table 6. Switching energy (inductive load)

Symbol	Parameter	Test conditions	Min.	Typ.	Max.	Unit
$E_{on}^{(1)}$	Turn-on switching losses	$V_{CC} = 390V, I_C = 3A$		20		μJ
$E_{off}^{(2)}$	Turn-off switching losses	$R_G = 10\Omega, V_{GE} = 15V,$		68		μJ
E_{ts}	Total switching losses	$T_j = 25^\circ C$ (see Figure 19)		88		μJ
$E_{on}^{(1)}$	Turn-on switching losses	$V_{CC} = 390V, I_C = 3A$		37		μJ
$E_{off}^{(2)}$	Turn-off switching losses	$R_G = 10\Omega, V_{GE} = 15V,$		93		μJ
E_{ts}	Total switching losses	$T_j = 125^\circ C$ (see Figure 19)		130		μJ

1. E_{on} is the turn-on losses when a typical diode is used in the test circuit in figure 17. If the IGBT is offered in a package with a co-pack diode, the co-pack diode is used as external diode. IGBTs & Diode are at the same temperature (25°C and 125°C)

2. Turn-off losses include also the tail of the collector current

Table 7. Collector-emitter diode

Symbol	Parameter	Test conditions	Min.	Typ.	Max.	Unit
V_f	Forward on-voltage	$I_f = 1.5A$ $I_f = 1.5A, T_j = 125^\circ C$		1.6 1.3	2.1	V V
t_{rr}	Reverse recovery time	$I_f = 3A, V_R = 40V,$ $T_j = 25^\circ C, di/dt = 100 A/\mu s$		21		ns
Q_{rr}	Reverse recovery charge	$T_j = 25^\circ C, di/dt = 100 A/\mu s$ (see Figure 20)		14		nC
I_{rrm}	Reverse recovery current	(see Figure 20)		1.36		A
t_{rr}	Reverse recovery time	$I_f = 3A, V_R = 40V,$ $T_j = 125^\circ C, di/dt = 100A/\mu s$		34		ns
Q_{rr}	Reverse recovery charge	$T_j = 125^\circ C, di/dt = 100A/\mu s$ (see Figure 20)		32		nC
I_{rrm}	Reverse recovery current	(see Figure 20)		1.88		A

2.1 Electrical characteristics (curves)

Figure 1. Output characteristics

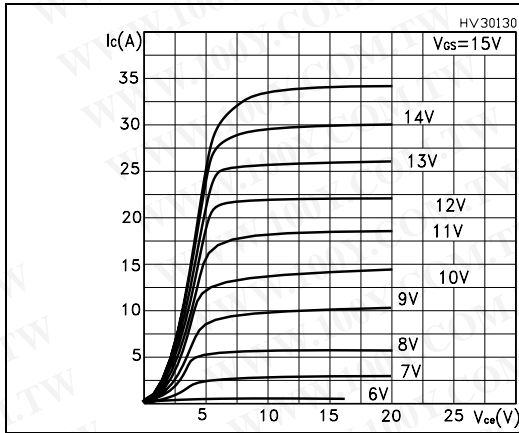

Figure 2. Transfer characteristics

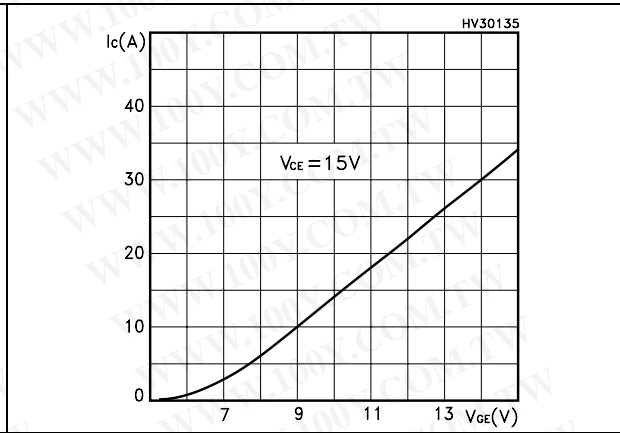

Figure 3. Transconductance

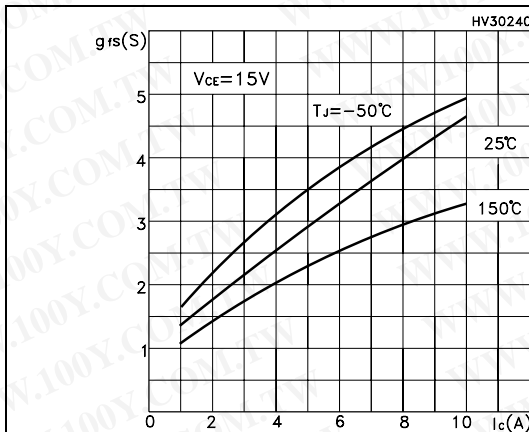

Figure 4. Collector-emitter on voltage vs temperature

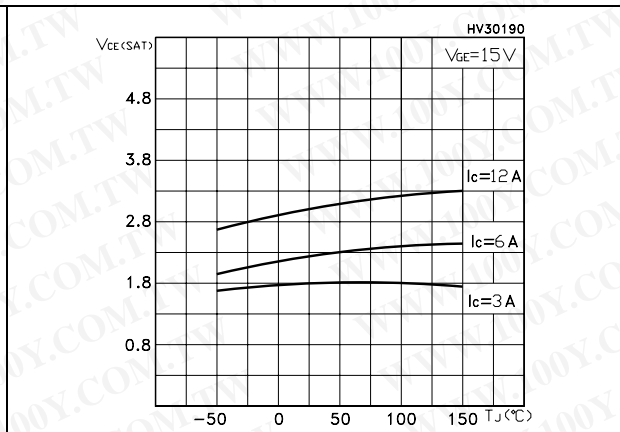

Figure 5. Gate charge vs gate-source voltage

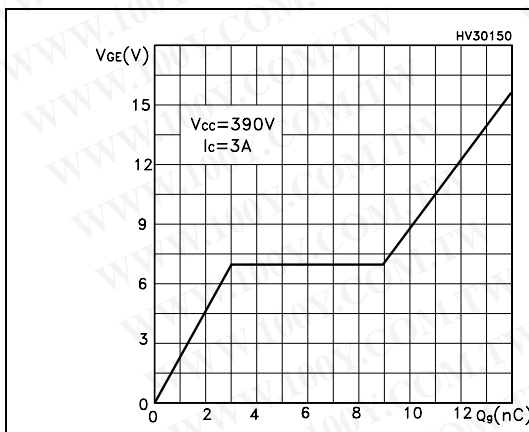

Figure 6. Capacitance variations

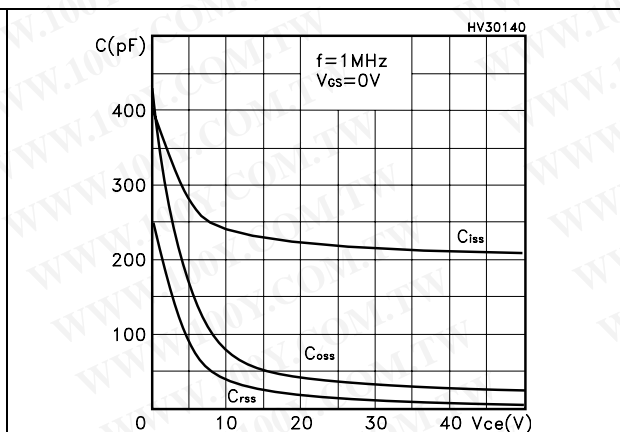

Figure 7. Normalized gate threshold voltage vs temperature

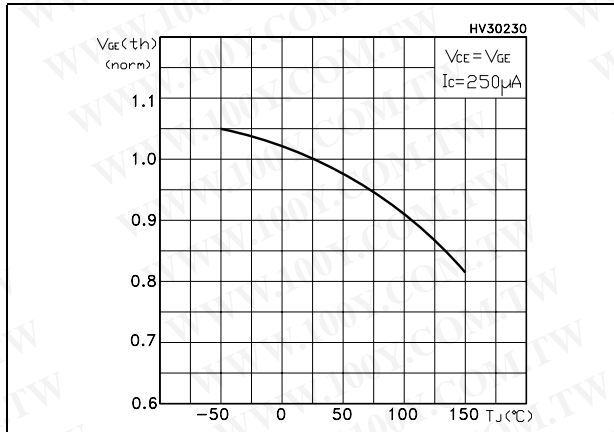

Figure 8. Collector-emitter on voltage vs collector current

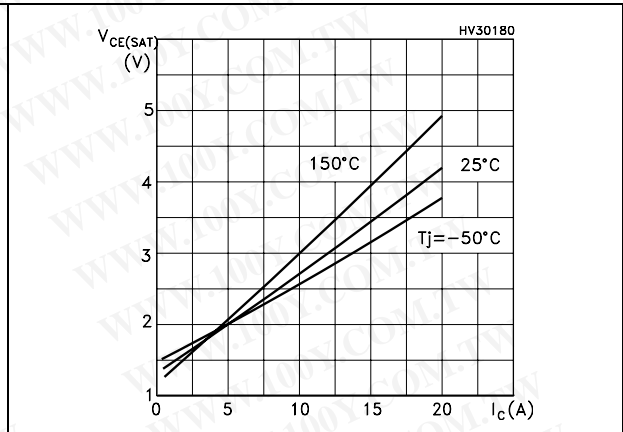

Figure 9. Normalized breakdown voltage vs temperature

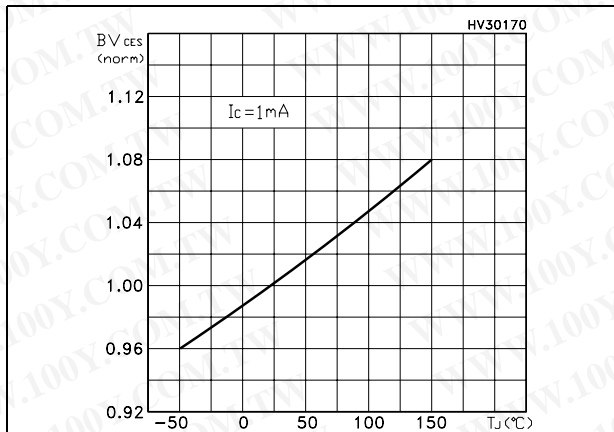

Figure 10. Switching losses vs temperature

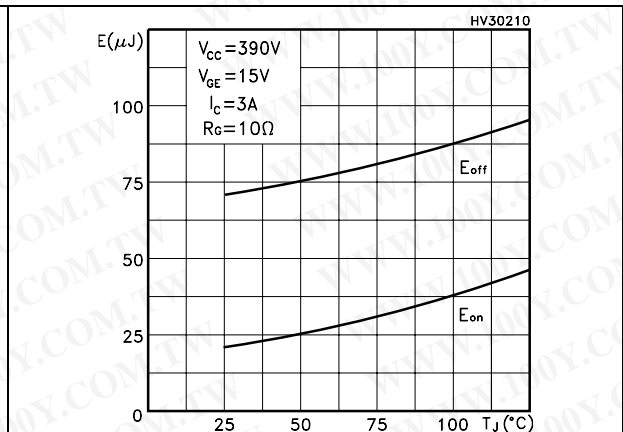

Figure 11. Switching losses vs gate resistance

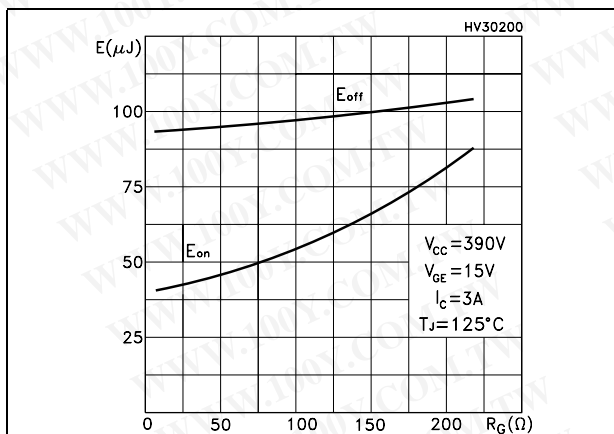

Figure 12. Switching losses vs collector current

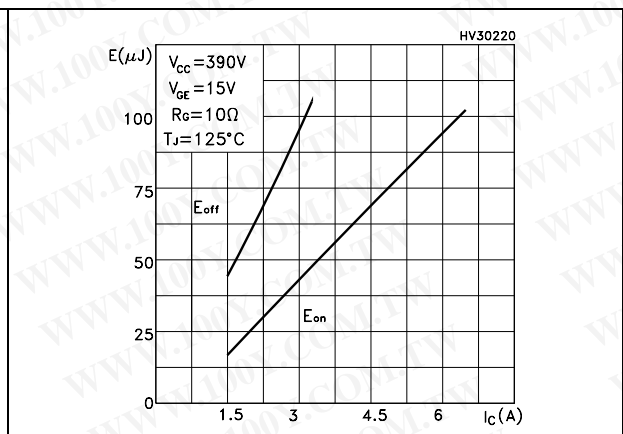

Figure 13. Thermal impedance for TO-220 / D²PAK / I²PAK

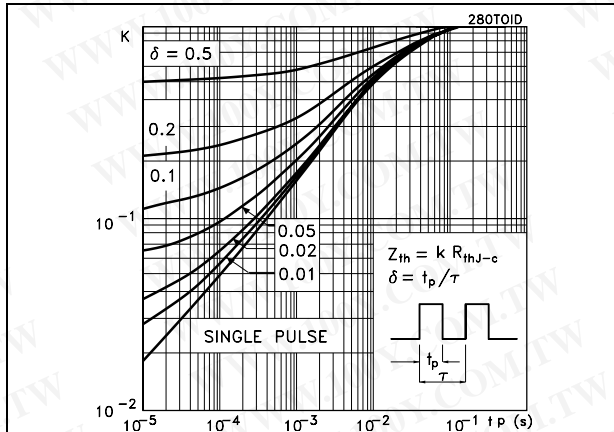

Figure 14. Turn-off SOA

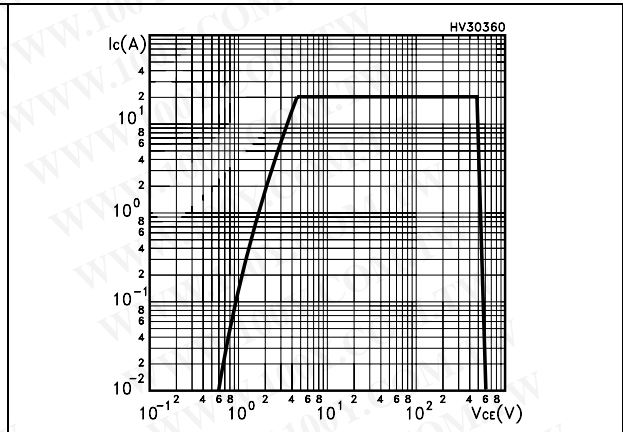

Figure 15. Thermal impedance for TO-220FP

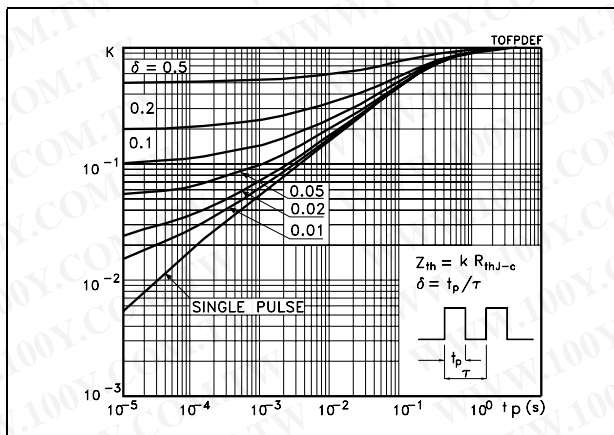
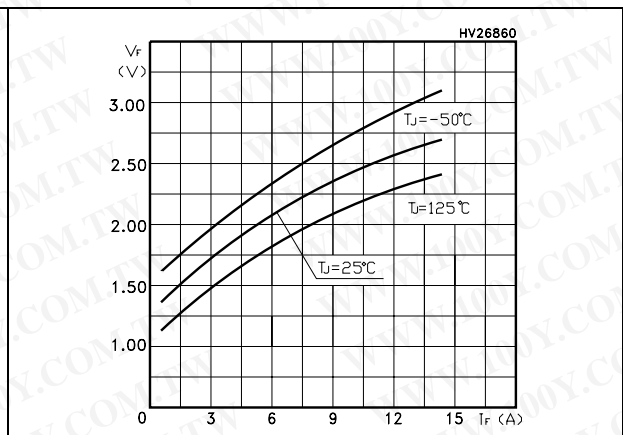

Figure 16. Emitter-collector diode characteristics



3 Test circuit

Figure 17. Test circuit for inductive load switching

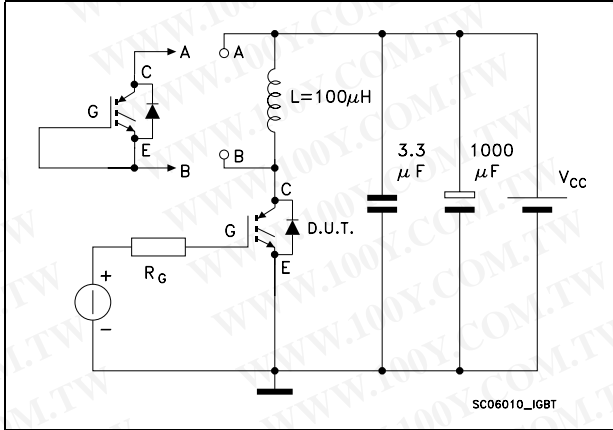

Figure 18. Gate charge test circuit

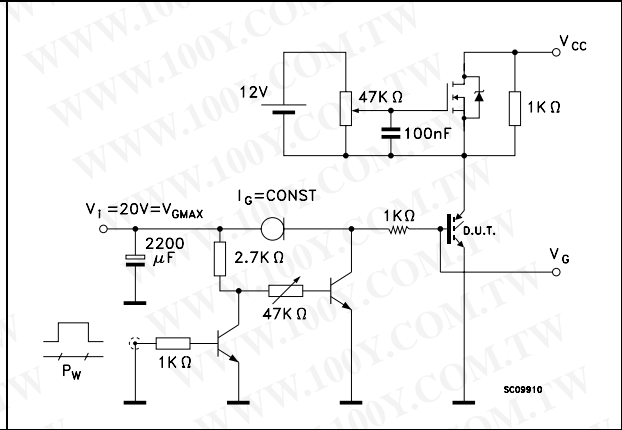

Figure 19. Switching waveform

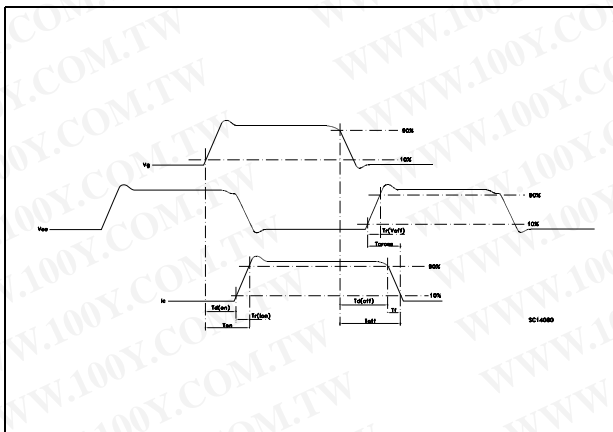
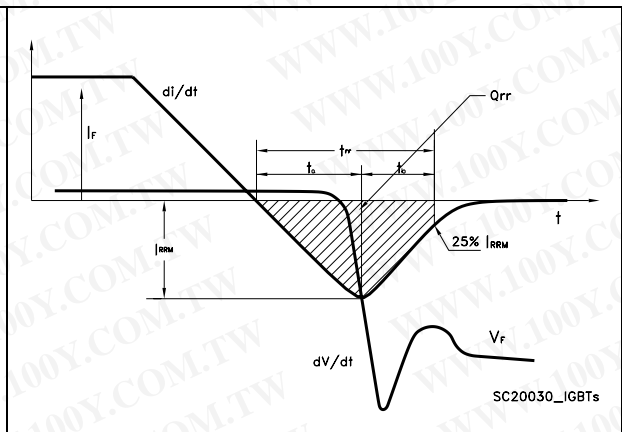

Figure 20. Diode recovery time waveform



4 Package mechanical data

In order to meet environmental requirements, ST offers these devices in ECOPACK® packages. These packages have a Lead-free second level interconnect . The category of second level interconnect is marked on the package and on the inner box label, in compliance with JEDEC Standard JESD97. The maximum ratings related to soldering conditions are also marked on the inner box label. ECOPACK is an ST trademark. ECOPACK specifications are available at : www.st.com

TO-220 MECHANICAL DATA

DIM.	mm.			inch		
	MIN.	TYP	MAX.	MIN.	TYP.	MAX.
A	4.40		4.60	0.173		0.181
b	0.61		0.88	0.024		0.034
b1	1.15		1.70	0.045		0.066
c	0.49		0.70	0.019		0.027
D	15.25		15.75	0.60		0.620
E	10		10.40	0.393		0.409
e	2.40		2.70	0.094		0.106
e1	4.95		5.15	0.194		0.202
F	1.23		1.32	0.048		0.052
H1	6.20		6.60	0.244		0.256
J1	2.40		2.72	0.094		0.107
L	13		14	0.511		0.551
L1	3.50		3.93	0.137		0.154
L20		16.40			0.645	
L30		28.90			1.137	
øP	3.75		3.85	0.147		0.151
Q	2.65		2.95	0.104		0.116

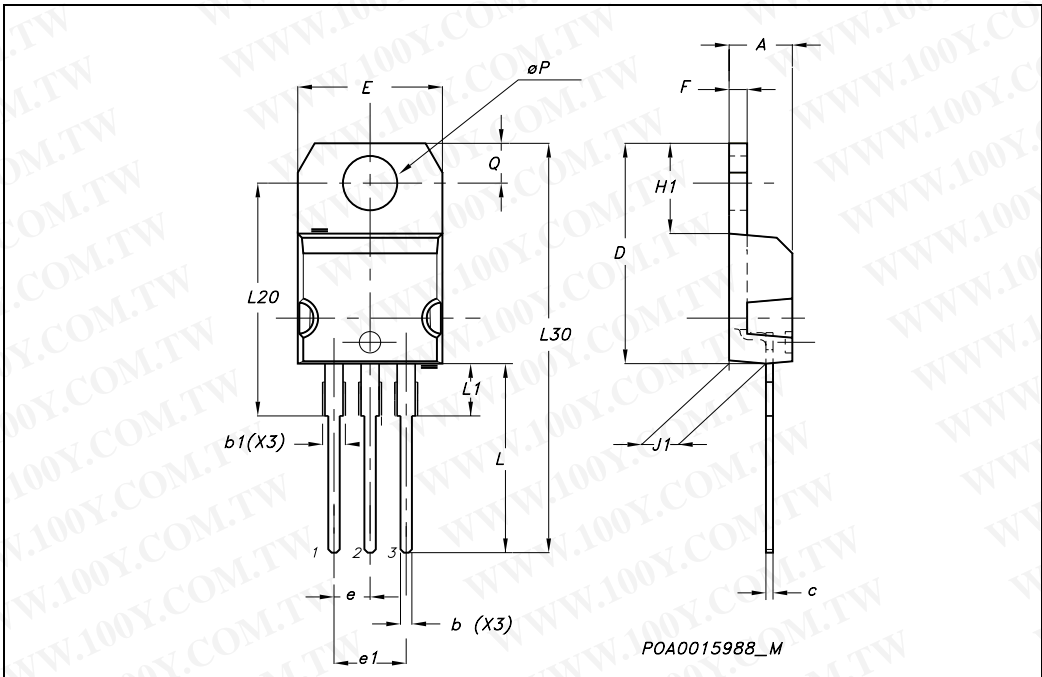

TO-262 (I²PAK) MECHANICAL DATA

DIM.	mm.			inch		
	MIN.	TYP.	MAX.	MIN.	TYP.	MAX.
A	4.40		4.60	0.173		0.181
A1	2.40		2.72	0.094		0.107
b	0.61		0.88	0.024		0.034
b1	1.14		1.70	0.044		0.066
c	0.49		0.70	0.019		0.027
c2	1.23		1.32	0.048		0.052
D	8.95		9.35	0.352		0.368
e	2.40		2.70	0.094		0.106
e1	4.95		5.15	0.194		0.202
E	10		10.40	0.393		0.410
L	13		14	0.511		0.551
L1	3.50		3.93	0.137		0.154
L2	1.27		1.40	0.050		0.055

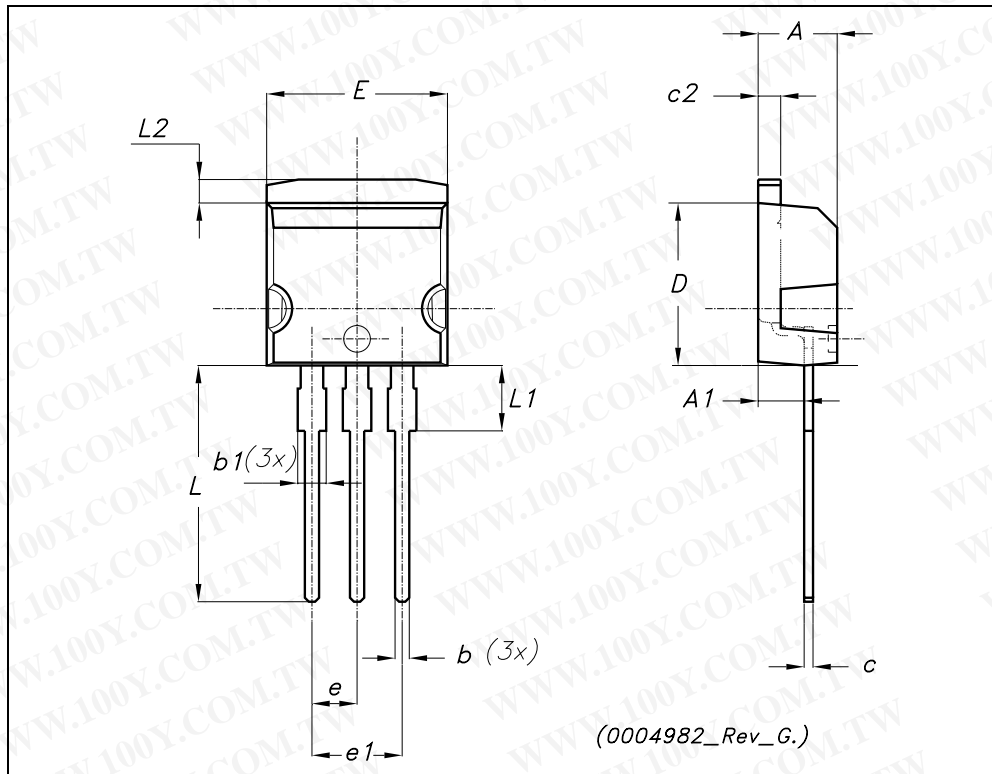

D²PAK MECHANICAL DATA

DIM.	mm.			inch		
	MIN.	TYP.	MAX.	MIN.	TYP.	MAX.
A	4.4		4.6	0.173		0.181
A1	2.49		2.69	0.098		0.106
A2	0.03		0.23	0.001		0.009
B	0.7		0.93	0.027		0.036
B2	1.14		1.7	0.044		0.067
C	0.45		0.6	0.017		0.023
C2	1.23		1.36	0.048		0.053
D	8.95		9.35	0.352		0.368
D1		8			0.315	
E	10		10.4	0.393		
E1		8.5			0.334	
G	4.88		5.28	0.192		0.208
L	15		15.85	0.590		0.625
L2	1.27		1.4	0.050		0.055
L3	1.4		1.75	0.055		0.068
M	2.4		3.2	0.094		0.126
R		0.4			0.015	
V2	0°		4°			

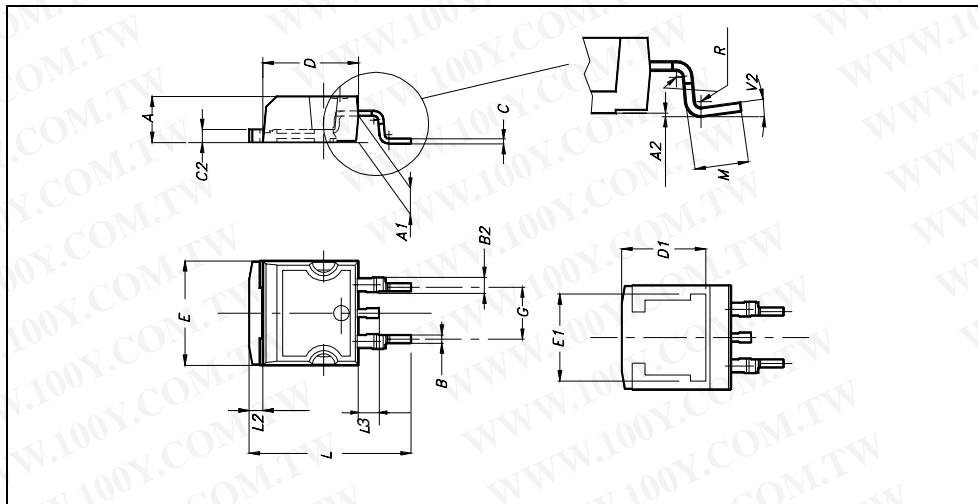

TO-220FP MECHANICAL DATA

DIM.	mm.			inch		
	MIN.	TYP.	MAX.	MIN.	TYP.	MAX.
A	4.4		4.6	0.173		0.181
B	2.5		2.7	0.098		0.106
D	2.5		2.75	0.098		0.108
E	0.45		0.7	0.017		0.027
F	0.75		1	0.030		0.039
F1	1.15		1.7	0.045		0.067
F2	1.15		1.7	0.045		0.067
G	4.95		5.2	0.195		0.204
G1	2.4		2.7	0.094		0.106
H	10		10.4	0.393		0.409
L2		16			0.630	
L3	28.6		30.6	1.126		1.204
L4	9.8		10.6	.0385		0.417
L5	2.9		3.6	0.114		0.141
L6	15.9		16.4	0.626		0.645
L7	9		9.3	0.354		0.366
Ø	3		3.2	0.118		0.126

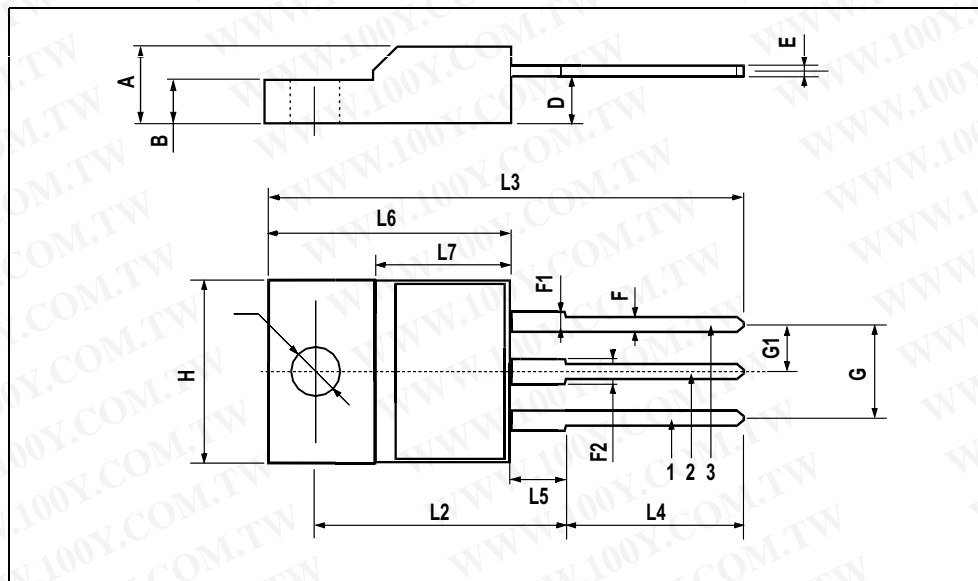

5 Packaging mechanical data

D²PAK FOOTPRINT

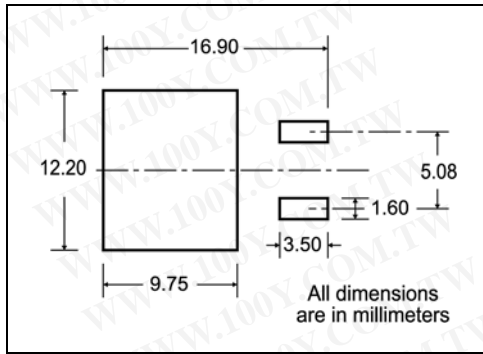

TAPE AND REEL SHIPMENT

TAPE MECHANICAL DATA

DIM.	mm		inch	
	MIN.	MAX.	MIN.	MAX.
A0	10.5	10.7	0.413	0.421
B0	15.7	15.9	0.618	0.626
D	1.5	1.6	0.059	0.063
D1	1.59	1.61	0.062	0.063
E	1.65	1.85	0.065	0.073
F	11.4	11.6	0.449	0.456
K0	4.8	5.0	0.189	0.197
P0	3.9	4.1	0.153	0.161
P1	11.9	12.1	0.468	0.476
P2	1.9	2.1	0.075	0.082
R	50		1.574	
T	0.25	0.35	0.0098	0.0137
W	23.7	24.3	0.933	0.956

REEL MECHANICAL DATA

DIM.	mm		inch	
	MIN.	MAX.	MIN.	MAX.
A		330		12.992
B	1.5		0.059	
C	12.8	13.2	0.504	0.520
D	20.2		0.795	
G	24.4	26.4	0.960	1.039
N	100		3.937	
T		30.4		1.197

BASE QTY	BULK QTY
1000	1000

* on sales type

6 Revision history

Table 8. Revision history

Date	Revision	Changes
28-Nov-2005	1	First Release
07-Mar-2006	2	Complete version
31-Jul-2006	3	Modified Figure 10 .
26-Apr-2007	4	Inserted package I ² PAK

勝特力材料 886-3-5753170
勝特力电子(上海) 86-21-34970699
勝特力电子(深圳) 86-755-83298787
[Http://www.100y.com.tw](http://www.100y.com.tw)

Please Read Carefully:

Information in this document is provided solely in connection with ST products. STMicroelectronics NV and its subsidiaries ("ST") reserve the right to make changes, corrections, modifications or improvements, to this document, and the products and services described herein at any time, without notice.

All ST products are sold pursuant to ST's terms and conditions of sale.

Purchasers are solely responsible for the choice, selection and use of the ST products and services described herein, and ST assumes no liability whatsoever relating to the choice, selection or use of the ST products and services described herein.

No license, express or implied, by estoppel or otherwise, to any intellectual property rights is granted under this document. If any part of this document refers to any third party products or services it shall not be deemed a license grant by ST for the use of such third party products or services, or any intellectual property contained therein or considered as a warranty covering the use in any manner whatsoever of such third party products or services or any intellectual property contained therein.

UNLESS OTHERWISE SET FORTH IN ST'S TERMS AND CONDITIONS OF SALE ST DISCLAIMS ANY EXPRESS OR IMPLIED WARRANTY WITH RESPECT TO THE USE AND/OR SALE OF ST PRODUCTS INCLUDING WITHOUT LIMITATION IMPLIED WARRANTIES OF MERCHANTABILITY, FITNESS FOR A PARTICULAR PURPOSE (AND THEIR EQUIVALENTS UNDER THE LAWS OF ANY JURISDICTION), OR INFRINGEMENT OF ANY PATENT, COPYRIGHT OR OTHER INTELLECTUAL PROPERTY RIGHT.

UNLESS EXPRESSLY APPROVED IN WRITING BY AN AUTHORIZED ST REPRESENTATIVE, ST PRODUCTS ARE NOT RECOMMENDED, AUTHORIZED OR WARRANTED FOR USE IN MILITARY, AIR CRAFT, SPACE, LIFE SAVING, OR LIFE SUSTAINING APPLICATIONS, NOR IN PRODUCTS OR SYSTEMS WHERE FAILURE OR MALFUNCTION MAY RESULT IN PERSONAL INJURY, DEATH, OR SEVERE PROPERTY OR ENVIRONMENTAL DAMAGE. ST PRODUCTS WHICH ARE NOT SPECIFIED AS "AUTOMOTIVE GRADE" MAY ONLY BE USED IN AUTOMOTIVE APPLICATIONS AT USER'S OWN RISK.

Resale of ST products with provisions different from the statements and/or technical features set forth in this document shall immediately void any warranty granted by ST for the ST product or service described herein and shall not create or extend in any manner whatsoever, any liability of ST.

ST and the ST logo are trademarks or registered trademarks of ST in various countries.

Information in this document supersedes and replaces all information previously supplied.

The ST logo is a registered trademark of STMicroelectronics. All other names are the property of their respective owners.

© 2007 STMicroelectronics - All rights reserved

STMicroelectronics group of companies

Australia - Belgium - Brazil - Canada - China - Czech Republic - Finland - France - Germany - Hong Kong - India - Israel - Italy - Japan - Malaysia - Malta - Morocco - Singapore - Spain - Sweden - Switzerland - United Kingdom - United States of America

www.st.com