

KSC5502D/KSC5502DT

High Voltage Power Switch Switching Application

- Wide Safe Operating Area
- Built-in Free-Wheeling Diode
- Suitable for Electronic Ballast Application
- Small Variance in Storage Time
- Two Package Choices : D-PAK or TO-220

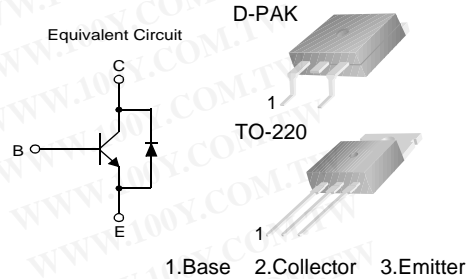

NPN Triple Diffused Planar Silicon Transistor

Absolute Maximum Ratings $T_C=25^\circ\text{C}$ unless otherwise noted

Symbol	Parameter	Value	Units
V_{CBO}	Collector-Base Voltage	1200	V
V_{CEO}	Collector-Emitter Voltage	600	V
V_{EBO}	Emitter-Base Voltage	12	V
I_C	Collector Current (DC)	2	A
I_{CP}	*Collector Current (Pulse)	4	A
I_B	Base Current (DC)	1	A
I_{BP}	*Base Current (Pulse)	2	A
P_C	Collector Dissipation ($T_C=25^\circ\text{C}$)	50	W
T_J	Junction Temperature	150	$^\circ\text{C}$
T_{STG}	Storage Temperature	- 65 ~ 150	$^\circ\text{C}$
EAS	Avalanche Energy($T_J=25^\circ\text{C}$)	2.5	mJ

* Pulse Test : Pulse Width = 5ms, Duty Cycle $\leq 10\%$

Thermal Characteristics $T_C=25^\circ\text{C}$ unless otherwise noted

Symbol	Characteristics		Rating	Unit
$R_{\theta jc}$	Thermal Resistance	Junction to Case	2.5	$^\circ\text{C/W}$
$R_{\theta ja}$		Junction to Ambient	62.5	
T_L	Maximun Lead Temperature for Soldering Purpose : 1/8" from Case for 5 seconds		270	$^\circ\text{C}$

Electrical Characteristics $T_C=25^\circ\text{C}$ unless otherwise noted

Symbol	Parameter	Test Condition	Min.	Typ.	Max.	Units	
BV_{CBO}	Collector-Base Breakdown Voltage	$I_C=1\text{mA}, I_E=0$	1200	1350		V	
BV_{CEO}	Collector-Emitter Breakdown Voltage	$I_C=5\text{mA}, I_B=0$	600	750		V	
BV_{EBO}	Emitter-Base Breakdown Voltage	$I_E=500\mu\text{A}, I_C=0$	12	13.7		V	
I_{CES}	Collector Cut-off Current	$V_{CES}=1200\text{V}, V_{BE}=0$	$T_C=25^\circ\text{C}$		100	μA	
			$T_C=125^\circ\text{C}$		500		
I_{CEO}	Collector Cut-off Current	$V_{CE}=600\text{V}, I_B=0$	$T_C=25^\circ\text{C}$		100	μA	
			$T_C=125^\circ\text{C}$		500		
I_{EBO}	Emitter Cut-off Current	$V_{EB}=12\text{V}, I_C=0$			10	μA	
h_{FE}	DC Current Gain	$V_{CE}=1\text{V}, I_C=0.2\text{A}$	$T_C=25^\circ\text{C}$	15	28	40	
			$T_C=125^\circ\text{C}$	8	18		
		$V_{CE}=1\text{V}, I_C=1\text{A}$	$T_C=25^\circ\text{C}$	4	6.4		
			$T_C=125^\circ\text{C}$	3	4.7		
		$V_{CE}=2.5\text{V}, I_C=0.5\text{A}$	$T_C=25^\circ\text{C}$	12	20	30	
			$T_C=125^\circ\text{C}$	6	12		
$V_{CE(sat)}$	Collector-Emitter Saturation Voltage	$I_C=0.2\text{A}, I_B=0.02\text{A}$	$T_C=25^\circ\text{C}$		0.31	0.8	V
			$T_C=125^\circ\text{C}$		0.54	1.1	V
		$I_C=0.4\text{A}, I_B=0.08\text{A}$	$T_C=25^\circ\text{C}$		0.15	0.6	V
			$T_C=125^\circ\text{C}$		0.23	1.0	V
		$I_C=1\text{A}, I_B=0.2\text{A}$	$T_C=25^\circ\text{C}$		0.40	1.5	V
			$T_C=125^\circ\text{C}$		1.3	3.0	V
$V_{BE(sat)}$	Base-Emitter Saturation Voltage	$I_C=0.4\text{A}, I_B=0.08\text{A}$	$T_C=25^\circ\text{C}$	0.77	1.0	V	
			$T_C=125^\circ\text{C}$	0.60	0.9	V	
		$I_C=1\text{A}, I_B=0.2\text{A}$	$T_C=25^\circ\text{C}$	0.83	1.2	V	
			$T_C=125^\circ\text{C}$	0.70	1.0	V	
C_{ib}	Input Capacitance	$V_{EB}=8\text{V}, I_C=0, f=1\text{MHz}$		385	500	pF	
C_{ob}	Output Capacitance	$V_{CB}=10\text{V}, I_E=0, f=1\text{MHz}$		60	100	pF	
f_T	Current Gain Bandwidth Product	$I_C=0.5\text{A}, V_{CE}=10\text{V}$		11		MHz	
V_F	Diode Forward Voltage	$I_F=0.2\text{A}$	$T_C=25^\circ\text{C}$	0.75	1.2	V	
			$T_C=125^\circ\text{C}$	0.59		V	
		$I_F=0.4\text{A}$	$T_C=25^\circ\text{C}$	0.80	1.3	V	
			$T_C=125^\circ\text{C}$	0.64		V	
		$I_F=1\text{A}$	$T_C=25^\circ\text{C}$	0.9	1.5	V	

Electrical Characteristics $T_C=25^\circ\text{C}$ unless otherwise noted

Symbol	Parameter	Test Condition	Min	Typ.	Max.	Units	
t_{fr}	Diode Forward Recovery Time ($di/dt=10\text{A}/\mu\text{s}$)	$I_F=0.2\text{A}$		650		ns	
		$I_F=0.4\text{A}$		740		ns	
		$I_F=1\text{A}$		785		ns	
$V_{CE(DSAT)}$	Dynamic Saturation Voltage	$I_C=0.4\text{A}, I_{B1}=80\text{mA}$ $V_{CC}=300\text{V}$	@ $1\mu\text{s}$	7.2		V	
			@ $3\mu\text{s}$	1.8		V	
		$I_C=1\text{A}, I_{B1}=200\text{mA}$ $V_{CC}=300\text{V}$	@ $1\mu\text{s}$	18		V	
			@ $3\mu\text{s}$	6		V	
RESISTIVE LOAD SWITCHING (D.C. $\leq 10\%$, Pulse Width=20s)							
t_{ON}	Turn On Time	$I_C=0.4\text{A},$ $I_{B1}=80\text{mA}$	$T_C=25^\circ\text{C}$		175	350	ns
			$T_C=125^\circ\text{C}$		185		ns
t_{OFF}	Turn Off Time	$I_{B2}=0.2\text{A},$ $V_{CC}=300\text{V}$ $R_L = 750\Omega$	$T_C=25^\circ\text{C}$		2.1	3.0	μs
			$T_C=125^\circ\text{C}$		2.6		μs
t_{ON}	Turn On Time	$I_C=1\text{A},$ $I_{B1}=160\text{mA}$	$T_C=25^\circ\text{C}$		240	450	ns
			$T_C=125^\circ\text{C}$		310		ns
t_{OFF}	Turn Off Time	$I_{B2}=160\text{mA},$ $V_{CC}=300\text{V}$ $R_L = 300\Omega$	$T_C=25^\circ\text{C}$		3.7	5.0	μs
			$T_C=125^\circ\text{C}$		4.5		μs
INDUCTIVE LOAD SWITCHING ($V_{CC}=15\text{V}$)							
t_{STG}	Storage Time	$I_C=0.4\text{A},$ $I_{B1}=80\text{mA}$	$T_C=25^\circ\text{C}$		1.2	2.0	μs
			$T_C=125^\circ\text{C}$		1.5		μs
t_F	Fall Time	$I_{B2}=0.2\text{A},$ $V_Z=300\text{V}$ $L_C=200\text{H}$	$T_C=25^\circ\text{C}$		90	200	ns
			$T_C=125^\circ\text{C}$		65		ns
t_C	Cross-over Time		$T_C=25^\circ\text{C}$		185	350	ns
			$T_C=125^\circ\text{C}$		145		ns
t_{STG}	Storage Time	$I_C=0.8\text{A},$ $I_{B1}=160\text{mA}$	$T_C=25^\circ\text{C}$		3.3	4.5	μs
			$T_C=125^\circ\text{C}$		3.75		μs
t_F	Fall Time	$I_{B2}=160\text{mA},$ $V_{CC}=300\text{V}$ $L_C=200\text{H}$	$T_C=25^\circ\text{C}$		90	250	ns
			$T_C=125^\circ\text{C}$		160		ns
t_C	Cross-over Time		$T_C=25^\circ\text{C}$		300	600	ns
			$T_C=125^\circ\text{C}$		570		ns

Typical Characteristics

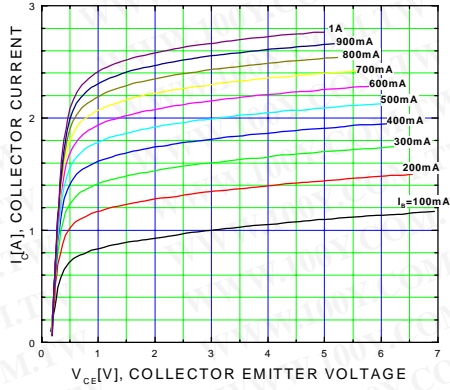

Figure 1. Static Characteristic

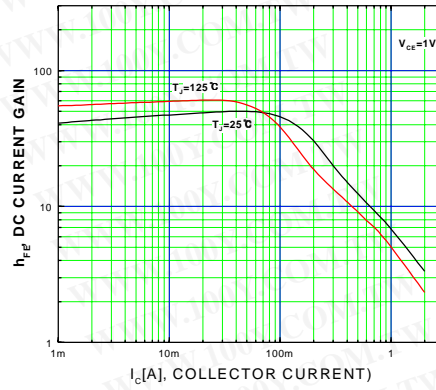

Figure 2. DC current Gain

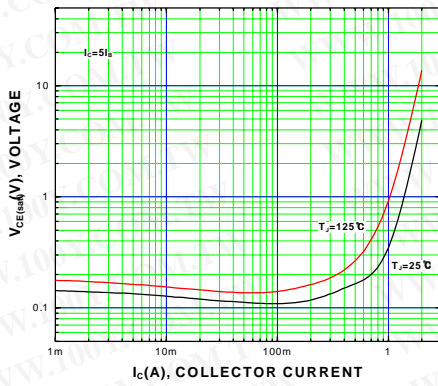

Figure 3. Collector-Emitter Saturation Voltage

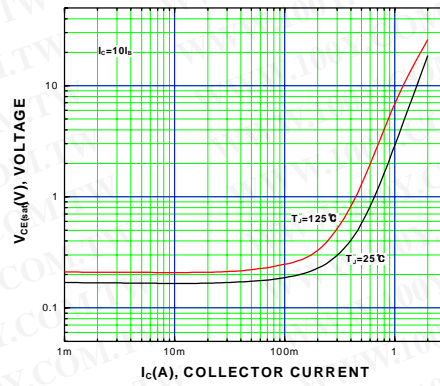

Figure 4. Collector-Emitter Saturation Voltage

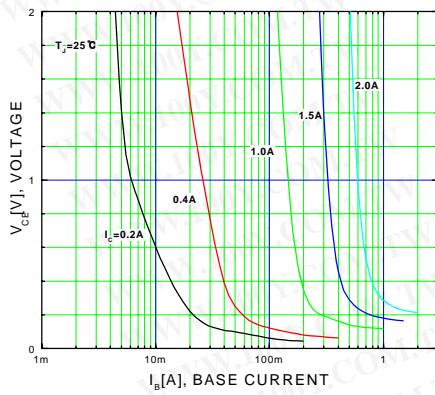

Figure 5. Typical Collector Saturation Voltage

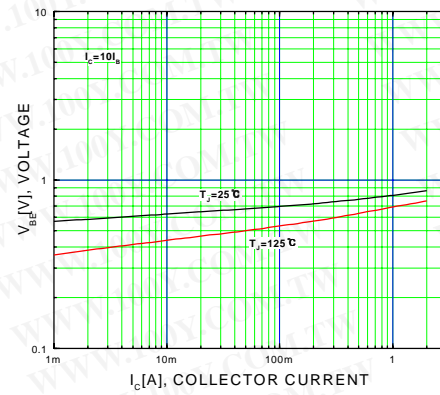

Figure 6. Base-Emitter Saturation Voltage

Typical Characteristics (Continued)

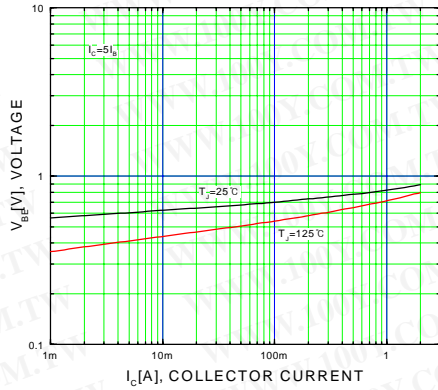

Figure 7. Base-Emitter Saturation Voltage

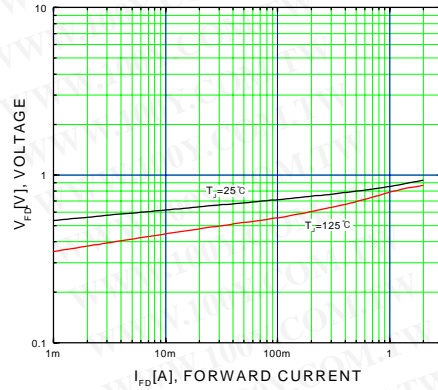

Figure 8. Diode Forward Voltage

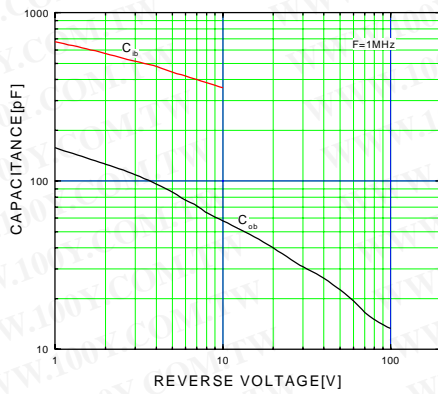

Figure 9. Collector Output Capacitance

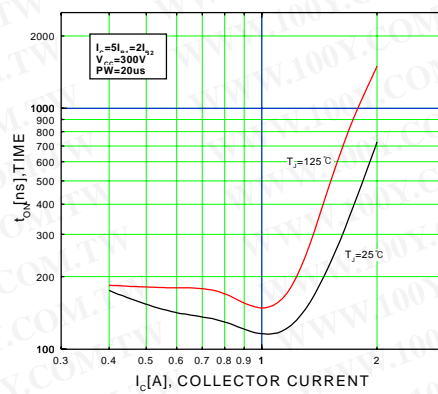

Figure 10. Resistive Switching Time, t_{on}

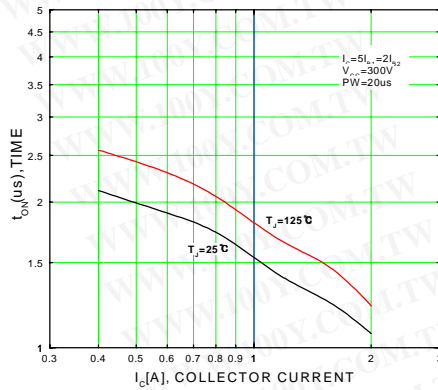

Figure 11. Resistive Switching Time, t_{off}

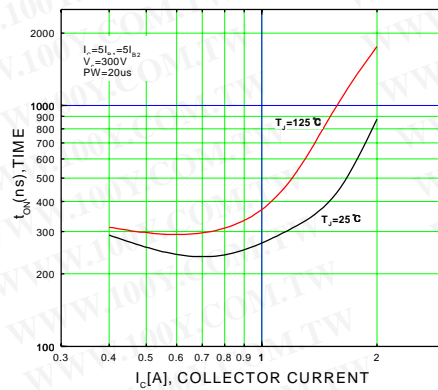

Figure 12. Resistive Switching Time, t_{on}

Typical Characteristics (Continued)

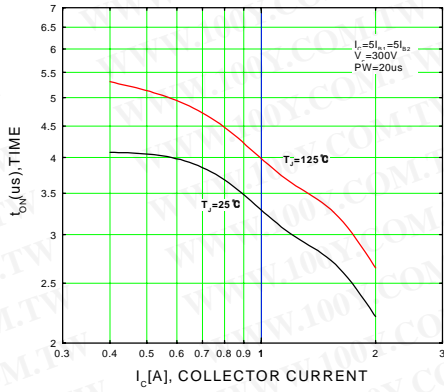

Figure 13. Resistive Switching Time, t_{on}

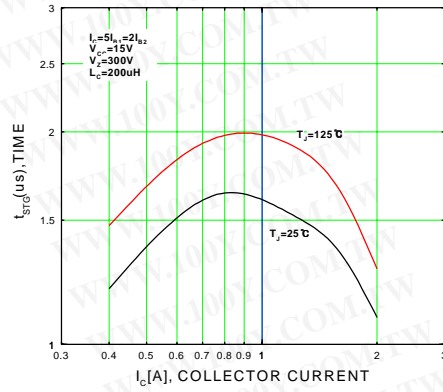

Figure 14. Inductive Switching Time, t_{STG}

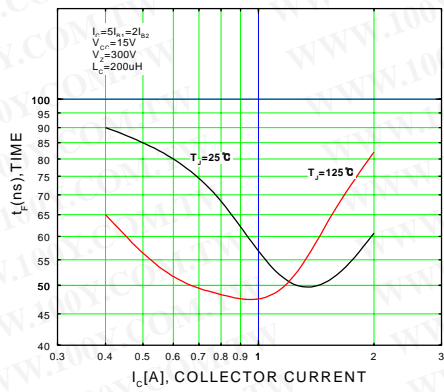

Figure 15. Inductive Switching Time, t_f

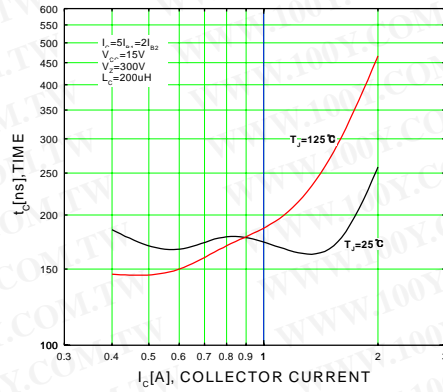

Figure 16. Inductive Switching Time, t_c

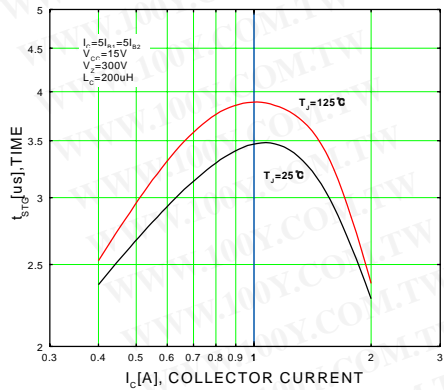

Figure 17. Inductive Switching Time, t_{STG}

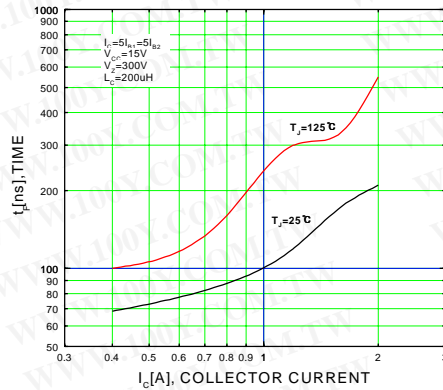

Figure 18. Inductive Switching Time, t_f

Typical Characteristics (Continued)

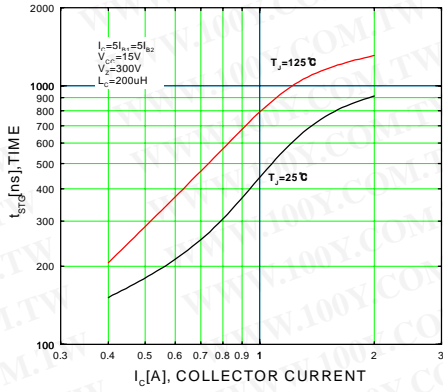

Figure 19. Inductive Switching Time, t_c

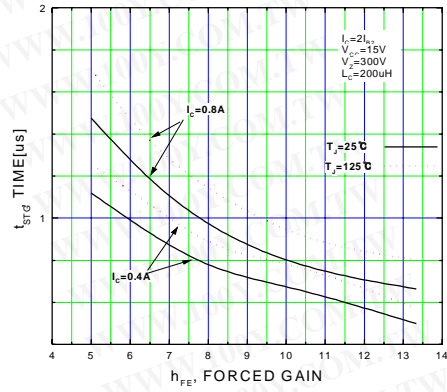

Figure 20. Inductive Switching Time, t_{STG}

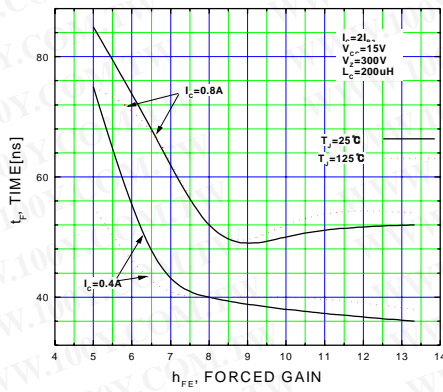

Figure 21. Inductive Switching Time, t_f

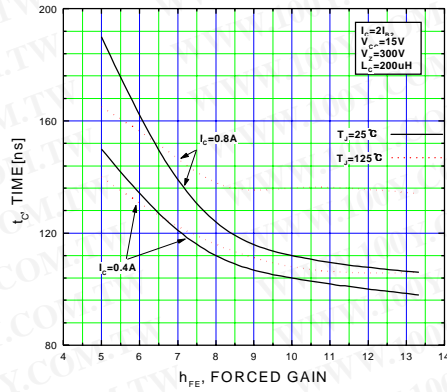

Figure 22. Inductive Switching Time, t_c

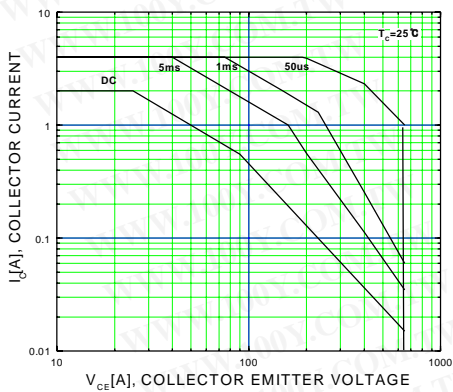

Figure 23. Forward Bias Safe Operating Area

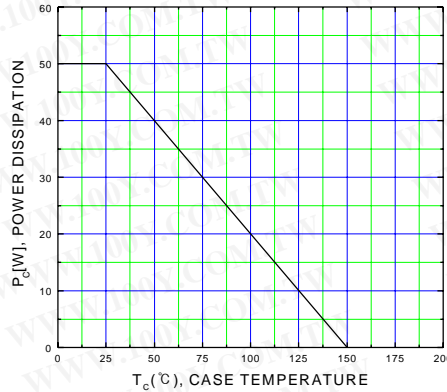

Figure 24. Power Derating

Typical Characteristics (Continued)

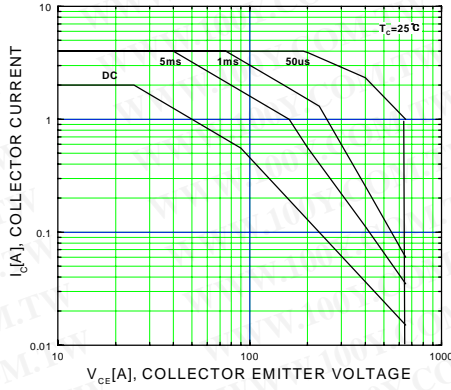

Figure 25. Forward Bias Safe Operating Area

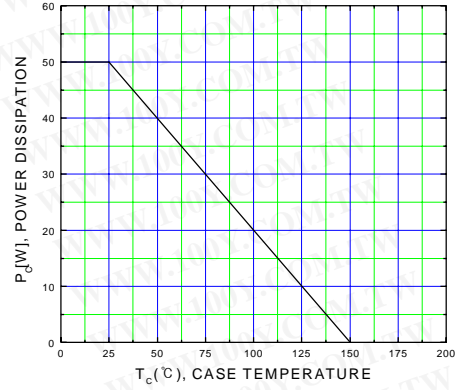
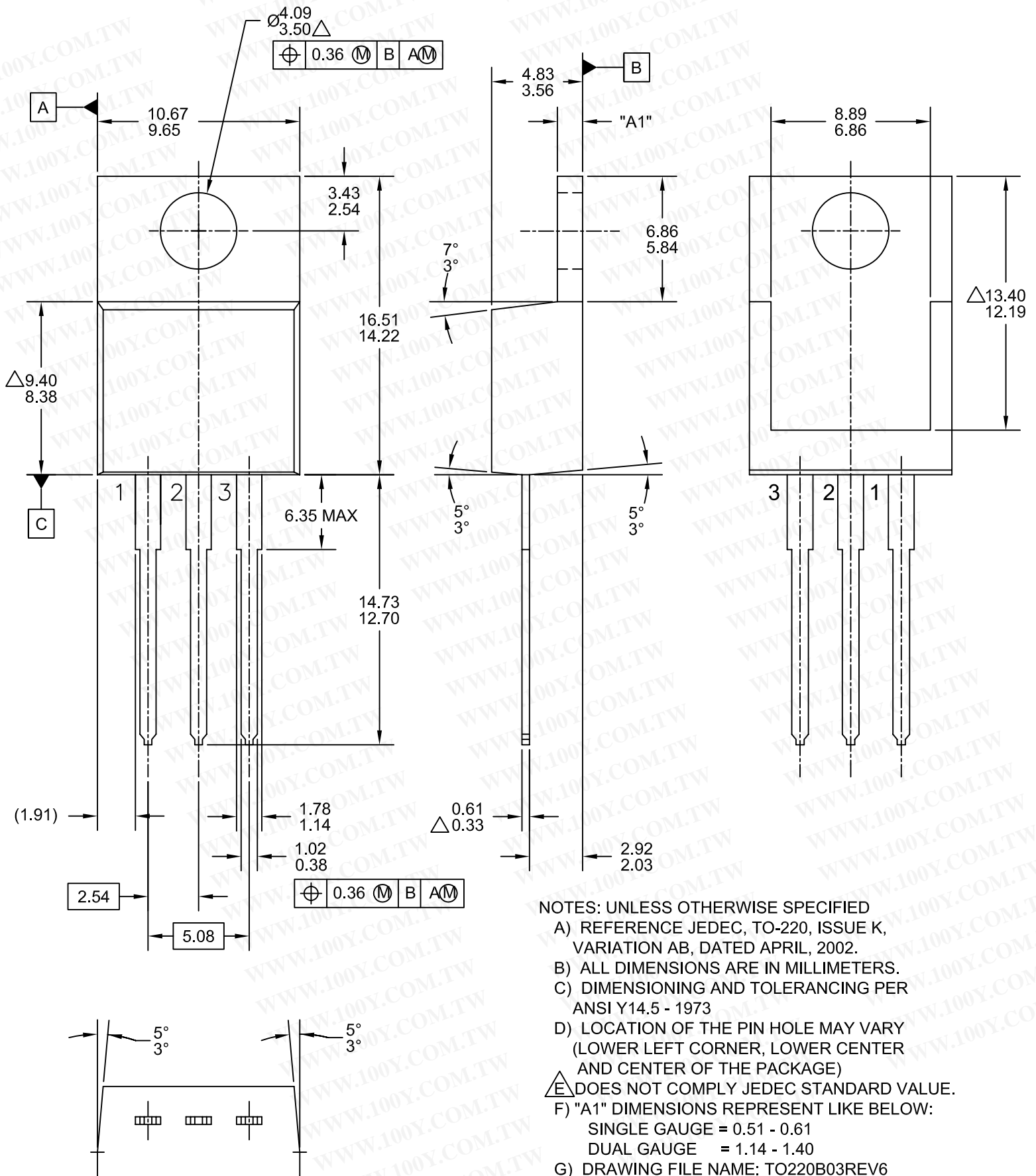

Figure 26. Power Derating

TO-220

Dimensions are in mm



NOTES: UNLESS OTHERWISE SPECIFIED

- A) REFERENCE JEDEC, TO-220, ISSUE K, VARIATION AB, DATED APRIL, 2002.
- B) ALL DIMENSIONS ARE IN MILLIMETERS.
- C) DIMENSIONING AND TOLERANCING PER ANSI Y14.5 - 1973
- D) LOCATION OF THE PIN HOLE MAY VARY (LOWER LEFT CORNER, LOWER CENTER AND CENTER OF THE PACKAGE)
- E) DOES NOT COMPLY JEDEC STANDARD VALUE.
- F) "A1" DIMENSIONS REPRESENT LIKE BELOW:
 SINGLE GAUGE = 0.51 - 0.61
 DUAL GAUGE = 1.14 - 1.40
- G) DRAWING FILE NAME: TO220B03REV6

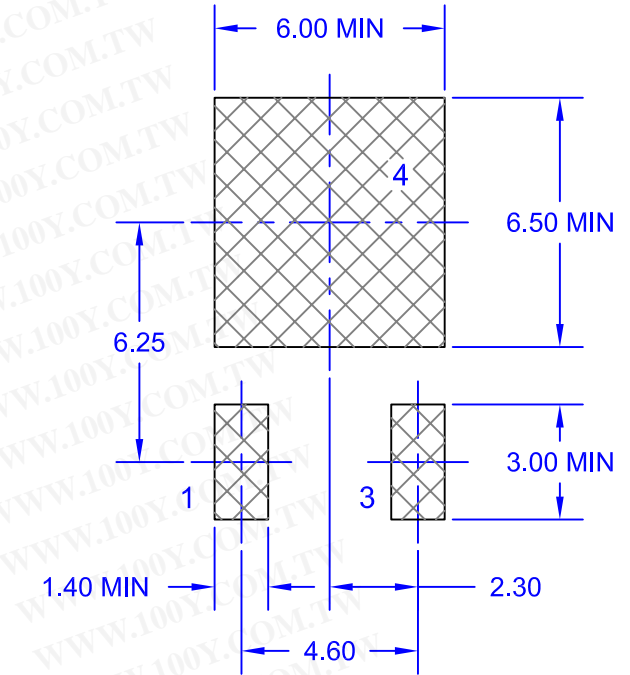
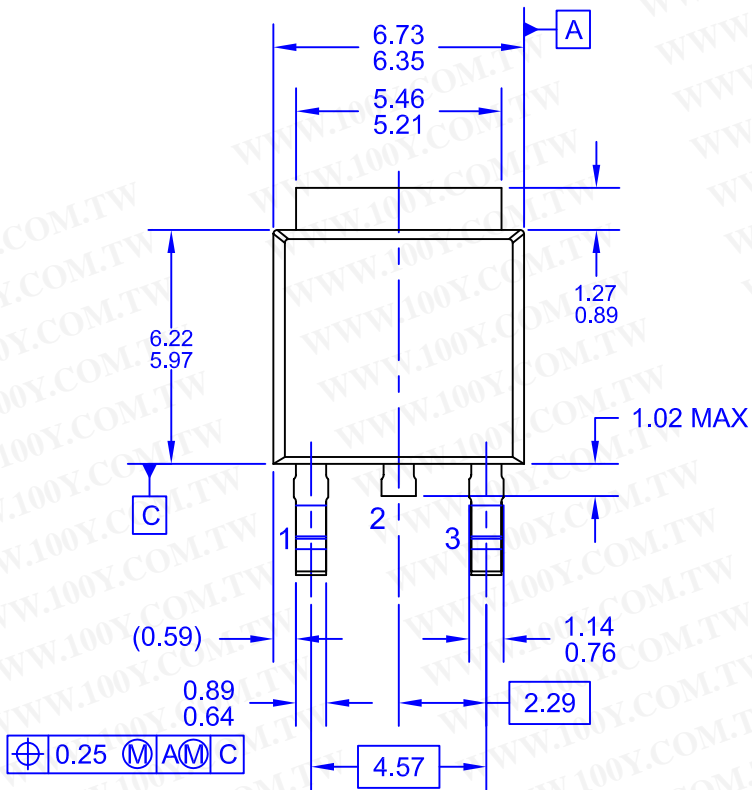

LAND PATTERN RECOMMENDATION

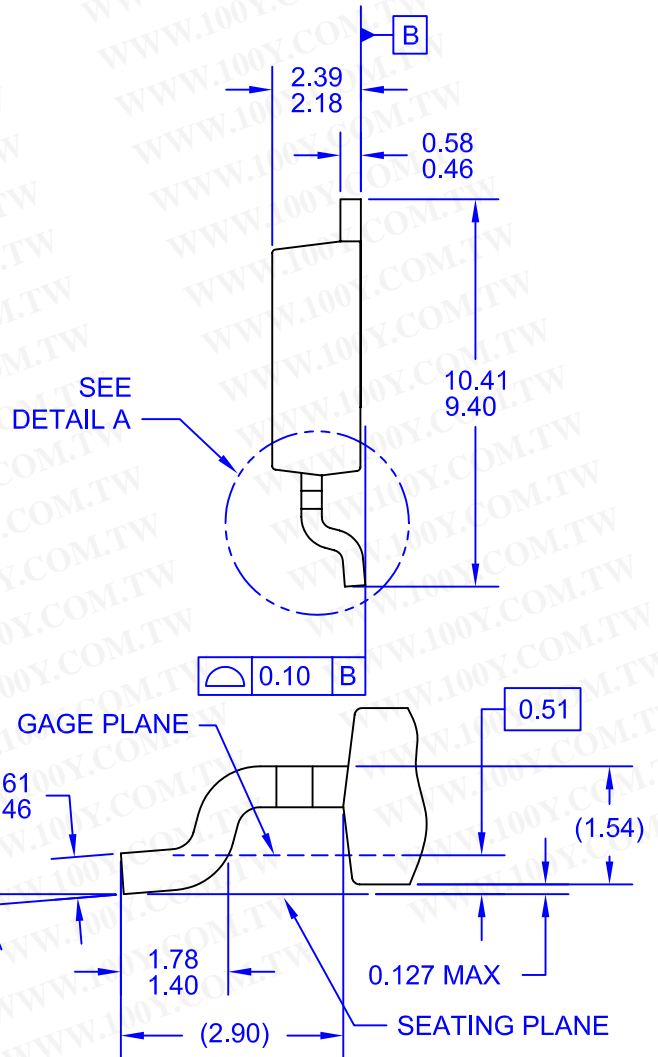
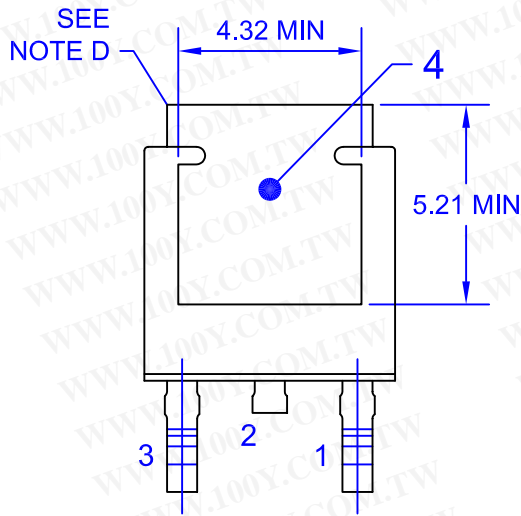





NOTES: UNLESS OTHERWISE SPECIFIED

- A) THIS PACKAGE CONFORMS TO JEDEC, TO-252, ISSUE C, VARIATION AA.
- B) ALL DIMENSIONS ARE IN MILLIMETERS.
- C) DIMENSIONING AND TOLERANCING PER ASME Y14.5M-1994.
- D) HEAT SINK TOP EDGE COULD BE IN CHAMFERED CORNERS OR EDGE PROTRUSION.
- E) PRESENCE OF TRIMMED CENTER LEAD IS OPTIONAL.
- F) DIMENSIONS ARE EXCLUSIVE OF BURSS, MOLD FLASH AND TIE BAR EXTRUSIONS.
- G) LAND PATTERN RECOMENDATION IS BASED ON IPC7351A STD TO220P1003X238-3N.
- H) DRAWING NUMBER AND REVISION: MKT-TO252A03REV8

TRADEMARKS

The following includes registered and unregistered trademarks and service marks, owned by Fairchild Semiconductor and/or its global subsidiaries, and is not intended to be an exhaustive list of all such trademarks.

2Cool™	FPS™		Sync-Lock™
AccuPower™	F-PFS™		 SYSTEM GENERAL®
AX-CAP®*	FRFET®		TinyBoost™
BitSiC™	Global Power Resource SM	 PowerTrench®	TinyBuck™
Build it Now™	GreenBridge™	PowerXS™	TinyCalc™
CorePLUS™	Green FPS™	Programmable Active Droop™	TinyLogic®
CorePOWER™	Green FPS™ e-Series™	QFET®	TINYOPTO™
CROSSVOL™	Gmax™	QS™	TinyPower™
CTL™	GTO™	Quiet Series™	TinyPWM™
Current Transfer Logic™	IntelliMAX™	RapidConfigure™	TinyWire™
DEUXPEED®	ISOPLANAR™	 Saving our world, 1mW/W/kW at a time™	TranSiC™
Dual Cool™	Making Small Speakers Sound Louder and Better™	SignalWise™	TriFault Detect™
EcoSPARK®	MegaBuck™	SmartMax™	TRUECURRENT®*
EfficientMax™	MICROCOUPLER™	SMART START™	µSerDes™
ESBC™	MicroFET™	Solutions for Your Success™	 SerDes™
 Fairchild®	MicroPak™	SPM®	UHC®
Fairchild Semiconductor®	MicroPak2™	STEALTH™	Ultra FRFET™
FACT Quiet Series™	MillerDrive™	SuperFET®	UniFET™
FACT®	MotionMax™	SuperSOT™-3	VCC™
FAST®	mWSaver™	SuperSOT™-6	VisualMax™
FastvCore™	OptoHiT™	SuperSOT™-8	VoltagePlus™
FETBench™	OPTOLOGIC®	SupreMOS®	XST™
	OPTOPLANAR®	SyncFET™	

* Trademarks of System General Corporation, used under license by Fairchild Semiconductor.

DISCLAIMER

FAIRCHILD SEMICONDUCTOR RESERVES THE RIGHT TO MAKE CHANGES WITHOUT FURTHER NOTICE TO ANY PRODUCTS HEREIN TO IMPROVE RELIABILITY, FUNCTION, OR DESIGN. FAIRCHILD DOES NOT ASSUME ANY LIABILITY ARISING OUT OF THE APPLICATION OR USE OF ANY PRODUCT OR CIRCUIT DESCRIBED HEREIN; NEITHER DOES IT CONVEY ANY LICENSE UNDER ITS PATENT RIGHTS, NOR THE RIGHTS OF OTHERS. THESE SPECIFICATIONS DO NOT EXPAND THE TERMS OF FAIRCHILD'S WORLDWIDE TERMS AND CONDITIONS, SPECIFICALLY THE WARRANTY THEREIN, WHICH COVERS THESE PRODUCTS.

LIFE SUPPORT POLICY

FAIRCHILD'S PRODUCTS ARE NOT AUTHORIZED FOR USE AS CRITICAL COMPONENTS IN LIFE SUPPORT DEVICES OR SYSTEMS WITHOUT THE EXPRESS WRITTEN APPROVAL OF FAIRCHILD SEMICONDUCTOR CORPORATION.

As used herein:

1. Life support devices or systems are devices or systems which, (a) are intended for surgical implant into the body or (b) support or sustain life, and (c) whose failure to perform when properly used in accordance with instructions for use provided in the labeling, can be reasonably expected to result in a significant injury of the user.
2. A critical component in any component of a life support, device, or system whose failure to perform can be reasonably expected to cause the failure of the life support device or system, or to affect its safety or effectiveness.

ANTI-COUNTERFEITING POLICY

Fairchild Semiconductor Corporation's Anti-Counterfeiting Policy. Fairchild's Anti-Counterfeiting Policy is also stated on our external website, www.fairchildsemi.com, under Sales Support.

Counterfeiting of semiconductor parts is a growing problem in the industry. All manufacturers of semiconductor products are experiencing counterfeiting of their parts. Customers who inadvertently purchase counterfeit parts experience many problems such as loss of brand reputation, substandard performance, failed applications, and increased cost of production and manufacturing delays. Fairchild is taking strong measures to protect ourselves and our customers from the proliferation of counterfeit parts. Fairchild strongly encourages customers to purchase Fairchild parts either directly from Fairchild or from Authorized Fairchild Distributors who are listed by country on our web page cited above. Products customers buy either from Fairchild directly or from Authorized Fairchild Distributors are genuine parts, have full traceability, meet Fairchild's quality standards for handling and storage and provide access to Fairchild's full range of up-to-date technical and product information. Fairchild and our Authorized Distributors will stand behind all warranties and will appropriately address any warranty issues that may arise. Fairchild will not provide any warranty coverage or other assistance for parts bought from Unauthorized Sources. Fairchild is committed to combat this global problem and encourage our customers to do their part in stopping this practice by buying direct or from authorized distributors.

PRODUCT STATUS DEFINITIONS

Definition of Terms

Datasheet Identification	Product Status	Definition
Advance Information	Formative / In Design	Datasheet contains the design specifications for product development. Specifications may change in any manner without notice.
Preliminary	First Production	Datasheet contains preliminary data; supplementary data will be published at a later date. Fairchild Semiconductor reserves the right to make changes at any time without notice to improve design.
No Identification Needed	Full Production	Datasheet contains final specifications. Fairchild Semiconductor reserves the right to make changes at any time without notice to improve the design.
Obsolete	Not In Production	Datasheet contains specifications on a product that is discontinued by Fairchild Semiconductor. The datasheet is for reference information only.

Rev. I64