

**HIGH VOLTAGE FASTSWITCHING NPN  
 POWER TRANSISTOR**

- HIGH VOLTAGE CAPABILITY
- VERY HIGH SWITCHING SPEED
- LOW BASE-DRIVE REQUIREMENTS

**APPLICATIONS:**

- SWITCH MODE POWER SUPPLIES
- HORIZONTAL DEFLECTION FOR COLOUR TVS AND MONITORS

**DESCRIPTION**

The SGSF344 is manufactured using Multi-epitaxial Mesa technology for cost-effective high performance and uses a Hollow Emitter structure to enhance switching speeds.

The SGSF series is designed for high speed switching applications such as power supplies and horizontal deflection circuits in TVs and monitors.

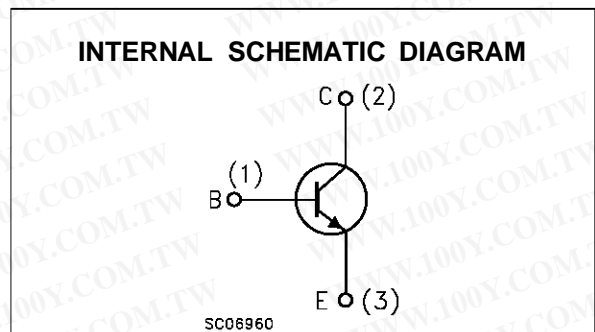
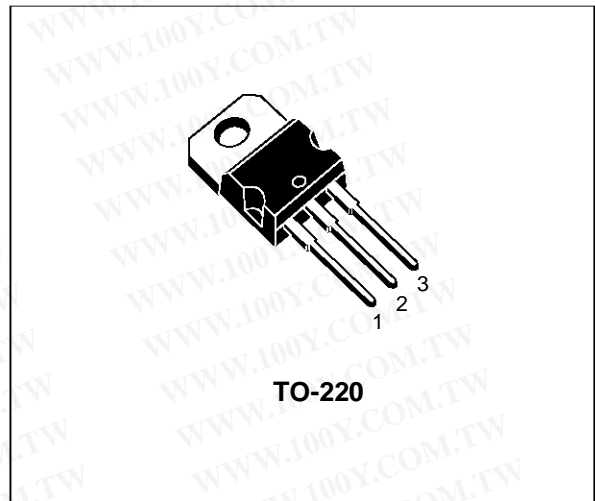

**ABSOLUTE MAXIMUM RATINGS**

Symbol	Parameter	Value	Unit
$V_{CES}$	Collector-Emitter Voltage ( $V_{BE} = 0$ )	1200	V
$V_{CEO}$	Collector-Emitter Voltage ( $I_B = 0$ )	600	V
$V_{EBO}$	Emitter-Base Voltage ( $I_C = 0$ )	7	V
$I_C$	Collector Current	7	A
$I_{CM}$	Collector Peak Current ( $t_p < 5$ ms)	12	A
$I_B$	Base Current	5	A
$I_{BM}$	Base Peak Current ( $t_p < 5$ ms)	8	A
$P_{tot}$	Total Dissipation at $T_c = 25$ °C	85	W
$T_{stg}$	Storage Temperature	-65 to 150	°C
$T_j$	Max. Operating Junction Temperature	150	°C

**THERMAL DATA**

R <sub>thj-case</sub>	Thermal Resistance Junction-case	Max	1.5	°C/W
-----------------------	----------------------------------	-----	-----	------

**ELECTRICAL CHARACTERISTICS** (T<sub>case</sub> = 25 °C unless otherwise specified)

Symbol	Parameter	Test Conditions	Min.	Typ.	Max.	Unit
I <sub>CES</sub>	Collector Cut-off Current (V <sub>BE</sub> = 0)	V <sub>CE</sub> = 1200 V			200	μA
I <sub>CEO</sub>	Collector Cut-off Current (I <sub>B</sub> = 0)	V <sub>EC</sub> = 380 V V <sub>EC</sub> = 600 V			200 2	μA mA
I <sub>EBO</sub>	Emitter Cut-off Current (I <sub>C</sub> = 0)	V <sub>BE</sub> = 7 V			1	mA
V <sub>CEO(sus)*</sub>	Collector-Emitter Sustaining Voltage	I <sub>C</sub> = 100 mA	600			V
V <sub>CE(sat)*</sub>	Collector-Emitter Saturation Voltage	I <sub>C</sub> = 3.5 A I <sub>B</sub> = 0.7 A I <sub>C</sub> = 2.5 A I <sub>B</sub> = 0.35 A			1.5 1.5	V V
V <sub>BE(sat)*</sub>	Base-Emitter Saturation Voltage	I <sub>C</sub> = 3.5 A I <sub>B</sub> = 0.7 A I <sub>C</sub> = 2.5 A I <sub>B</sub> = 0.35 A			1.5 1.5	V V
t <sub>ON</sub> t <sub>s</sub> t <sub>f</sub>	Turn-on Time Storage Time Fall Time	RESISTIVE LOAD V <sub>CC</sub> = 250 v I <sub>C</sub> = 3.5 A I <sub>B1</sub> = 0.7 A I <sub>B1</sub> = -1.4 A		0.7 2.2 0.18	1.2 3.5 0.4	μs μs μs
t <sub>ON</sub> t <sub>s</sub> t <sub>f</sub>	Turn-on Time Storage Time Fall Time	RESISTIVE LOAD V <sub>CC</sub> = 250 v I <sub>C</sub> = 3.5 A I <sub>B1</sub> = 0.7 A I <sub>B1</sub> = -1.4 A With Antisaturation Network		0.7 1.5 0.2		μs μs μs
t <sub>ON</sub> t <sub>s</sub> t <sub>f</sub>	Turn-on Time Storage Time Fall Time	RESISTIVE LOAD V <sub>CC</sub> = 250 V I <sub>C</sub> = 3.5 A I <sub>B1</sub> = 0.7 A V <sub>BE(off)</sub> = -5 V		0.7 1 0.2		μs μs μs
t <sub>s</sub> t <sub>f</sub>	Storage Time Fall Time	INDUCTIVE LOAD I <sub>C</sub> = 3.5 A h <sub>FE</sub> = 5 V <sub>CL</sub> = 450 V V <sub>BE(off)</sub> = -5 V L = 300 μH R <sub>BB</sub> = 1.2 Ω		1.4 0.1	2.8 0.2	μs μs
t <sub>s</sub> t <sub>f</sub>	Storage Time Fall Time	INDUCTIVE LOAD I <sub>C</sub> = 3.5 A h <sub>FE</sub> = 5 V <sub>CL</sub> = 450 V V <sub>BE(off)</sub> = -5 V L = 300 μH R <sub>BB</sub> = 1.2 Ω T <sub>c</sub> = 100 °C			4 0.3	μs μs

\* Pulsed: Pulse duration = 300 μs, duty cycle 1.5 %

Safe Operating Area

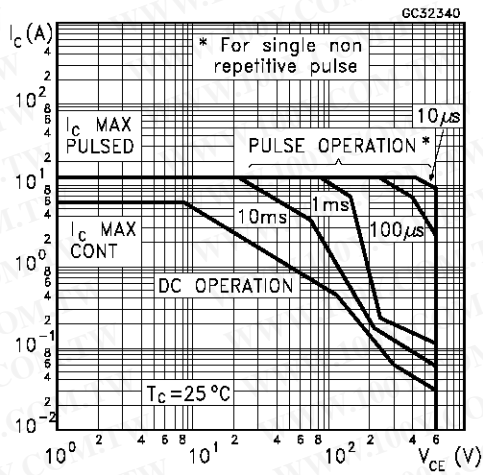

Thermal Impedance

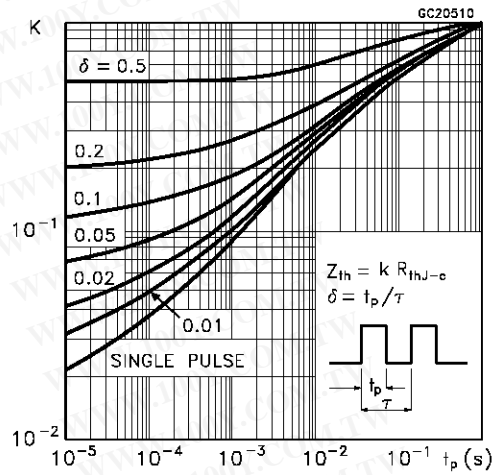

Derating Curve

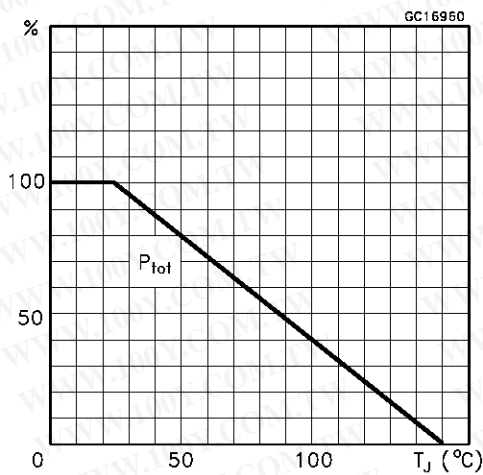

DC Current Gain

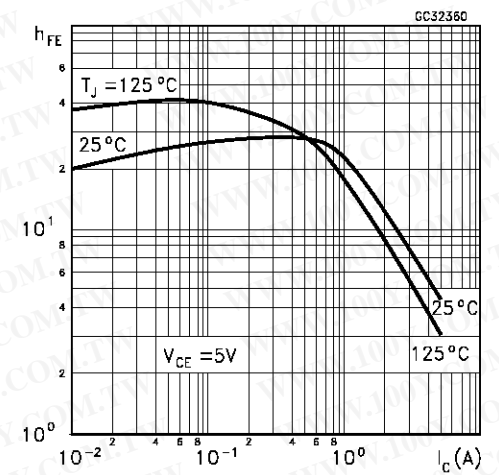

Collector Emitter Saturation Voltage

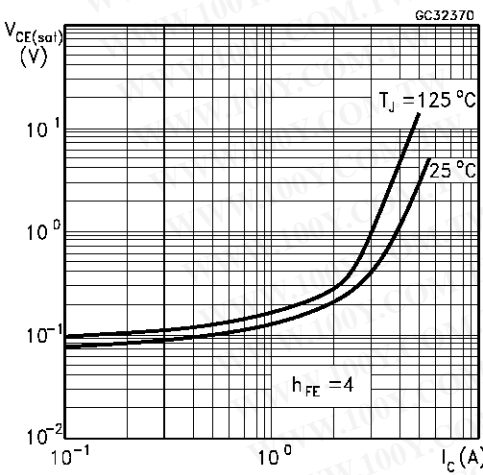

Base Emitter Saturation Voltage

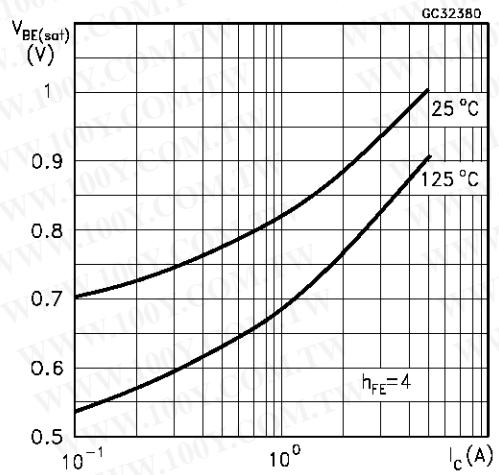

Resistive Load Switching Times

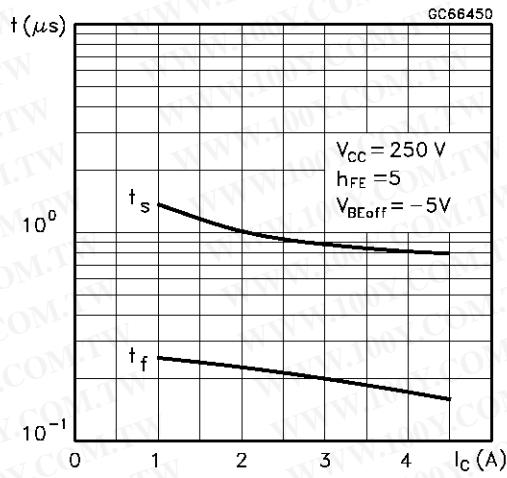

Inductive Load Switching Times

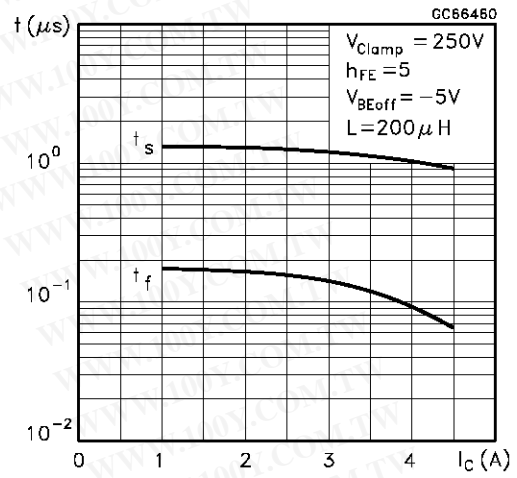

Switching Times Percentance Variation

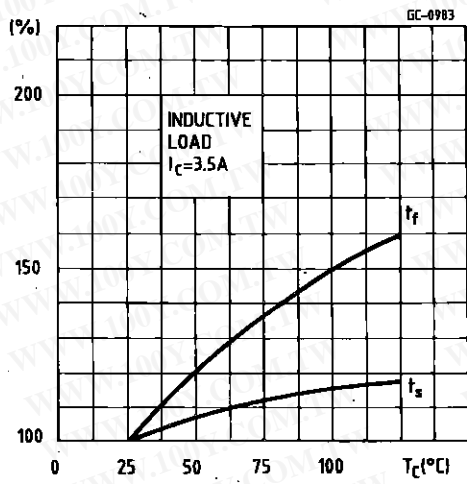

Reverse Biased SOA

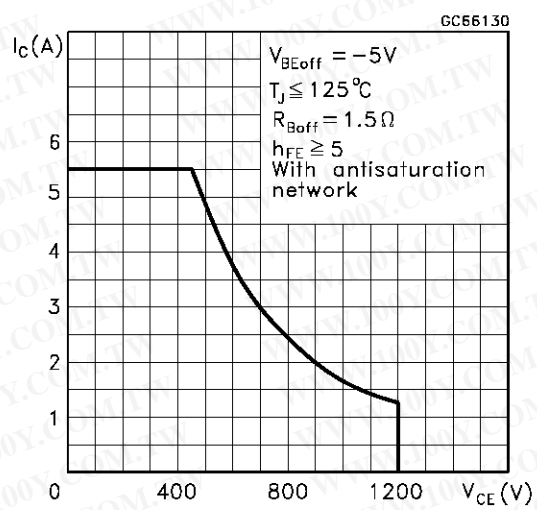

### TO-220 MECHANICAL DATA

DIM.	mm			inch		
	MIN.	TYP.	MAX.	MIN.	TYP.	MAX.
A	4.40		4.60	0.173		0.181
C	1.23		1.32	0.048		0.051
D	2.40		2.72	0.094		0.107
D1		1.27			0.050	
E	0.49		0.70	0.019		0.027
F	0.61		0.88	0.024		0.034
F1	1.14		1.70	0.044		0.067
F2	1.14		1.70	0.044		0.067
G	4.95		5.15	0.194		0.203
G1	2.4		2.7	0.094		0.106
H2	10.0		10.40	0.393		0.409
L2		16.4			0.645	
L4	13.0		14.0	0.511		0.551
L5	2.65		2.95	0.104		0.116
L6	15.25		15.75	0.600		0.620
L7	6.2		6.6	0.244		0.260
L9	3.5		3.93	0.137		0.154
DIA.	3.75		3.85	0.147		0.151

