

TO-92 Plastic-Encapsulate Transistors

S8550 TRANSISTOR (PNP)

FEATURE

- Excellent h_{FE} Linearity

勝特力材料 886-3-5753170
 勝特力电子(上海) 86-21-34970699
 勝特力电子(深圳) 86-755-83298787
[Http://www.100y.com.tw](http://www.100y.com.tw)

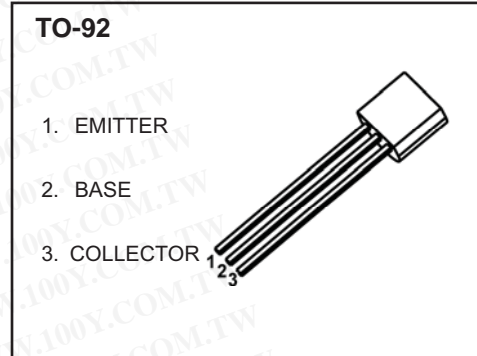

MARKING



S8550=Device code
 Solid dot=Green molding compound device,
 if none,the normal device
 Z=Rank of h_{FE} ,
 XXX=Code

Equivalent Circuit

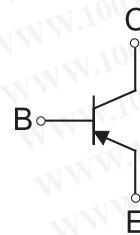

ORDERING INFORMATION

Part Number	Package	Packing Method	Pack Quantity
S8550	TO-92	Bulk	1000pcs/Bag
S8550-TA	TO-92	Tape	2000pcs/Box

MAXIMUM RATINGS ($T_a=25^{\circ}\text{C}$ unless otherwise noted)

Symbol	Parameter	Value	Unit
V_{CBO}	Collector-Base Voltage	-40	V
V_{CEO}	Collector-Emitter Voltage	-25	V
V_{EBO}	Emitter-Base Voltage	-5	V
I_C	Collector Current -Continuous	-0.5	A
P_D	Collector Power Dissipation	625	mW
$R_{\theta JA}$	Thermal Resistance from Junction to Ambient	200	$^{\circ}\text{C} / \text{W}$
T_j	Junction Temperature	150	$^{\circ}\text{C}$
T_{stg}	Storage Temperature	-55~+150	$^{\circ}\text{C}$

ELECTRICAL CHARACTERISTICS

$T_a=25^\circ\text{C}$ unless otherwise specified

Parameter	Symbol	Test conditions	Min	Typ	Max	Unit
Collector-base breakdown voltage	$V_{(BR)CBO}$	$I_C = -100\mu\text{A}, I_E = 0$	-40			V
Collector-emitter breakdown voltage	$V_{(BR)CEO}$	$I_C = -1\text{mA}, I_B = 0$	-25			V
Emitter-base breakdown voltage	$V_{(BR)EBO}$	$I_E = -100\mu\text{A}, I_C = 0$	-5			V
Collector cut-off current	I_{CBO}	$V_{CB} = -40\text{V}, I_E = 0$			-0.1	μA
Collector cut-off current	I_{CEO}	$V_{CE} = -20\text{V}, I_B = 0$			-0.1	μA
Emitter cut-off current	I_{EBO}	$V_{EB} = -3\text{V}, I_C = 0$			-0.1	μA
DC current gain	$h_{FE(1)}$	$V_{CE} = -1\text{V}, I_C = -50\text{mA}$	85		400	
	$h_{FE(2)}$	$V_{CE} = -1\text{V}, I_C = -500\text{mA}$	50			
Collector-emitter saturation voltage	$V_{CE(sat)}$	$I_C = -500\text{mA}, I_B = -50\text{mA}$			-0.6	V
Base-emitter saturation voltage	$V_{BE(sat)}$	$I_C = -500\text{mA}, I_B = -50\text{mA}$			-1.2	V
Transition frequency	f_T	$V_{CE} = -6\text{V}, I_C = -20\text{mA},$ $f = 30\text{MHz}$	150			MHz

CLASSIFICATION OF $h_{FE(1)}$

Rank	B	C	D	D3
Range	85-160	120-200	160-300	300-400

Typical Characteristics

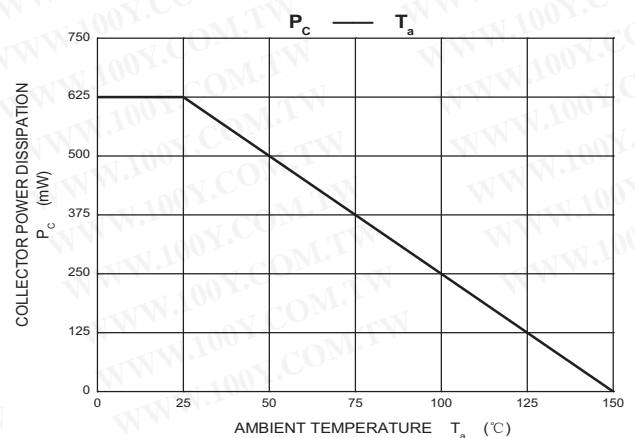
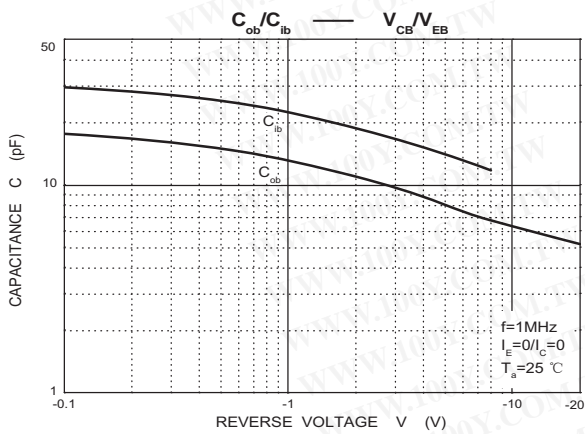
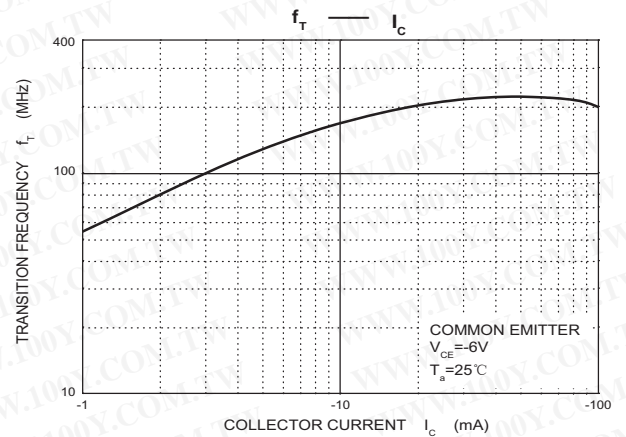
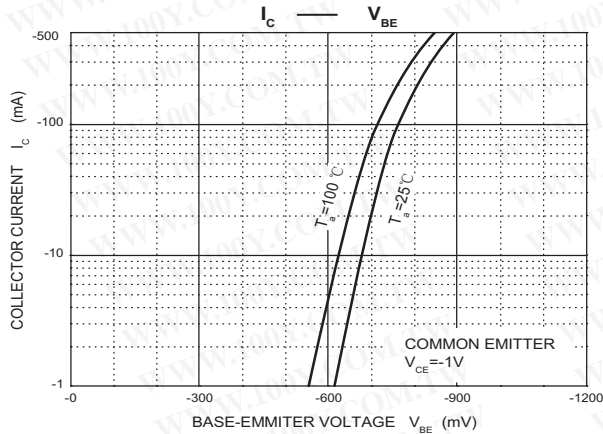
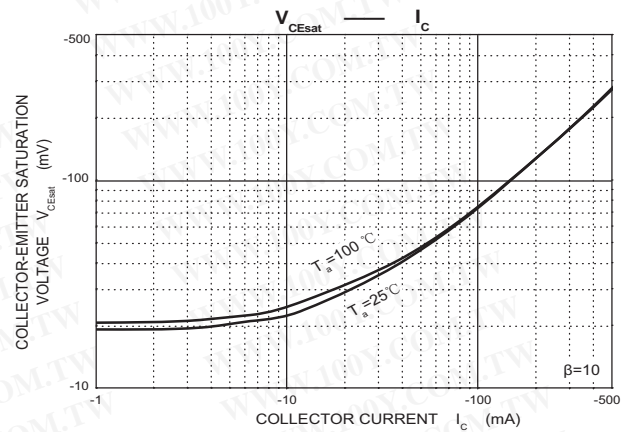
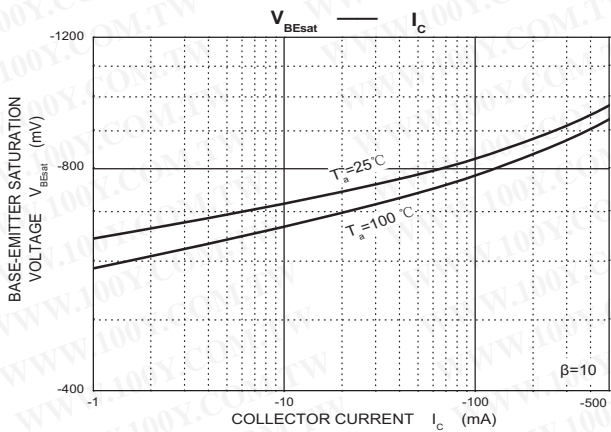
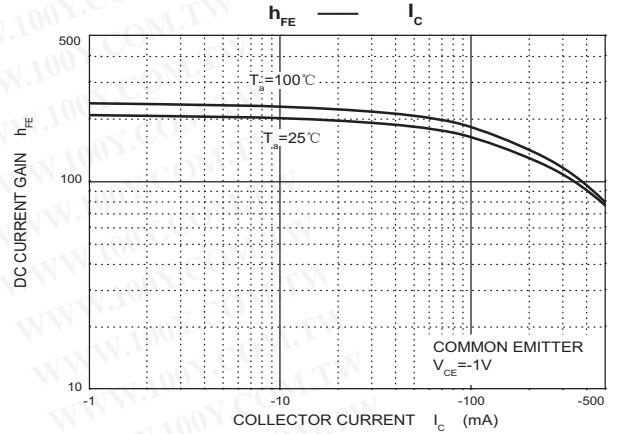
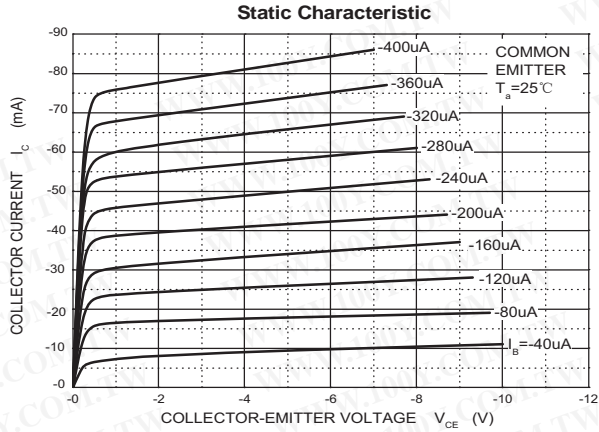

TO-92 Package Outline Dimensions

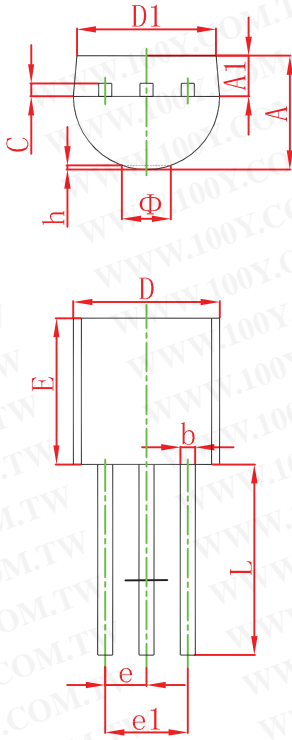

Symbol	Dimensions In Millimeters		Dimensions In Inches	
	Min	Max	Min	Max
A	3.300	3.700	0.130	0.146
A1	1.100	1.400	0.043	0.055
b	0.380	0.550	0.015	0.022
c	0.360	0.510	0.014	0.020
D	4.300	4.700	0.169	0.185
D1	3.430		0.135	
E	4.300	4.700	0.169	0.185
e	1.270 TYP		0.050 TYP	
e1	2.440	2.640	0.096	0.104
L	14.100	14.500	0.555	0.571
Φ		1.600		0.063
h	0.000	0.380	0.000	0.015

TO-92 Suggested Pad Layout

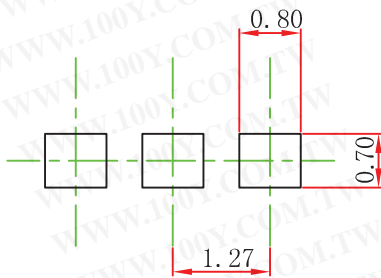

Note:

1. Controlling dimension: in millimeters.
2. General tolerance: $\pm 0.05\text{mm}$.
3. The pad layout is for reference purposes only.

NOTICE

JCET reserve the right to make modifications, enhancements, improvements, corrections or other changes without further notice to any product herein. JCET does not assume any liability arising out of the application or use of any product described herein.

TO-92 PACKAGE TAPEING DIMENSION

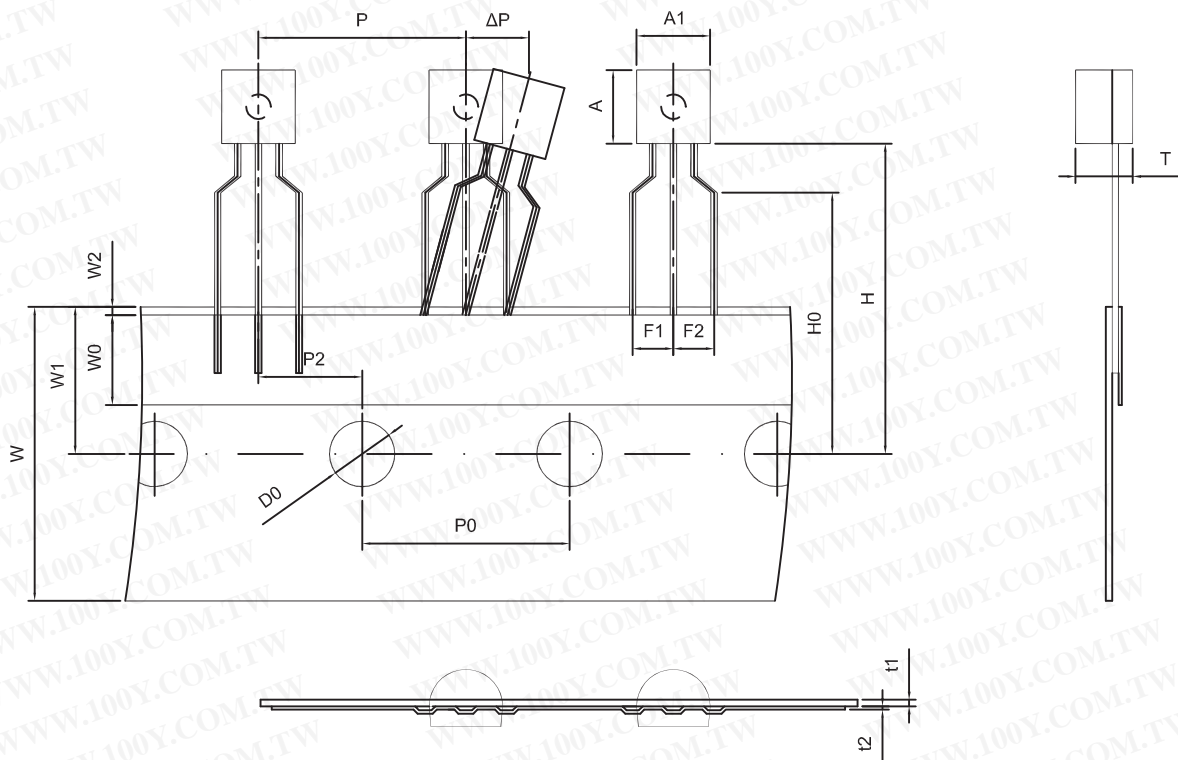

Dimiensions are in millimeter

A1	A	T	P	P0	P2	F1	F2	W
4.5	4.5	3.5	12.7	12.7	6.35	2.5	2.5	18.0
W0	W1	W2	H	H0	D0	t1	t2	ΔP
6.0	9.0	1.0 MAX.	19.0	16.0	4.0	0.4	0.2	0

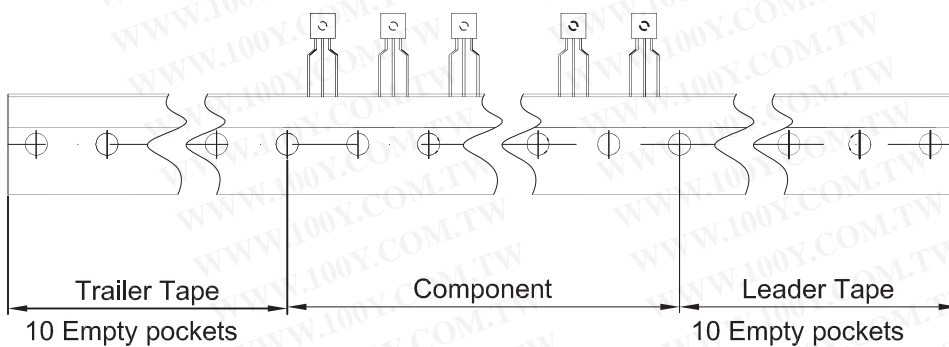

Package	Box	Box Size(mm)	Carton	Carton Size(mm)
TO-92	2000 pcs	333×162×43	20,000 pcs	350×340×250