

# 4V Drive Nch MOSFET

## RRS110N03

勝特力材料 886-3-5753170  
 勝特力电子(上海) 86-21-34970699  
 勝特力电子(深圳) 86-755-83298787  
[Http://www.100y.com.tw](http://www.100y.com.tw)

**●Structure**

Silicon N-channel MOSFET

**●Features**

- 1) Low on-resistance.
- 2) Built-in G-S Protection Diode.
- 3) Small Surface Mount Package (SOP8).

**●Applications**

Switching

**●Packaging specifications**

Type	Package	Taping
	Code	TB
	Basic ordering unit (pieces)	2500
RRS110N03		○

**●Dimensions (Unit : mm)**

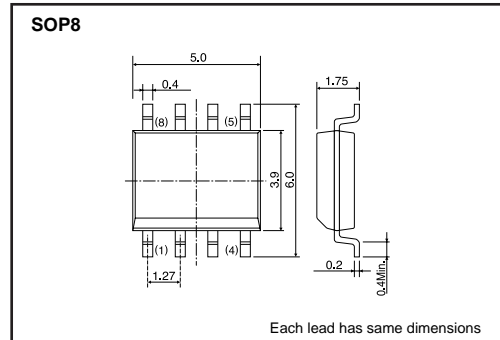

**●Equivalent circuit**

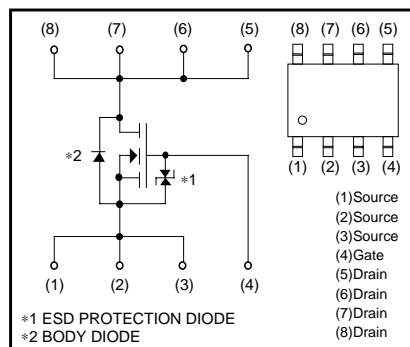

\*A protection diode is included between the gate and the source terminals to protect the diode against static electricity when the product is in use. Use the protection circuit when the fixed voltages are exceeded.

**●Absolute maximum ratings (Ta=25°C)**

Parameter	Symbol	Limits	Unit	
Drain-source voltage	V <sub>DSS</sub>	30	V	
Gate-source voltage	V <sub>GSS</sub>	±20	V	
Drain current	Continuous	I <sub>D</sub>	±11	A
	Pulsed	I <sub>DP</sub> *1	±44	A
Source current (Body diode)	Continuous	I <sub>S</sub>	1.6	A
	Pulsed	I <sub>SP</sub> *1	44	A
Total power dissipation	P <sub>D</sub> *2	2.0	W	
Channel temperature	T <sub>ch</sub>	150	°C	
Range of storage temperature	T <sub>stg</sub>	-55 to +150	°C	

\*1 Pw≤10μs, Duty cycle≤1%  
 \*2 Mounted on a ceramic board.

**●Thermal resistance**

Parameter	Symbol	Limits	Unit
Channel to ambient	R <sub>th (ch-a)</sub> *	62.5	°C / W

\* Mounted on a ceramic board.

## Transistor

## ●Electrical characteristics (Ta=25°C)

Parameter	Symbol	Min.	Typ.	Max.	Unit	Conditions
Gate-source leakage	$I_{GSS}$	–	–	±10	μA	$V_{GS}=\pm 20V, V_{DS}=0V$
Drain-source breakdown voltage	$V_{(BR)DSS}$	30	–	–	V	$I_D=1mA, V_{GS}=0V$
Zero gate voltage drain current	$I_{DSS}$	–	–	1	μA	$V_{DS}=30V, V_{GS}=0V$
Gate threshold voltage	$V_{GS(th)}$	1.0	–	2.5	V	$V_{DS}=10V, I_D=1mA$
Static drain-source on-starte resistance	$R_{DS(on)}$ *	–	9.0	12.6	mΩ	$I_D=11A, V_{GS}=10V$
		–	11.0	15.4		$I_D=11A, V_{GS}=4.5V$
		–	11.5	16.0		$I_D=11A, V_{GS}=4V$
Forward transfer admittance	$ Y_{fs} $ *	10	–	–	S	$I_D=11A, V_{DS}=10V$
Input capacitance	$C_{iss}$	–	2000	–	pF	$V_{DS}=10V$
Output capacitance	$C_{oss}$	–	330	–	pF	$V_{GS}=0V$
Reverse transfer capacitance	$C_{rss}$	–	280	–	pF	$f=1MHz$
Turn-on delay time	$t_{d(on)}$ *	–	16	–	ns	$I_D=5.5A, V_{DD}\doteq 15V$
Rise time	$t_r$ *	–	60	–	ns	$V_{GS}=10V$
Turn-off delay time	$t_{d(off)}$ *	–	80	–	ns	$R_L=2.73\Omega$
Fall time	$t_f$ *	–	100	–	ns	$R_G=10\Omega$
Total gate charge	$Q_g$ *	–	22.0	33.0	nC	$I_D=11A, V_{DD}\doteq 15V$
Gate-source charge	$Q_{gs}$ *	–	5.5	–	nC	$V_{GS}=5V$
Gate-drain charge	$Q_{gd}$ *	–	7.5	–	nC	$R_L=1.36\Omega, R_G=10\Omega$

\*Pulsed

## ●Body diode characteristics (Source-Drain) (Ta=25°C)

Parameter	Symbol	Min.	Typ.	Max.	Unit	Conditions
Forward voltage	$V_{SD}$ *	–	–	1.2	V	$I_S=11A, V_{GS}=0V$

\*Pulsed

Transistor

●Electrical characteristic curves

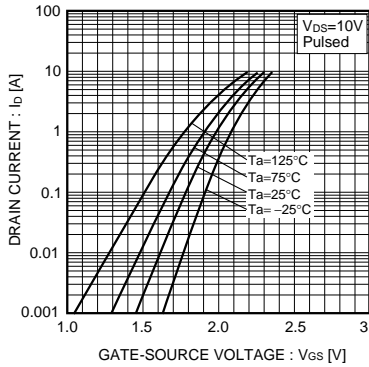

Fig.1 Typical Transfer Characteristics

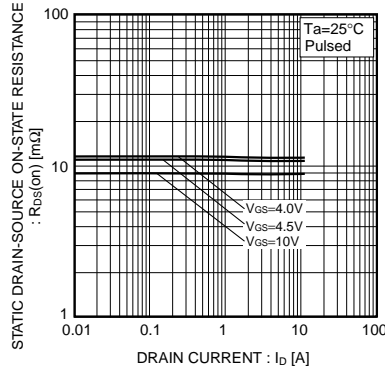

Fig.2 Static Drain-Source On-State Resistance vs. Drain Current(I)

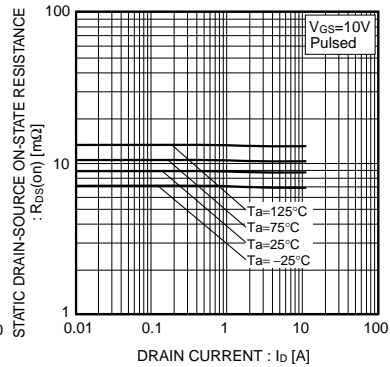

Fig.3 Static Drain-Source On-State Resistance vs. Drain Current(II)

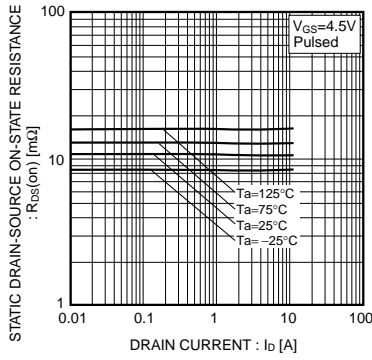

Fig.4 Static Drain-Source On-State Resistance vs. Drain Current(III)

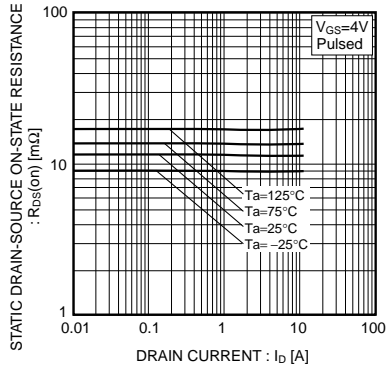

Fig.5 Static Drain-Source On-State Resistance vs. Drain Current(IV)

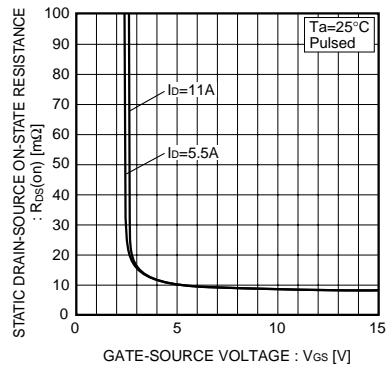

Fig.6 Static Drain-Source On-State Resistance vs. Gate-Source Voltage

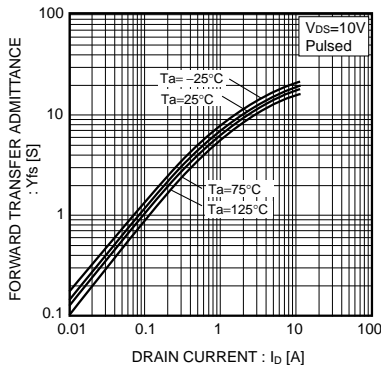

Fig.7 Forward Transfer Admittance vs. Drain Current

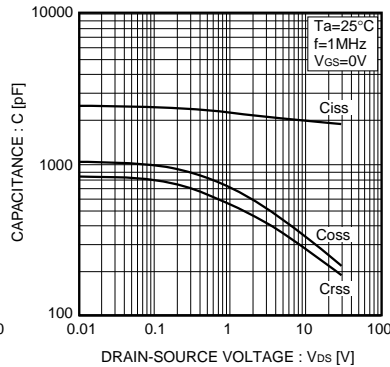

Fig.8 Typical Capacitance vs. Drain-Source Voltage

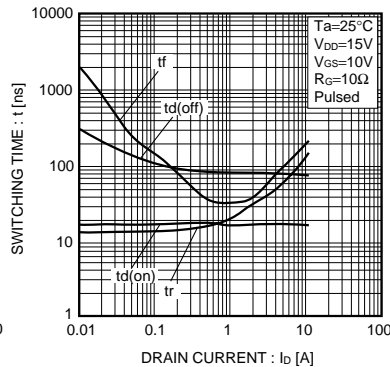

Fig.9 Switching Characteristics

Transistor

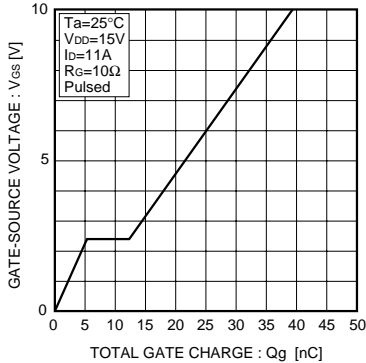

Fig.10 Dynamic Input Characteristics

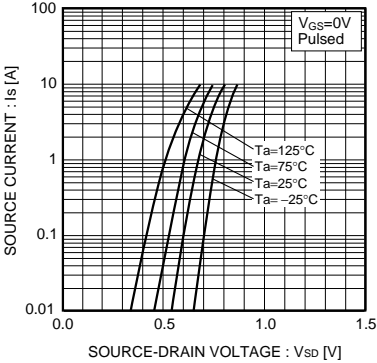

Fig.11 Source Current vs. Source-Drain Voltage

●Measurement circuit

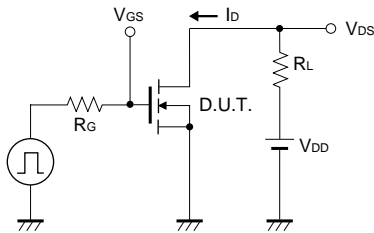

Fig.12 Switching Time Test Circuit

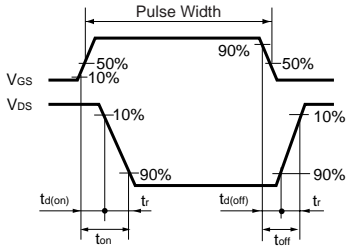

Fig.13 Switching Time Waveforms

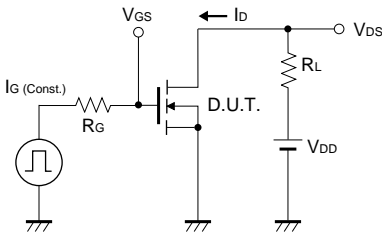

Fig.14 Gate Charge Test Circuit

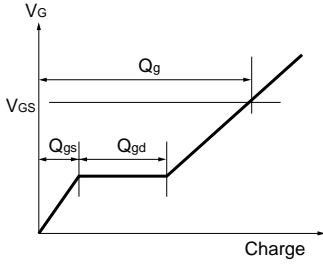

Fig.15 Gate Charge Waveform

### Notes

- No technical content pages of this document may be reproduced in any form or transmitted by any means without prior permission of ROHM CO.,LTD.
- The contents described herein are subject to change without notice. The specifications for the product described in this document are for reference only. Upon actual use, therefore, please request that specifications to be separately delivered.
- Application circuit diagrams and circuit constants contained herein are shown as examples of standard use and operation. Please pay careful attention to the peripheral conditions when designing circuits and deciding upon circuit constants in the set.
- Any data, including, but not limited to application circuit diagrams information, described herein are intended only as illustrations of such devices and not as the specifications for such devices. ROHM CO.,LTD. disclaims any warranty that any use of such devices shall be free from infringement of any third party's intellectual property rights or other proprietary rights, and further, assumes no liability of whatsoever nature in the event of any such infringement, or arising from or connected with or related to the use of such devices.
- Upon the sale of any such devices, other than for buyer's right to use such devices itself, resell or otherwise dispose of the same, no express or implied right or license to practice or commercially exploit any intellectual property rights or other proprietary rights owned or controlled by
- ROHM CO., LTD. is granted to any such buyer.
- Products listed in this document are no antiradiation design.

The products listed in this document are designed to be used with ordinary electronic equipment or devices (such as audio visual equipment, office-automation equipment, communications devices, electrical appliances and electronic toys).

Should you intend to use these products with equipment or devices which require an extremely high level of reliability and the malfunction of which would directly endanger human life (such as medical instruments, transportation equipment, aerospace machinery, nuclear-reactor controllers, fuel controllers and other safety devices), please be sure to consult with our sales representative in advance.

It is our top priority to supply products with the utmost quality and reliability. However, there is always a chance of failure due to unexpected factors. Therefore, please take into account the derating characteristics and allow for sufficient safety features, such as extra margin, anti-flammability, and fail-safe measures when designing in order to prevent possible accidents that may result in bodily harm or fire caused by component failure. ROHM cannot be held responsible for any damages arising from the use of the products under conditions out of the range of the specifications or due to non-compliance with the NOTES specified in this catalog.

Thank you for your accessing to ROHM product informations.

More detail product informations and catalogs are available, please contact your nearest sales office.

**ROHM** Customer Support System

THE AMERICAS / EUROPE / ASIA / JAPAN

[www.rohm.com](http://www.rohm.com)

Contact us : [webmaster@rohm.co.jp](mailto:webmaster@rohm.co.jp)