



勝特力材料 886-3-5753170  
勝特力电子(上海) 86-21-34970699  
勝特力电子(深圳) 86-755-83298787  
Http://www.100y.com.tw

## STN9260

### High voltage fast-switching PNP power transistor

#### Features

- High voltage capability
- Fast switching speed

#### Applications

- Lighting
- Switch mode power supply

#### Description

This device is a high voltage fast-switching PNP power transistor. It is manufactured using high voltage multi epitaxial planar technology for high switching speeds and medium voltage capability. It uses a cellular emitter structure with planar edge termination to enhance switching speeds while maintaining a wide RBSOA. The device is designed for use in lighting applications and low cost switch-mode power supplies.

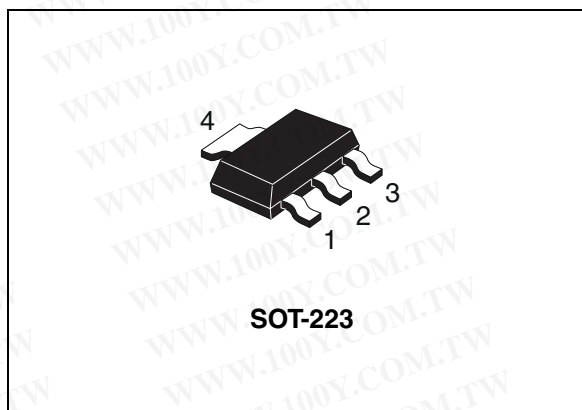

Figure 1. Internal schematic diagram

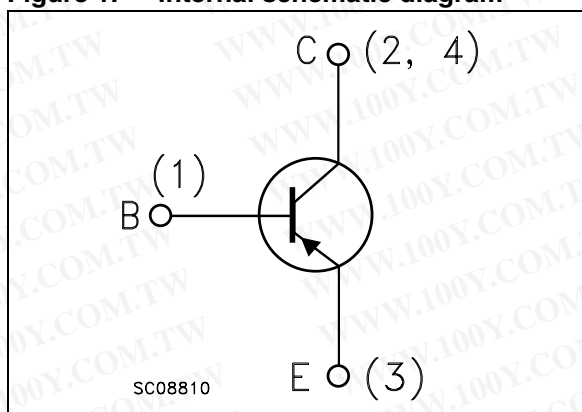

Table 1. Device summary

Part number	Marking	Package	Packaging
STN9260	N9260	SOT-223	Tape and reel

# 1 Electrical ratings

**Table 2. Absolute maximum ratings**

Symbol	Parameter	Value	Unit
$V_{CES}$	Collector-emitter voltage ( $V_{BE} = 0$ )	-600	V
$V_{CEO}$	Collector-emitter voltage ( $I_B = 0$ )	-600	V
$V_{EBO}$	Emitter-base voltage ( $I_C = 0$ )	-7	V
$I_C$	Collector current	-0.5	A
$I_{CM}$	Collector peak current ( $t_P < 5$ ms)	-1	A
$I_B$	Base current	-0.25	A
$I_{BM}$	Base peak current ( $t_P < 5$ ms)	-0.5	A
$P_{TOT}$	Total dissipation at $T_a = 25$ °C	1.6	W
$T_{STG}$	Storage temperature	-65 to 150	°C
$T_J$	Max. operating junction temperature	150	°C

**Table 3. Thermal data**

Symbol	Parameter	Value	Unit
$R_{thJA}$	Thermal resistance junction-ambient <sup>(1)</sup> max	78	°C/W

1. Device mounted on PCB area of 1 cm<sup>2</sup>.

## 2 Electrical characteristics

$T_{\text{case}} = 25\text{ °C}$  unless otherwise specified.

**Table 4. Electrical characteristics**

Symbol	Parameter	Test conditions	Min.	Typ.	Max.	Unit
$I_{\text{CES}}$	Collector cut-off current ( $V_{\text{BE}} = 0$ )	$V_{\text{CE}} = -600\text{ V}$			-10	$\mu\text{A}$
$I_{\text{EBO}}$	Emitter cut-off current ( $I_{\text{C}} = 0$ )	$V_{\text{EB}} = -7\text{ V}$			-1	$\mu\text{A}$
$V_{\text{CE(sus)}}^{(1)}$	Collector-emitter sustaining voltage ( $I_{\text{B}} = 0$ )	$I_{\text{C}} = -10\text{ mA}$	-600			V
$V_{\text{CE(sat)}}^{(1)}$	Collector-emitter saturation voltage	$I_{\text{C}} = -100\text{ mA}$ $I_{\text{B}} = -10\text{ mA}$			-1	V
$V_{\text{BE(sat)}}^{(1)}$	Base-emitter saturation voltage	$I_{\text{C}} = -100\text{ mA}$ $I_{\text{B}} = -10\text{ mA}$			-1	V
$h_{\text{FE}}$	DC current gain	$I_{\text{C}} = -10\text{ mA}$ $V_{\text{CE}} = -5\text{ V}$ $I_{\text{C}} = -20\text{ mA}$ $V_{\text{CE}} = -5\text{ V}$	50	140		
$t_{\text{r}}$	Resistive load Rise time	$V_{\text{CC}} = -200\text{ V}$ , $I_{\text{C}} = -0.1\text{ A}$		200		ns
$t_{\text{s}}$	Storage time	$I_{\text{B1}} = -10\text{ mA}$ , $I_{\text{B2}} = 20\text{ mA}$		3.2		$\mu\text{s}$
$t_{\text{f}}$	Fall time	$T_{\text{p}} = 30\text{ }\mu\text{s}$		150		ns

1. Pulse test: pulse duration  $\leq 300\text{ }\mu\text{s}$ , duty cycle  $\leq 2\%$ .

## 2.1 Electrical characteristics (curves)

Figure 2. Safe operating area

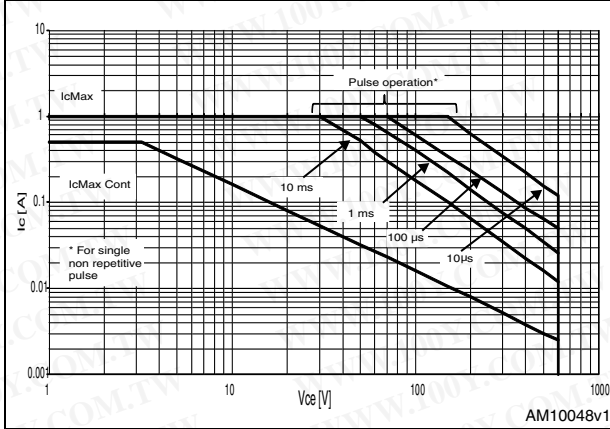

Figure 3. Derating curve



Figure 4. Output curves up to  $V_{CE} = -1$  V

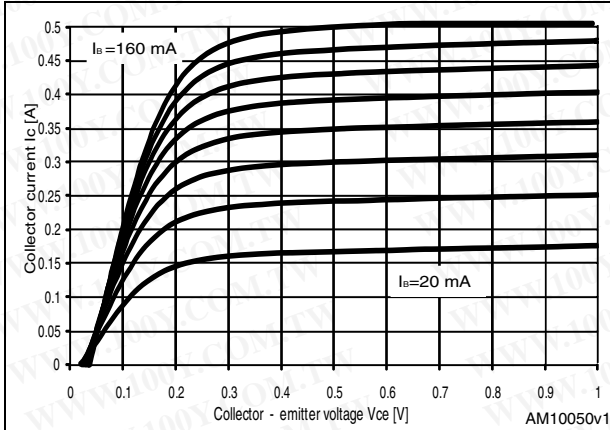

Figure 5. Output curves up to  $V_{CE} = -2$  V

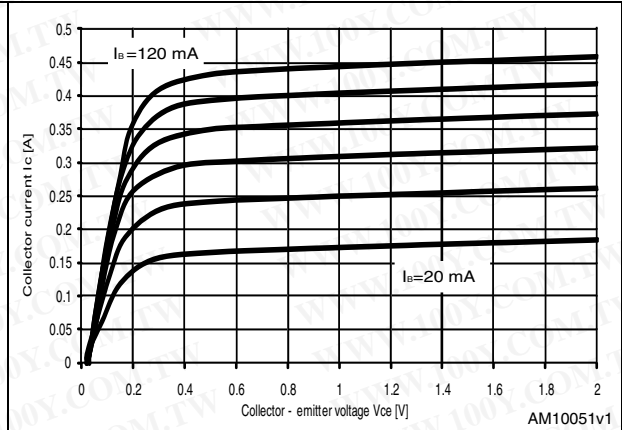

Figure 6. DC current gain ( $V_{CE} = -1$  V)

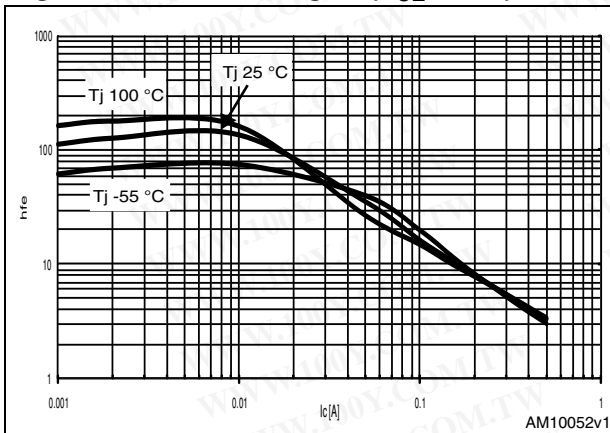

Figure 7. DC current gain ( $V_{CE} = -5$  V)

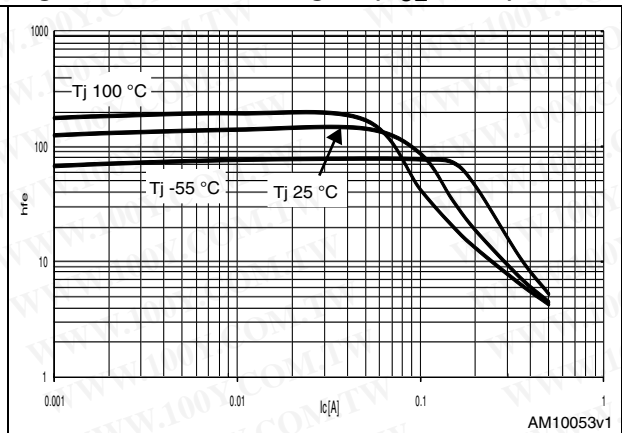

Figure 8. Collector-emitter saturation voltage Figure 9. Base-emitter saturation voltage

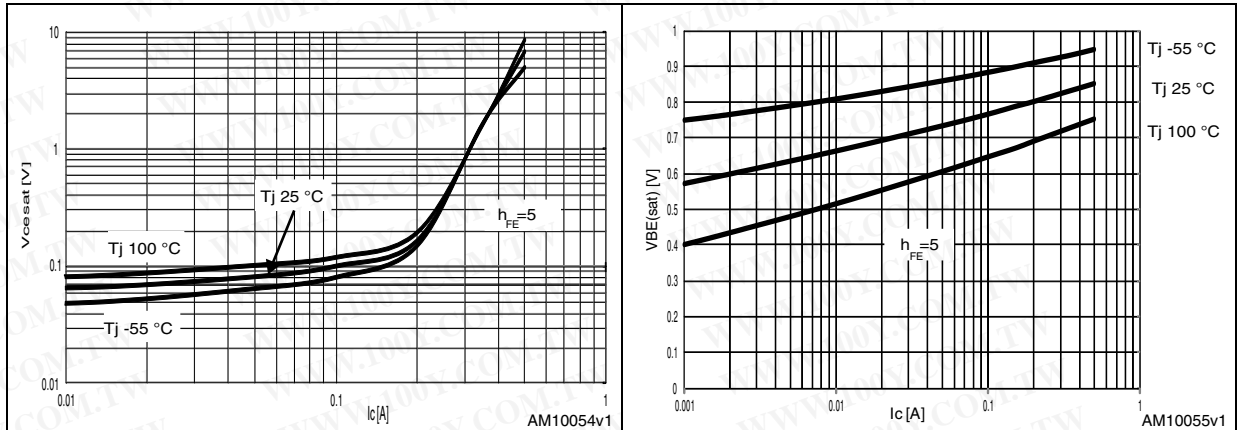

Figure 10. Base-emitter on voltage Figure 11. Capacitance variation

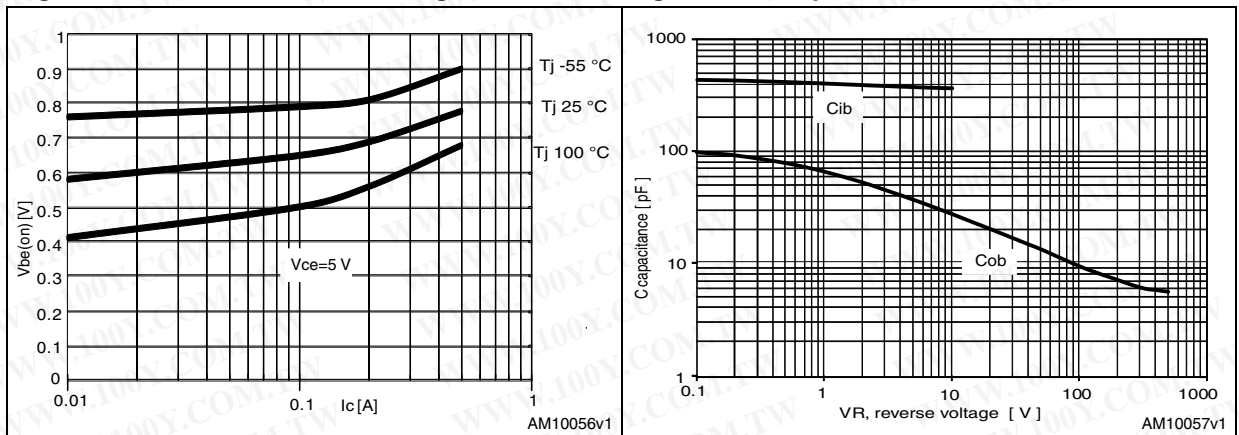
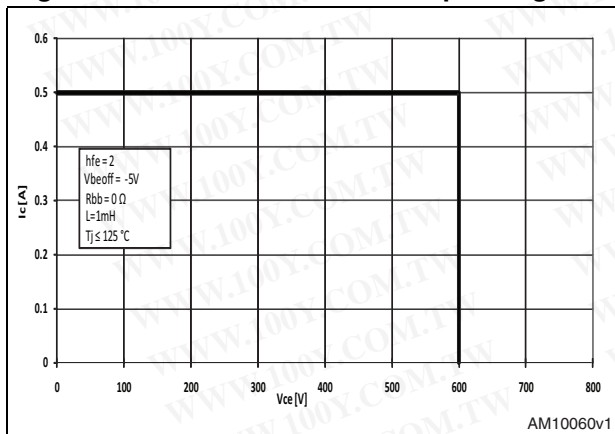

Figure 12. Reverse biased safe operating area





## 2.2 Test circuits

Figure 13. Resistive load switching test circuit

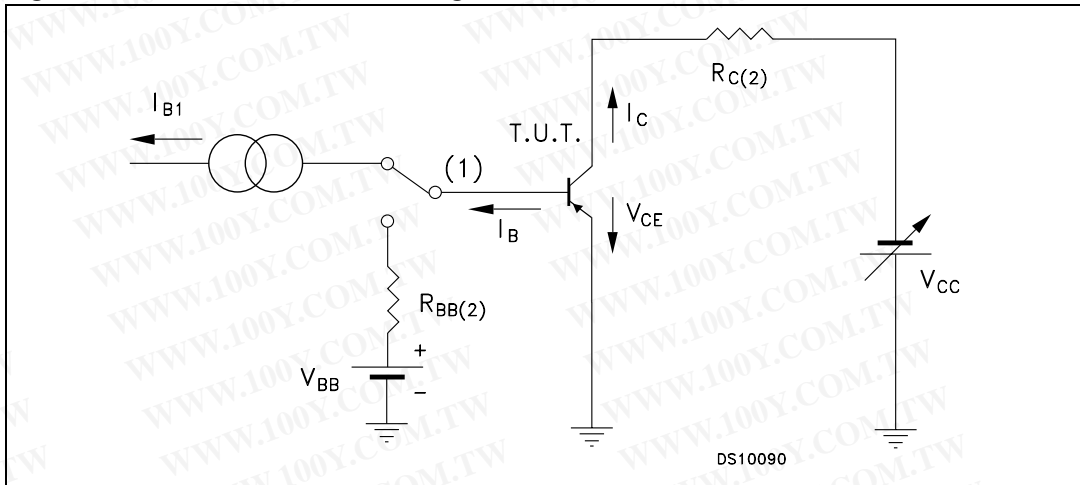

1. Fast electronic switching
2. Non-inductive resistor

### 3 Package mechanical data

In order to meet environmental requirements, ST offers these devices in different grades of ECOPACK® packages, depending on their level of environmental compliance. ECOPACK® specifications, grade definitions and product status are available at: [www.st.com](http://www.st.com). ECOPACK® is an ST trademark.

Dim.	mm		
	Min.	Typ.	Max.
A			1.80
A1	0.02		0.1
B	0.60	0.70	0.85
B1	2.90	3.00	3.15
c	0.24	0.26	0.35
D	6.30	6.50	6.70
e		2.30	
e1		4.60	
E	3.30	3.50	3.70
H	6.70	7.00	7.30
V			10°

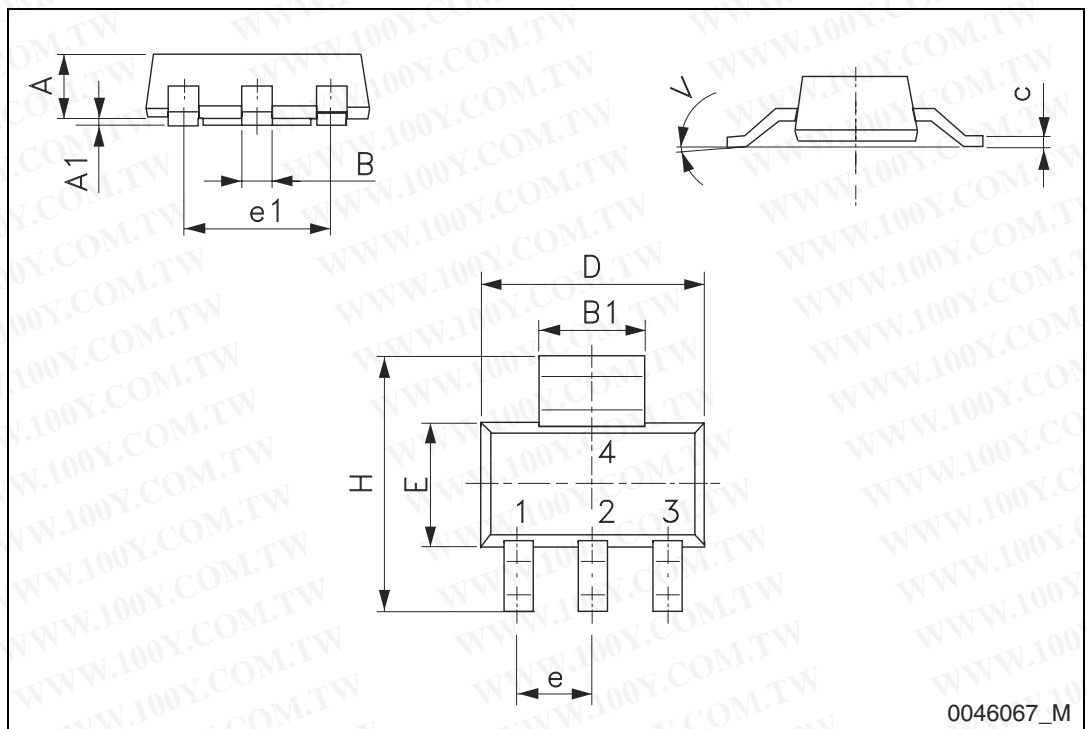

0046067\_M



## 4 Revision history

**Table 6. Document revision history**

Date	Revision	Changes
13-Dec-2010	1	Initial release.
03-Aug-2011	2	– Curves inserted – Minor text changes

勝特力材料 886-3-5753170  
勝特力电子(上海) 86-21-34970699  
勝特力电子(深圳) 86-755-83298787  
[Http://www.100y.com.tw](http://www.100y.com.tw)

**Please Read Carefully:**

Information in this document is provided solely in connection with ST products. STMicroelectronics NV and its subsidiaries ("ST") reserve the right to make changes, corrections, modifications or improvements, to this document, and the products and services described herein at any time, without notice.

All ST products are sold pursuant to ST's terms and conditions of sale.

Purchasers are solely responsible for the choice, selection and use of the ST products and services described herein, and ST assumes no liability whatsoever relating to the choice, selection or use of the ST products and services described herein.

No license, express or implied, by estoppel or otherwise, to any intellectual property rights is granted under this document. If any part of this document refers to any third party products or services it shall not be deemed a license grant by ST for the use of such third party products or services, or any intellectual property contained therein or considered as a warranty covering the use in any manner whatsoever of such third party products or services or any intellectual property contained therein.

**UNLESS OTHERWISE SET FORTH IN ST'S TERMS AND CONDITIONS OF SALE ST DISCLAIMS ANY EXPRESS OR IMPLIED WARRANTY WITH RESPECT TO THE USE AND/OR SALE OF ST PRODUCTS INCLUDING WITHOUT LIMITATION IMPLIED WARRANTIES OF MERCHANTABILITY, FITNESS FOR A PARTICULAR PURPOSE (AND THEIR EQUIVALENTS UNDER THE LAWS OF ANY JURISDICTION), OR INFRINGEMENT OF ANY PATENT, COPYRIGHT OR OTHER INTELLECTUAL PROPERTY RIGHT.**

**UNLESS EXPRESSLY APPROVED IN WRITING BY TWO AUTHORIZED ST REPRESENTATIVES, ST PRODUCTS ARE NOT RECOMMENDED, AUTHORIZED OR WARRANTED FOR USE IN MILITARY, AIR CRAFT, SPACE, LIFE SAVING, OR LIFE SUSTAINING APPLICATIONS, NOR IN PRODUCTS OR SYSTEMS WHERE FAILURE OR MALFUNCTION MAY RESULT IN PERSONAL INJURY, DEATH, OR SEVERE PROPERTY OR ENVIRONMENTAL DAMAGE. ST PRODUCTS WHICH ARE NOT SPECIFIED AS "AUTOMOTIVE GRADE" MAY ONLY BE USED IN AUTOMOTIVE APPLICATIONS AT USER'S OWN RISK.**

Resale of ST products with provisions different from the statements and/or technical features set forth in this document shall immediately void any warranty granted by ST for the ST product or service described herein and shall not create or extend in any manner whatsoever, any liability of ST.

ST and the ST logo are trademarks or registered trademarks of ST in various countries.

Information in this document supersedes and replaces all information previously supplied.

The ST logo is a registered trademark of STMicroelectronics. All other names are the property of their respective owners.

© 2011 STMicroelectronics - All rights reserved

STMicroelectronics group of companies

Australia - Belgium - Brazil - Canada - China - Czech Republic - Finland - France - Germany - Hong Kong - India - Israel - Italy - Japan - Malaysia - Malta - Morocco - Philippines - Singapore - Spain - Sweden - Switzerland - United Kingdom - United States of America

[www.st.com](http://www.st.com)