

## Dual N-Channel 30-V (D-S) MOSFET with Schottky Diode

PRODUCT SUMMARY			
	V <sub>DS</sub> (V)	r <sub>DS(on)</sub> (Ω)	I <sub>D</sub> (A)
Channel-1	30	0.023 at V <sub>GS</sub> = 10 V	7.0
		0.032 at V <sub>GS</sub> = 4.5 V	5.6
Channel-2		0.020 at V <sub>GS</sub> = 10 V	7.4
		0.027 at V <sub>GS</sub> = 4.5 V	6.4

SCHOTTKY PRODUCT SUMMARY		
V <sub>DS</sub> (V)	V <sub>SD</sub> (V) Diode Forward Voltage	I <sub>F</sub> (A)
30	0.40 V at 1.0 A	2.0

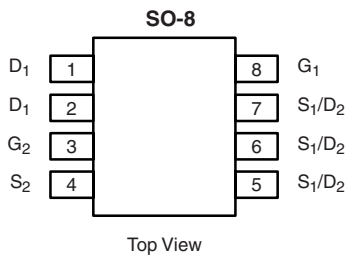

Ordering Information: Si4914DY-T1-E3 (Lead (Pb)-free)

### FEATURES

- LITTLE FOOT® Plus Integrated Schottky
- 100 % R<sub>G</sub> Tested



RoHS  
COMPLIANT

### APPLICATIONS

- Logic DC/DC
- Notebook PC

勝特力材料 886-3-5753170  
 勝特力电子(上海) 86-21-34970699  
 勝特力电子(深圳) 86-755-83298787  
[Http://www.100y.com.tw](http://www.100y.com.tw)

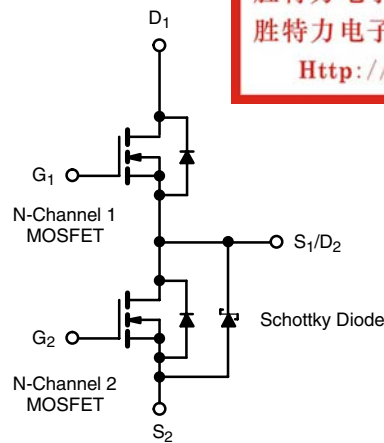

ABSOLUTE MAXIMUM RATINGS T <sub>A</sub> = 25 °C, unless otherwise noted							
Parameter	Symbol	Channel-1		Channel-2		Unit	
		10 sec	Steady State	10 sec	Steady State		
Drain-Source Voltage	V <sub>DS</sub>	30				V	
Gate-Source Voltage	V <sub>GS</sub>	20					
Continuous Drain Current (T <sub>J</sub> = 150 °C) <sup>a</sup>	I <sub>D</sub>	T <sub>A</sub> = 25 °C	7.0	5.5	7.4	5.7	A
		T <sub>A</sub> = 70 °C	5.6	4.3	6	4.5	
Pulsed Drain Current	I <sub>DM</sub>	40		40		A	
Continuous Source Current (Diode Conduction) <sup>a</sup>	I <sub>S</sub>	1.7	1.0	1.8	0.95		
Single Pulse Avalanche Current	I <sub>AS</sub>	L = 0.1 mH	13		15		mJ
Avalanche Energy			E <sub>AS</sub>	8.45		11	
Maximum Power Dissipation <sup>a</sup>	P <sub>D</sub>	T <sub>A</sub> = 25 °C	1.9	1.1	2.0	1.16	W
		T <sub>A</sub> = 70 °C	1.2	0.71	1.3	0.74	
Operating Junction and Storage Temperature Range	T <sub>J</sub> , T <sub>stg</sub>	- 55 to 150				°C	

THERMAL RESISTANCE RATINGS							
Parameter	Symbol	Channel-1		Channel-2		Unit	
		Typ	Max	Typ	Max		
Maximum Junction-to-Ambient <sup>a</sup>	R <sub>thJA</sub>	t ≤ 10 sec	52	65	47	60	°C/W
		Steady State	90	112	85	107	
Maximum Junction-to-Foot (Drain)	R <sub>thJF</sub>	30	38	28	35		

Notes:

a. Surface Mounted on 1" x 1" FR4 Board.

<b>MOSFET SPECIFICATIONS</b> $T_J = 25\text{ }^\circ\text{C}$ , unless otherwise noted							
Parameter	Symbol	Test Conditions		Min	Typ <sup>a</sup>	Max	Unit
<b>Static</b>							
Gate Threshold Voltage	$V_{GS(th)}$	$V_{DS} = V_{GS}$ , $I_D = 250\text{ }\mu\text{A}$	Ch-1	1.0		2.5	V
			Ch-2	1.0		2.5	
Gate-Body Leakage	$I_{GSS}$	$V_{DS} = 0\text{ V}$ , $V_{GS} = 20\text{ V}$	Ch-1			100	nA
			Ch-2			100	
Zero Gate Voltage Drain Current	$I_{DSS}$	$V_{DS} = 30\text{ V}$ , $V_{GS} = 0\text{ V}$	Ch-1			1	$\mu\text{A}$
			Ch-2			500	
		$V_{DS} = 30\text{ V}$ , $V_{GS} = 0\text{ V}$ , $T_J = 85\text{ }^\circ\text{C}$	Ch-1			0.015	mA
			Ch-2			20	
On-State Drain Current <sup>b</sup>	$I_{D(on)}$	$V_{DS} = 5\text{ V}$ , $V_{GS} = 10\text{ V}$	Ch-1	20			A
			Ch-2	20			
Drain-Source On-State Resistance <sup>b</sup>	$r_{DS(on)}$	$V_{GS} = 10\text{ V}$ , $I_D = 7.0\text{ A}$	Ch-1		0.019	0.023	$\Omega$
		$V_{GS} = 10\text{ V}$ , $I_D = 7.4\text{ A}$	Ch-2		0.016	0.020	
		$V_{GS} = 4.5\text{ V}$ , $I_D = 5.6\text{ A}$	Ch-1		0.026	0.032	
		$V_{GS} = 4.5\text{ V}$ , $I_D = 6.4\text{ A}$	Ch-2		0.022	0.027	
Forward Transconductance <sup>b</sup>	$g_{fs}$	$V_{DS} = 15\text{ V}$ , $I_D = 7.0\text{ A}$	Ch-1		19		S
		$V_{DS} = 15\text{ V}$ , $I_D = 7.4\text{ A}$	Ch-2		22		
Diode Forward Voltage <sup>b</sup>	$V_{SD}$	$I_S = 1.7\text{ A}$ , $V_{GS} = 0\text{ V}$	Ch-1		0.75	1.1	V
		$I_S = 1\text{ A}$ , $V_{GS} = 0\text{ V}$	Ch-2		0.36	0.40	
<b>Dynamic<sup>a</sup></b>							
Total Gate Charge	$Q_g$	Channel-1 $V_{DS} = 15\text{ V}$ , $V_{GS} = 4.5\text{ V}$ , $I_D = 7.0\text{ A}$	Ch-1		5.6	8.5	nC
			Ch-2		7.3	11	
Gate-Source Charge	$Q_{gs}$	Channel-2 $V_{DS} = 15\text{ V}$ , $V_{GS} = 4.5\text{ V}$ , $I_D = 7.4\text{ A}$	Ch-1		2.3		
			Ch-2		2.8		
Gate-Drain Charge	$Q_{gd}$	Channel-1 $V_{DS} = 15\text{ V}$ , $V_{GS} = 4.5\text{ V}$ , $I_D = 7.4\text{ A}$	Ch-1		1.7		
			Ch-2		2.2		
Gate Resistance	$R_g$	Channel-2 $V_{DS} = 15\text{ V}$ , $V_{GS} = 4.5\text{ V}$ , $I_D = 7.4\text{ A}$	Ch-1	0.5	2.3	3.6	$\Omega$
			Ch-2	0.5	1.6	2.5	
Turn-On Delay Time	$t_{d(on)}$	Channel-1 $V_{DD} = 15\text{ V}$ , $R_L = 15\text{ }\Omega$ $I_D \cong 1\text{ A}$ , $V_{GEN} = 10\text{ V}$ , $R_g = 6\text{ }\Omega$	Ch-1		6	10	ns
			Ch-2		7	11	
Rise Time	$t_r$	Channel-2 $V_{DD} = 15\text{ V}$ , $R_L = 15\text{ }\Omega$ $I_D \cong 1\text{ A}$ , $V_{GEN} = 10\text{ V}$ , $R_g = 6\text{ }\Omega$	Ch-1		13	20	
			Ch-2		13	20	
Turn-Off Delay Time	$t_{d(off)}$	Channel-1 $V_{DD} = 15\text{ V}$ , $R_L = 15\text{ }\Omega$ $I_D \cong 1\text{ A}$ , $V_{GEN} = 10\text{ V}$ , $R_g = 6\text{ }\Omega$	Ch-1		27	40	
			Ch-2		35	53	
Fall Time	$t_f$	Channel-2 $V_{DD} = 15\text{ V}$ , $R_L = 15\text{ }\Omega$ $I_D \cong 1\text{ A}$ , $V_{GEN} = 10\text{ V}$ , $R_g = 6\text{ }\Omega$	Ch-1		9	15	
			Ch-2		10	15	
Source-Drain Reverse Recovery Time	$t_{rr}$	$I_F = 1.3\text{ A}$ , $di/dt = 100\text{ A}/\mu\text{s}$	Ch-1		30	50	
		$I_F = 2.2\text{ A}$ , $di/dt = 100\text{ }\mu\text{A}/\mu\text{s}$	Ch-2		30	50	

Notes:

a. Guaranteed by design, not subject to production testing.

b. Pulse test; pulse width  $\leq 300\text{ }\mu\text{s}$ , duty cycle  $\leq 2\%$ .

<b>SCHOTTKY SPECIFICATIONS</b> $T_J = 25\text{ }^\circ\text{C}$ , unless otherwise noted							
Parameter	Symbol	Test Conditions		Min	Typ	Max	Unit
Forward Voltage Drop	$V_F$	$I_F = 1.0\text{ A}$			0.36	0.40	V
		$I_F = 1.0\text{ A}$ , $T_J = 150\text{ }^\circ\text{C}$			0.27	0.31	
Maximum Reverse Leakage Current	$I_{rm}$	$V_r = 30\text{ V}$			0.008	0.50	mA
		$V_r = 30\text{ V}$ , $T_J = 100\text{ }^\circ\text{C}$			3.5	10	
		$V_r = -30\text{ V}$ , $T_J = 125\text{ }^\circ\text{C}$			10	100	
Junction Capacitance	$C_T$	$V_r = 10\text{ V}$			58		pF

Stresses beyond those listed under "Absolute Maximum Ratings" may cause permanent damage to the device. These are stress ratings only, and functional operation of the device at these or any other conditions beyond those indicated in the operational sections of the specifications is not implied. Exposure to absolute maximum rating conditions for extended periods may affect device reliability.

## CHANNEL-1 TYPICAL CHARACTERISTICS 25 °C, unless noted

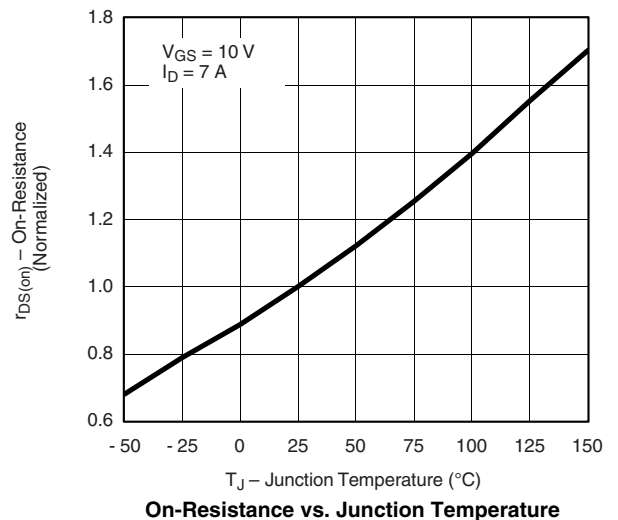
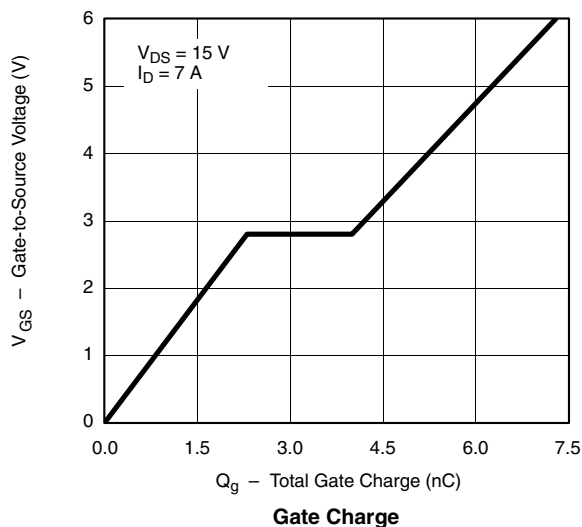
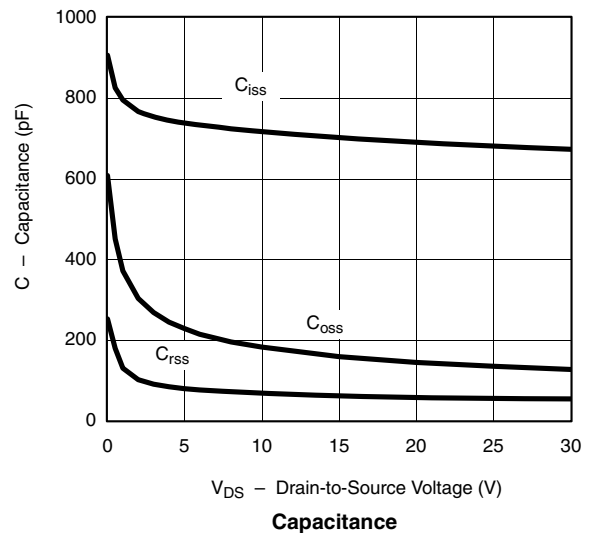
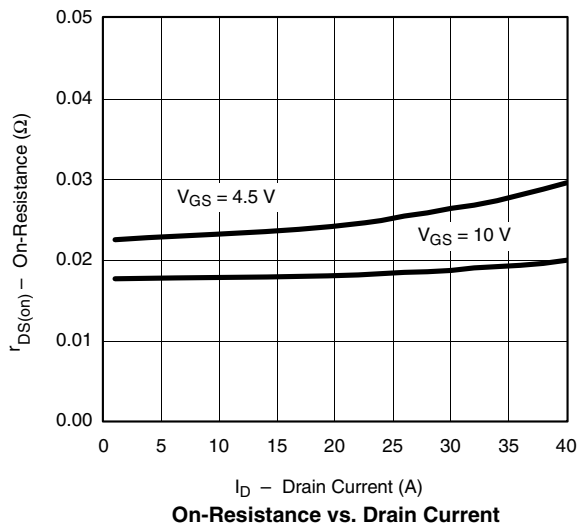
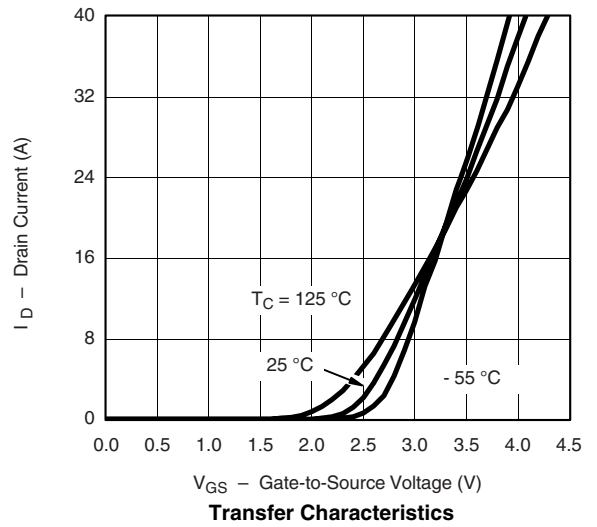
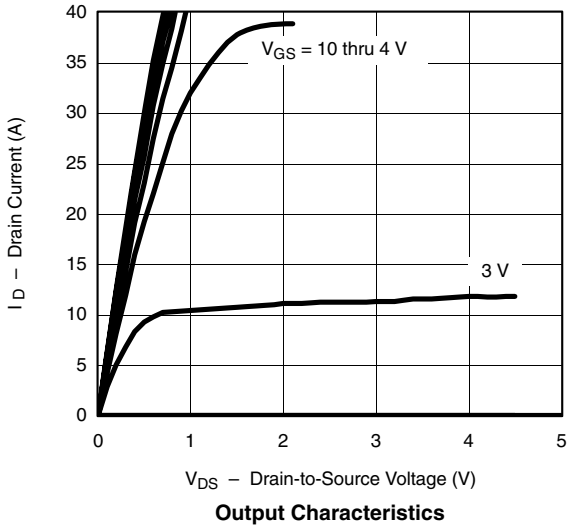

## CHANNEL-1 TYPICAL CHARACTERISTICS 25 °C, unless noted

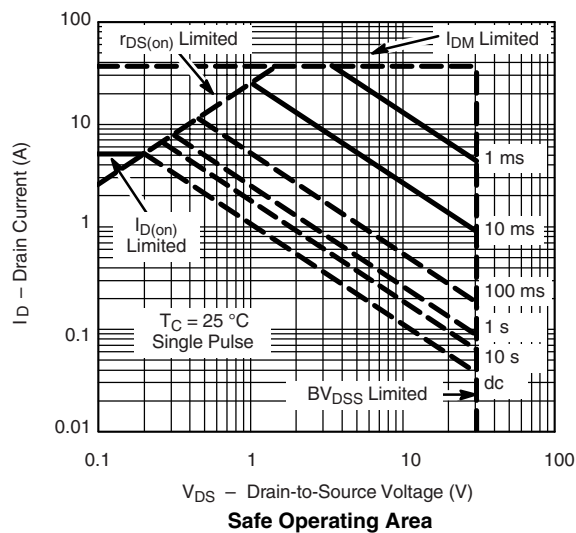
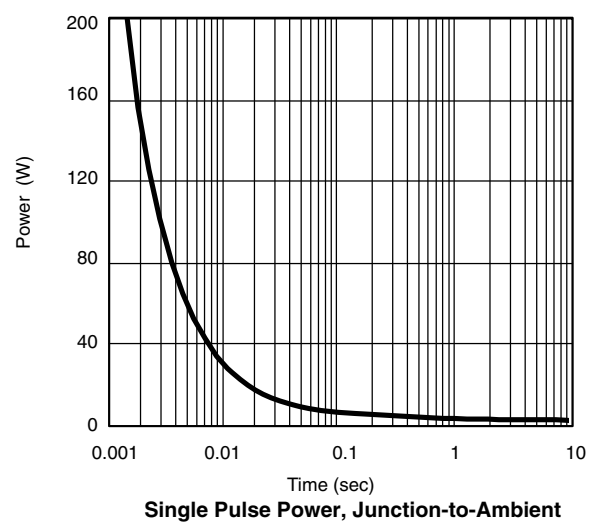
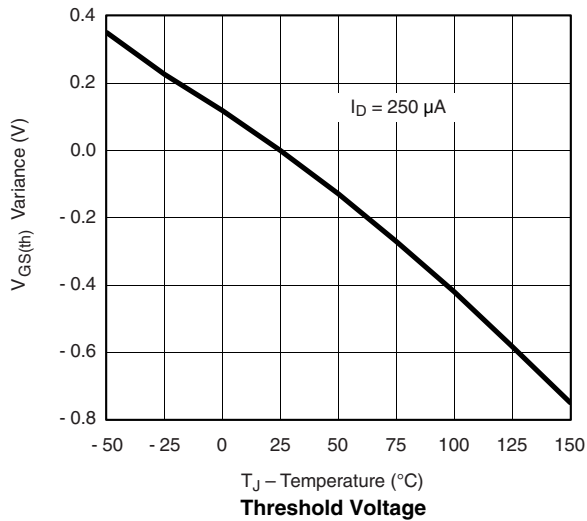
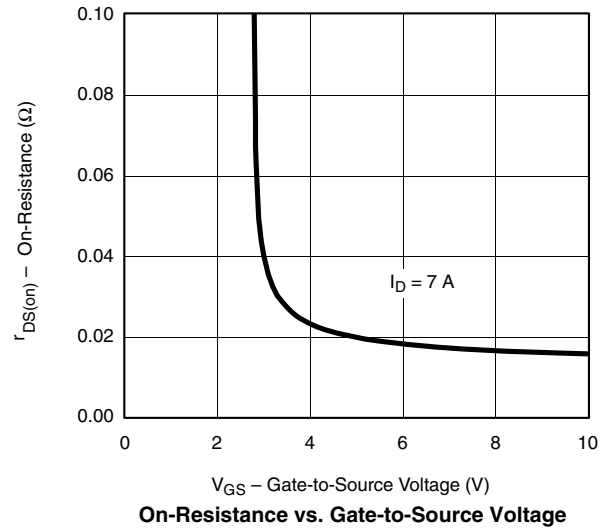
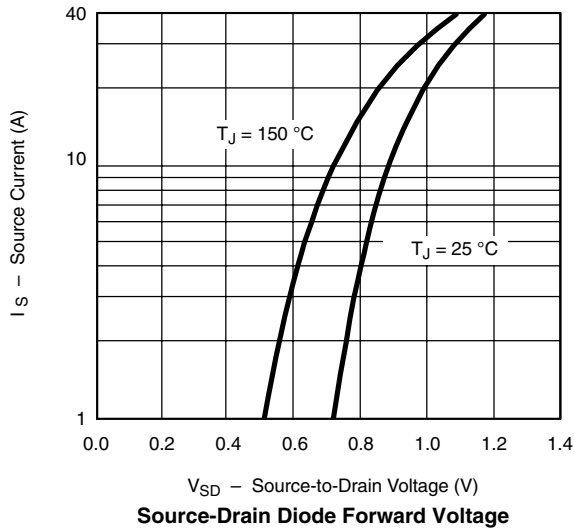

**CHANNEL-1 TYPICAL CHARACTERISTICS** 25 °C, unless noted

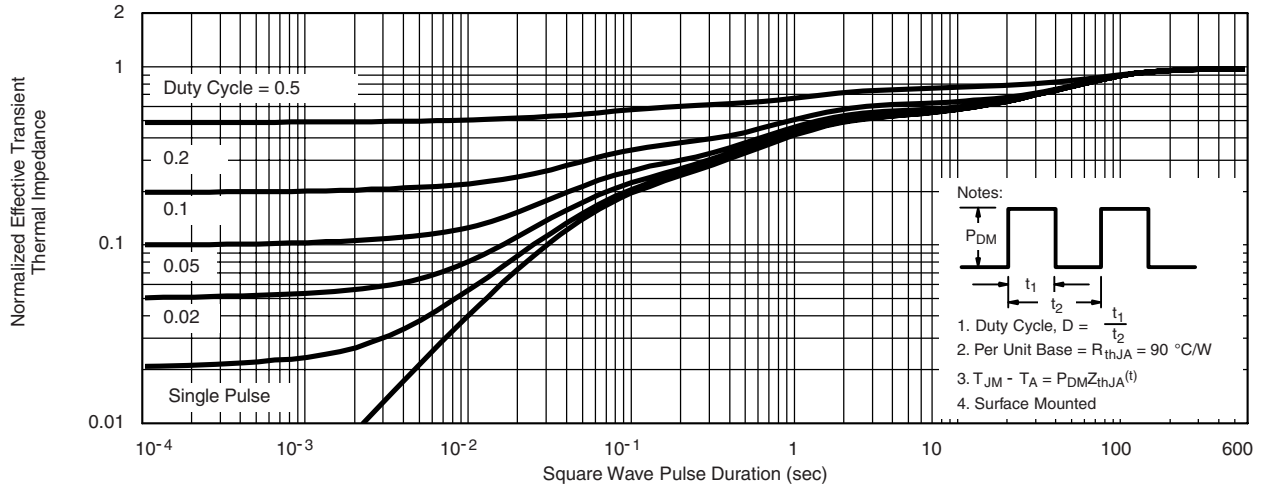

**Normalized Thermal Transient Impedance, Junction-to-Ambient**

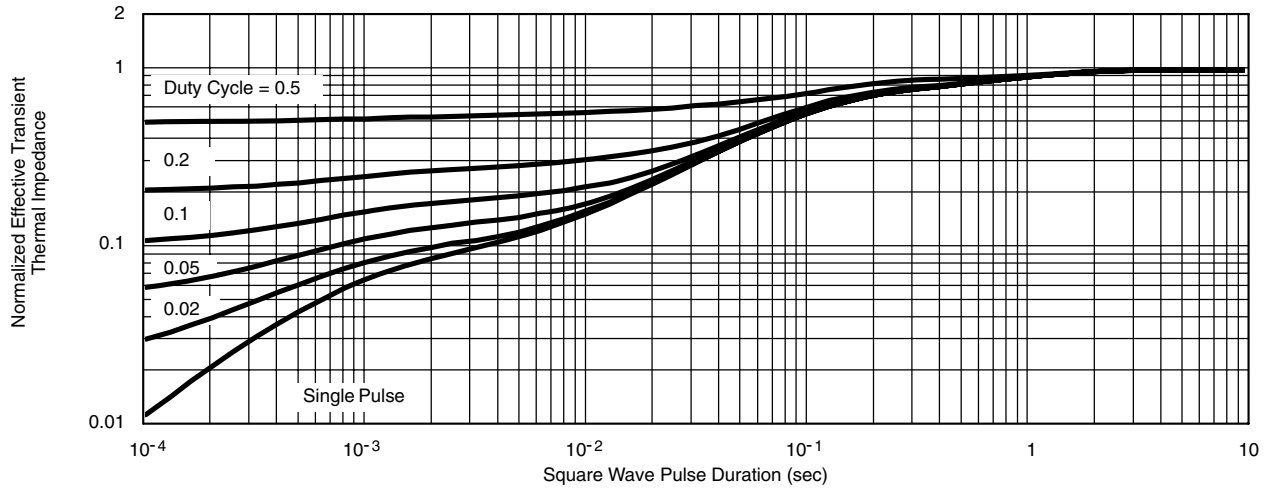

**Normalized Thermal Transient Impedance, Junction-to-Foot**

## CHANNEL-2 TYPICAL CHARACTERISTICS 25 °C, unless noted

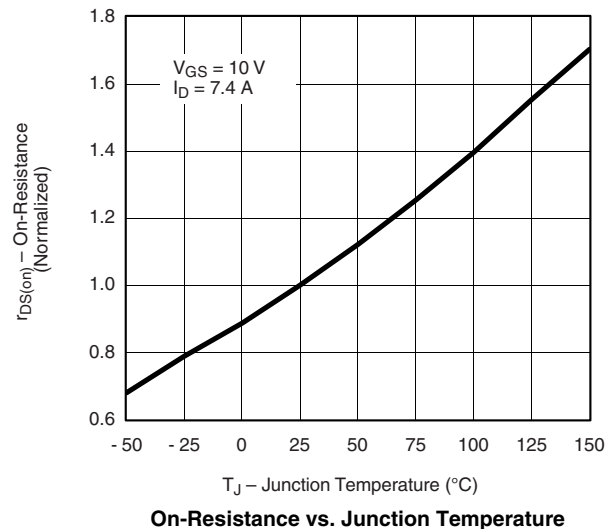
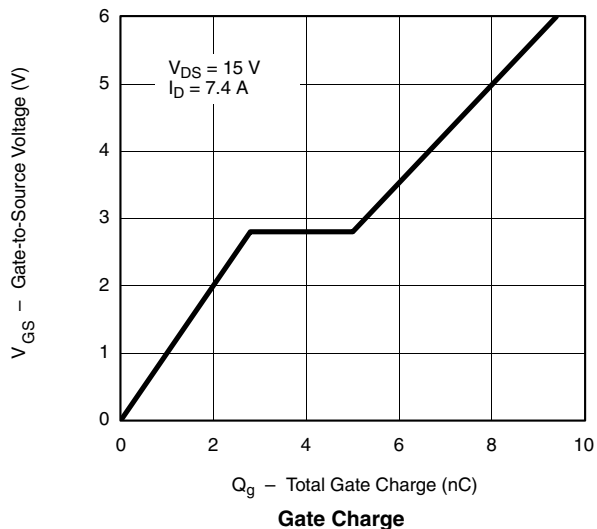
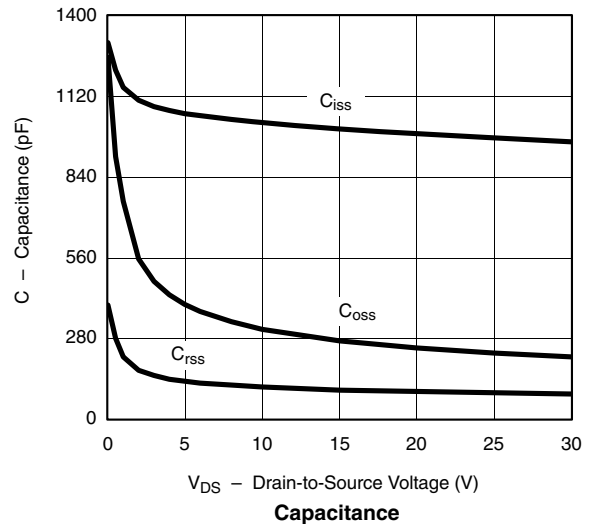
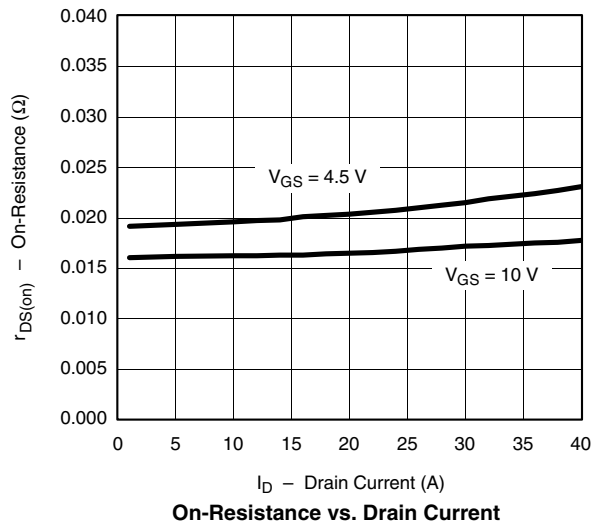
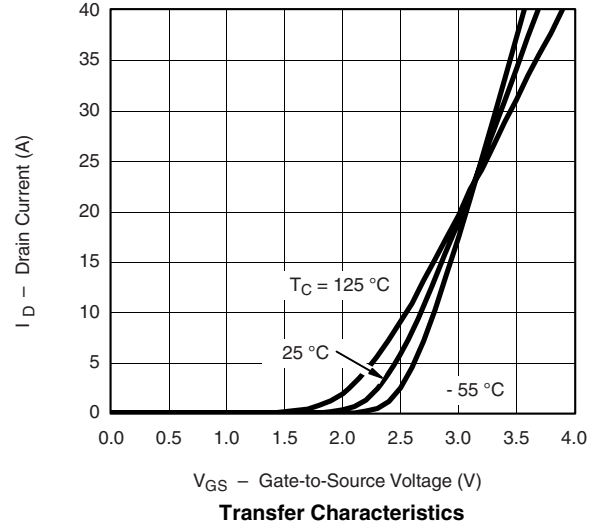
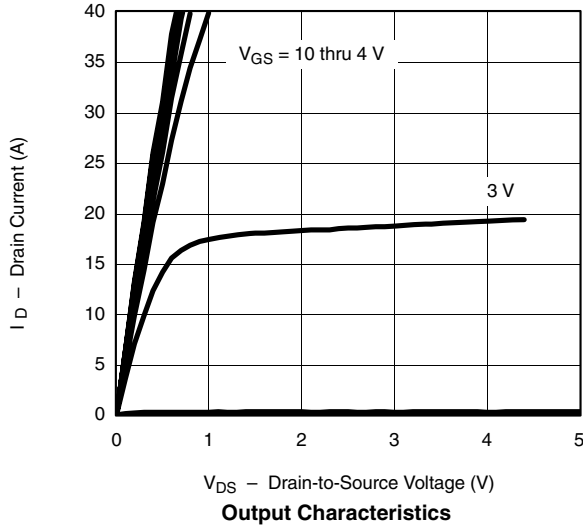

**CHANNEL-2 TYPICAL CHARACTERISTICS** 25 °C, unless noted

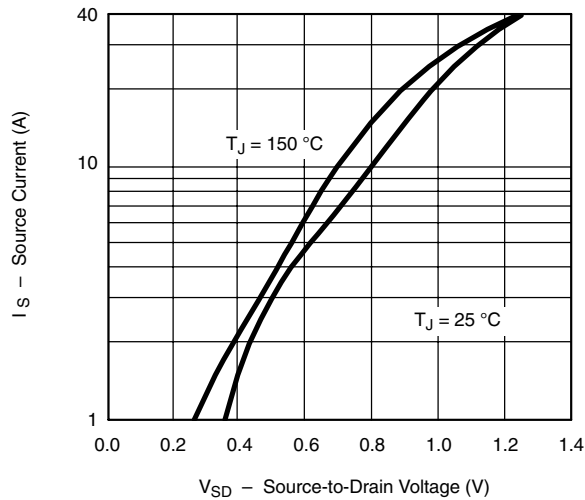

**Source-Drain Diode Forward Voltage**

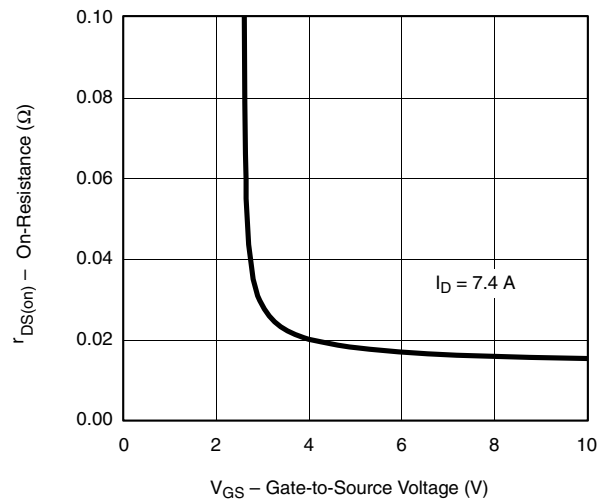

**On-Resistance vs. Gate-to-Source Voltage**

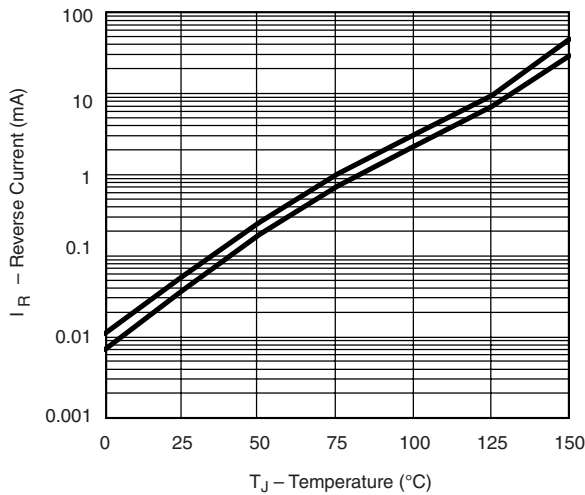

**Reverse Current vs. Junction Temperature**

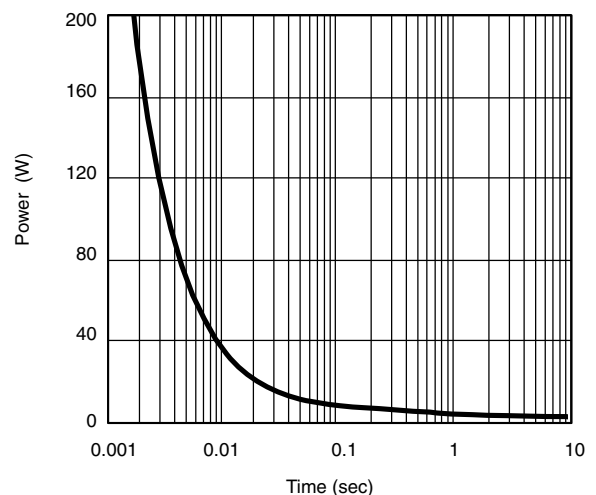

**Single Pulse Power, Junction-to-Ambient**

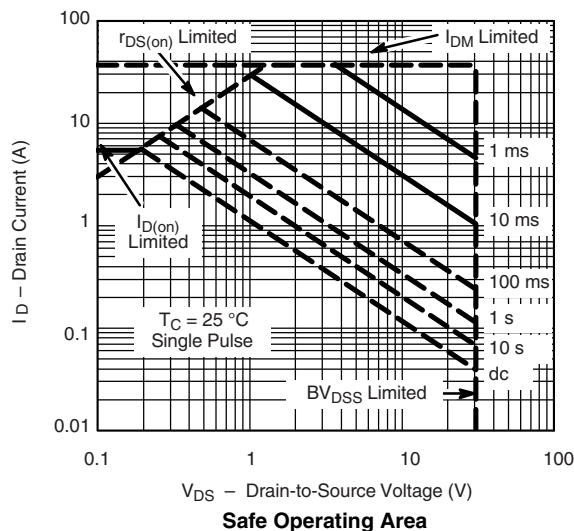

**Safe Operating Area**

**CHANNEL-2 TYPICAL CHARACTERISTICS** 25 °C, unless noted

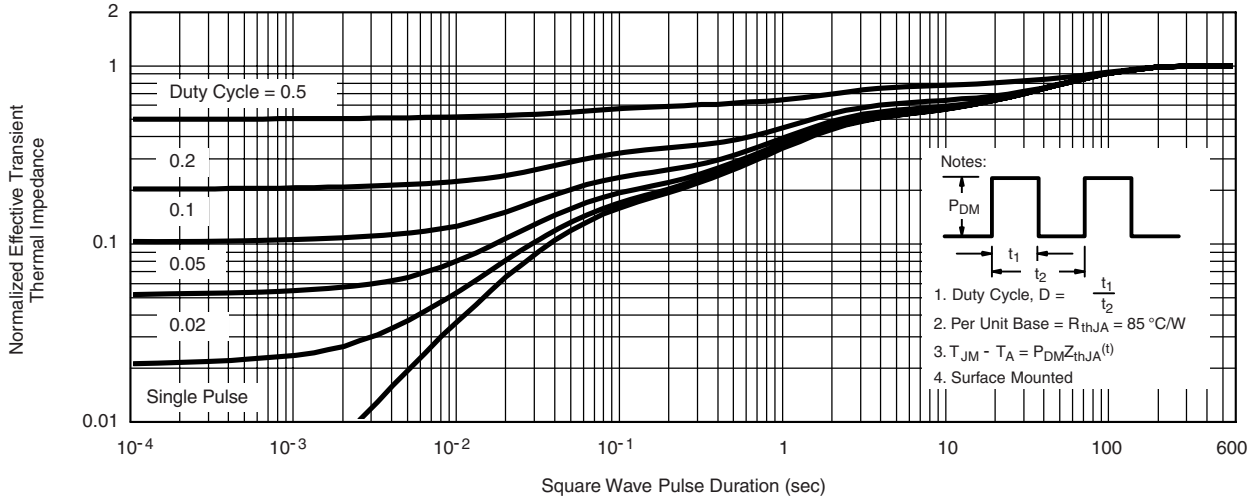

**Normalized Thermal Transient Impedance, Junction-to-Ambient**

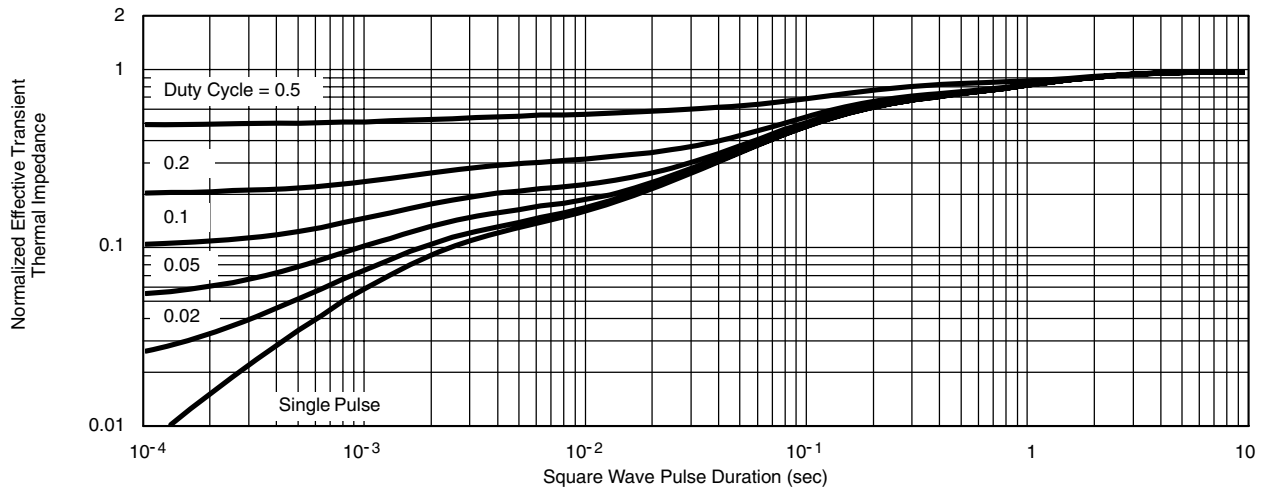

**Normalized Thermal Transient Impedance, Junction-to-Foot**

Vishay Siliconix maintains worldwide manufacturing capability. Products may be manufactured at one of several qualified locations. Reliability data for Silicon Technology and Package Reliability represent a composite of all qualified locations. For related documents such as package/tape drawings, part marking, and reliability data, see <http://www.vishay.com/ppg?72938>.





## Disclaimer

All product specifications and data are subject to change without notice.

Vishay Intertechnology, Inc., its affiliates, agents, and employees, and all persons acting on its or their behalf (collectively, "Vishay"), disclaim any and all liability for any errors, inaccuracies or incompleteness contained herein or in any other disclosure relating to any product.

Vishay disclaims any and all liability arising out of the use or application of any product described herein or of any information provided herein to the maximum extent permitted by law. The product specifications do not expand or otherwise modify Vishay's terms and conditions of purchase, including but not limited to the warranty expressed therein, which apply to these products.

No license, express or implied, by estoppel or otherwise, to any intellectual property rights is granted by this document or by any conduct of Vishay.

The products shown herein are not designed for use in medical, life-saving, or life-sustaining applications unless otherwise expressly indicated. Customers using or selling Vishay products not expressly indicated for use in such applications do so entirely at their own risk and agree to fully indemnify Vishay for any damages arising or resulting from such use or sale. Please contact authorized Vishay personnel to obtain written terms and conditions regarding products designed for such applications.

Product names and markings noted herein may be trademarks of their respective owners.