



### FEATURES

- Qualified for automotive applications
- Fully specified rail-to-rail at  $V_{CC} = 2.5\text{ V to }5.5\text{ V}$
- Input common-mode voltage:  $V_{EE} - 0.2\text{ V to }V_{CC} + 0.2\text{ V}$
- Low glitch TTL-/CMOS-compatible output stage
- 40 ns propagation delay
- Low power: 1.4 mW at 2.5 V
- Shutdown pin
- Programmable hysteresis
- Power supply rejection better than  $-50\text{ dB}$
- $-40^\circ\text{C to }+125^\circ\text{C}$  operation

### APPLICATIONS

- High speed instrumentation
- Clock and data signal restoration
- Logic level shifting or translation
- High speed line receivers
- Threshold detection
- Peak and zero-crossing detectors
- High speed trigger circuitry
- Pulse-width modulators
- Current/voltage controlled oscillators

勝特力材料 886-3-5753170  
 勝特力电子(上海) 86-21-34970699  
 勝特力电子(深圳) 86-755-83298787  
 Http://www.100y.com.tw

### GENERAL DESCRIPTION

The AD8469 is a fast comparator fabricated on XFCB2, an Analog Devices, Inc., proprietary process. This comparator is exceptionally versatile and easy to use. Features include an input range from  $V_{EE} - 0.2\text{ V to }V_{CC} + 0.2\text{ V}$ , low noise, TTL- and CMOS-compatible output drivers, adjustable hysteresis control, and a shutdown input. The device offers a 40 ns propagation delay driving a 15 pF load with 10 mV overdrive on 500  $\mu\text{A}$  typical supply current.

A flexible power supply scheme allows the device to operate from a single +2.5 V positive supply with a  $-0.2\text{ V to }+2.7\text{ V}$  input signal range up to a +5.5 V positive supply with a  $-0.2\text{ V to }+5.7\text{ V}$  input signal range.

The TTL-/CMOS-compatible output stage is designed to drive up to 15 pF with full rated timing specifications and to degrade in a graceful and linear fashion as additional capacitance is added. The input stage of the comparator offers robust protection against large input overdrive, and the outputs do not phase reverse when the valid input signal range is exceeded.

The AD8469 is available in an 8-lead MSOP package and features a shutdown pin and hysteresis control. It is fully specified over an operating temperature range of  $-40^\circ\text{C to }+125^\circ\text{C}$ .

### FUNCTIONAL BLOCK DIAGRAM

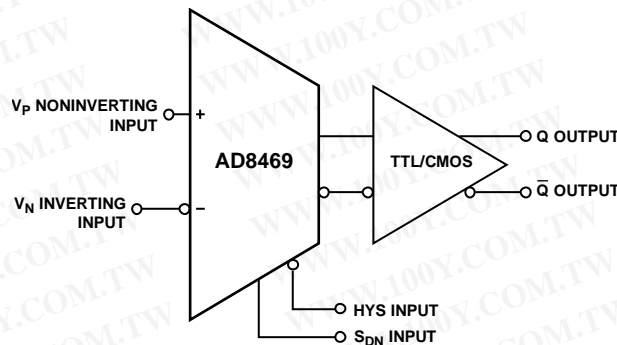

Figure 1.

### Rev. 0

Information furnished by Analog Devices is believed to be accurate and reliable. However, no responsibility is assumed by Analog Devices for its use, nor for any infringements of patents or other rights of third parties that may result from its use. Specifications subject to change without notice. No license is granted by implication or otherwise under any patent or patent rights of Analog Devices. Trademarks and registered trademarks are the property of their respective owners.

## TABLE OF CONTENTS

Features .....	1	Applications Information .....	8
Applications .....	1	Power/Ground Layout and Bypassing .....	8
General Description .....	1	TTL-/CMOS-Compatible Output Stage .....	8
Functional Block Diagram .....	1	Optimizing Performance .....	8
Revision History .....	2	Comparator Propagation Delay Dispersion .....	8
Specifications .....	3	Comparator Hysteresis .....	9
Electrical Characteristics .....	3	Crossover Bias Point .....	9
Absolute Maximum Ratings .....	4	Minimum Input Slew Rate Requirement .....	10
Thermal Resistance .....	4	Typical Applications Circuits .....	11
ESD Caution .....	4	Outline Dimensions .....	12
Pin Configuration and Function Descriptions .....	5	Ordering Guide .....	12
Typical Performance Characteristics .....	6	Automotive Products .....	12

## REVISION HISTORY

1/12—Revision 0: Initial Version

## SPECIFICATIONS

## ELECTRICAL CHARACTERISTICS

$V_{CC} = 2.5\text{ V}$ ,  $T_A = -40^\circ\text{C}$  to  $+125^\circ\text{C}$ , typical values at  $T_A = 25^\circ\text{C}$ , unless otherwise noted.

Table 1.

Parameter	Symbol	Test Conditions/Comments	Min	Typ	Max	Unit
<b>DC INPUT CHARACTERISTICS</b>						
Voltage Range	$V_P, V_N$	$V_{CC} = 2.5\text{ V to }5.5\text{ V}$	-0.2		$V_{CC} + 0.2$	V
Common-Mode Range	$V_{CM}$	$V_{CC} = 2.5\text{ V to }5.5\text{ V}$	-0.2		$V_{CC} + 0.2$	V
Differential Voltage		$V_{CC} = 2.5\text{ V to }5.5\text{ V}$			$V_{CC}$	V
Offset Voltage	$V_{OS}$		-5.0	±3	+5.0	mV
Bias Current	$I_P, I_N$		-0.4		+0.4	μA
Offset Current			-1.0		+1.0	μA
Capacitance	$C_P, C_N$			1		pF
Differential Mode Resistance		-0.5 V to $V_{CC} + 0.5\text{ V}$	200		7000	kΩ
Common-Mode Resistance		-0.5 V to $V_{CC} + 0.5\text{ V}$	100		4000	kΩ
Active Gain	$A_V$			80		dB
Common-Mode Rejection Ratio	CMRR	$V_{CM} = -0.2\text{ V to }+2.7\text{ V}, V_{CC} = 2.5\text{ V}$	50			dB
		$V_{CM} = -0.2\text{ V to }+2.7\text{ V}, V_{CC} = 5.5\text{ V}$	50			dB
Hysteresis		$R_{HYS} = \infty$		0.1		mV
<b>HYSTERESIS MODE AND TIMING</b>						
Hysteresis Mode Bias Voltage		Current = 1 μA	1.145	1.25	1.35	V
Minimum Resistor Value		Hysteresis = 120 mV	30		120	kΩ
<b>SHUTDOWN PIN CHARACTERISTICS<sup>1</sup></b>						
Input Voltage High	$V_{IH}$	Comparator is operating	2.0		$V_{CC}$	V
Input Voltage Low	$V_{IL}$	Shutdown guaranteed	-0.2		+0.4	V
Input Current High	$I_{IH}$	$V_{IH} = V_{CC}$	-6		+6	μA
Sleep Time	$t_{SD}$	$I_{CC} < 100\text{ μA}$		300		ns
Wake-Up Time	$t_H$	$V_P = 10\text{ mV}$ , output valid		150		ns
<b>DC OUTPUT CHARACTERISTICS</b>						
Output Voltage High	$V_{OH}$	$V_{CC} = 2.5\text{ V}$ $I_{OH} = 0.8\text{ mA}$	$V_{CC} - 0.4$			V
Output Voltage Low	$V_{OL}$	$I_{OL} = 0.8\text{ mA}$			0.4	V
<b>AC PERFORMANCE<sup>2</sup></b>						
Rise Time/Fall Time	$t_R/t_F$	10% to 90%, $V_{CC} = 2.5\text{ V}$		25 to 50		ns
		10% to 90%, $V_{CC} = 5.5\text{ V}$		45 to 75		ns
Propagation Delay	$t_{PD}$	$V_{OD} = 10\text{ mV}, V_{CC} = 2.5\text{ V}$		30 to 50		ns
		$V_{OD} = 50\text{ mV}, V_{CC} = 5.5\text{ V}$		35 to 60		ns
Propagation Delay Skew						
Rising-to-Falling Transition		$V_{CC} = 2.5\text{ V}$		4.5		ns
		$V_{CC} = 5.5\text{ V}$		8		ns
Q to $\bar{Q}$		$V_{CC} = 2.5\text{ V}$		3		ns
		$V_{CC} = 5.5\text{ V}$		4		ns
Overdrive Dispersion		$10\text{ mV} < V_{OD} < 125\text{ mV}$		12		ns
Common-Mode Dispersion		$-0.2\text{ V} < V_{CM} < V_{CC} + 0.2\text{ V}$		1.5		ns
<b>POWER SUPPLY</b>						
Supply Voltage Range	$V_{CC}$		2.5		5.5	V
Positive Supply Current	$I_{VCC}$	$V_{CC} = 2.5\text{ V}$		550	650	μA
		$V_{CC} = 5.5\text{ V}$		800	1100	μA
Power Dissipation	$P_D$	$V_{CC} = 2.5\text{ V}$		1.4	1.7	mW
		$V_{CC} = 5.5\text{ V}$		4.5	7	mW
Power Supply Rejection Ratio	PSRR	$V_{CC} = 2.5\text{ V to }5.5\text{ V}$	-50			dB
Shutdown Current	$I_{SD}$	$V_{CC} = 2.5\text{ V to }5.5\text{ V}$		150	260	μA

<sup>1</sup> The output is high impedance when the device is in shutdown mode. Note that this feature must be used with care because the enable/disable time is much longer than with a true tristate output.

<sup>2</sup>  $V_{IN} = 100\text{ mV}$  square input at 1 MHz,  $V_{CM} = 0\text{ V}$ ,  $C_L = 15\text{ pF}$ ,  $V_{CC} = 2.5\text{ V}$ , unless otherwise noted.

## ABSOLUTE MAXIMUM RATINGS

Table 2.

Parameter	Rating
Supply Voltages, $V_{CC}$ and $V_{EE}$	
$V_{CC}$ to Ground	−0.5 V to +6.0 V
Differential Supply Voltage	−6.0 V to +6.0 V
Analog Inputs, $V_P$ and $V_N$	
Input Voltage	−0.5 V to $V_{CC} + 0.5$ V
Differential Input Voltage	$\pm(V_{CC} + 0.5$ V)
Maximum Input/Output Current	$\pm 50$ mA
Shutdown Pin, $S_{DN}$	
Applied Voltage ( $S_{DN}$ to Ground)	−0.5 V to $V_{CC} + 0.5$ V
Maximum Input/Output Current	$\pm 50$ mA
Hysteresis Control Pin, HYS	
Applied Voltage (HYS to Ground)	−0.5 V to $V_{CC} + 0.5$ V
Maximum Input/Output Current	$\pm 50$ mA
Output Current, $Q$ and $\bar{Q}$	$\pm 50$ mA
Operating Temperature	
Ambient Temperature Range	−40°C to +125°C
Junction Temperature	150°C

Stresses above those listed under Absolute Maximum Ratings may cause permanent damage to the device. This is a stress rating only; functional operation of the device at these or any other conditions above those indicated in the operational section of this specification is not implied. Exposure to absolute maximum rating conditions for extended periods may affect device reliability.

## THERMAL RESISTANCE

$\theta_{JA}$  is specified for the worst-case conditions, that is, a device soldered in a circuit board for surface-mount packages.

Table 3.

Package Type	$\theta_{JA}$ <sup>1</sup>	Unit
8-Lead MSOP (RM-8)	130	°C/W

<sup>1</sup> Measurement in still air.

## ESD CAUTION



### ESD (electrostatic discharge) sensitive device.

Charged devices and circuit boards can discharge without detection. Although this product features patented or proprietary protection circuitry, damage may occur on devices subjected to high energy ESD. Therefore, proper ESD precautions should be taken to avoid performance degradation or loss of functionality.

## PIN CONFIGURATION AND FUNCTION DESCRIPTIONS

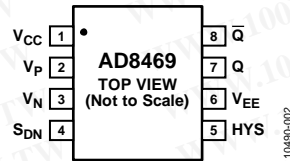

Figure 2. Pin Configuration

Table 4. Pin Function Descriptions

Pin No.	Mnemonic	Description
1	V <sub>CC</sub>	Positive Supply Voltage.
2	V <sub>P</sub>	Noninverting Analog Input.
3	V <sub>N</sub>	Inverting Analog Input.
4	S <sub>DN</sub>	Shutdown. Drive this pin low to shut down the device.
5	HYS	Hysteresis Control. Bias this pin with a resistor or current source for hysteresis.
6	V <sub>EE</sub>	Negative Supply Voltage.
7	Q	Noninverting Output. In compare mode, Q is at logic high if the analog voltage at the noninverting input (V <sub>P</sub> ) is greater than the analog voltage at the inverting input (V <sub>N</sub> ).
8	$\bar{Q}$	Inverting Output. In compare mode, $\bar{Q}$ is at logic low if the analog voltage at the noninverting input (V <sub>P</sub> ) is greater than the analog voltage at the inverting input (V <sub>N</sub> ).

TYPICAL PERFORMANCE CHARACTERISTICS

$V_{CC} = 2.5\text{ V}$ ,  $T_A = 25^\circ\text{C}$ , unless otherwise noted.

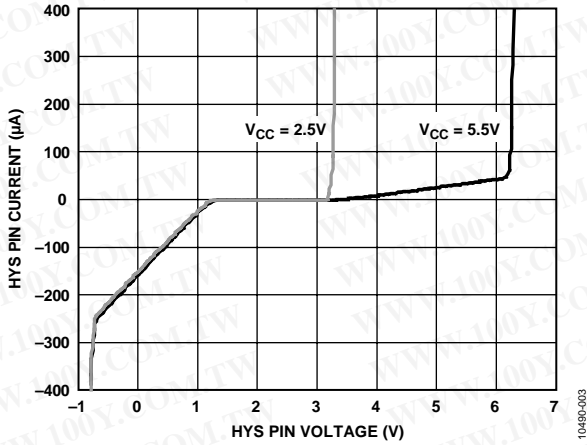

Figure 3. HYS Pin Current vs. Voltage,  $V_{CC} = 2.5\text{ V}$  and  $5.5\text{ V}$

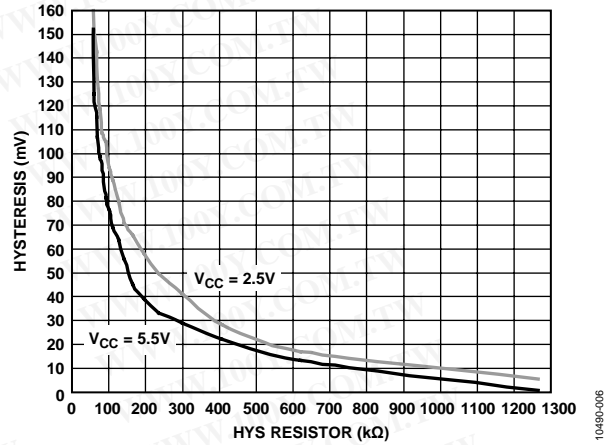

Figure 6. Hysteresis vs. HYS Resistor,  $V_{CC} = 2.5\text{ V}$  and  $5.5\text{ V}$

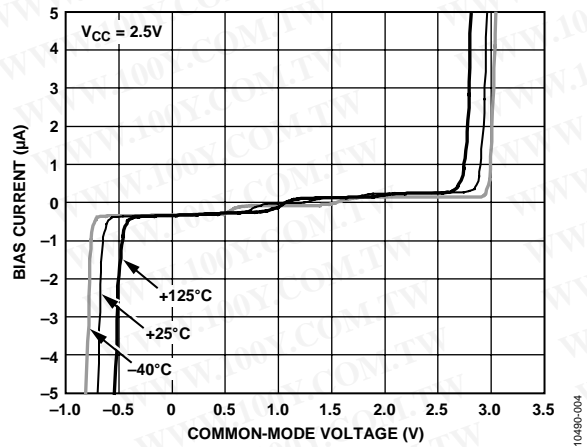

Figure 4. Input Bias Current vs. Input Common-Mode Voltage,  $V_{CC} = 2.5\text{ V}$

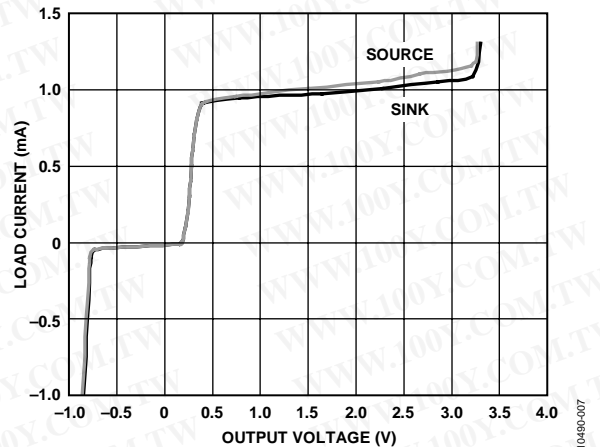

Figure 7. Load Current vs. Output Voltage

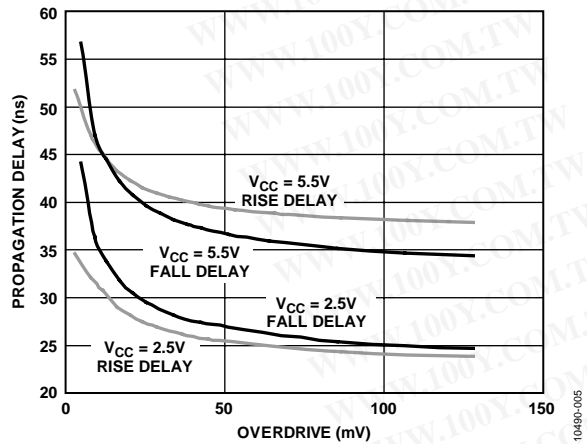

Figure 5. Propagation Delay vs. Input Overdrive,  $V_{CC} = 2.5\text{ V}$  and  $5.5\text{ V}$

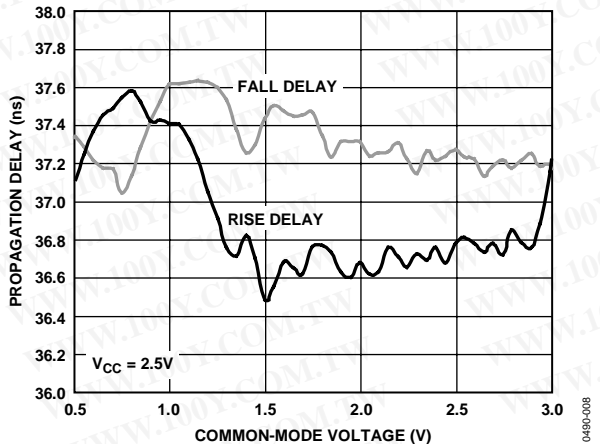

Figure 8. Propagation Delay vs. Input Common-Mode Voltage,  $V_{CC} = 2.5\text{ V}$

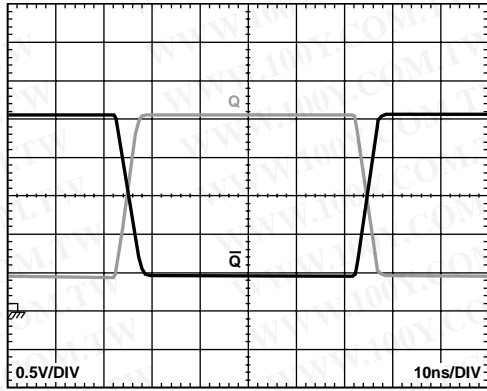

Figure 9. 1 MHz Output Voltage Waveform,  $V_{CC} = 2.5\text{ V}$

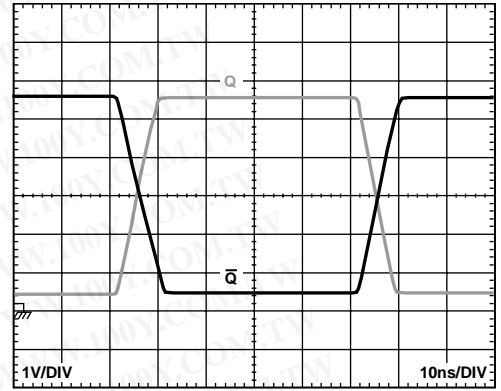

Figure 10. 1 MHz Output Voltage Waveform,  $V_{CC} = 5.5\text{ V}$



## APPLICATIONS INFORMATION

### POWER/GROUND LAYOUT AND BYPASSING

The AD8469 comparator is a high speed device. Despite the low noise output stage, it is essential to use proper high speed design techniques to achieve the specified performance. Because comparators are uncompensated amplifiers, feedback in any phase relationship is likely to cause oscillations or undesired hysteresis. Of critical importance is the use of low impedance supply planes, particularly the output supply plane ( $V_{CC}$ ) and the ground plane. Separate supply planes are recommended as part of a multilayer board. Providing the lowest inductance return path for switching currents ensures the best possible performance in the target application.

It is also important to adequately bypass the input and output supplies. Place a 0.1  $\mu\text{F}$  bypass capacitor as close as possible to each supply pin. The capacitors should be connected to the ground plane with redundant vias placed to provide a physically short return path for output currents flowing back from ground to the  $V_{CC}$  pin. Use high frequency bypass capacitors for minimum inductance and effective series resistance (ESR). Parasitic layout inductance should also be strictly controlled to maximize the effectiveness of the bypass at high frequencies.

### TTL-/CMOS-COMPATIBLE OUTPUT STAGE

To achieve the specified propagation delay performance, keep the capacitive load at or below the specified maximum value. The outputs of the AD8469 are designed to directly drive one Schottky TTL or three low power Schottky TTL loads (or equivalent). For large fan outputs, buses, or transmission lines, use an appropriate buffer to maintain the excellent speed and stability of the comparator.

With the rated 15 pF load capacitance applied, more than half of the total device propagation delay is output stage slew time. For this reason, the total propagation delay decreases as  $V_{CC}$  decreases, and instability in the power supply may appear as excess delay dispersion.

Delay is measured to the 50% point of the supply that is in use; therefore, the fastest times are observed with the  $V_{CC}$  supply at 2.5 V, and larger delay values are observed when driving loads that switch at other levels.

Overdrive and input slew rate dispersions are not significantly affected by output loading and  $V_{CC}$  variations.

A simplified schematic diagram of the TTL-/CMOS-compatible output stage is shown in Figure 11. Because of its inherent symmetry and generally good behavior, this output stage is readily adaptable for driving various filters and other unusual loads.

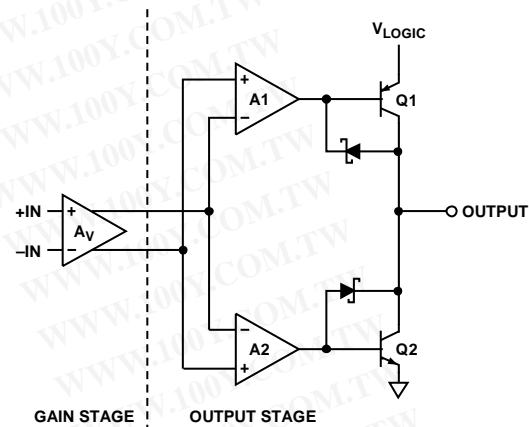

Figure 11. Simplified Schematic Diagram of TTL-/CMOS-Compatible Output Stage

### OPTIMIZING PERFORMANCE

As with any high speed comparator, proper design and layout techniques are essential to obtain the specified performance. Stray capacitance, inductance, common power and ground impedances, or other layout issues can severely limit performance and often cause oscillation. Source impedance should be minimized as much as possible. High source impedance, in combination with the parasitic input capacitance of the comparator, causes an undesirable degradation in bandwidth at the input, therefore degrading the overall response. Higher impedances encourage undesired coupling.

### COMPARATOR PROPAGATION DELAY DISPERSION

The AD8469 comparator is designed to reduce propagation delay dispersion over a wide input overdrive range of 10 mV to  $V_{CC} - 1$  V. Propagation delay dispersion is the variation in propagation delay that results from a change in the degree of overdrive or slew rate—that is, how far or how fast the input signal exceeds the switching threshold (see Figure 12 and Figure 13).

The propagation delay dispersion specification becomes important in high speed, time critical applications, such as data communication, automatic test and measurement, and instrumentation. It is also important in event driven applications, such as pulse spectroscopy, nuclear instrumentation, and medical imaging. Dispersion is the variation in propagation delay as the input overdrive conditions are changed (see Figure 12).

The propagation delay dispersion of the AD8469 is typically <12 ns as the overdrive varies from 10 mV to 125 mV. This specification applies to both positive and negative signals because the device has very closely matched delays for both positive-going and negative-going inputs, and very low output skews. Note that for repeatable dispersion measurements the actual device offset is added to the overdrive.



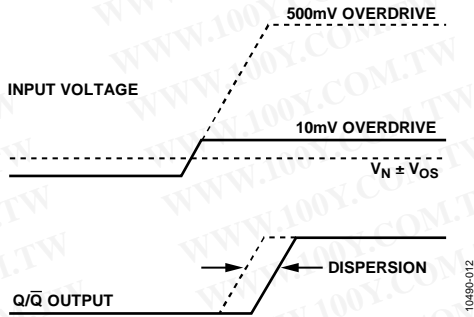

Figure 12. Propagation Delay—Overdrive Dispersion

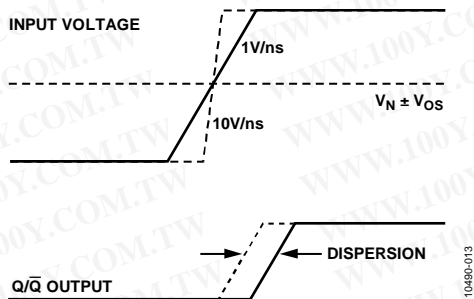

Figure 13. Propagation Delay—Slew Rate Dispersion

**COMPARATOR HYSTERESIS**

The addition of hysteresis to a comparator is often desirable in noisy environments or when the differential input amplitudes are relatively small or slow moving. The transfer function for a comparator with hysteresis is shown in Figure 14.

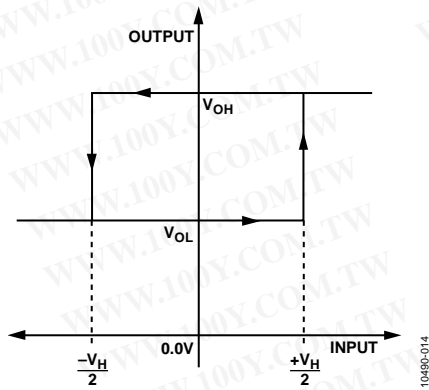

Figure 14. Comparator Hysteresis Transfer Function

As the input voltage approaches the threshold (0.0 V in Figure 14) from below the threshold region in a positive direction, the comparator switches from low to high when the input crosses  $+V_H/2$ . The new switching threshold becomes  $-V_H/2$ . The comparator remains in the high state until the threshold,  $-V_H/2$ , is crossed from below the threshold region in a negative direction. In this way, noise or feedback output signals centered on the 0.0 V input cannot cause the comparator to switch states unless they exceed the region bounded by  $\pm V_H/2$ .

The customary technique for introducing hysteresis into a comparator uses positive feedback from the output back to the input. One limitation of this approach is that the amount of hysteresis varies with the output logic level, resulting in hysteresis that is not symmetric about the threshold. The external feedback network can also introduce significant parasitics that reduce high speed performance and can even induce oscillation in some cases.

The AD8469 comparator offers a programmable hysteresis feature that significantly improves accuracy and stability. By connecting an external pull-down resistor or current source from the HYS pin to ground, the user can vary the amount of hysteresis in a predictable, stable manner. Leaving the HYS pin disconnected or driving it high removes the hysteresis. The maximum hysteresis that can be applied using the HYS pin is approximately 160 mV. Figure 15 illustrates the amount of hysteresis applied as a function of the external resistor value.

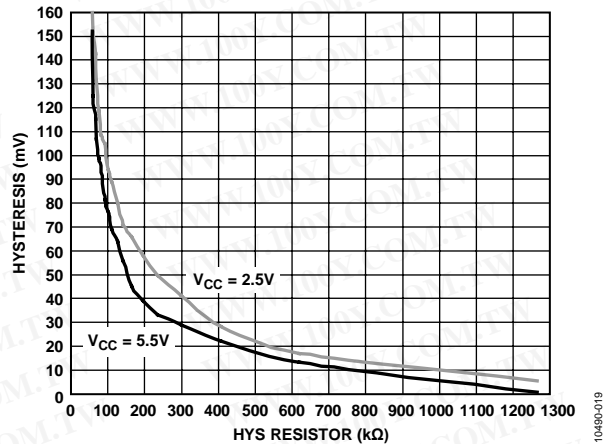

Figure 15. Hysteresis vs. HYS Resistor

The HYS pin appears as a 1.25 V bias voltage seen through a series resistance of  $7\text{ k}\Omega \pm 20\%$  throughout the hysteresis control range. The advantages of applying hysteresis in this manner are improved accuracy, improved stability, reduced component count, and maximum versatility. An external bypass capacitor is not recommended on the HYS pin because it impairs the latch function and often degrades the jitter performance of the device.

When the HYS pin is driven low, hysteresis may become large, but in this device, the effect is not reliable or intended as a latch function.

**CROSSOVER BIAS POINT**

Rail-to-rail inputs in both op amps and comparators have a dual front-end design. Certain devices are active near the  $V_{CC}$  rail, and others are active near the  $V_{EE}$  rail. At some predetermined point in the common-mode range, a crossover occurs. At the crossover point (normally  $V_{CC}/2$ ), the direction of the bias current is reversed and there are changes in measured offset voltages and currents.

The AD8469 elaborates slightly on this scheme. The crossover points are at approximately 0.8 V and 1.6 V.

### MINIMUM INPUT SLEW RATE REQUIREMENT

With the rated load capacitance and normal good PCB design (see the Power/Ground Layout and Bypassing section), the AD8469 comparator should be stable at any input slew rate with no hysteresis. Broadband noise from the input stage is observed in place of the excessive chatter that is seen with most other high speed comparators.

With additional capacitive loading or poor bypassing, oscillation may be encountered. These oscillations are due to the high gain bandwidth of the comparator in combination with feedback through parasitics in the package and PCB. In many applications, chatter is not harmful.

TYPICAL APPLICATIONS CIRCUITS

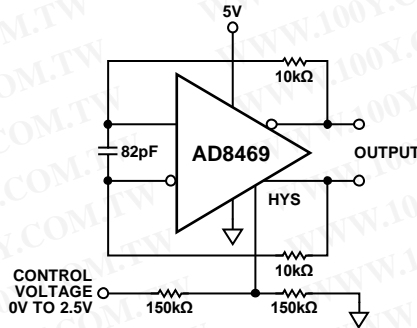

Figure 16. Voltage Controlled Oscillator

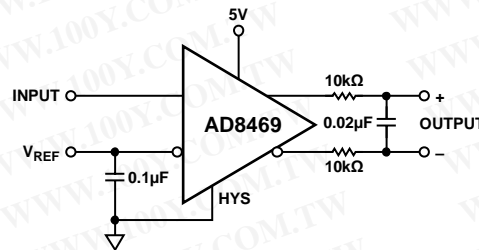

Figure 17. Duty Cycle to Differential Voltage Converter

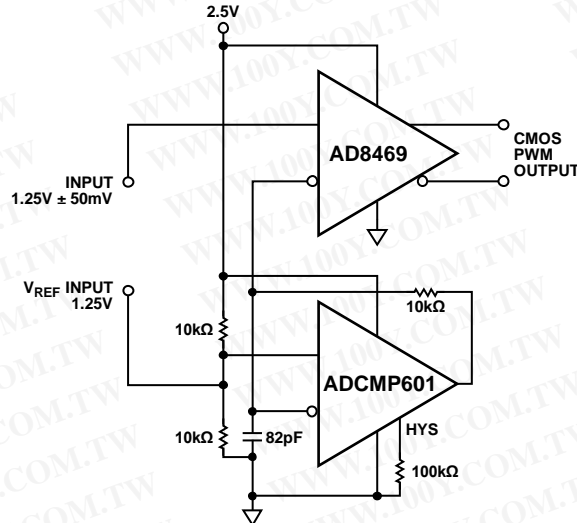
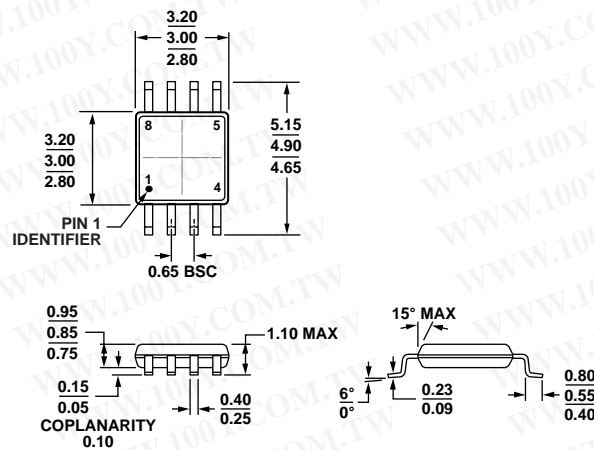

Figure 18. Oscillator and Pulse-Width Modulator

## OUTLINE DIMENSIONS

勝特力材料 886-3-5753170  
 勝特力电子(上海) 86-21-34970699  
 勝特力电子(深圳) 86-755-83298787  
[Http://www.100y.com.tw](http://www.100y.com.tw)



COMPLIANT TO JEDEC STANDARDS MO-187-AA

Figure 19. 8-Lead Mini Small Outline Package [MSOP]  
(RM-8)

Dimensions shown in millimeters

## ORDERING GUIDE

Model <sup>1, 2</sup>	Temperature Range	Package Description	Package Option	Branding
AD8469WBRMZ	-40°C to +125°C	8-Lead Mini Small Outline Package [MSOP]	RM-8	Y4F
AD8469WBRMZ-RL	-40°C to +125°C	8-Lead Mini Small Outline Package [MSOP]	RM-8	Y4F

<sup>1</sup> Z = RoHS Compliant Part.

<sup>2</sup> W = Qualified for Automotive Applications.

## AUTOMOTIVE PRODUCTS

The [AD8469W](#) models are available with controlled manufacturing to support the quality and reliability requirements of automotive applications. Note that these automotive models may have specifications that differ from the commercial models; therefore, designers should review the Specifications section of this data sheet carefully. Only the automotive grade products shown are available for use in automotive applications. Contact your local Analog Devices account representative for specific product ordering information and to obtain the specific Automotive Reliability reports for these models.