

FEATURES
Low offset voltage
B grade: 0.4 mV maximum
A grade: 1 mV maximum
Low offset voltage drift
B grade: 4 $\mu\text{V}/^\circ\text{C}$ maximum
A grade: 8 $\mu\text{V}/^\circ\text{C}$ maximum
Low input bias current: 5 pA typical at $V_{\text{SY}} = \pm 15\text{ V}$
Dual-supply operation: $\pm 4.5\text{ V}$ to $\pm 15\text{ V}$
Low noise
7.3 nV/ $\sqrt{\text{Hz}}$ typical at $f = 1\text{ kHz}$
0.45 $\mu\text{V p-p}$ at 0.1 Hz to 10 Hz
Low distortion: 0.00006%
No phase reversal
Rail-to-rail output
Unity gain stable
APPLICATIONS
Instrumentation
Medical instruments
Multipole filters
Precision current measurement
Photodiode amplifiers
Sensors
Audio
GENERAL DESCRIPTION

The **ADA4610-2** is a dual channel, precision JFET amplifier that features low input voltage and current noise, offset voltage, input bias current, and rail-to-rail output.

The combination of low offset, noise, and very low input bias current makes these amplifiers especially suitable for high impedance sensor amplification and precise current measurements using shunts. With excellent dc precision, low noise, and fast settling time, the **ADA4610-2** provides superior accuracy in medical instruments, electronic measurement, and automated test equipment. Unlike many competitive amplifiers, the **ADA4610-2** maintains fast settling performance with substantial capacitive loads. Unlike many older JFET amplifiers, the **ADA4610-2** does not suffer from output phase reversal when input voltages exceed the maximum common-mode voltage range.

Rev. B

Information furnished by Analog Devices is believed to be accurate and reliable. However, no responsibility is assumed by Analog Devices for its use, nor for any infringements of patents or other rights of third parties that may result from its use. Specifications subject to change without notice. No license is granted by implication or otherwise under any patent or patent rights of Analog Devices. Trademarks and registered trademarks are the property of their respective owners.

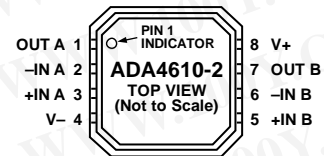
PIN CONFIGURATIONS

NOTES

1. THE EXPOSED PAD MUST BE CONNECTED TO V_{-} .

Figure 1. 8-Lead LFCSP (CP Suffix)

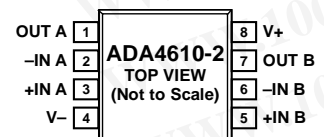

Figure 2. 8-Lead SOIC_N (R Suffix) and 8-Lead MSOP (RM Suffix)

勝特力材料 886-3-5753170
 勝特力电子(上海) 86-21-34970699
 勝特力电子(深圳) 86-755-83298787
[Http://www.100y.com.tw](http://www.100y.com.tw)

The fast slew rate and great stability with capacitive loads make the **ADA4610-2a** perfect fit for high performance filters. Low input bias currents, low offset, and low noise result in a wide dynamic range for photodiode amplifier circuits. Low noise and distortion, high output current, and excellent speed make the **ADA4610-2** a great choice for audio applications.

The **ADA4610-2** is specified over the -40°C to $+125^\circ\text{C}$ extended industrial temperature range.

The **ADA4610-2** is available in the 8-lead narrow SOIC, 8-lead MSOP, and 8-lead LFCSP packages.

IMPORTANT LINKS FOR THE ADA4610-2*

Last content update 3/19/2013 5:02 PM.

Looking for similar performance at lower price where higher offset and drift are acceptable? Consider the [ADA4001-2](#).

PARAMETRIC SELECTION TABLES:

[High Supply Voltage Amplifiers \(>=+12V\)](#)

[Low Voltage Noise Amplifiers \(\$\leq 10\$ nV/ \$\sqrt{\text{Hz}}\$ \)](#)

[Low Input Bias Current Amplifiers \(<100 pA\)](#)

勝特力材料 886-3-5753170
勝特力电子(上海) 86-21-34970699
勝特力电子(深圳) 86-755-83298787
[Http://www.100y.com.tw](http://www.100y.com.tw)

HARDWARE & SOFTWARE



[PRAOPAMP Evaluation Boards](#)



[ADA4610 SPICE Macro Model, Version 1, 2/2012](#)



[CAD Symbols & Footprints | NI Multisim](#)

EVALUATION BOARD DOCUMENTATION

See [AN-692](#) for Universal Precision Op Amp Evaluation Board information.

See [AN-734](#) for Universal Single Op Amp SC70 Package.

See [AN-732](#) for Universal Single Op Amp SOIC Package.

See [AN-735](#) for Universal Single Op Amp SOT-23 Package.

See [AN-733](#) for Universal Single Op Amp MSOP Package.

See [AN-763](#) for Universal Dual Op Amp SOIC, TSSOP and MSOP Packages.

See [AN-797](#) for Universal Quad Op Amp SOIC and TSSOP Packages.

RELATED DOCUMENTATION

[AN-202](#): An IC Amplifier User's Guide to Decoupling, Grounding, and Making Things Go Right for a Change

[Sensor Signal Conditioning Handbook - Amplifiers for Signal Conditioning](#)

[Op Amp Applications Handbook](#)

[MT-052](#): Op Amp Noise Figure: Don't Be Mislead Tutorial

[MT-048](#): Op Amp Noise Relationships: 1/f Noise, RMS Noise, and Equivalent Noise Bandwidth Tutorial

[MT-047](#): Op Amp Noise Tutorial

[Webcast: Noise Optimization in Sensor Signal Conditioning Circuits \(Part I\) \(Part II\) \(Part III\)](#) This is a three-part series that explores the topic of signal noise in detail.

[Technical Article: Low Noise Signal Conditioning for Sensor-Based Circuits](#)

[Low Noise Amplifiers Overview](#)

[Settling Time FAQ](#)

[Glossary of EE Terms](#)



Collaborate online with the ADI support team and other designers about select ADI products.



Follow us on Twitter: www.twitter.com/ADI_News

DESIGN SUPPORT

Submit your support request here:

[Linear and Data Converters](#)

[Embedded Processing and DSP](#)

Telephone our Customer Interaction Centers toll free:

Americas: 1-800-262-5643

Europe: 00800-266-822-82

China: 4006-100-006

India: 1800-419-0108

Russia: 8-800-555-45-90

[Quality and Reliability](#)
[Lead\(Pb\)-Free Data](#)

PURCHASING & CONTACT INFORMATION

[View Price & Packaging](#)

[Request Evaluation Board](#)

[Request Samples](#)

[Find Local Distributors](#)

[Check Inventory & Purchase](#)

*This page was dynamically generated by Analog Devices, Inc. and inserted into this data sheet.

Note: Dynamic changes to the content on this page (labeled 'important links') does not constitute a change to the revision number of the product data sheet.

This content may be frequently modified.

TABLE OF CONTENTS

Features	1	ESD Caution.....	6
Applications.....	1	Typical Performance Characteristics	7
Pin Configurations	1	Comparative Voltage and Variable Voltage Graphs.....	13
General Description	1	Applications Information	15
Revision History	2	Comparator Operation.....	15
Specifications.....	3	Outline Dimensions	16
Electrical Characteristics	4	Ordering Guide	17
Absolute Maximum Ratings.....	6		

REVISION HISTORY

8/12—Rev. A to Rev. B

Changes to Figure 9.....	8
--------------------------	---

5/12—Rev. 0 to Rev. A

Changes to Data Sheet Title and General Description Section..	1
Changed Input Impedance, Differential to Input Capacitance, Differential in Table 1.....	3
Added Input Resistance in Table 1	3
Changed Input Impedance, Differential to Input Capacitance, Differential in Table 2.....	4
Added Input Resistance in Table 2.....	4
Added Figure 9, Figure 10, and Figure 14	8
Added Figure 15.....	9
Updated Outline Dimensions	16
Changes to Ordering Guide	17

12/11—Revision 0: Initial Version

勝特力材料 886-3-5753170
 勝特力电子(上海) 86-21-34970699
 勝特力电子(深圳) 86-755-83298787
[Http://www.100y.com.tw](http://www.100y.com.tw)

勝特力材料 886-3-5753170
 勝特力电子(上海) 86-21-34970699
 勝特力电子(深圳) 86-755-83298787
[Http://www.100y.com.tw](http://www.100y.com.tw)

SPECIFICATIONS

$V_{SY} = \pm 5\text{ V}$, $V_{CM} = 0\text{ V}$, $T_A = 25^\circ\text{C}$, unless otherwise noted.

Table 1.

Parameter	Symbol	Test Conditions/Comments	Min	Typ	Max	Unit
INPUT CHARACTERISTICS						
Offset Voltage (B Grade) ¹	V_{OS}	$-40^\circ\text{C} < T_A < +125^\circ\text{C}$		0.2	0.4	mV
Offset Voltage (A Grade) ¹	V_{OS}	$-40^\circ\text{C} < T_A < +125^\circ\text{C}$		0.4	0.8	mV
Offset Voltage Drift (B Grade) ²	$\Delta V_{OS}/\Delta T$			0.5	4	$\mu\text{V}/^\circ\text{C}$
Offset Voltage Drift (A Grade) ²	$\Delta V_{OS}/\Delta T$			1	8	$\mu\text{V}/^\circ\text{C}$
Input Bias Current	I_B	$-40^\circ\text{C} < T_A < +125^\circ\text{C}$		5	25	pA
Input Offset Current	I_{OS}	$-40^\circ\text{C} < T_A < +125^\circ\text{C}$		2	20	pA
Input Voltage Range			-2.5		+2.5	V
Common-Mode Rejection Ratio	CMRR	$V_{CM} = -2.5\text{ V to }+2.5\text{ V}$ $-40^\circ\text{C} < T_A < +125^\circ\text{C}$	94	110		dB
Large Signal Voltage Gain	A_{VO}	$R_L = 2\text{ k}\Omega$, $V_{OUT} = -3.5\text{ V to }+3.5\text{ V}$ $-40^\circ\text{C} < T_A < +125^\circ\text{C}$	98	100		dB
Input Capacitance, Differential		$V_{CM} = 0\text{ V}$		3.1		pF
Input Capacitance, Common-Mode		$V_{CM} = 0\text{ V}$		4.8		pF
Input Resistance		$V_{CM} = 0\text{ V}$		$>1 \times 10^{13}$		Ω
OUTPUT CHARACTERISTICS						
Output Voltage High	V_{OH}	$R_L = 2\text{ k}\Omega$ $-40^\circ\text{C} < T_A < +125^\circ\text{C}$	4.85	4.90		V
		$R_L = 600\ \Omega$ $-40^\circ\text{C} < T_A < +125^\circ\text{C}$	4.6	4.89		V
Output Voltage Low	V_{OL}	$R_L = 2\text{ k}\Omega$ $-40^\circ\text{C} < T_A < +125^\circ\text{C}$		-4.95	-4.9	V
		$R_L = 600\ \Omega$ $-40^\circ\text{C} < T_A < +125^\circ\text{C}$		-4.9	-4.75	V
Short-Circuit Current	I_{SC}	$-40^\circ\text{C} < T_A < +125^\circ\text{C}$		± 63		mA
POWER SUPPLY						
Power Supply Rejection Ratio	PSRR	$V_{SY} = \pm 4.5\text{ V to } \pm 18\text{ V}$ $-40^\circ\text{C} < T_A < +125^\circ\text{C}$	106	125		dB
Supply Current/Amplifier	I_S	$I_{OUT} = 0\text{ mA}$ $-40^\circ\text{C} < T_A < +125^\circ\text{C}$		1.5	1.7	mA
DYNAMIC PERFORMANCE						
Gain Bandwidth Product	GBP	$V_{IN} = 5\text{ mV p-p}$, $R_L = 2\text{ k}\Omega$, $A_V = 100$		15.4		MHz
Unity-Gain Crossover	UGC	$V_{IN} = 5\text{ mV p-p}$, $R_L = 2\text{ k}\Omega$, $A_V = -10$		9.3		MHz
Phase Margin	ϕ_M			61		Degrees
-3 dB Closed-Loop Bandwidth	-3 dB	$A_V = 1$, $V_{IN} = 5\text{ mV p-p}$		10.6		MHz
NOISE PERFORMANCE						
Voltage Noise	e_n p-p	0.1 Hz to 10 Hz		0.45		$\mu\text{V p-p}$
Voltage Noise Density	e_n	$f = 10\text{ Hz}$		14		$\text{nV}/\sqrt{\text{Hz}}$
		$f = 100\text{ Hz}$		8.2		$\text{nV}/\sqrt{\text{Hz}}$
		$f = 1\text{ kHz}$		7.3		$\text{nV}/\sqrt{\text{Hz}}$
		$f = 10\text{ kHz}$		7.3		$\text{nV}/\sqrt{\text{Hz}}$

¹ Offset voltage does not include solder heat resistance.

² Guaranteed by design and characterization.

ELECTRICAL CHARACTERISTICS

$V_{SY} = \pm 15\text{ V}$, $V_{CM} = 0\text{ V}$, $T_A = 25^\circ\text{C}$, unless otherwise noted.

Table 2.

Parameter	Symbol	Test Conditions/Comments	Min	Typ	Max	Unit
INPUT CHARACTERISTICS						
Offset Voltage (B Grade) ¹	V_{OS}	$-40^\circ\text{C} < T_A < +125^\circ\text{C}$		0.2	0.4	mV
Offset Voltage (A Grade) ¹	V_{OS}	$-40^\circ\text{C} < T_A < +125^\circ\text{C}$		0.4	0.8	mV
Offset Voltage Drift (B Grade) ²	$\Delta V_{OS}/\Delta T$	$-40^\circ\text{C} < T_A < +125^\circ\text{C}$		0.5	1.8	$\mu\text{V}/^\circ\text{C}$
Offset Voltage Drift (A Grade) ²	$\Delta V_{OS}/\Delta T$	$-40^\circ\text{C} < T_A < +125^\circ\text{C}$		1	8	$\mu\text{V}/^\circ\text{C}$
Input Bias Current	I_B	$-40^\circ\text{C} < T_A < +125^\circ\text{C}$		5	25	pA
Input Offset Current	I_{OS}	$-40^\circ\text{C} < T_A < +125^\circ\text{C}$		2	1.5	nA
Input Voltage Range		$-40^\circ\text{C} < T_A < +125^\circ\text{C}$	-12.5		20	pA
Common-Mode Rejection Ratio	CMRR	$V_{CM} = -12.5\text{ V to } +12.5\text{ V}$ $-40^\circ\text{C} < T_A < +125^\circ\text{C}$	100	115	0.25	nA
Large Signal Voltage Gain	A_{VO}	$R_L = 2\text{ k}\Omega$, $V_{OUT} = \pm 13.5\text{ V}$ $-40^\circ\text{C} < T_A < +125^\circ\text{C}$	96	107	+12.5	V
Input Capacitance, Differential		$V_{CM} = 0\text{ V}$		3.1		dB
Input Capacitance, Common-Mode		$V_{CM} = 0\text{ V}$		4.8		dB
Input Resistance		$V_{CM} = 0\text{ V}$		$> 1 \times 10^{13}$		dB
OUTPUT CHARACTERISTICS						
Output Voltage High	V_{OH}	$R_L = 2\text{ k}\Omega$ $-40^\circ\text{C} < T_A < +125^\circ\text{C}$	14.8	14.9		V
		$R_L = 600\ \Omega$ $-40^\circ\text{C} < T_A < +125^\circ\text{C}$	14.65	14.47		V
Output Voltage Low	V_{OL}	$R_L = 2\text{ k}\Omega$ $-40^\circ\text{C} < T_A < +125^\circ\text{C}$	14.25	-14.9	-14.85	V
		$R_L = 600\ \Omega$ $-40^\circ\text{C} < T_A < +125^\circ\text{C}$	13.35	-14.68	-14.75	V
Short-Circuit Current	I_{SC}	$-40^\circ\text{C} < T_A < +125^\circ\text{C}$		± 79	-14.3	V
POWER SUPPLY						
Power Supply Rejection Ratio	PSRR	$V_{SY} = \pm 4.5\text{ V to } \pm 18\text{ V}$ $-40^\circ\text{C} < T_A < +125^\circ\text{C}$	106	125		dB
Supply Current/Amplifier	I_{SY}	$I_{OUT} = 0\text{ mA}$ $-40^\circ\text{C} < T_A < +125^\circ\text{C}$	103	1.6	1.85	dB
DYNAMIC PERFORMANCE						
Slew Rate	SR	$R_L = 2\text{ k}\Omega$	$\pm 17^2$	+25/-61		V/ μs
Gain Bandwidth Product	GBP	$V_{IN} = 5\text{ mV p-p}$, $R_L = 2\text{ k}\Omega$, $A_V = 100$		16.3		MHz
Unity-Gain Crossover	UGC	$V_{IN} = 5\text{ mV p-p}$, $R_L = 2\text{ k}\Omega$, $A_V = -10$		9.3		MHz
Phase Margin	φ_M			66		Degrees
-3 dB Closed-Loop Bandwidth	-3 dB	$A_V = 1$, $V_{IN} = 5\text{ mV p-p}$		9.50		MHz
Total Harmonic Distortion (THD) + Noise	THD + N	1 kHz, $G = +1$, $R_L = 2\text{ k}\Omega$, $V_{IN} = 6\text{ V rms}$		0.00006		%

勝特力材料 886-3-5753170
 勝特力电子(上海) 86-21-34970699
 勝特力电子(深圳) 86-755-83298787
[Http://www.100y.com.tw](http://www.100y.com.tw)

Parameter	Symbol	Test Conditions/Comments	Min	Typ	Max	Unit
NOISE PERFORMANCE						
Peak-to-Peak Voltage Noise	e_n p-p	0.1 Hz to 10 Hz bandwidth		0.45		$\mu\text{V p-p}$
Voltage Noise Density	e_n	$f = 10 \text{ Hz}$		14		$\text{nV}/\sqrt{\text{Hz}}$
		$f = 100 \text{ Hz}$		8.5		$\text{nV}/\sqrt{\text{Hz}}$
		$f = 1 \text{ kHz}$		7.3		$\text{nV}/\sqrt{\text{Hz}}$
		$f = 10 \text{ kHz}$		7.3		$\text{nV}/\sqrt{\text{Hz}}$

¹ Offset voltage does not include solder heat resistance.

² Guaranteed by design and characterization.

勝特力材料 886-3-5753170
 勝特力电子(上海) 86-21-34970699
 勝特力电子(深圳) 86-755-83298787
[Http://www.100y.com.tw](http://www.100y.com.tw)

ABSOLUTE MAXIMUM RATINGS

Table 3.

Parameter	Rating
Supply Voltage	± 18 V
Input Voltage	$\pm V_S$
Output Short-Circuit Duration to GND	Observe derating curves
Storage Temperature Range	-65°C to $+150^{\circ}\text{C}$
Operating Temperature Range	-40°C to $+125^{\circ}\text{C}$
Junction Temperature Range	-65°C to $+150^{\circ}\text{C}$
Lead Temperature (Soldering, 10 sec)	300°C
Electrostatic Discharge (Human Body Model)	2500 V

Stresses above those listed under Absolute Maximum Ratings may cause permanent damage to the device. This is a stress rating only; functional operation of the device at these or any other conditions above those indicated in the operational section of this specification is not implied. Exposure to absolute maximum rating conditions for extended periods may affect device reliability.

Table 4. Thermal Resistance

Package Type	θ_{JA}^1	θ_{JC}	Unit
8-Lead MSOP (RM-8)	142	45	$^{\circ}\text{C}/\text{W}$
8-Lead SOIC_N (R-8)	120	43	$^{\circ}\text{C}/\text{W}$
8-Lead LFCSP_VD (CP-8-9)	57	12	$^{\circ}\text{C}/\text{W}$

¹ θ_{JA} is specified for worst-case conditions, that is, θ_{JA} is specified for device soldered in circuit board for surface-mount packages.

ESD CAUTION



ESD (electrostatic discharge) sensitive device.

Charged devices and circuit boards can discharge without detection. Although this product features patented or proprietary protection circuitry, damage may occur on devices subjected to high energy ESD. Therefore, proper ESD precautions should be taken to avoid performance degradation or loss of functionality.

勝特力材料 886-3-5753170
 勝特力电子(上海) 86-21-34970699
 勝特力电子(深圳) 86-755-83298787
[Http://www.100y.com.tw](http://www.100y.com.tw)

TYPICAL PERFORMANCE CHARACTERISTICS

T_A = 25°C, unless otherwise noted.

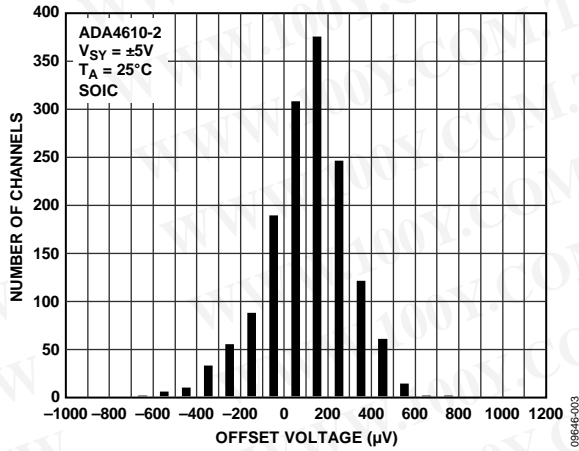

Figure 3. Input Offset Voltage Distribution

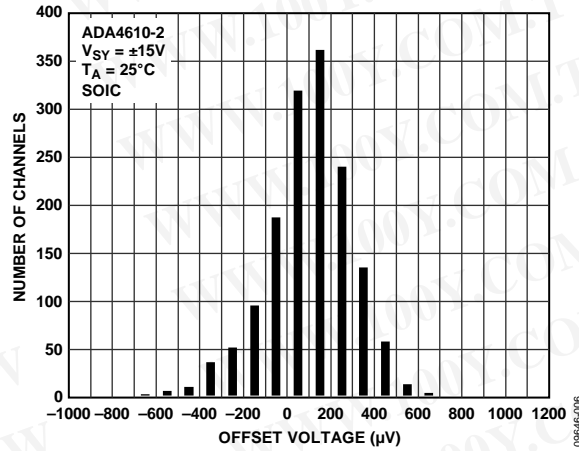

Figure 6. Input Offset Voltage Distribution

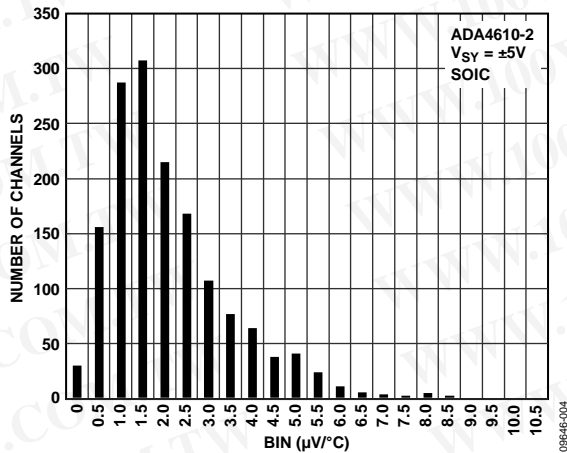

Figure 4. T_cV_{OS} Distribution

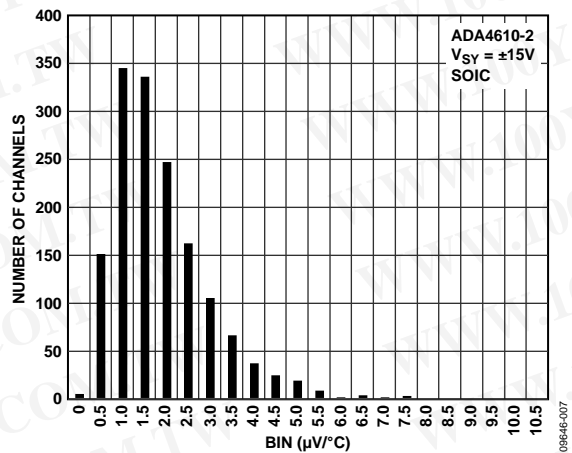

Figure 7. T_cV_{OS} Distribution

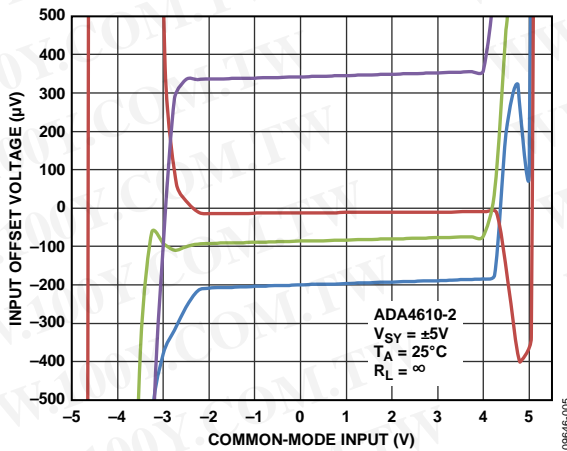

Figure 5. Input Offset Voltage vs. Common-Mode Input Voltage

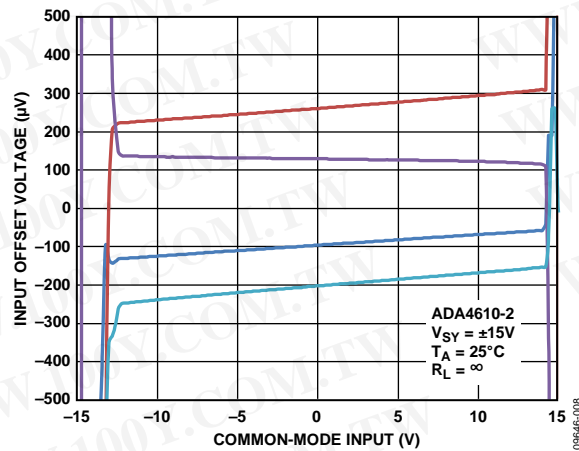

Figure 8. Input Offset Voltage vs. Common-Mode Input Voltage

勝特力材料 886-3-5753170
 勝特力电子(上海) 86-21-34970699
 勝特力电子(深圳) 86-755-83298787
[Http://www.100y.com.tw](http://www.100y.com.tw)

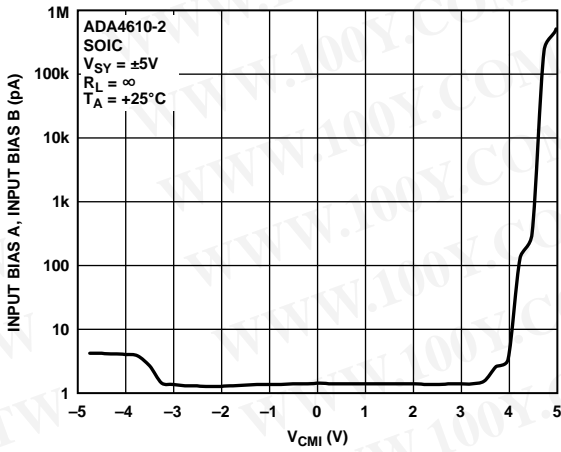

Figure 9. Input Bias Current vs. Common Mode Voltage

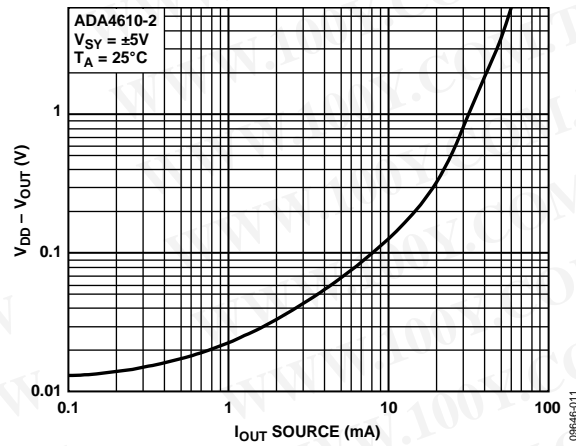

Figure 12. Dropout Voltage vs. Source Current

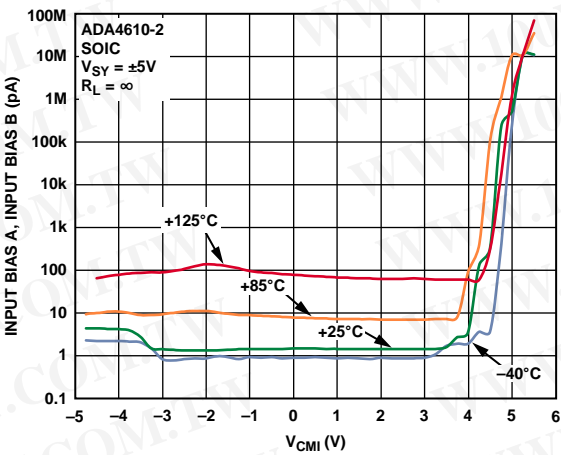

Figure 10. Input Bias Current vs. Common Mode Voltage and Temperature

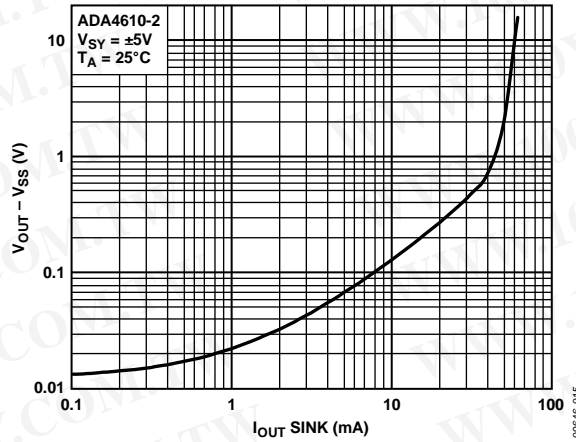

Figure 13. Dropout Voltage vs. Sink Current

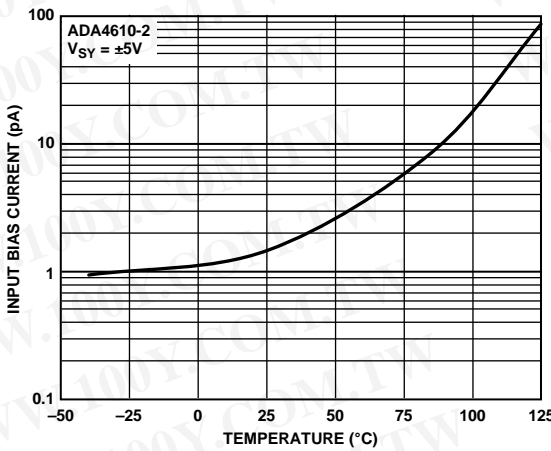

Figure 11. Input Bias Current vs. Temperature

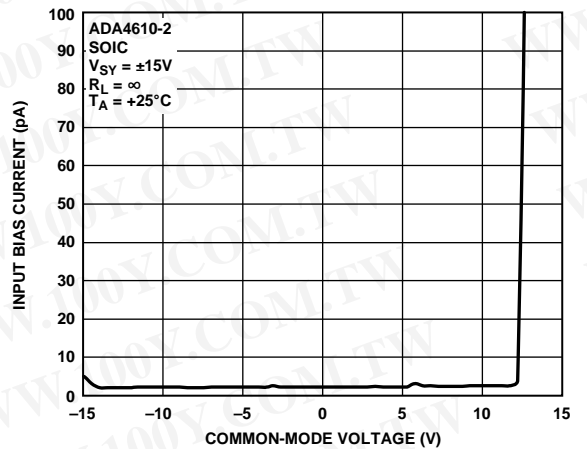

Figure 14. Input Bias Current vs. Common-Mode Voltage

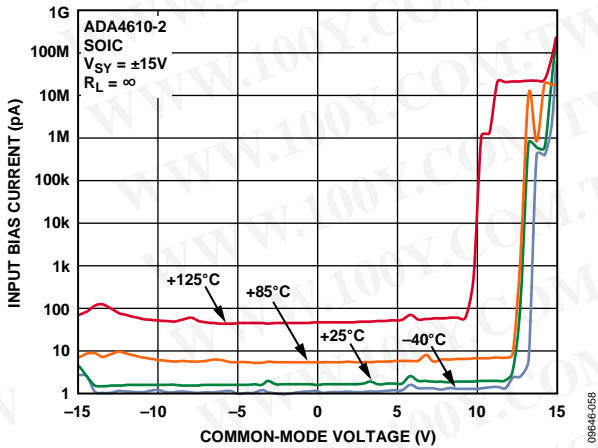

Figure 15. Input Bias Current vs. Common-Mode Voltage and Temperature

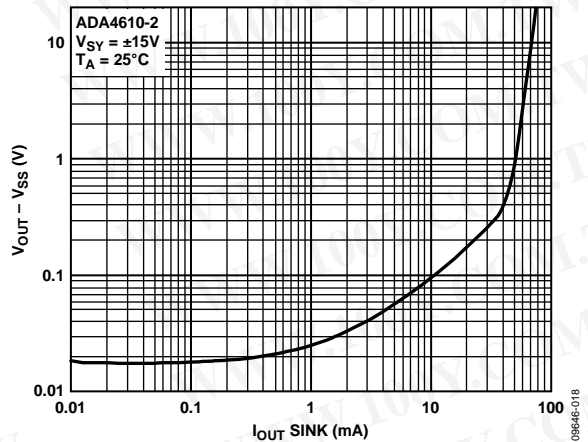

Figure 18. Dropout Voltage vs. Sink Current

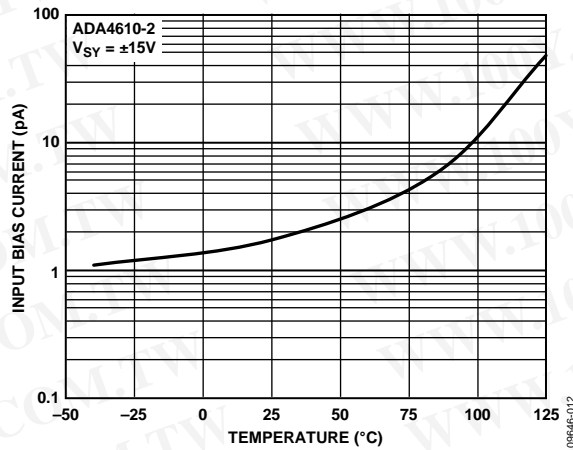

Figure 16. Input Bias Current vs. Temperature

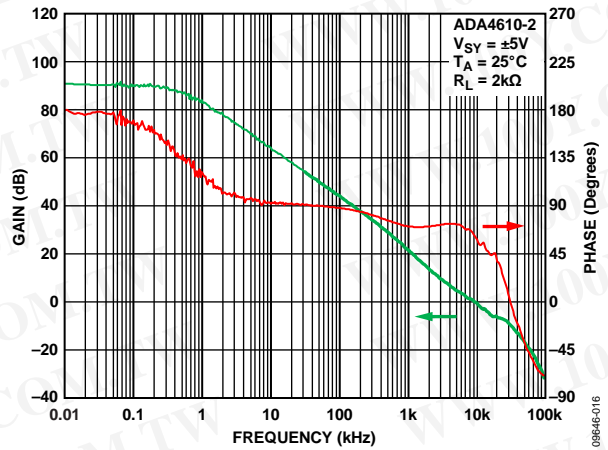

Figure 19. Open-Loop Gain and Phase vs. Frequency

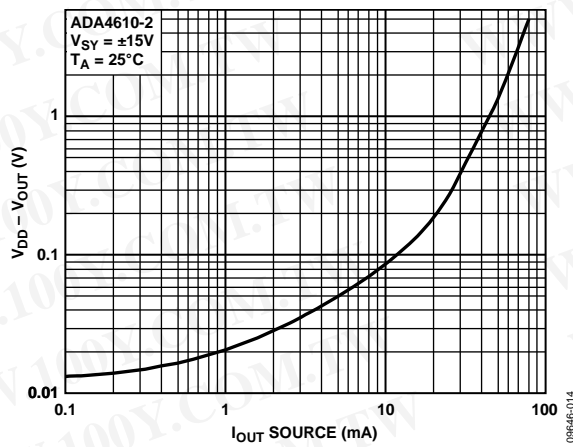

Figure 17. Dropout Voltage vs. Source Current

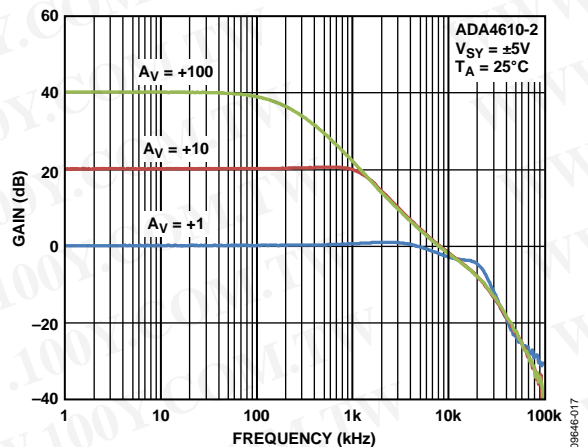

Figure 20. Closed-Loop Gain vs. Frequency

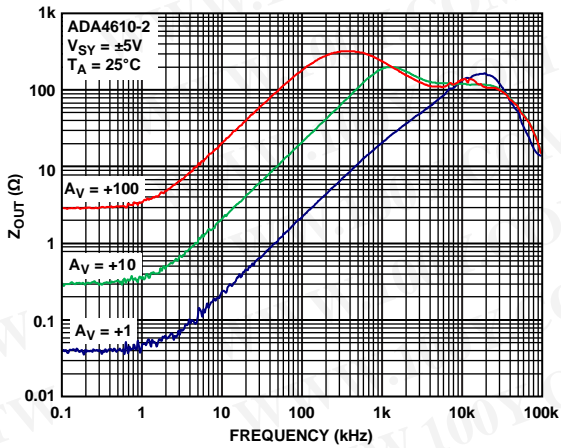

Figure 21. Closed-Loop Output Impedance vs. Frequency

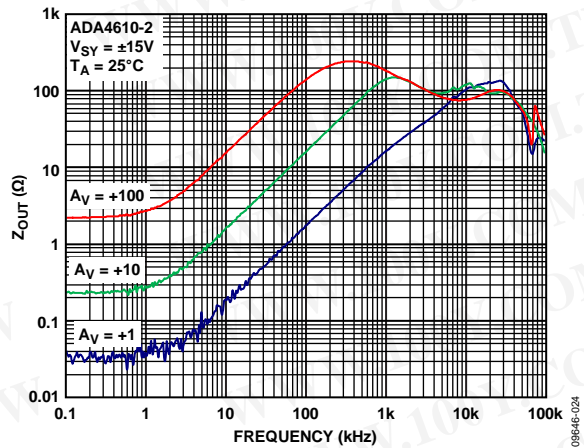

Figure 24. Closed-Loop Output Impedance vs. Frequency

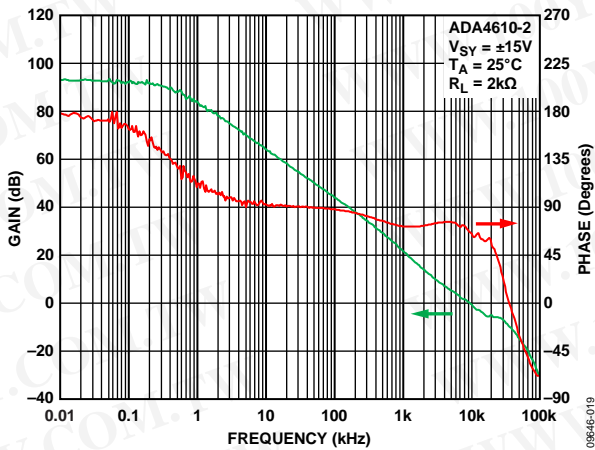

Figure 22. Open-Loop Gain and Phase vs. Frequency

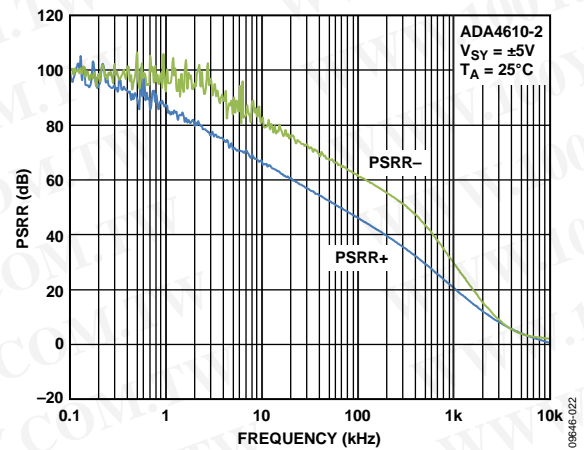

Figure 25. PSRR vs. Frequency

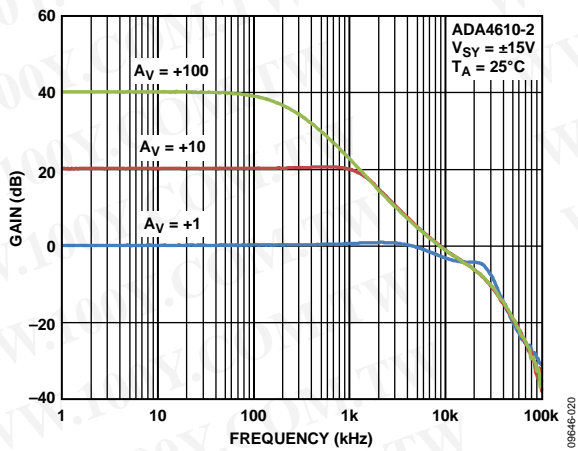

Figure 23. Closed-Loop Gain vs. Frequency

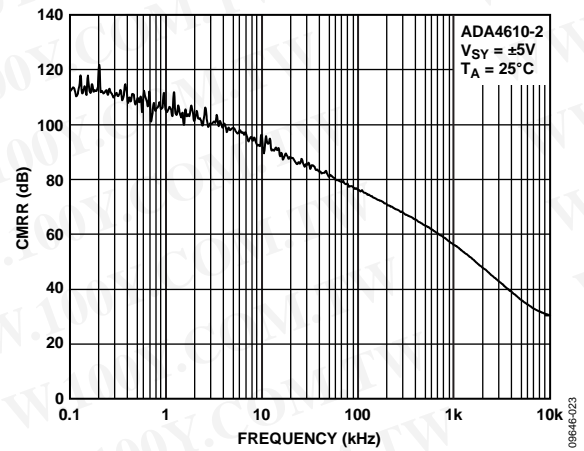

Figure 26. CMRR vs. Frequency

勝特力材料 886-3-5753170
 勝特力电子(上海) 86-21-34970699
 勝特力电子(深圳) 86-755-83298787
[Http://www.100y.com.tw](http://www.100y.com.tw)

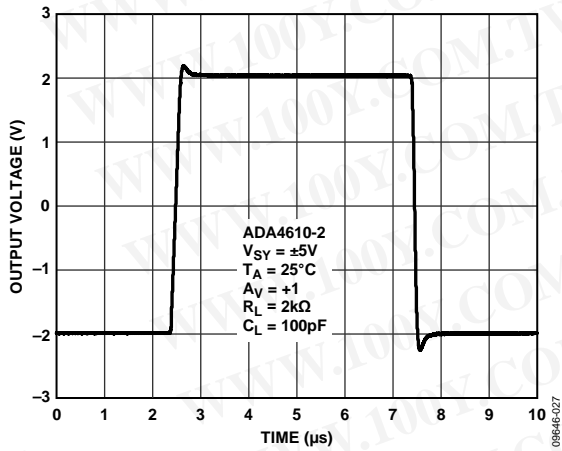

Figure 27. Large Signal Transient Response

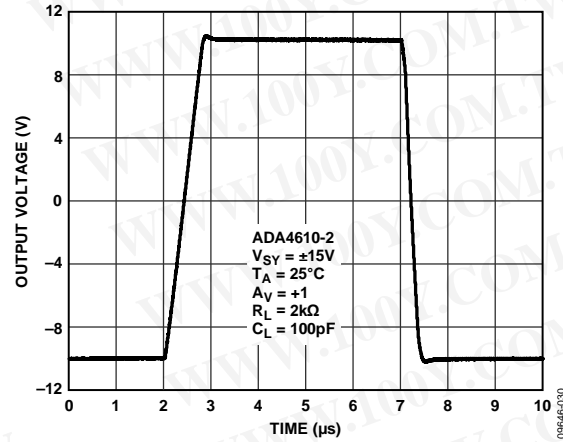

Figure 30. Large Signal Transient Response

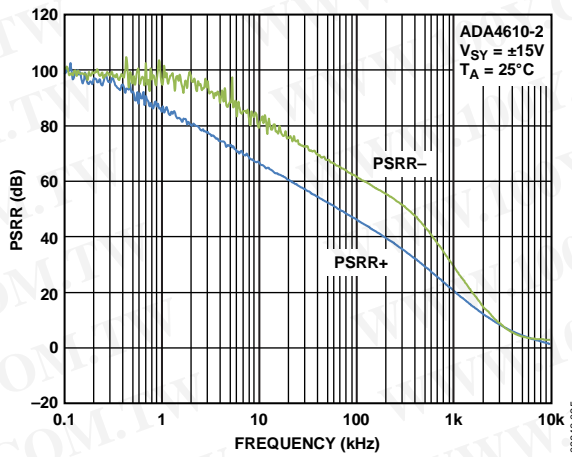

Figure 28. PSRR vs. Frequency

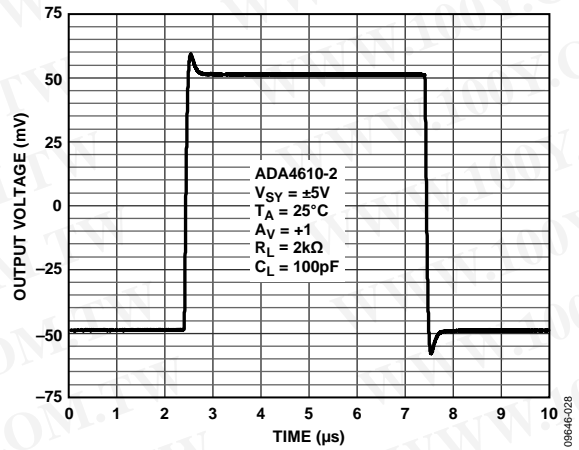

Figure 31. Small Signal Transient Response

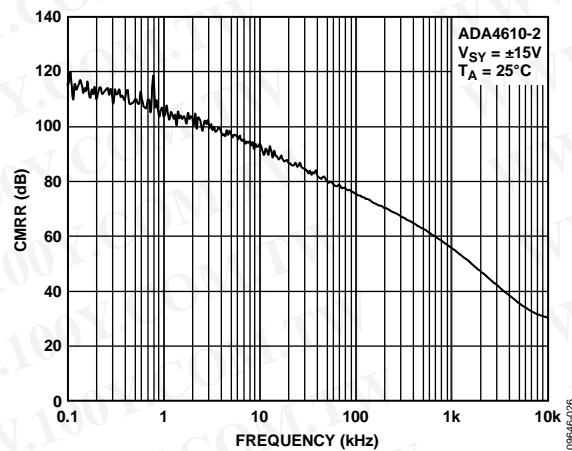

Figure 29. CMRR vs. Frequency

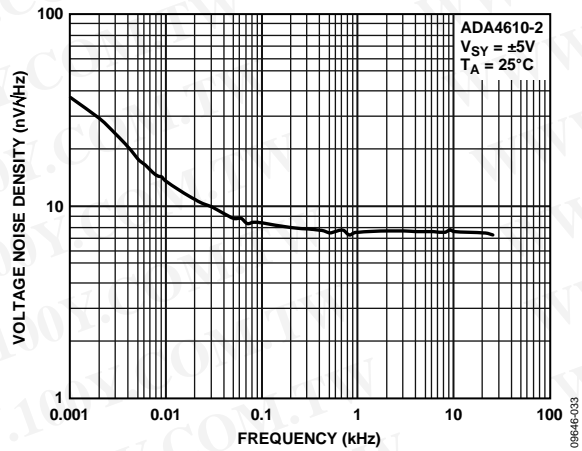

Figure 32. Voltage Noise Density

ADA4610-2

Data Sheet

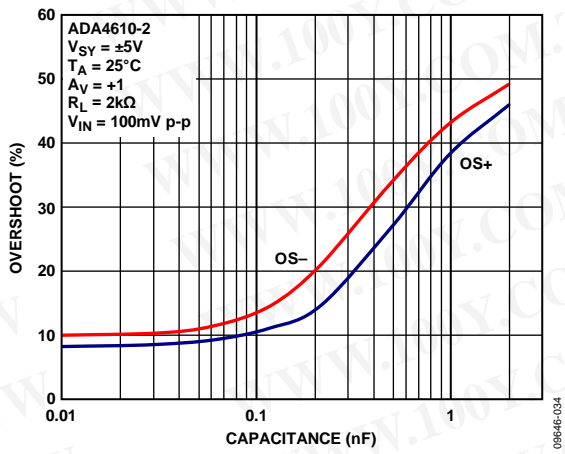

Figure 33. Overshoot vs. Load Capacitance

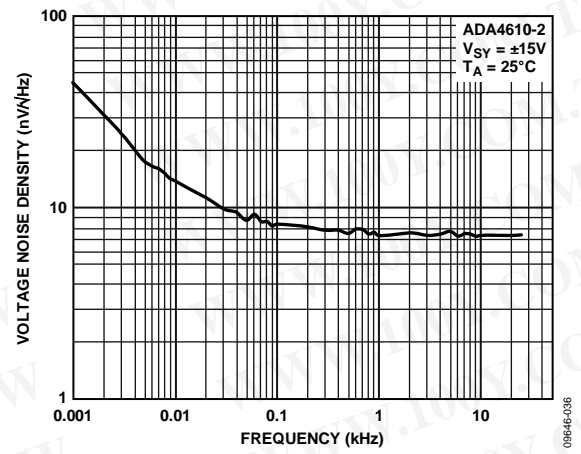

Figure 35. Voltage Noise Density

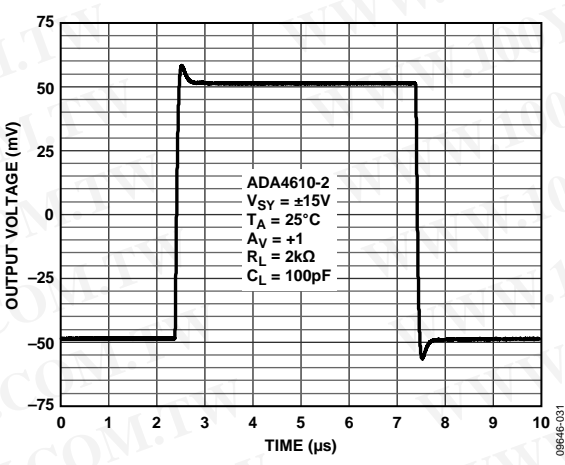

Figure 34. Small Signal Transient Response

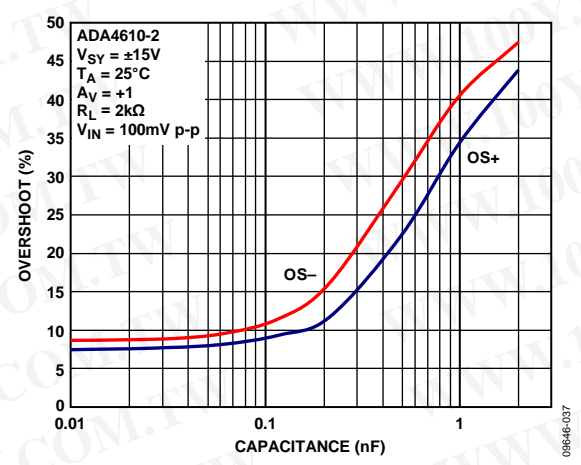

Figure 36. Overshoot vs. Load Capacitance

COMPARATIVE VOLTAGE AND VARIABLE VOLTAGE GRAPHS

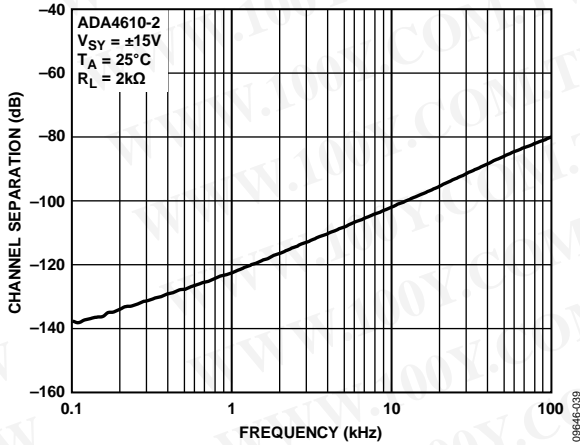

Figure 37. Channel Separation

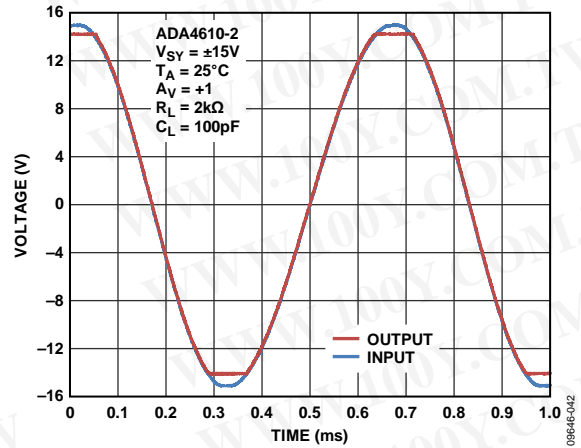

Figure 40. No Phase Reversal

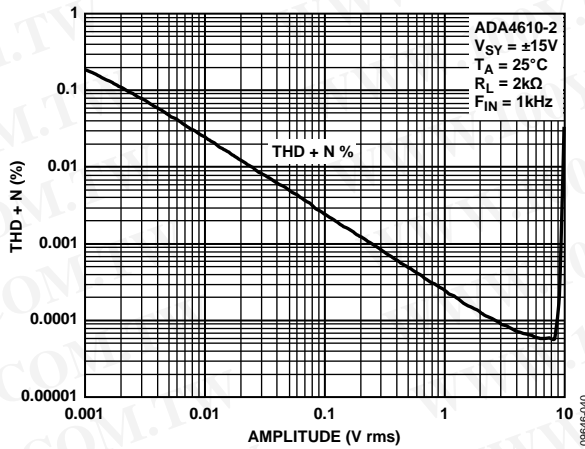

Figure 38. THD + N vs. Amplitude

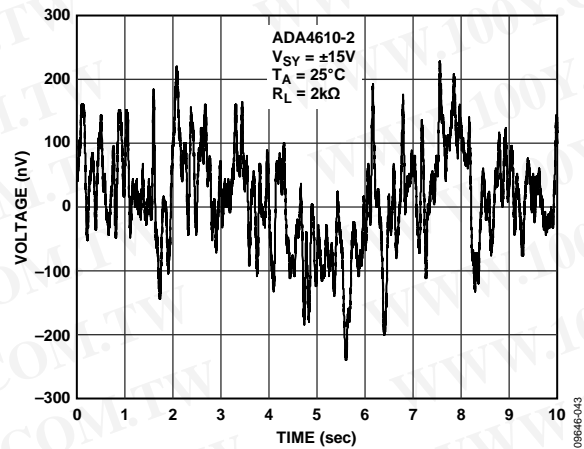

Figure 41. Voltage Noise, 0.1 Hz to 10 Hz

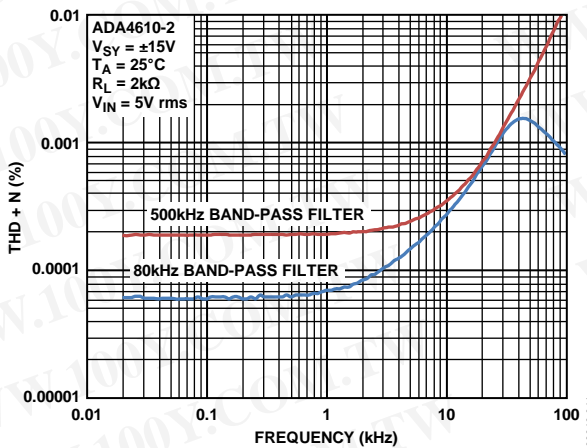

Figure 39. THD + N vs. Frequency

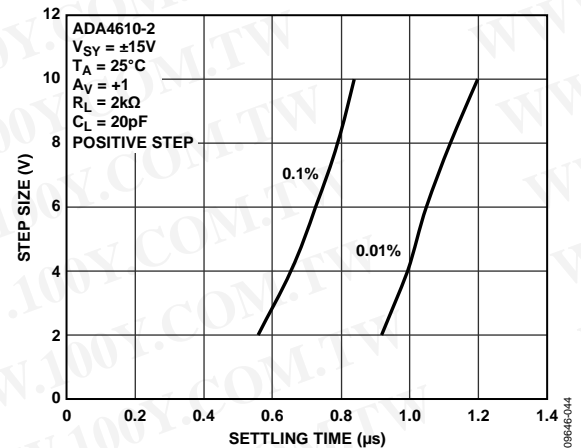

Figure 42. Positive Step Settling Time

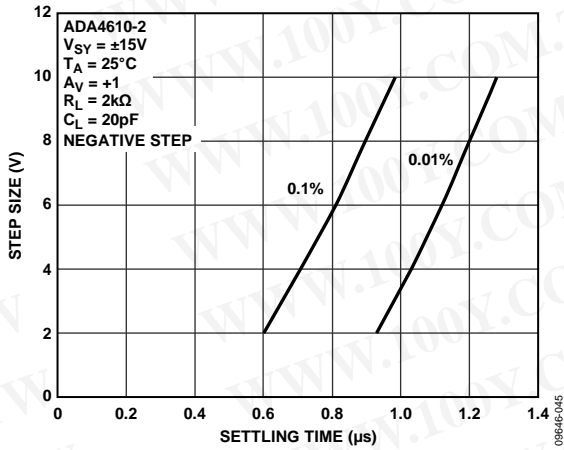

Figure 43. Negative Step Settling Time

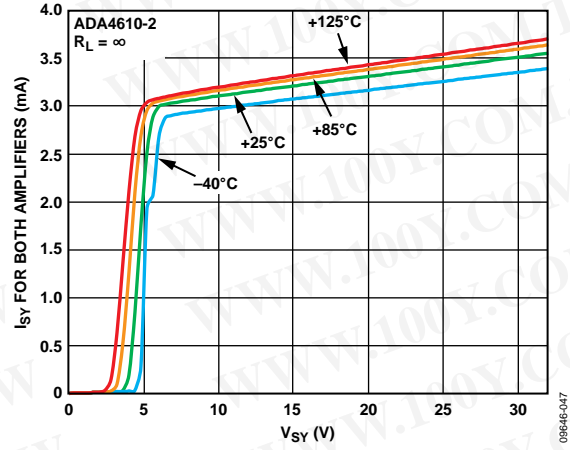

Figure 44. Supply Current vs. Supply Voltage and Temperature

勝特力材料 886-3-5753170
 勝特力电子(上海) 86-21-34970699
 勝特力电子(深圳) 86-755-83298787
[Http://www.100y.com.tw](http://www.100y.com.tw)

APPLICATIONS INFORMATION

COMPARATOR OPERATION

Although op amps are quite different from comparators, occasionally an unused section of a dual or a quad op amp may be used as a comparator; however, this is not recommended for any rail-to-rail output op amp. For rail-to-rail output op amps, the output stage is generally a ratioed current mirror with bipolar or MOSFET transistors. With the part operating open loop, the second stage increases the current drive to the ratioed mirror to close the loop. However, the second stage cannot close the loop, which results in an increase in supply current. With the op amp configured as a comparator, the supply current can be significantly higher (see Figure 45). Configuring an unused section as a voltage follower with the noninverting input connected to a voltage within the input voltage range is recommended. The ADA4610-2 has a unique output stage design that reduces the excess supply current, but does not entirely eliminate this effect when the op amp is operating open loop.

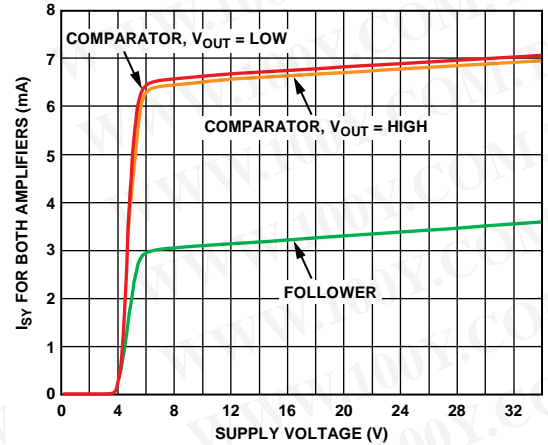

Figure 45. Supply Current vs. Supply Voltage

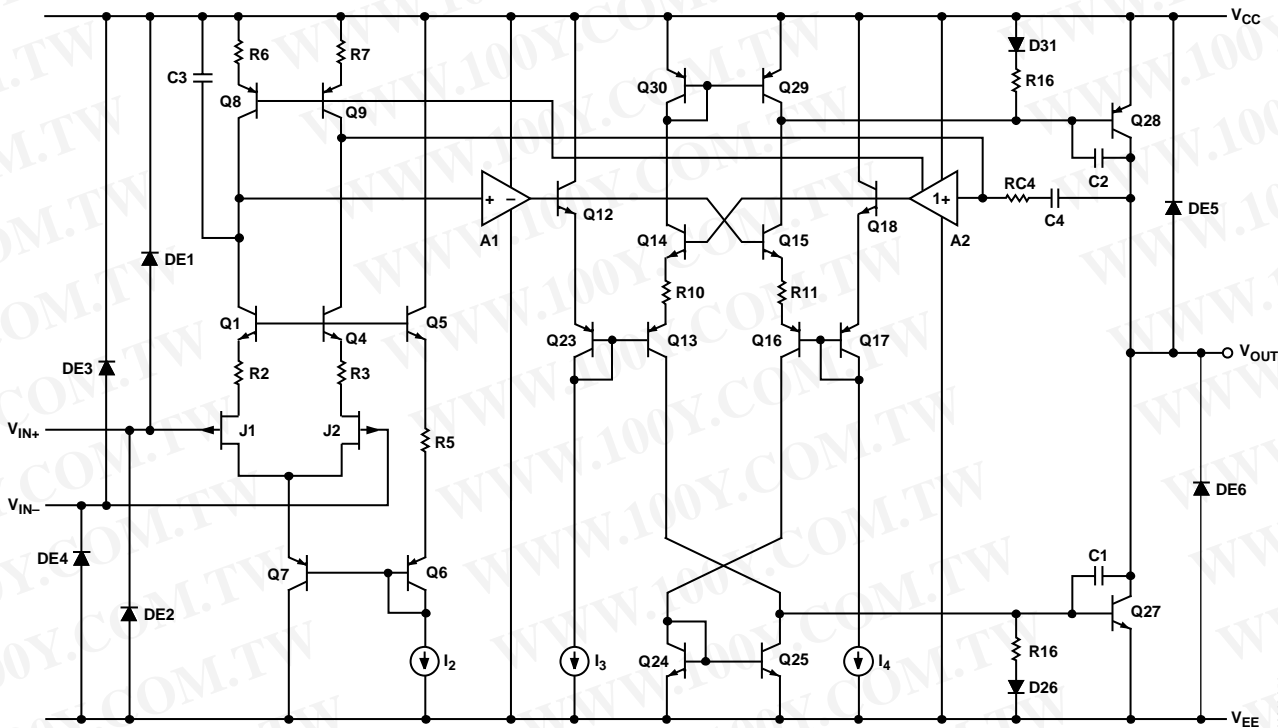
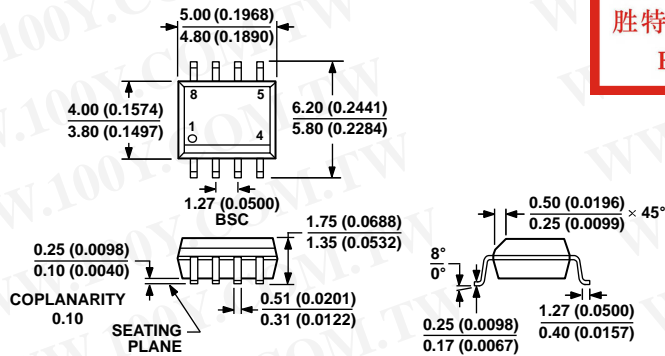

Figure 46. Simplified Schematic

勝特力材料 886-3-5753170
 勝特力电子(上海) 86-21-34970699
 勝特力电子(深圳) 86-755-83298787
[Http://www.100y.com.tw](http://www.100y.com.tw)

OUTLINE DIMENSIONS

勝特力材料 886-3-5753170
 勝特力电子(上海) 86-21-34970699
 勝特力电子(深圳) 86-755-83298787
[Http://www.100y.com.tw](http://www.100y.com.tw)



COMPLIANT TO JEDEC STANDARDS MS-012-AA
 CONTROLLING DIMENSIONS ARE IN MILLIMETERS; INCH DIMENSIONS
 (IN PARENTHESES) ARE ROUNDED-OFF MILLIMETER EQUIVALENTS FOR
 REFERENCE ONLY AND ARE NOT APPROPRIATE FOR USE IN DESIGN.

Figure 47. 8-Lead Standard Small Outline Package [SOIC_N]
 Narrow Body (R-8)
 Dimensions shown in millimeters and (inches)

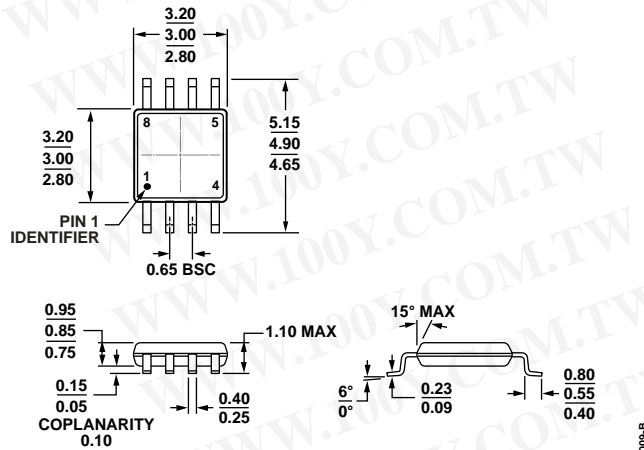

COMPLIANT TO JEDEC STANDARDS MO-187-AA
 Figure 48. 8-Lead Mini Small Outline Package [MSOP]
 (RM-8)
 Dimensions shown in millimeters

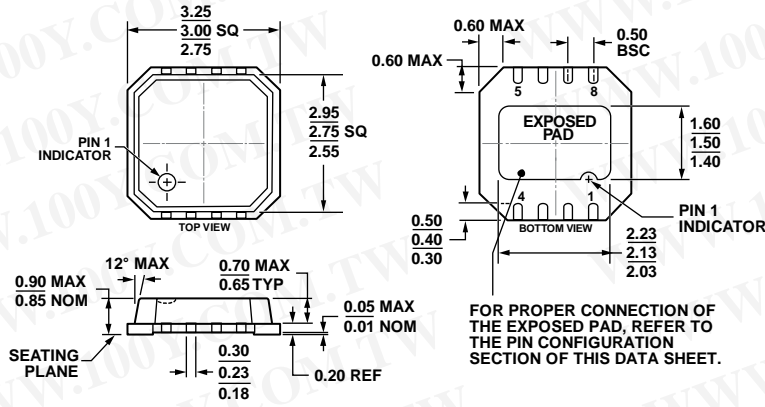

Figure 49. 8-Lead Lead Frame Chip Scale Package [LFCSF_VD]
 3 mm x 3 mm Body, Very Thin, Dual Lead
 (CP-8-9)
 Dimensions shown in millimeters

ORDERING GUIDE

Model ¹	Temperature Range	Package Description	Package Option	Branding
ADA4610-2ACPZ-R7	-40°C to +125°C	8-Lead LFCSF_VD	CP-8-9	A2U
ADA4610-2ACPZ-RL	-40°C to +125°C	8-Lead LFCSF_VD	CP-8-9	A2U
ADA4610-2ARMZ	-40°C to +125°C	8-Lead MSOP	RM-8	A2U
ADA4610-2ARMZ-R7	-40°C to +125°C	8-Lead MSOP	RM-8	A2U
ADA4610-2ARMZ-RL	-40°C to +125°C	8-Lead MSOP	RM-8	A2U
ADA4610-2ARZ	-40°C to +125°C	8-Lead SOIC_N	R-8	
ADA4610-2ARZ-R7	-40°C to +125°C	8-Lead SOIC_N	R-8	
ADA4610-2ARZ-RL	-40°C to +125°C	8-Lead SOIC_N	R-8	
ADA4610-2BRZ	-40°C to +125°C	8-Lead SOIC_N	R-8	
ADA4610-2BRZ-R7	-40°C to +125°C	8-Lead SOIC_N	R-8	
ADA4610-2BRZ-RL	-40°C to +125°C	8-Lead SOIC_N	R-8	

¹ Z = RoHS Compliant Part.

勝特力材料 886-3-5753170
 勝特力电子(上海) 86-21-34970699
 勝特力电子(深圳) 86-755-83298787
[Http://www.100y.com.tw](http://www.100y.com.tw)

NOTES

勝特力材料 886-3-5753170
勝特力电子(上海) 86-21-34970699
勝特力电子(深圳) 86-755-83298787
[Http://www.100y.com.tw](http://www.100y.com.tw)

NOTES

勝特力材料 886-3-5753170
勝特力电子(上海) 86-21-34970699
勝特力电子(深圳) 86-755-83298787
[Http://www.100y.com.tw](http://www.100y.com.tw)

NOTES

勝特力材料 886-3-5753170
勝特力电子(上海) 86-21-34970699
勝特力电子(深圳) 86-755-83298787
[Http://www.100y.com.tw](http://www.100y.com.tw)