

HA17080 Series

J-FET Input Operational Amplifiers

HITACHI

ADE-204-038 (Z)

Rev. 0

Dec. 2000

Description

Since J-FET input operational amplifiers are formed from a pair of J-FET transistors, they provide superlative characteristics, including a high input impedance and a low input bias current. Thus they can be used in a wide range of applications, from general-purpose control equipment to medical applications. In particular, they are optimal for processing signals from high-impedance sensors.

Hitachi J-FET input operational amplifiers are available in single, dual, and quad versions. Other than the HA17080, all products are internal phase compensation types and include a built-in phase compensation capacitor. The HA17080 and the HA17083 allow offset adjustment. These products are also available in "A" grade versions with superlative electrical characteristics to allow the selection of an operational amplifier appropriate for the application.

Features

- Wide operating power supply voltage range: ± 5 V to ± 18 V
- Low input bias current: 30 pA
- Low input offset current: 5 pA
- High input impedance: $10^{12} \Omega$
- High slew rate: 13 V/ μ s
- Wide common mode input voltage range with operation possible near the power-supply voltage (V_{CC}).
- High voltage gain: 106 dB
- The HA17080 and HA17083 support offset adjustment.
- Pin compatible with the Texas Instruments TL080 series.

Notes: 1. Since these products are high input impedance operational amplifiers, contamination may cause the input bias and input offset currents to increase if they are handled with bare hands.

Avoid contamination when handling these devices.

2. Since these products provide a high slew rate, oscillation may occur due to load capacitances.

($C_L < 100$ pF: voltage follower mode)



勝特力材料 886-3-5753170
勝特力电子(上海) 86-21-34970699
勝特力电子(深圳) 86-755-83298787
[Http://www.100y.com.tw](http://www.100y.com.tw)

Ordering Information

Item	Type No.			
	HA17080	HA17082	HA17083	HA17084
Number of operational amplifiers (number of channels)	Single	Dual	Dual	Quad
Offset adjustment pin	Yes	No	Yes	No
Phase compensation type	External	Internal	Internal	Internal

Pin Arrangement

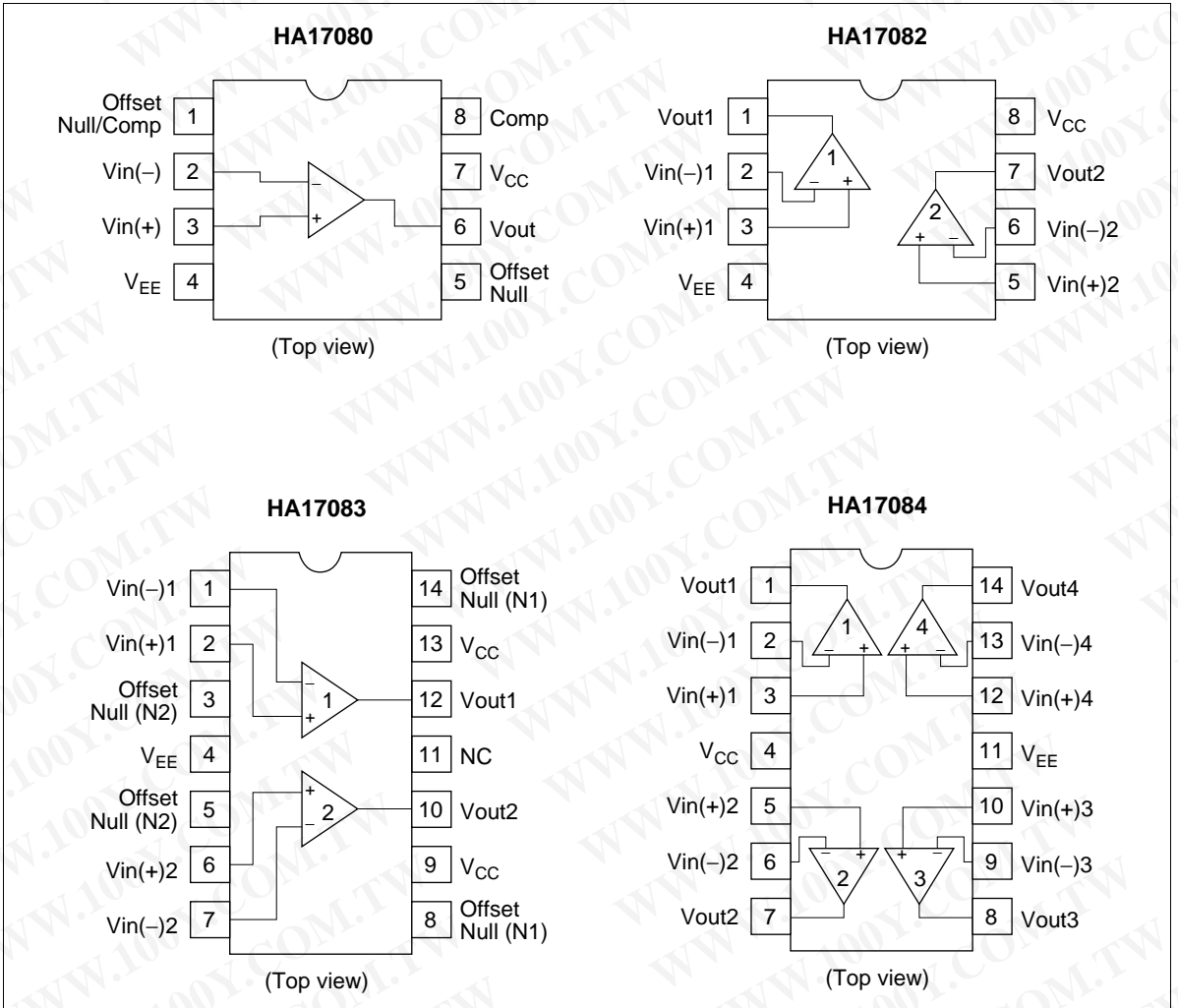

Voltage Offset Test Circuit

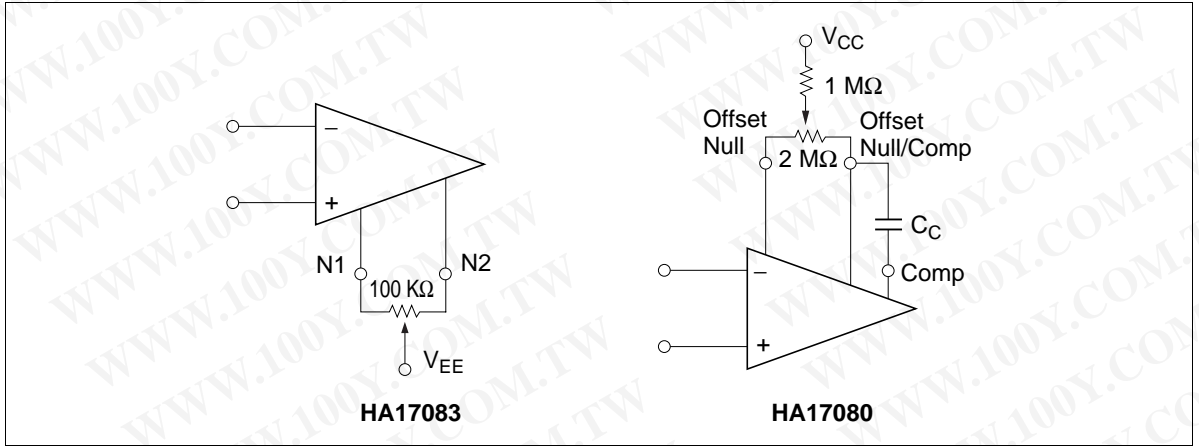

Circuit Structure

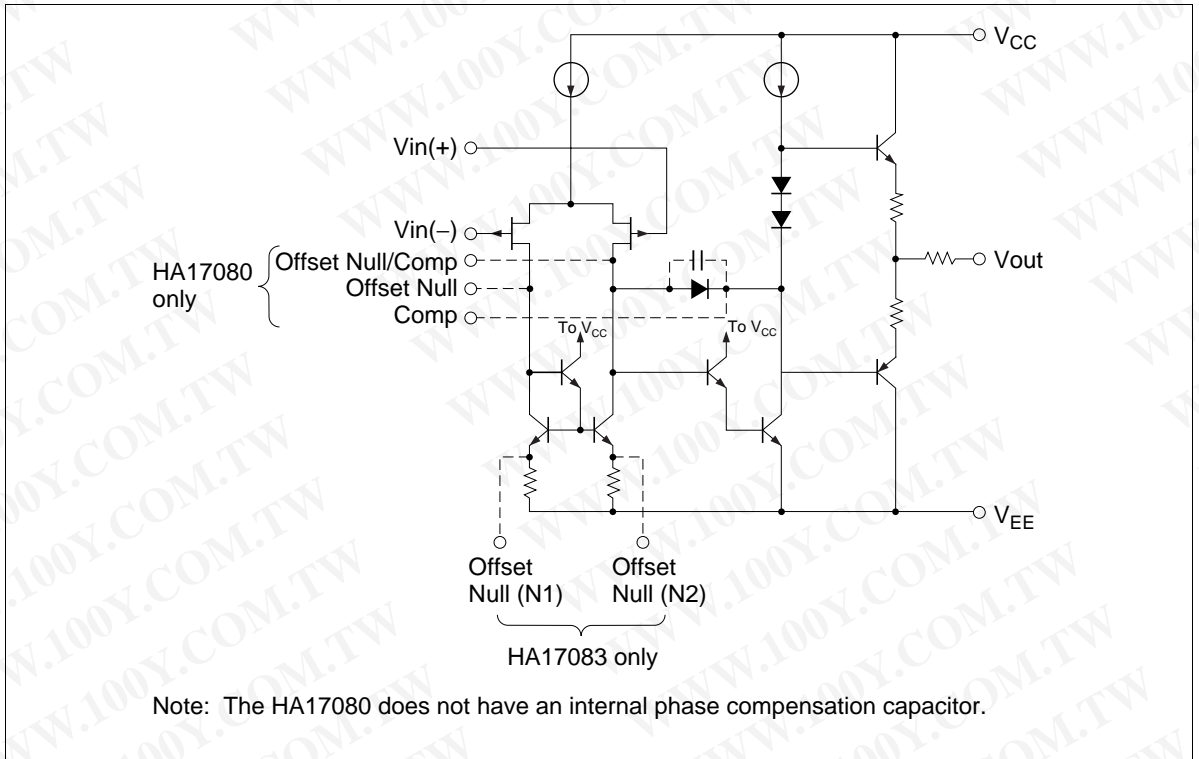

Absolute Maximum Ratings (Ta = 25°C)

Item	Symbol	Ratings (P, PS Series)	Unit	Notes
Power-supply voltage	V _{CC}	+18	V	
	V _{EE}	-18	V	
Differential input voltage	V _{in(diff)}	±30	V	
Input voltage	V _{in}	±15	V	1
Allowable power dissipation	P _T	625	mW	2
Operating temperature	T _{opr}	-20 to +75	°C	
Storage temperature	T _{stg}	-55 to +125	°C	

- Notes: 1. When the power-supply voltage is less than ±15 V, the input voltage must fall within the power-supply voltage range.
2. These are the allowable values up to Ta = 50°C for the P and PS series. Derate by 8.3 mW/°C above that temperature.

Electrical Characteristics ($V_{CC} = -V_{EE} = 15\text{ V}$, $T_a = 25^\circ\text{C}$)

Item	Symbol	HA17080 Series			HA17080A Series			Unit	Test Conditions	Notes
		Min	Typ	Max	Min	Typ	Max			
Input offset voltage	V_{IO}	—	5	15	—	3	6	mV	$R_S = 50\ \Omega$	1
Input offset current	I_{IO}	—	5	200	—	5	100	pA	$I_{IO} = I_{IB(+)} - I_{IB(-)} $	1
Input bias current	I_{IB}	—	30	400	—	30	200	pA		1, 2
Common-mode input voltage range	V_{CM}	± 10	—	—	± 11	—	—	V		1
Maximum output voltage amplitude	V_{op-p}	24	27	—	24	27	—	V	$R_L \geq 10\ \text{k}\Omega$	
		20	24	—	20	24	—	V	$R_L \geq 2\ \text{k}\Omega$	
Voltage Gain	A_{VD}	88	106	—	94	106	—	dB	$R_L \geq 2\ \text{k}\Omega$, $V_O = \pm 10\ \text{V}$	1
Common-mode rejection ratio	CMR	70	86	—	80	86	—	dB	$R_S \leq 10\ \text{k}\Omega$	1
Power supply rejection ratio	PSRR	70	86	—	80	86	—	dB	$R_S \leq 10\ \text{k}\Omega$	1
Supply current	I_{CC}	—	1.4	2.8	—	1.4	2.8	mA		3
Bandwidth	BW	—	3	—	—	3	—	MHz	$A_{VD} = 1$	
Slew rate	SR	—	13	—	—	13	—	V/ μs	$V_{in} = 10\ \text{V}$, $R_L = 2\ \text{k}\Omega$, $C_L = 100\ \text{pF}$, $A_{VD} = 1$	
Channel separation	CS	—	120	—	—	120	—	dB	$A_{VD} = 100$	
Rise time	t_r	—	0.1	—	—	0.1	—	μs	$V_{in} = 20\ \text{mV}$, $R_L = 2\ \text{k}\Omega$	
Overshoot	V_{over}	—	10	—	—	10	—	%	$C_L = 100\ \text{pF}$, $A_{VD} = 1$	
Input resistance	R_{in}	—	10^{12}	—	—	10^{12}	—	Ω		
Input noise voltage	V_n	—	35	—	—	35	—	nV/ $\sqrt{\text{Hz}}$	$R_S = 100\ \Omega$, $f = 1\ \text{kHz}$	

Notes: 1. The non-A ratings apply to the HA17080, HA17082, HA17083, and HA17084.

The A version ratings apply to the HA17080A, HA17082A, HA17083A, and HA17084A.

2. This is the J-FET gate leakage current, which is temperature dependent. The junction temperature must be held near room temperature when measuring this parameter.
3. This is the per-channel value.

Characteristic Curves

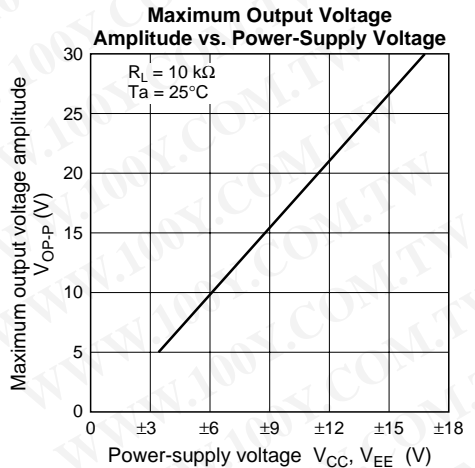
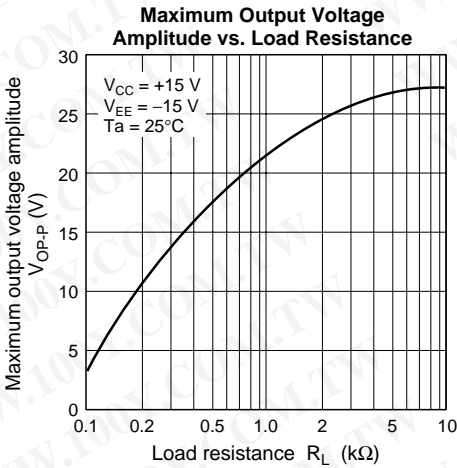
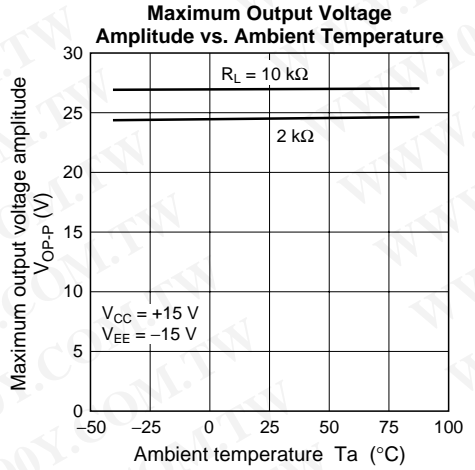
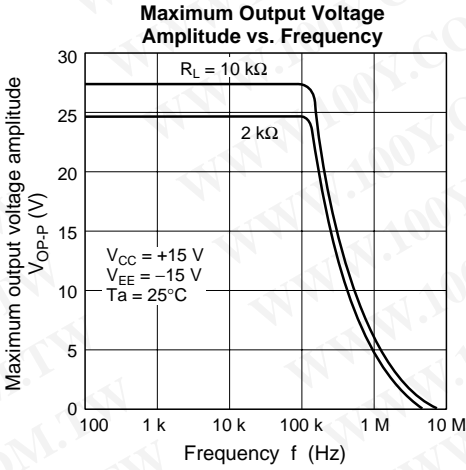
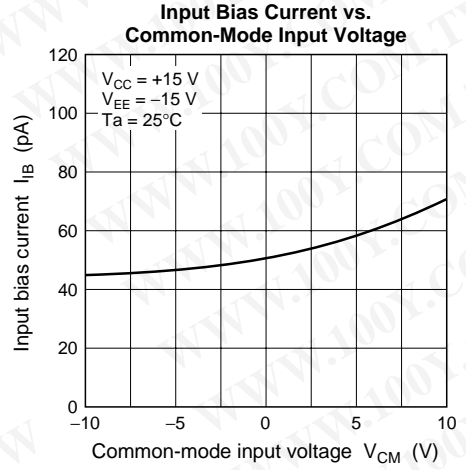
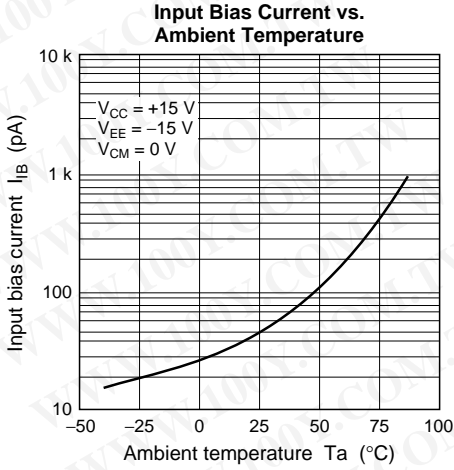

Voltage Gain vs. Frequency (1)

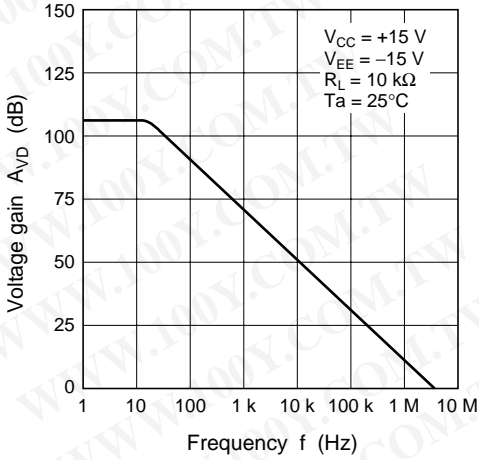

Voltage Gain vs. Frequency (2)

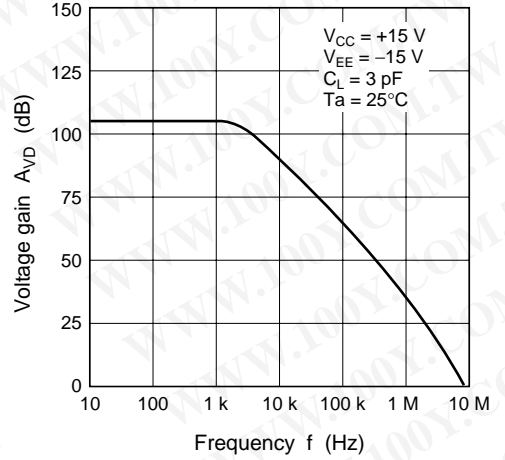

Voltage Gain vs. Ambient Temperature

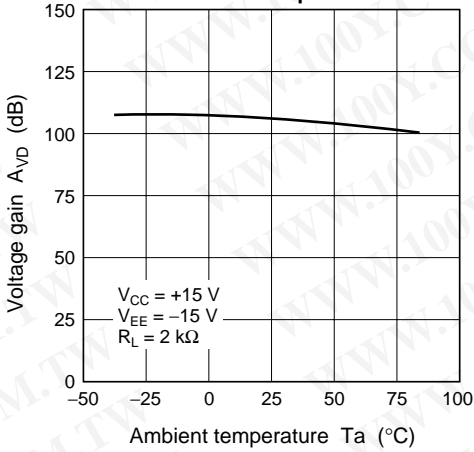

Input Noise Voltage vs. Frequency

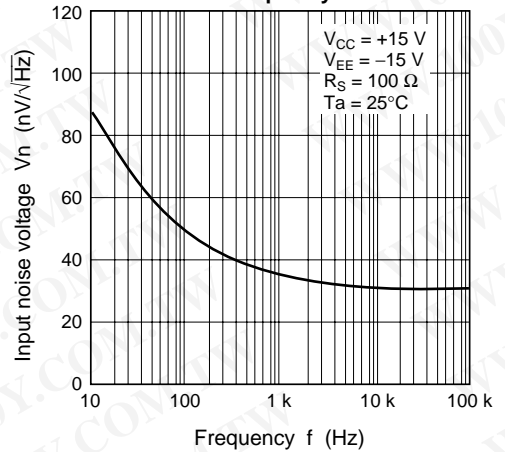

Common-Mode Rejection Ratio vs. Frequency

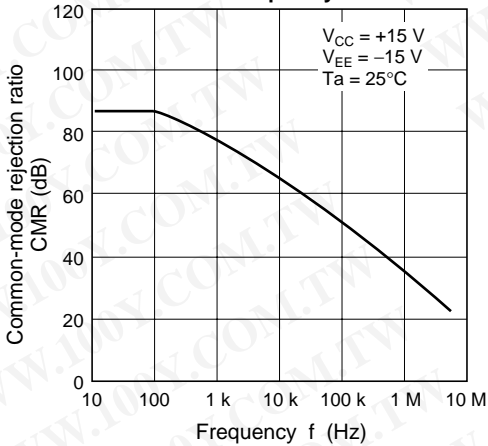

Power-Supply Rejection Ratio vs. Frequency

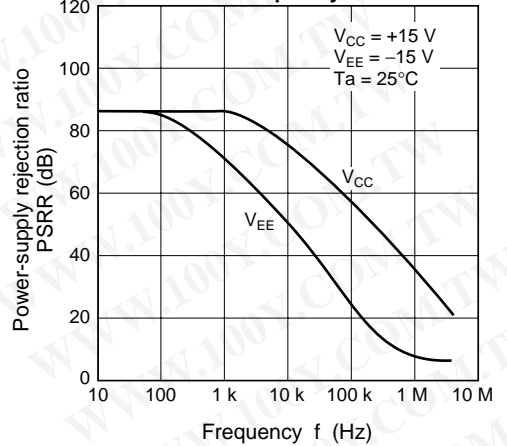

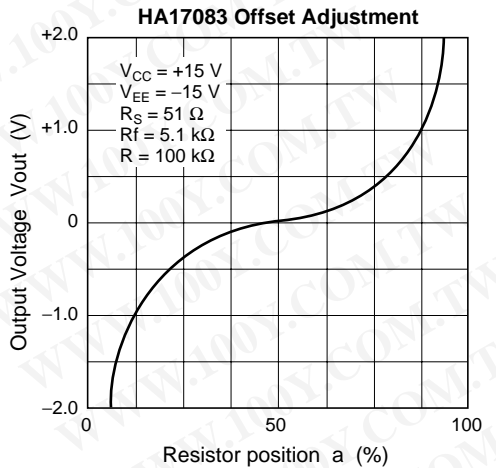
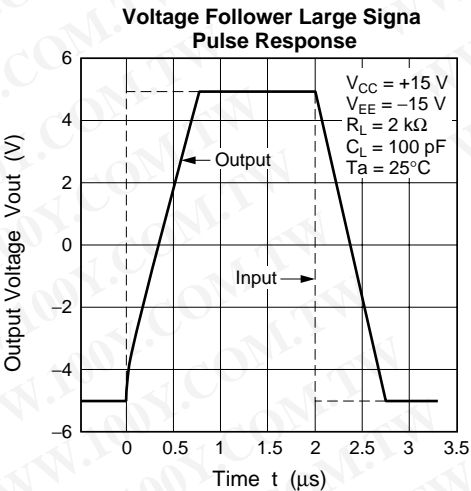
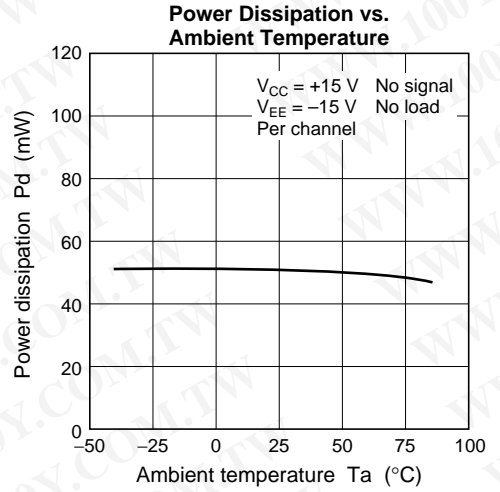
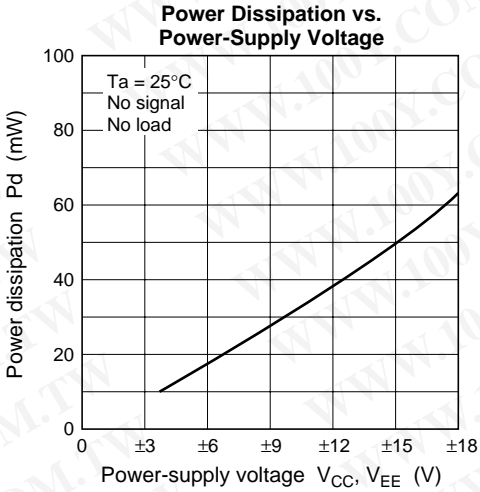
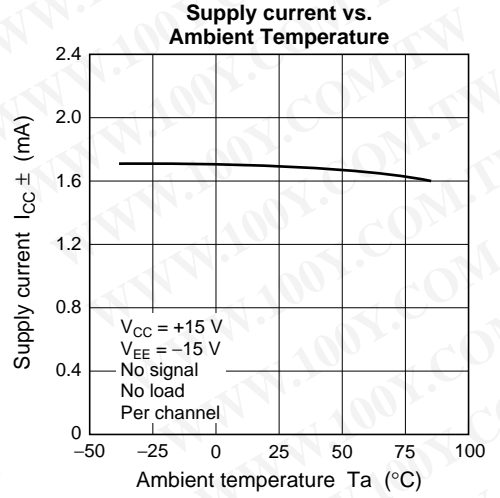
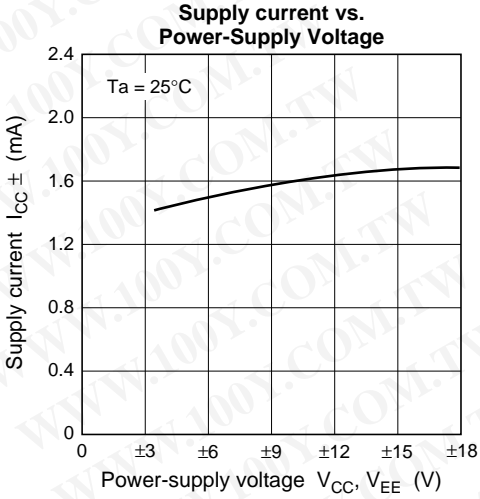

Package Dimensions

Unit: mm

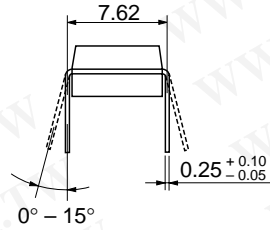
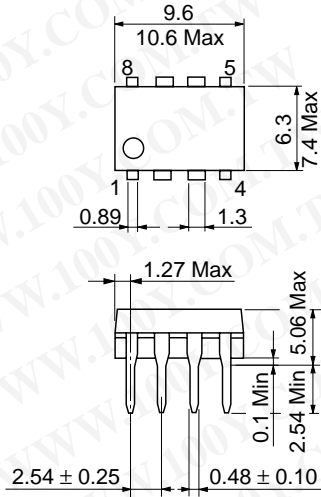

Hitachi Code	DP-8
JEDEC	Conforms
EIAJ	Conforms
Mass (reference value)	0.54 g

Unit: mm

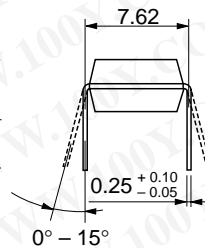
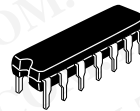
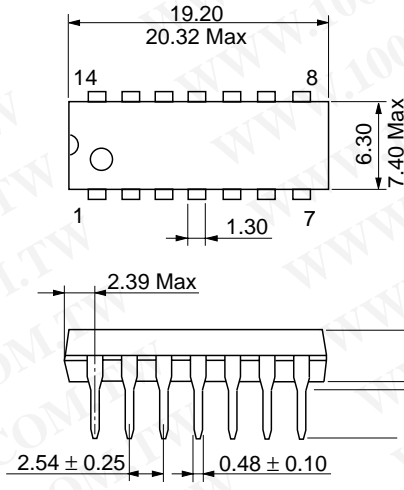

Hitachi Code	DP-14
JEDEC	Conforms
EIAJ	Conforms
Mass (reference value)	0.97 g

Cautions

1. Hitachi neither warrants nor grants licenses of any rights of Hitachi's or any third party's patent, copyright, trademark, or other intellectual property rights for information contained in this document. Hitachi bears no responsibility for problems that may arise with third party's rights, including intellectual property rights, in connection with use of the information contained in this document.
2. Products and product specifications may be subject to change without notice. Confirm that you have received the latest product standards or specifications before final design, purchase or use.
3. Hitachi makes every attempt to ensure that its products are of high quality and reliability. However, contact Hitachi's sales office before using the product in an application that demands especially high quality and reliability or where its failure or malfunction may directly threaten human life or cause risk of bodily injury, such as aerospace, aeronautics, nuclear power, combustion control, transportation, traffic, safety equipment or medical equipment for life support.
4. Design your application so that the product is used within the ranges guaranteed by Hitachi particularly for maximum rating, operating supply voltage range, heat radiation characteristics, installation conditions and other characteristics. Hitachi bears no responsibility for failure or damage when used beyond the guaranteed ranges. Even within the guaranteed ranges, consider normally foreseeable failure rates or failure modes in semiconductor devices and employ systemic measures such as fail-safes, so that the equipment incorporating Hitachi product does not cause bodily injury, fire or other consequential damage due to operation of the Hitachi product.
5. This product is not designed to be radiation resistant.
6. No one is permitted to reproduce or duplicate, in any form, the whole or part of this document without written approval from Hitachi.
7. Contact Hitachi's sales office for any questions regarding this document or Hitachi semiconductor products.

HITACHI

Hitachi, Ltd.

Semiconductor & Integrated Circuits.
Nippon Bldg., 2-6-2, Ohte-machi, Chiyoda-ku, Tokyo 100-0004, Japan
Tel: Tokyo (03) 3270-2111 Fax: (03) 3270-5109

URL North America : <http://semiconductor.hitachi.com/>
 Europe : <http://www.hitachi-eu.com/hel/ecg>
 Asia : <http://sicapac.hitachi-asia.com>
 Japan : <http://www.hitachi.co.jp/Sicd/indx.htm>

For further information write to:

Hitachi Semiconductor
(America) Inc.
179 East Tasman Drive,
San Jose, CA 95134
Tel: <1> (408) 433-1990
Fax: <1> (408) 433-0223

Hitachi Europe GmbH
Electronic Components Group
Dornacher Straße 3
D-85622 Feldkirchen, Munich
Germany
Tel: <49> (89) 9 9180-0
Fax: <49> (89) 9 29 30 00

Hitachi Europe Ltd.
Electronic Components Group.
Whitebrook Park
Lower Cookham Road
Maidenhead
Berkshire SL6 8YA, United Kingdom
Tel: <44> (1628) 585000
Fax: <44> (1628) 585160

Hitachi Asia Ltd.
Hitachi Tower
16 Collyer Quay #20-00,
Singapore 049318
Tel: <65>-538-6533/538-8577
Fax: <65>-538-6933/538-3877
URL: <http://www.hitachi.com.sg>

Hitachi Asia Ltd.
(Taipei Branch Office)
4/F, No. 167, Tun Hwa North Road,
Hung-Kuo Building,
Taipei (105), Taiwan
Tel: <886>-(2)-2718-3666
Fax: <886>-(2)-2718-8180
Telex: 23222 HAS-TP
URL: <http://www.hitachi.com.tw>

Hitachi Asia (Hong Kong) Ltd.
Group III (Electronic Components)
7/F., North Tower,
World Finance Centre,
Harbour City, Canton Road
Tsim Sha Tsui, Kowloon,
Hong Kong
Tel: <852>-(2)-735-9218
Fax: <852>-(2)-730-0281
URL: <http://www.hitachi.com.hk>

Copyright © Hitachi, Ltd., 2000. All rights reserved. Printed in Japan.
Colophon 2.0

HITACHI