

## Micropower, Single Supply, Rail-to-Rail Input-Output Instrumentation Amplifiers

The EL8171 and EL8172 are micropower instrumentation amplifiers optimized for single supply operation over the +2.4V to +5.5V range. Inputs and outputs can operate rail-to-rail. As with all instrumentation amplifiers, a pair of inputs provide very high common-mode rejection and are completely independent from a pair of feedback terminals. The feedback terminals allow zero input to be translated to any output offset, including ground. A feedback divider controls the overall gain of the amplifier.

The EL8172 is compensated for a gain of 100 or more, and the EL8171 is compensated for a gain of 10 or more. The EL8171 and EL8172 have PMOS input devices that provide sub-nA input bias currents.

The amplifiers can be operated from one lithium cell or two Ni-Cd batteries. The EL8171 and EL8172 input range goes from below ground to slightly above positive rail. The output stage swings completely to ground (ground sensing) or positive supply - no pull-up or pull-down resistors are needed.

### Pinout

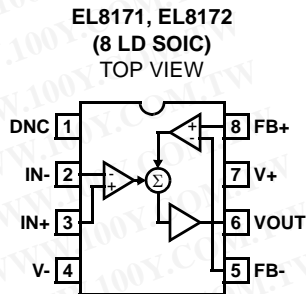

### Features

- 95µA maximum supply current
- Maximum input offset voltage
  - 300µV (EL8172)
  - 1500µV (EL8171)
- 50pA maximum input bias current
- 450kHz -3dB bandwidth (G = 10)
- 170kHz -3dB bandwidth (G = 100)
- Single supply operation
  - Input voltage range is rail-to-rail
  - Output swings rail-to-rail
  - Ground sensing
- Pb-free (RoHS compliant)

### Applications

- Battery- or solar-powered systems
- Strain gauges
- Current monitors
- Thermocouple amplifiers

### Ordering Information

PART NUMBER (Note)	PART MARKING	PACKAGE (Pb-free)	PKG. DWG. #
EL8171FSZ*	8171FSZ	8 Ld SOIC	MDP0027
EL8172FSZ*	8172FSZ	8 Ld SOIC	MDP0027

\*Add "-T7" suffix for tape and reel. Please refer to TB347 for details on reel specifications.

NOTE: These Intersil Pb-free plastic packaged products employ special Pb-free material sets, molding compounds/die attach materials, and 100% matte tin plate plus anneal (e3 termination finish, which is RoHS compliant and compatible with both SnPb and Pb-free soldering operations). Intersil Pb-free products are MSL classified at Pb-free peak reflow temperatures that meet or exceed the Pb-free requirements of IPC/JEDEC J STD-020.

# EL8171, EL8172

## Absolute Maximum Ratings (T<sub>A</sub> = +25°C)

Supply Voltage, V <sub>+</sub> .....	5.5V
Differential Input Current .....	5mA
Differential Input Voltage (EL8172) .....	0.5V
Differential Input Voltage (EL8171) .....	1.0V
ESD Rating	
Human Body Model .....	3kV

## Thermal Information

Thermal Resistance	θ <sub>JA</sub> (°C/W)
8 Ld SOIC Package .....	122
Output Short-Circuit Duration .....	Indefinite
Ambient Operating Temperature .....	-40°C to +125°C
Storage Temperature .....	-65°C to +150°C
Pb-Free Reflow Profile .....	see link below
	<a href="http://www.intersil.com/pbfree/Pb-FreeReflow.asp">http://www.intersil.com/pbfree/Pb-FreeReflow.asp</a>

**CAUTION:** Do not operate at or near the maximum ratings listed for extended periods of time. Exposure to such conditions may adversely impact product reliability and result in failures not covered by warranty.

**IMPORTANT NOTE:** All parameters having Min/Max specifications are guaranteed. Typical values are for information purposes only. Unless otherwise noted, all tests are at the specified temperature and are pulsed tests, therefore: T<sub>J</sub> = T<sub>C</sub> = T<sub>A</sub>

## Electrical Specifications V<sub>+</sub> = +5V, V<sub>-</sub> = GND, V<sub>CM</sub> = 1/2V<sub>+</sub>, R<sub>L</sub> = Open, T<sub>A</sub> = +25°C, unless otherwise specified. **Boldface limits apply over the operating temperature range, -40°C to +125°C.**

PARAMETER	DESCRIPTION	CONDITIONS	MIN (Note 1)	TYP	MAX (Note 1)	UNIT
<b>DC SPECIFICATIONS</b>						
V <sub>OS</sub>	Input Offset Voltage	EL8171	-1.5 <b>-2</b>	±0.47	1.5 <b>2</b>	mV
		EL8172	-0.3 <b>-0.7</b>	±0.07	0.3 <b>0.7</b>	mV
TCV <sub>OS</sub>	Input Offset Voltage Temperature Coefficient	EL8171		1.5		µV/°C
		EL8172		0.14		µV/°C
I <sub>OS</sub>	Input Offset Current, ± I <sub>N</sub> , ± I <sub>B</sub>		-25 <b>-500</b>	±4	25 <b>500</b>	pA pA
I <sub>B</sub>	Input Bias Current		-50 <b>-4</b>	±10	50 <b>4</b>	pA nA
V <sub>IN</sub>	Input Voltage Range	Guaranteed by CMRR test	0		5	V
CMRR	Common Mode Rejection Ratio	V <sub>CM</sub> = 0V to +5V	<b>75</b>	100		dB
PSRR	Power Supply Rejection Ratio	EL8171, V <sub>+</sub> = 2.4V to 5V	<b>75</b>	90		dB
		EL8172, V <sub>+</sub> = 2.4V to 5V	<b>75</b>	100		dB
E <sub>G</sub>	Gain Error	EL8171, R <sub>L</sub> = 100kΩ to 2.5V	<b>-0.7</b>	±0.15	<b>0.7</b>	%
		EL8172, R <sub>L</sub> = 100kΩ to 2.5V	-1 <b>-1.5</b>	±0.2	+1 <b>1.5</b>	% %
V <sub>OUT</sub>	Maximum Voltage Swing	Output low, 100kΩ to 2.5V		4	10 <b>10</b>	mV mV
		Output low, 1kΩ to 2.5V		0.13	0.2 <b>0.25</b>	V V
		Output high, 100kΩ to 2.5V	4.985 <b>4.980</b>	4.996		V V
		Output high, 1kΩ to GND	4.860 <b>4.750</b>	4.87		V V
I <sub>S</sub>	Supply Current		45 <b>38</b>	65	95 <b>110</b>	µA
V <sub>SUPPLY</sub>	Supply Operating Range	V <sub>+</sub> to V <sub>-</sub>	2.4		5.5	V
I <sub>O+</sub>	Output Source Current into 10Ω to V <sub>+</sub> /2	V <sub>+</sub> = 5V	23 <b>19</b>	32		mA
		V <sub>+</sub> = 2.4V	6 <b>4.5</b>	8		mA

## EL8171, EL8172

**Electrical Specifications**  $V_+ = +5V$ ,  $V_- = GND$ ,  $V_{CM} = 1/2V_+$ ,  $R_L = \text{Open}$ ,  $T_A = +25^\circ\text{C}$ , unless otherwise specified. **Boldface limits apply over the operating temperature range,  $-40^\circ\text{C}$  to  $+125^\circ\text{C}$ . (Continued)**

PARAMETER	DESCRIPTION	CONDITIONS		MIN (Note 1)	TYP	MAX (Note 1)	UNIT
$I_{O-}$	Output Sink Current into $10\Omega$ to $V_+/2$	$V_+ = 5V$		19 <b>15</b>	26		mA
		$V_+ = 2.4V$		5 <b>4</b>	7		mA
<b>AC SPECIFICATIONS</b>							
-3dB BW	-3dB Bandwidth	EL8171	Gain = 10V/V		450		kHz
			Gain = 20		210		kHz
			Gain = 50		66		kHz
			Gain = 100		33		kHz
		EL8172	Gain = 100		170		kHz
			Gain = 200		70		kHz
			Gain = 500		25		kHz
$e_N$	Input Noise Voltage	EL8171	$f = 0.1\text{Hz to }10\text{Hz}$		14		$\mu\text{V}_{P-P}$
		EL8172			10		$\mu\text{V}_{P-P}$
	Input Noise Voltage Density	EL8171	$f_0 = 1\text{kHz}$		220		$\text{nV}/\sqrt{\text{Hz}}$
		EL8172			80		$\text{nV}/\sqrt{\text{Hz}}$
$i_N$	Input Noise Current Density	EL8171, $f_0 = 1\text{kHz}$			0.9		$\text{pA}/\sqrt{\text{Hz}}$
		EL8172, $f_0 = 1\text{kHz}$			0.2		$\text{pA}/\sqrt{\text{Hz}}$
CMRR @ 60Hz	Input Common Mode Rejection Ratio	EL8171	$V_{CM} = 1V_{PP}$ , $R_L = 10k\Omega$ to $V_{CM}$		85		dB
		EL8172			100		dB
PSRR+ @ 120Hz	Power Supply Rejection Ratio ( $V_+$ )	EL8171	$V_+, V_- = \pm 2.5V$ , $V_{SOURCE} = 1V_{PP}$ , $R_L = 10k\Omega$ to $V_{CM}$		90		dB
		EL8172			92		dB
PSRR- @ 120Hz	Power Supply Rejection Ratio ( $V_-$ )	EL8171	$V_+, V_- = \pm 2.5V$ , $V_{SOURCE} = 1V_{PP}$ , $R_L = 10k\Omega$ to $V_{CM}$		97		dB
		EL8172			92		dB
<b>TRANSIENT RESPONSE</b>							
SR	Slew Rate	$R_L = 1k\Omega$ to GND		0.4 <b>0.35</b>	0.55	0.7 <b>0.7</b>	$\text{V}/\mu\text{s}$

**NOTES:**

- Parameters with MIN and/or MAX limits are 100% tested at  $+25^\circ\text{C}$ , unless otherwise specified. Temperature limits established by characterization and are not production tested.

**Typical Performance Curves**  $V_+ = 5V$ ,  $V_- = 0V$ ,  $V_{CM} = 2.5V$ ,  $R_L = \text{Open}$ , unless otherwise specified.

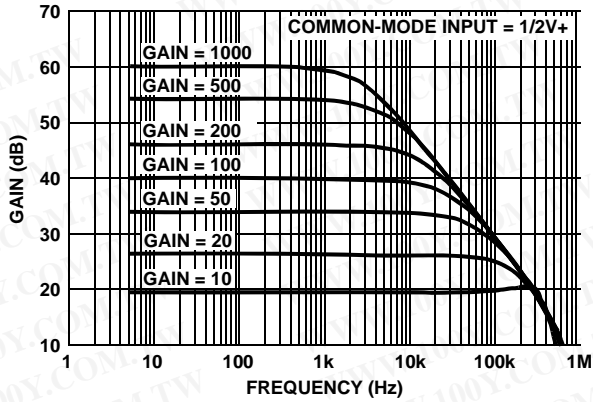

FIGURE 1. EL8171 FREQUENCY RESPONSE vs CLOSED LOOP GAIN

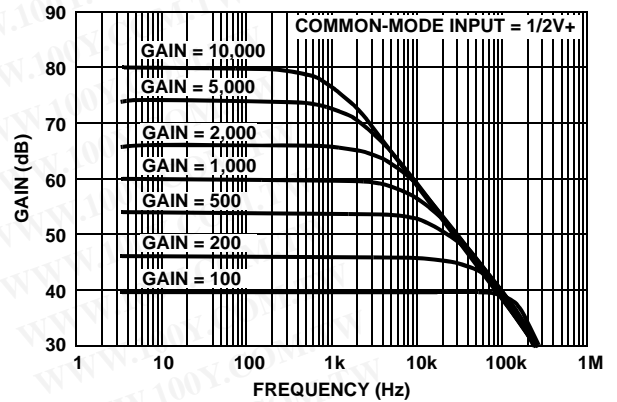

FIGURE 2. EL8172 FREQUENCY RESPONSE vs CLOSED LOOP GAIN

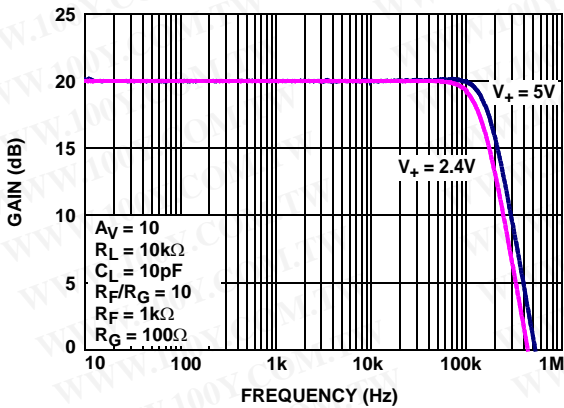

FIGURE 3. EL8171 FREQUENCY RESPONSE vs SUPPLY VOLTAGE

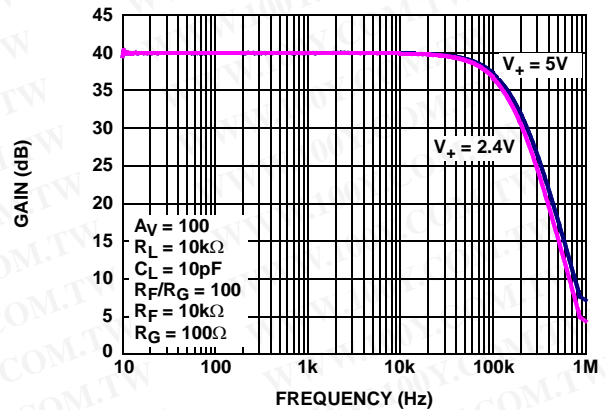

FIGURE 4. EL8172 FREQUENCY RESPONSE vs SUPPLY VOLTAGE

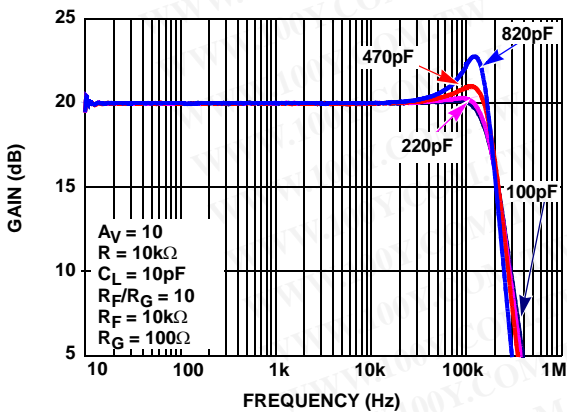

FIGURE 5. EL8171 FREQUENCY RESPONSE vs  $C_{LOAD}$

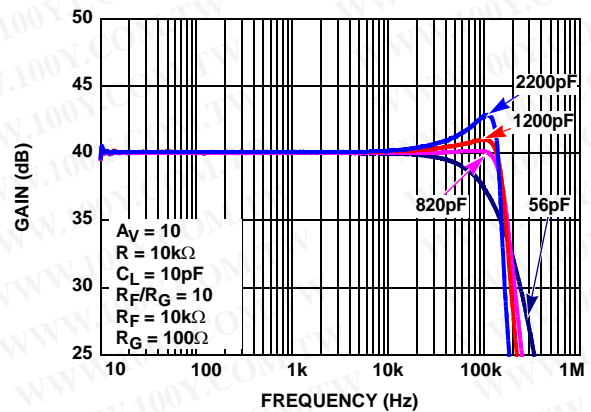

FIGURE 6. EL8172 FREQUENCY RESPONSE vs  $C_{LOAD}$

**Typical Performance Curves**  $V_+ = 5V, V_- = 0V, V_{CM} = 2.5V, R_L = \text{Open}$ , unless otherwise specified. (Continued)

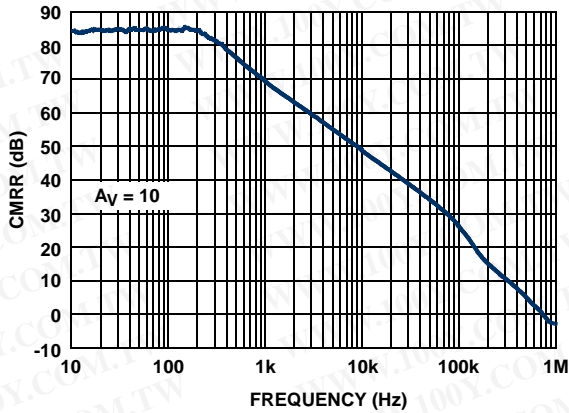

FIGURE 7. EL8171 CMRR vs FREQUENCY

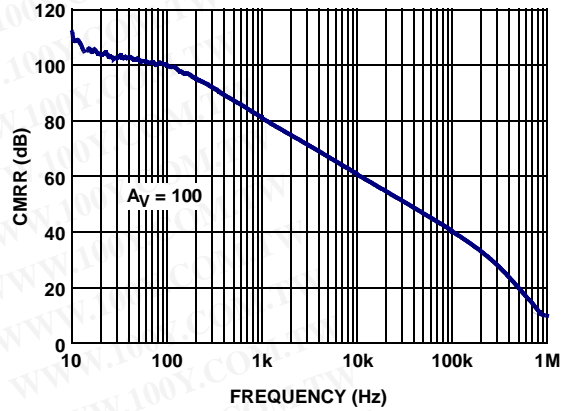

FIGURE 8. EL8172 CMRR vs FREQUENCY

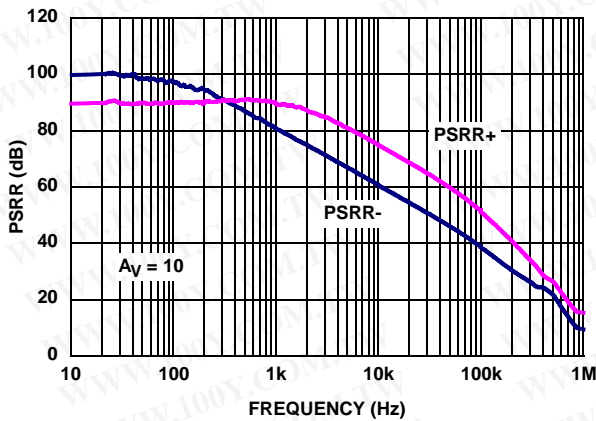

FIGURE 9. EL8171 PSRR vs FREQUENCY

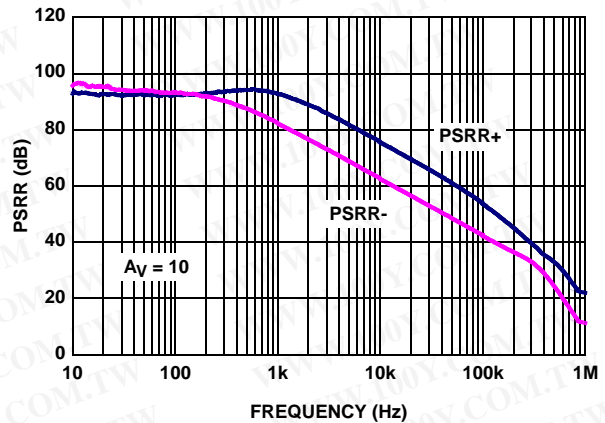

FIGURE 10. EL8172 PSRR vs FREQUENCY

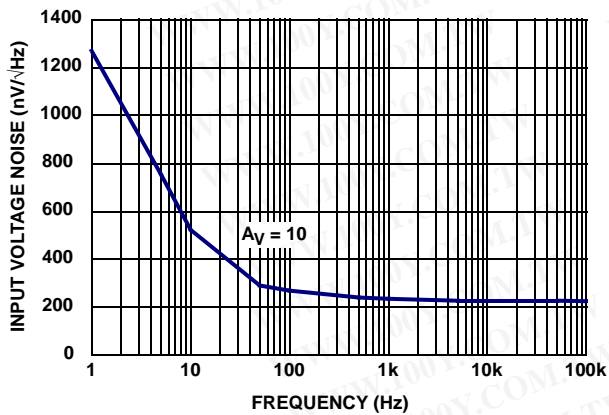

FIGURE 11. EL8171 VOLTAGE NOISE SPECTRAL DENSITY

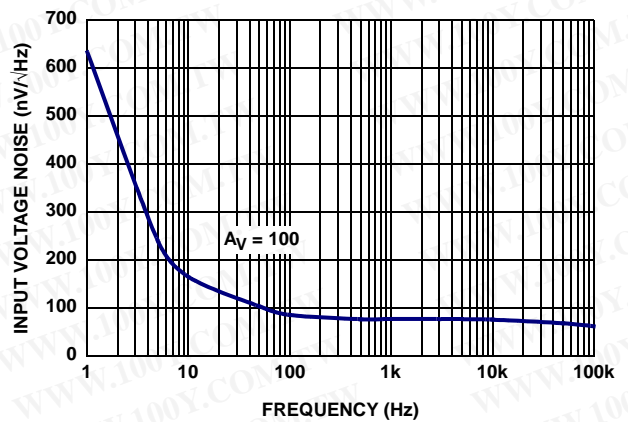

FIGURE 12. EL8172 VOLTAGE NOISE SPECTRAL DENSITY

**Typical Performance Curves**  $V_+ = 5V, V_- = 0V, V_{CM} = 2.5V, R_L = \text{Open}$ , unless otherwise specified. (Continued)

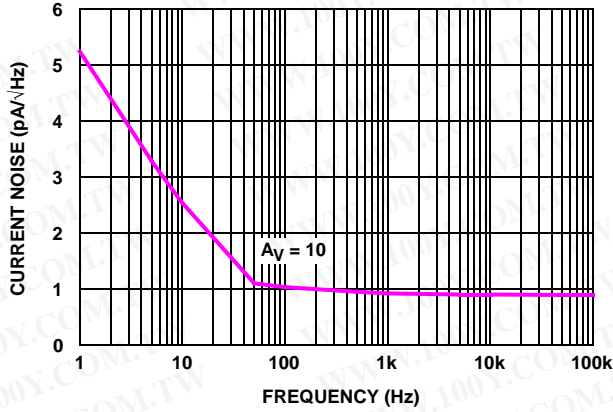

FIGURE 13. EL8171 CURRENT NOISE SPECTRAL DENSITY

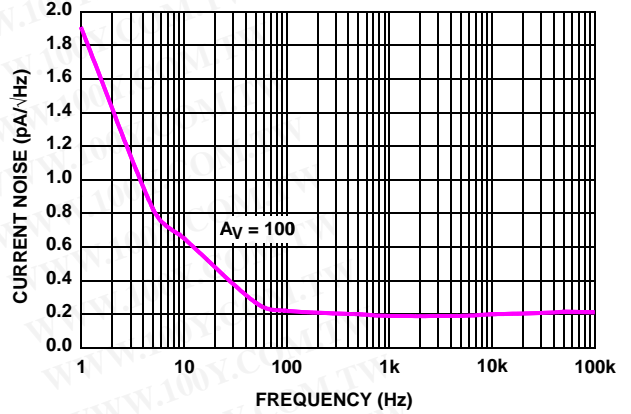

FIGURE 14. EL8172 CURRENT NOISE SPECTRAL DENSITY

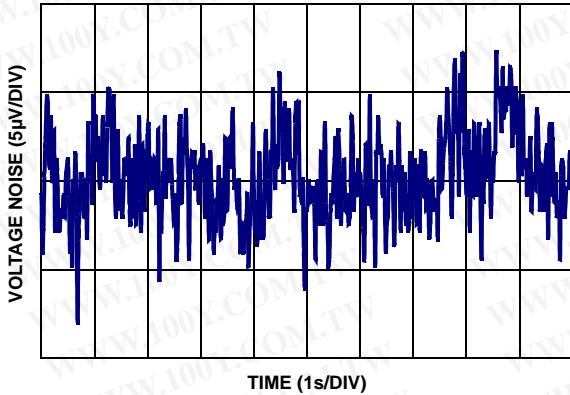

FIGURE 15. EL8171 0.1Hz TO 10Hz INPUT VOLTAGE NOISE (GAIN = 10)

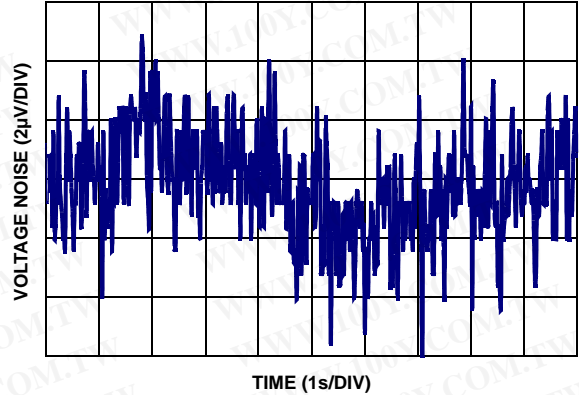

FIGURE 16. EL8172 0.1Hz TO 10Hz INPUT VOLTAGE NOISE (GAIN = 100)

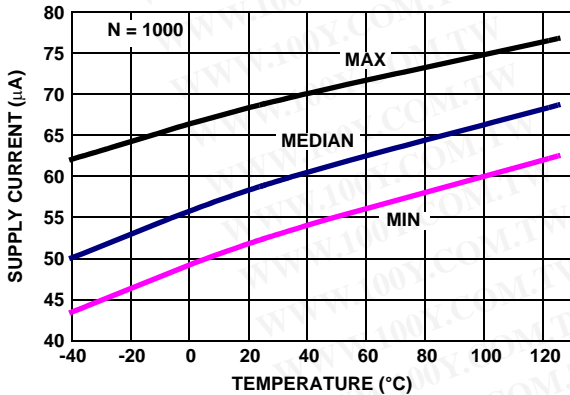

FIGURE 17. EL8171 SUPPLY CURRENT vs TEMPERATURE,  $V_+, V_- = \pm 2.5V, V_{IN} = 0V$

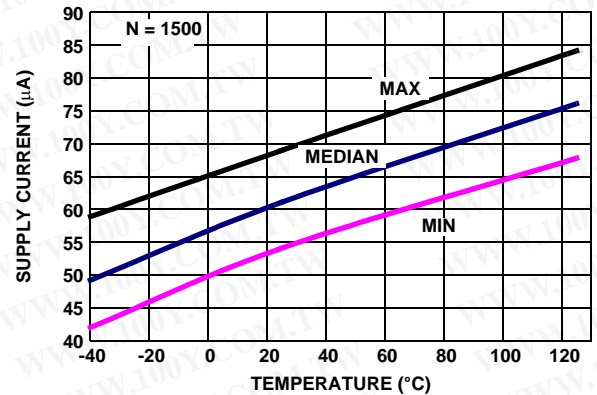

FIGURE 18. EL8172 SUPPLY CURRENT vs TEMPERATURE,  $V_+, V_- = \pm 2.5V, V_{IN} = 0V$

**Typical Performance Curves**  $V_+ = 5V, V_- = 0V, V_{CM} = 2.5V, R_L = \text{Open}$ , unless otherwise specified. (Continued)

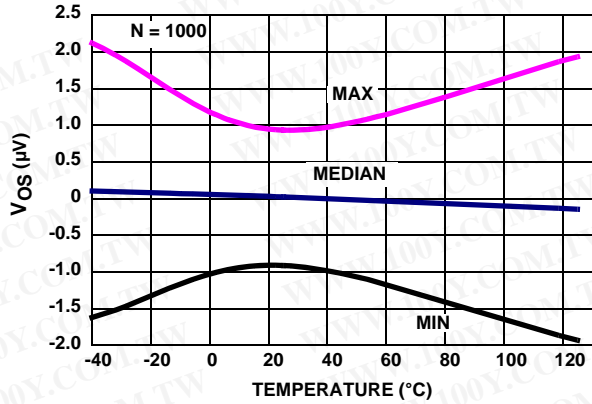

FIGURE 19. EL8171  $V_{OS}$  vs TEMPERATURE,  $V_+, V_- = \pm 2.5V, V_{IN} = 0V$

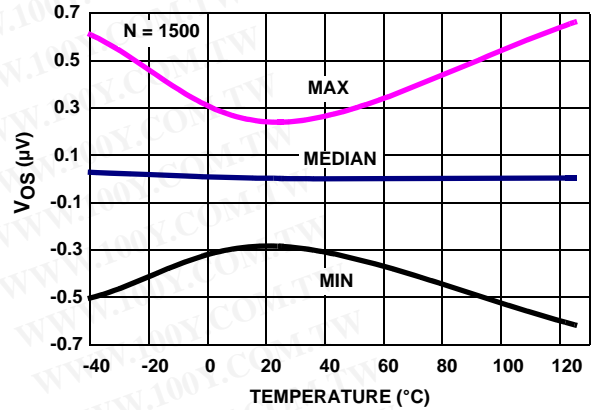

FIGURE 20. EL8172  $V_{OS}$  vs TEMPERATURE,  $V_+, V_- = \pm 2.5V, V_{IN} = 0V$

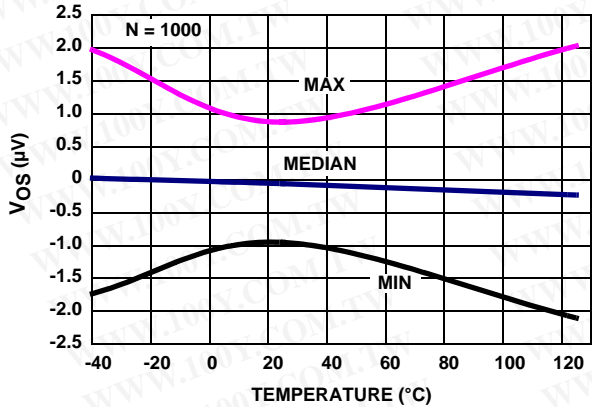

FIGURE 21. EL8171  $V_{OS}$  vs TEMPERATURE,  $V_+, V_- = \pm 1.2V, V_{IN} = 0V$

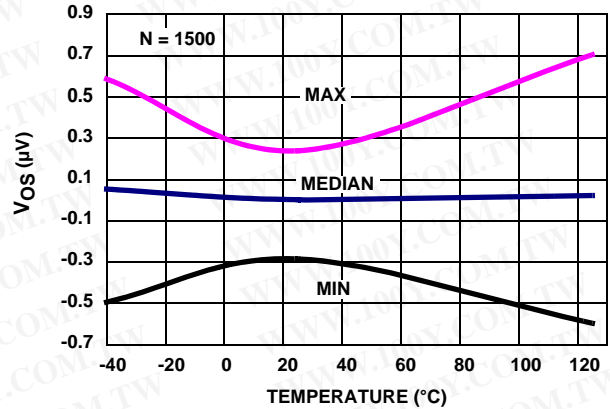

FIGURE 22. EL8172  $V_{OS}$  vs TEMPERATURE,  $V_+, V_- = \pm 1.2V, V_{IN} = 0V$

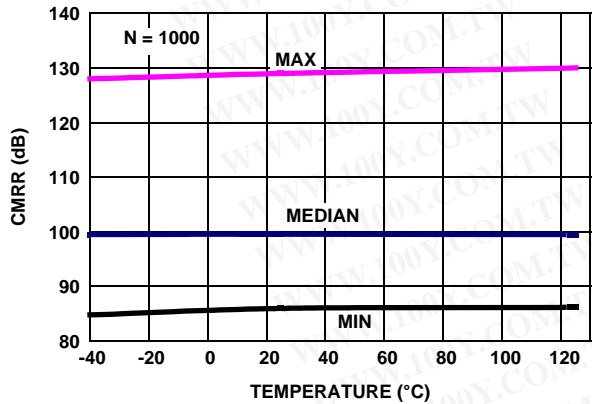

FIGURE 23. EL8171 CMRR vs TEMPERATURE,  $V_{CM} = +2.5V \text{ TO } -2.5V, V_+, V_- = \pm 2.5V$

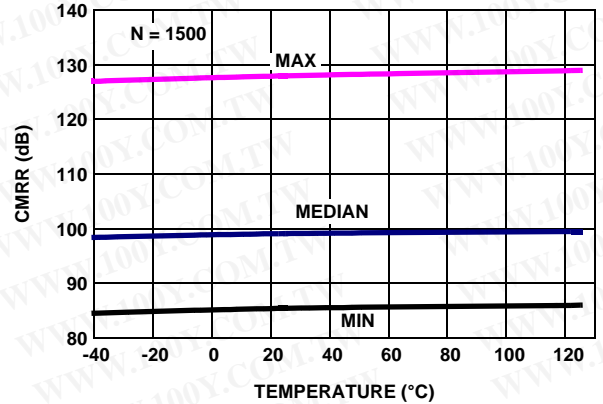

FIGURE 24. EL8172 CMRR vs TEMPERATURE,  $V_{CM} = +2.5V \text{ TO } -2.5V, V_+, V_- = \pm 2.5V$

**Typical Performance Curves**  $V_+ = 5V$ ,  $V_- = 0V$ ,  $V_{CM} = 2.5V$ ,  $R_L = \text{Open}$ , unless otherwise specified. (Continued)

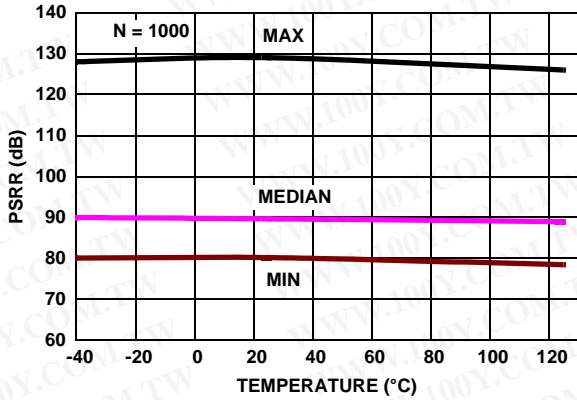

FIGURE 25. EL8171 PSRR vs TEMPERATURE,  $V_+$ ,  $V_- = \pm 1.2V$  TO  $\pm 2.5V$

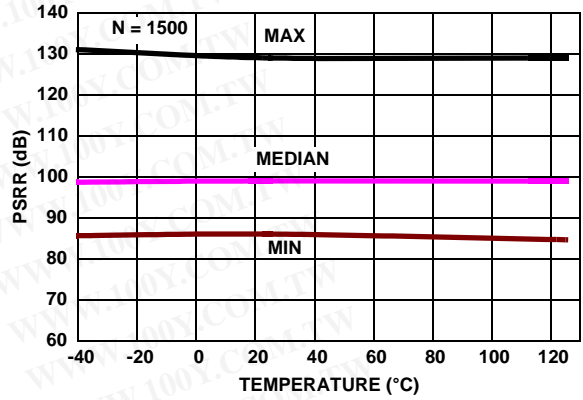

FIGURE 26. EL8172 PSRR vs TEMPERATURE,  $V_+$ ,  $V_- = \pm 1.2V$  TO  $\pm 2.5V$

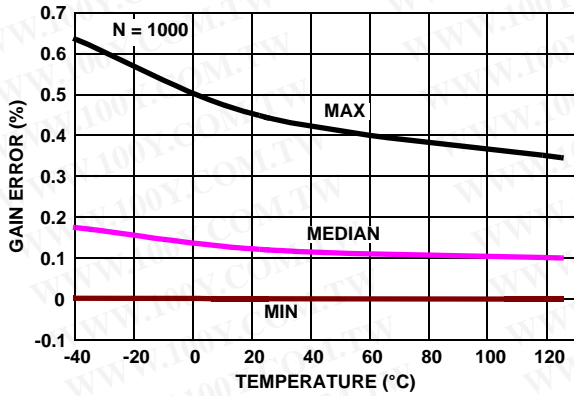

FIGURE 27. EL8171 % GAIN ERROR vs TEMPERATURE,  $R_L = 100k$

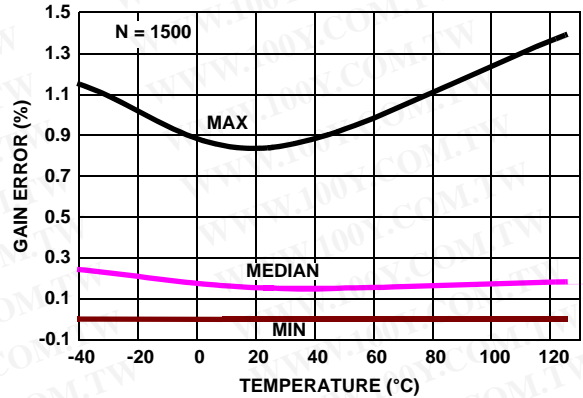

FIGURE 28. EL8172 % GAIN ERROR vs TEMPERATURE,  $R_L = 100k$

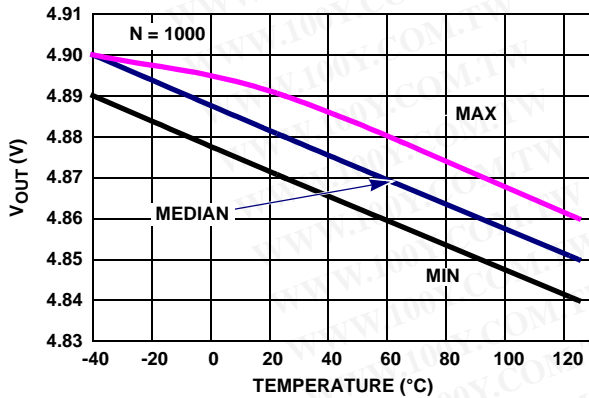

FIGURE 29. EL8171  $V_{OUT}$  HIGH vs TEMPERATURE,  $R_L = 1k$ ,  $V_+$ ,  $V_- = \pm 2.5V$

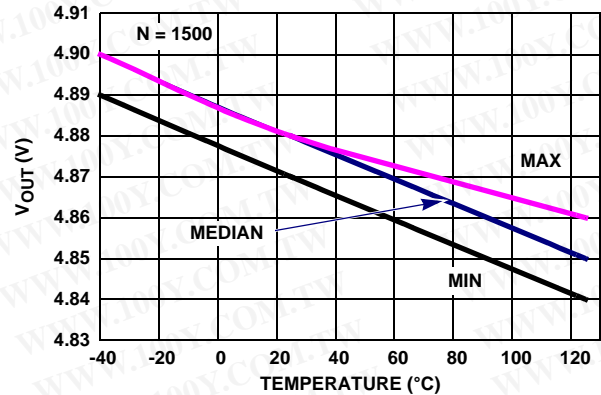

FIGURE 30. EL8172  $V_{OUT}$  HIGH vs TEMPERATURE,  $R_L = 1k$ ,  $V_+$ ,  $V_- = \pm 2.5V$



**Typical Performance Curves**  $V_+ = 5V$ ,  $V_- = 0V$ ,  $V_{CM} = 2.5V$ ,  $R_L = \text{Open}$ , unless otherwise specified. (Continued)

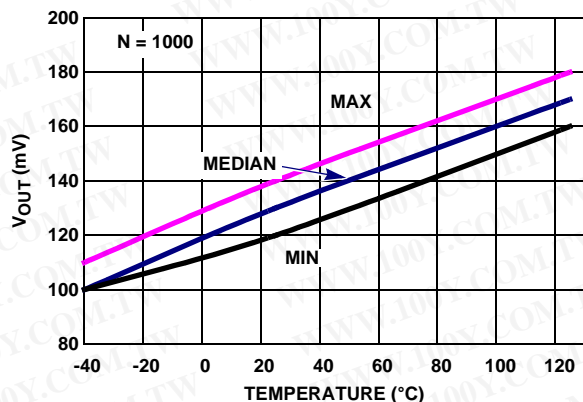

FIGURE 31. EL8171  $V_{OUT}$  LOW vs TEMPERATURE,  $R_L = 1k$ ,  $V_+ = 5V$ ,  $V_- = 0V$

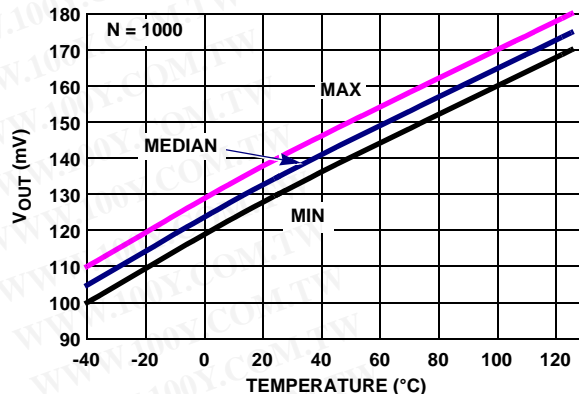

FIGURE 32. EL8172  $V_{OUT}$  LOW vs TEMPERATURE,  $R_L = 1k$ ,  $V_+ = 5V$ ,  $V_- = 0V$

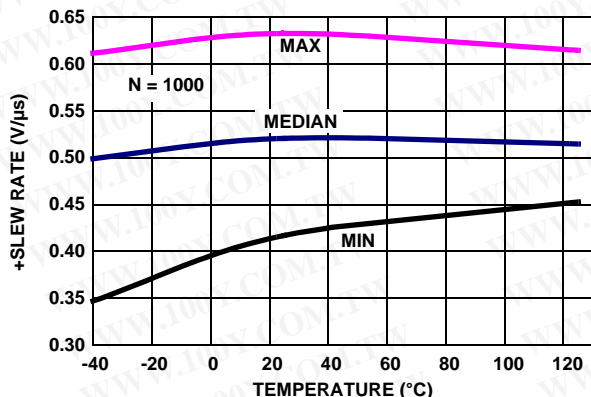

FIGURE 33. EL8171 +SLEW RATE vs TEMPERATURE, INPUT =  $\pm 0.015V$  @ GAIN + 100

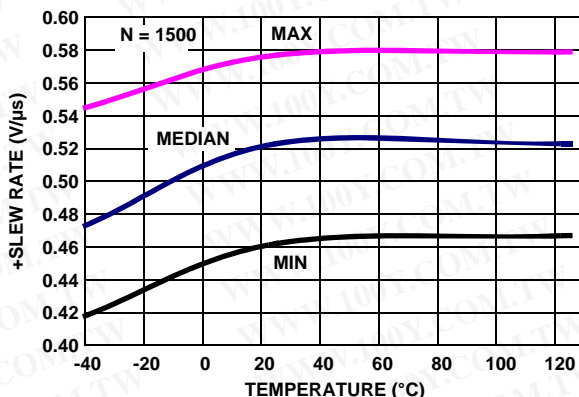

FIGURE 34. EL8172 +SLEW RATE vs TEMPERATURE, INPUT =  $\pm 0.015V$  @ GAIN + 100

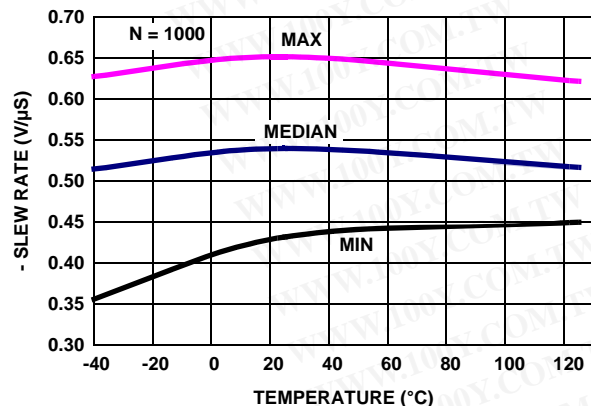

FIGURE 35. EL8171 -SLEW RATE vs TEMPERATURE, INPUT =  $\pm 0.015V$  @ GAIN + 100

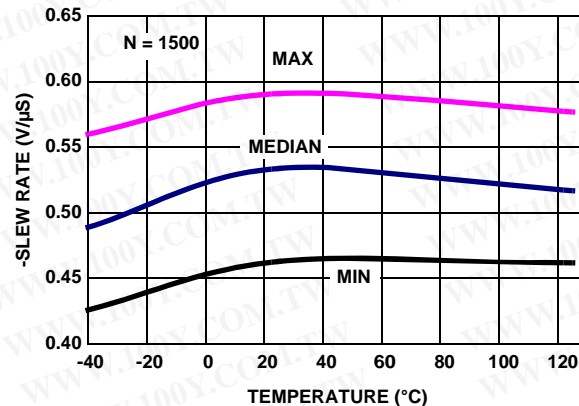
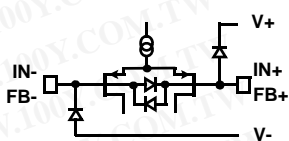

FIGURE 36. EL8172 -SLEW RATE vs TEMPERATURE, INPUT =  $\pm 0.015V$  @ GAIN + 100

Pin Descriptions

EL8171/EL8172	PIN NAME	EQUIVALENT CIRCUIT	PIN FUNCTION
1	DNC		Do Not Connect; Internal connection - Must be left floating.
2	IN-	Circuit 1A, Circuit 1B	High impedance input terminals. EL8172 input circuit is shown in Circuit 1A, and the EL8171 input circuit is shown in Circuit 1B. EL8171: to avoid offset drift, it is recommended that the terminals are not overdriven beyond 1V and the input current must never exceed 5mA.
3	IN+	Circuit 1A, Circuit 1B	
4	V-	Circuit 3	Negative supply terminal.
5	FB-	Circuit 1A, Circuit 1B	High impedance feedback terminals. EL8172 input circuit is shown in Circuit 1A, and the EL8171 input circuit is shown in Circuit 1B. EL8171: to avoid offset drift, it is recommended that the terminals are not overdriven beyond 1V and the input current must never exceed 5mA.
8	FB+	Circuit 1A, Circuit 1B	
7	V+	Circuit 3	Positive supply terminal.
6	VOU	Circuit 2	Output Voltage.



CIRCUIT 1A

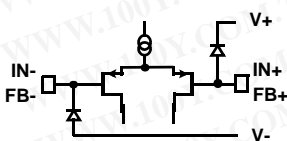

CIRCUIT 1B

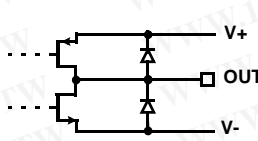

CIRCUIT 2

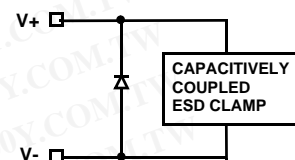

CIRCUIT 3

Description of Operation and Application Information

Product Description

The EL8171 and EL8172 are micropower instrumentation amplifiers (in-amps) which deliver rail-to-rail input amplification and rail-to-rail output swing on a single 2.4V to 5.5V supply. The EL8171 and EL8172 also deliver excellent DC and AC specifications while consuming only 65µA typical supply current. Because EL8171 and EL8172 provide an independent pair of feedback terminals to set the gain and to adjust the output level, these in-amps achieve high common-mode rejection ratio regardless of the tolerance of the gain setting resistors. The EL8171 is internally compensated for a minimum closed loop gain of 10 or greater, well suited for moderate to high gains. For higher gains, the EL8172 is internally compensated for a minimum gain of 100.

Input Protection

All input and feedback terminals of the EL8171 and EL8172 have internal ESD protection diodes to both positive and negative supply rails, limiting the input voltage to within one diode drop beyond the supply rails. The inverting inputs and FB- inputs have ESD diodes to the V-rail, and the non-inverting inputs and FB+ terminals have ESD diodes to the V+ rail. The EL8172 has additional back-to-back diodes across the input terminals and also across the feedback terminals. If overdriving the inputs is necessary, the external input current must never exceed 5mA. On the other hand, the EL8171 has no clamps to limit the differential voltage on the input terminals allowing

higher differential input voltages at lower gain applications. It is recommended however, that the input terminals of the EL8171 are not overdriven beyond 1V to avoid offset drift. An external series resistor may be used as an external protection to limit excessive external voltage and current from damaging the inputs.

Input Stage and Input Voltage Range

The input terminals (IN+ and IN-) of the EL8171 and EL8172 are single differential pair P-MOSFET devices aided by an Input Range Enhancement Circuit (IREC) to increase the headroom of operation of the common-mode input voltage. The feedback terminals (FB+ and FB-) also have a similar topology. As a result, the input common-mode voltage range of both the EL8171 and EL8172 is rail-to-rail. These in-amps are able to handle input voltages that are at or slightly beyond the supply and ground making these in-amps well suited for single 5V or 3.3V low voltage supply systems. There is no need to move the common-mode input of the in-amps to achieve symmetrical input voltage.

Output Stage and Output Voltage Range

A pair of complementary MOSFET devices drive the output V<sub>OUT</sub> to within a few mV of the supply rails. At a 100kΩ load, the PMOS sources current and pulls the output up to 4mV below the positive supply, while the NMOS sinks current and pulls the output down to 4mV above the negative supply, or ground in the case of a single supply operation. The current sinking and sourcing capability of the EL8171 and EL8172 are internally limited to less than 35mA.

### Gain Setting

$V_{IN}$ , the potential difference across  $IN+$  and  $IN-$ , is replicated (less the input offset voltage) across  $FB+$  and  $FB-$ . The obsession of the EL8171 and EL8172 in-amp is to maintain the differential voltage across  $FB+$  and  $FB-$  equal to  $IN+$  and  $IN-$ ;  $(FB+ - FB-) = (IN+ - IN-)$ . Consequently, the transfer function can be derived. The gain of the EL8171 and EL8172 is set by two external resistors, the feedback resistor  $R_F$ , and the gain resistor  $R_G$ .

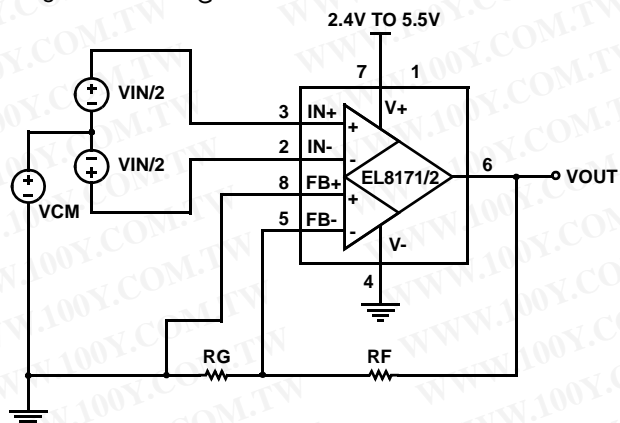

FIGURE 37. CIRCUIT 1 - GAIN IS BY EXTERNAL RESISTORS  $R_F$  AND  $R_G$

$$V_{OUT} = \left(1 + \frac{R_F}{R_G}\right) V_{IN} \quad (\text{EQ. 1})$$

In Figure 37, the  $FB+$  pin and one end of resistor  $R_G$  are connected to GND. With this configuration, Equation 1 is only true for a positive swing in  $V_{IN}$ ; negative input swings will be ignored and the output will be at ground.

### Reference Connection

Unlike a three-op amp instrumentation amplifier, a finite series resistance seen at the REF terminal does not degrade the EL8171 and EL8172's high CMRR performance, eliminating the need for an additional external buffer amplifier. Circuit 2 (Figure 38) uses the  $FB+$  pin to provide a high impedance REF terminal.

The  $FB+$  pin is used as a REF terminal to center or to adjust the output. Because the  $FB+$  pin is a high impedance input, an economical resistor divider can be used to set the voltage at the REF terminal without degrading or affecting the CMRR performance. Any voltage applied to the REF terminal will shift  $V_{OUT}$  by  $V_{REF}$  times the closed loop gain, which is set by resistors  $R_F$  and  $R_G$ . See Circuit 2 (Figure 38). Note that any noise or unwanted signals on the reference supply will be amplified at the output according to Equation 2.

The  $FB+$  pin can also be connected to the other end of resistor,  $R_G$ . See Circuit 3 (Figure 39). Keeping the basic concept that the EL8171 and EL8172 in-amps maintain constant differential voltage across the input terminals and feedback terminals ( $IN+ - IN- = FB+ - FB-$ ), the transfer function of Circuit 3 can be derived. Note that the  $V_{REF}$  gain term is eliminated and

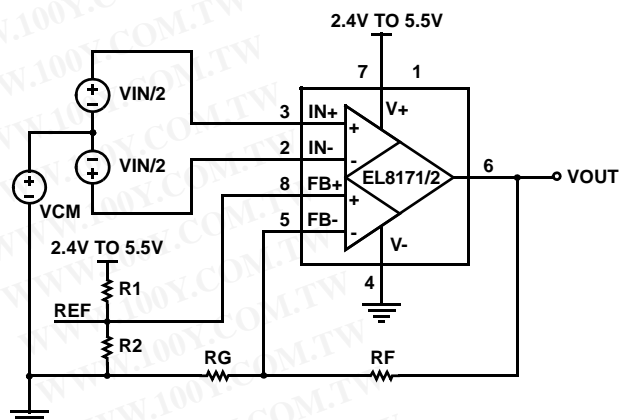

FIGURE 38. CIRCUIT 2 - GAIN SETTING AND REFERENCE CONNECTION

$$V_{OUT} = \left(1 + \frac{R_F}{R_G}\right) (V_{IN}) + \left(1 + \frac{R_F}{R_G}\right) (V_{REF}) \quad (\text{EQ. 2})$$

susceptibility to external noise is reduced, however the  $V_{REF}$  source must be capable of sourcing or sinking the feedback current from  $V_{OUT}$  through  $R_F$  and  $R_G$ .

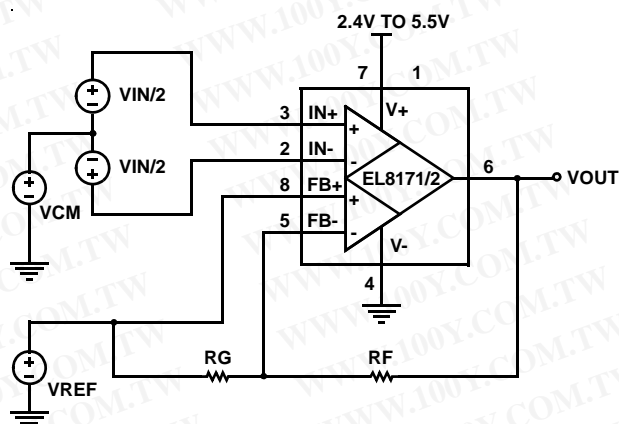

FIGURE 39. CIRCUIT 3 - REFERENCE CONNECTION WITH AN AVAILABLE  $V_{REF}$

$$V_{OUT} = \left(1 + \frac{R_F}{R_G}\right) (V_{IN}) + (V_{REF}) \quad (\text{EQ. 3})$$

### External Resistor Mismatches

Because of the independent pair of feedback terminals provided by the EL8171 and EL8172, the CMRR is not degraded by any resistor mismatches. Hence, unlike a three op amp and especially a two op amp in-amp, the EL8171 and EL8172 reduce the cost of external components by allowing the use of 1% or more tolerance resistors without sacrificing CMRR performance. The EL8171 and EL8172 CMRR will be maintained regardless of the tolerance of the resistors used.

### Gain Error and Accuracy

The EL8172 has a Gain Error (EG) of 0.2% typical. The EL8171 has an EG of 0.15% typical. The gain error indicated in the "Electrical Specifications" table on page 2 is the inherent gain error of the EL8171 and EL8172 and does not include

the gain error contributed by the resistors. There is an additional gain error due to the tolerance of the resistors used. The resulting non-ideal transfer function effectively becomes:

$$V_{OUT} = \left(1 + \frac{R_F}{R_G}\right) \times [1 - (E_{RG} + E_{RF} + E_G)] \times V_{IN} \quad (\text{EQ. 4})$$

Where:

$E_{RG}$  = Tolerance of  $R_G$

$E_{RF}$  = Tolerance of  $R_F$

$E_G$  = Gain Error of the EL8171 or EL8172

The term  $[1 - (E_{RG} + E_{RF} + E_G)]$  is the deviation from the theoretical gain. Thus,  $(E_{RG} + E_{RF} + E_G)$  is the total gain error. For example, if 1% resistors are used for the EL8171, the total gain error would be:

$$\begin{aligned} &= \pm(E_{RG} + E_{RF} + E_G(\text{typical})) \\ &= \pm(0.01 + 0.01 + 0.003) \\ &= \pm 2.3\% \end{aligned} \quad (\text{EQ. 5})$$

### Power Dissipation

It is possible to exceed the +150°C maximum junction temperatures under certain load and power-supply conditions. It is therefore important to calculate the maximum junction temperature ( $T_{JMAX}$ ) for all applications to determine if power supply voltages, load conditions, or package type need to be modified to remain in the safe operating area. These parameters are related in Equation 6:

$$T_{JMAX} = T_{MAX} + (\theta_{JA} \times PD_{MAXTOTAL}) \quad (\text{EQ. 6})$$

where:

- $PD_{MAXTOTAL}$  is the sum of the maximum power dissipation of each amplifier in the package ( $PD_{MAX}$ )
- $PD_{MAX}$  for each amplifier can be calculated as shown in Equation 7:

$$PD_{MAX} = 2 \times V_S \times I_{SMAX} + (V_S - V_{OUTMAX}) \times \frac{V_{OUTMAX}}{R_L} \quad (\text{EQ. 7})$$

where:

- $T_{MAX}$  = Maximum ambient temperature
- $\theta_{JA}$  = Thermal resistance of the package
- $PD_{MAX}$  = Maximum power dissipation of 1 amplifier
- $V_S$  = Supply voltage (Magnitude of  $V_+$  and  $V_-$ )
- $I_{SMAX}$  = Maximum supply current of 1 amplifier
- $V_{OUTMAX}$  = Maximum output voltage swing of the application
- $R_L$  = Load resistance

All Intersil U.S. products are manufactured, assembled and tested utilizing ISO9000 quality systems. Intersil Corporation's quality certifications can be viewed at [www.intersil.com/design/quality](http://www.intersil.com/design/quality)

*Intersil products are sold by description only. Intersil Corporation reserves the right to make changes in circuit design, software and/or specifications at any time without notice. Accordingly, the reader is cautioned to verify that data sheets are current before placing orders. Information furnished by Intersil is believed to be accurate and reliable. However, no responsibility is assumed by Intersil or its subsidiaries for its use; nor for any infringements of patents or other rights of third parties which may result from its use. No license is granted by implication or otherwise under any patent or patent rights of Intersil or its subsidiaries.*

For information regarding Intersil Corporation and its products, see [www.intersil.com](http://www.intersil.com)

Small Outline Package Family (SO)

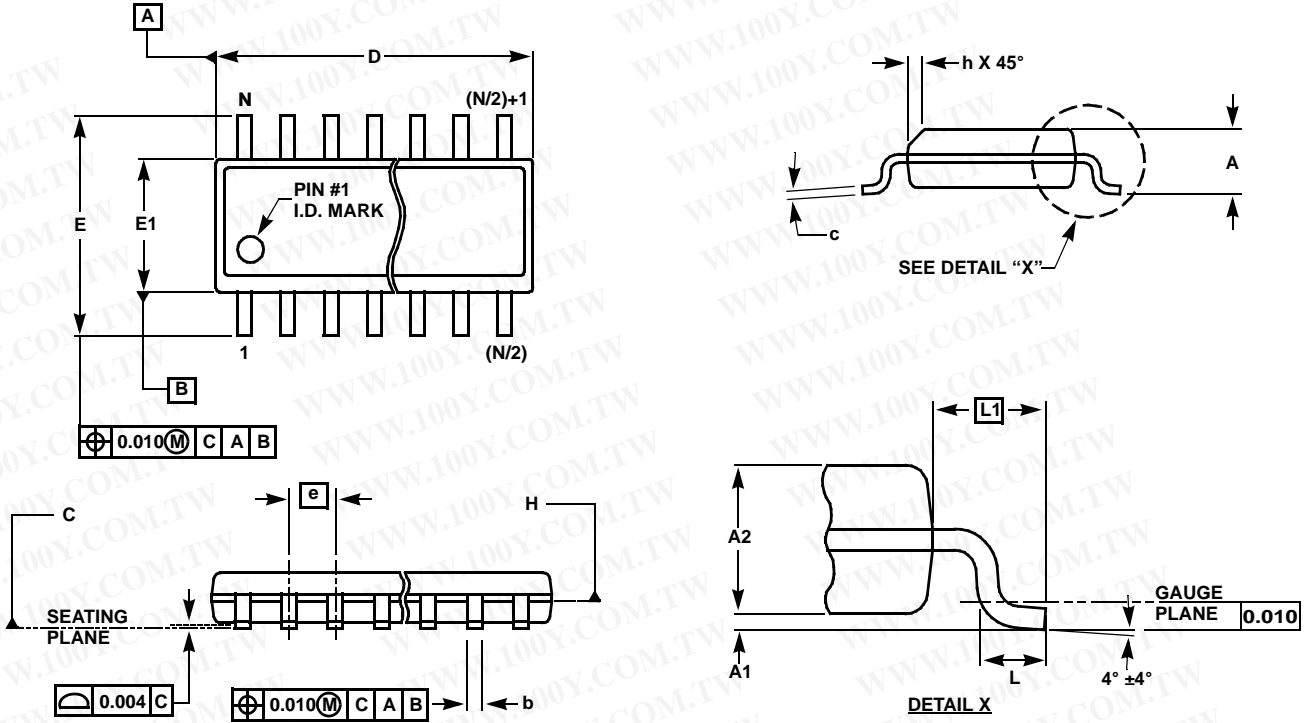

MDP0027

SMALL OUTLINE PACKAGE FAMILY (SO)

SYMBOL	INCHES							TOLERANCE	NOTES
	SO-8	SO-14	SO16 (0.150")	SO16 (0.300") (SOL-16)	SO20 (SOL-20)	SO24 (SOL-24)	SO28 (SOL-28)		
A	0.068	0.068	0.068	0.104	0.104	0.104	0.104	MAX	-
A1	0.006	0.006	0.006	0.007	0.007	0.007	0.007	±0.003	-
A2	0.057	0.057	0.057	0.092	0.092	0.092	0.092	±0.002	-
b	0.017	0.017	0.017	0.017	0.017	0.017	0.017	±0.003	-
c	0.009	0.009	0.009	0.011	0.011	0.011	0.011	±0.001	-
D	0.193	0.341	0.390	0.406	0.504	0.606	0.704	±0.004	1, 3
E	0.236	0.236	0.236	0.406	0.406	0.406	0.406	±0.008	-
E1	0.154	0.154	0.154	0.295	0.295	0.295	0.295	±0.004	2, 3
e	0.050	0.050	0.050	0.050	0.050	0.050	0.050	Basic	-
L	0.025	0.025	0.025	0.030	0.030	0.030	0.030	±0.009	-
L1	0.041	0.041	0.041	0.056	0.056	0.056	0.056	Basic	-
h	0.013	0.013	0.013	0.020	0.020	0.020	0.020	Reference	-
N	8	14	16	16	20	24	28	Reference	-

Rev. M 2/07

NOTES:

1. Plastic or metal protrusions of 0.006" maximum per side are not included.
2. Plastic interlead protrusions of 0.010" maximum per side are not included.
3. Dimensions "D" and "E1" are measured at Datum Plane "H".
4. Dimensioning and tolerancing per ASME Y14.5M-1994