

## Micropower, Single Supply, Precision Op Amp

 勝特力材料 886-3-5753170  
 勝特力电子(上海) 86-21-34970699  
 勝特力电子(深圳) 86-755-83298787  
 Http://www.100y.com.tw

### FEATURES

- 60 $\mu$ A Max Supply Current
- 40 $\mu$ V Max Offset Voltage
- 350pA Max Offset Current
- 0.5 $\mu$ V<sub>P-P</sub> 0.1Hz to 10Hz Voltage Noise
- 2.5pA<sub>P-P</sub> 0.1Hz to 10Hz Current Noise
- 0.4 $\mu$ V/ $^{\circ}$ C Offset Voltage Drift
- 250kHz Gain-Bandwidth Product
- 0.12V/ $\mu$ s Slew Rate
- Single Supply Operation
  - Input Voltage Range Includes Ground
  - Output Swings to Ground while Sinking Current
  - No Pull-Down Resistors are Needed
- Output Sources and Sinks 5mA Load Current

### APPLICATIONS

- Replaces OP-07, OP-77, AD707, LT1001, LT1012 at 10 to 60 Times Lower Power
- Battery or Solar Powered Systems
- 4mA to 20mA Current Loops
- Two Terminal Current Source
- Megaohm Source Resistance Difference Amplifier

 LTC and LT are registered trademarks of Linear Technology Corporation.

### DESCRIPTION

The LT<sup>®</sup>1077 is a micropower precision operational amplifier optimized for single supply operation at 5V. In addition,  $\pm$ 15V specifications are provided.

Micropower performance of competing devices is achieved at the expense of seriously degrading precision, noise, speed, and output drive specifications. The LT1077 reduces supply current without sacrificing other parameters. The offset voltage achieved is the lowest of any micropower op amp. Offset current, voltage and current noise, slew rate and gain-bandwidth product are all two to ten times better than on previous micropower op amps.

The 1/f corner of the voltage noise spectrum is at 0.7Hz. This results in low frequency (0.1Hz to 10Hz) noise performance which can only be found on devices with an order of magnitude higher supply current.

The LT1077 is completely plug-in compatible (including nulling) with all industry standard precision op amps. Thus, it can replace these precision op amps in many applications without sacrificing performance, yet with significant power savings.

The LT1077 can be operated from one lithium cell or two Ni-Cad batteries. The input range goes below ground. The all-NPN output stage swings to ground while sinking current—no pull-down resistors are needed.

For dual and quad op amps with similar specifications please see the LT1078/LT1079 datasheet.

### TYPICAL APPLICATION

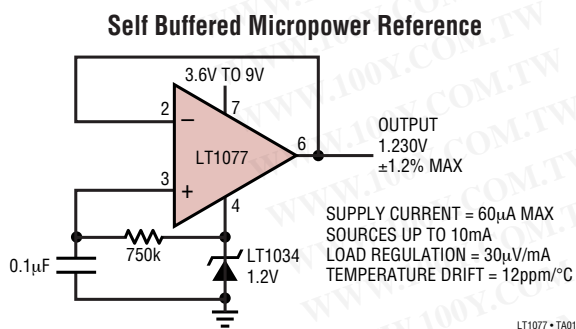

Distribution of Input Offset Voltage

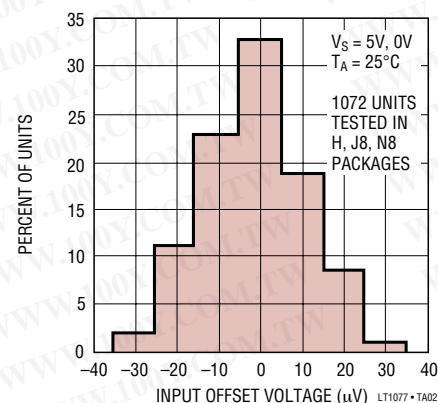

1077fa

**ABSOLUTE MAXIMUM RATINGS** (Note 1)

Supply Voltage .....  $\pm 22V$   
 Differential Input Voltage .....  $\pm 30V$   
 Input Voltage ..... Equal to Positive Supply Voltage  
 Input Voltage ..... 5V Below Negative Supply Voltage  
 Output Short-Circuit Duration ..... Indefinite

Operating Temperature Range

LT1077AM/LT1077M (**OBSOLETE**)....  $-55^{\circ}C$  to  $125^{\circ}C$

LT1077AI/LT1077I.....  $-40^{\circ}C$  to  $85^{\circ}C$

LT1077AC/LT1077C/LT1077S8 .....  $0^{\circ}C$  to  $70^{\circ}C$

Storage Temperature Range .....  $-65^{\circ}C$  to  $150^{\circ}C$

Lead Temperature (Soldering, 10 sec).....  $300^{\circ}C$

**PACKAGE/ORDER INFORMATION**

<p>TOP VIEW  <math>V_{OS}</math> TRIM  <math>V_{OS}</math> TRIM  <math>V^+</math>  <math>V^-</math>          H PACKAGE          8-LEAD TO-5 METAL CAN  <math>T_{JMAX} = 150^{\circ}C</math>, <math>\theta_{JA} = 150^{\circ}C/W</math>, <math>\theta_{JC} = 45^{\circ}C/W</math></p>	<p>TOP VIEW  <math>V_{OS}</math> TRIM  <math>V_{OS}</math> TRIM  <math>V^+</math>  <math>V^-</math>          J8 PACKAGE          8-LEAD CERDIP  <math>T_{JMAX} = 150^{\circ}C</math>, <math>\theta_{JA} = 100^{\circ}C/W</math></p>	<p>TOP VIEW  <math>V_{OS}</math> TRIM  <math>V_{OS}</math> TRIM  <math>V^+</math>  <math>V^-</math>          N8 PACKAGE          8-LEAD PDIP  <math>T_{JMAX} = 100^{\circ}C</math>, <math>\theta_{JA} = 130^{\circ}C/W</math></p>	<p>TOP VIEW  <math>V_{OS}</math> TRIM  <math>V_{OS}</math> TRIM  <math>V^+</math>  <math>V^-</math>          S8 PACKAGE          8-LEAD PLASTIC SO  <math>T_{JMAX} = 150^{\circ}C</math>, <math>\theta_{JA} = 190^{\circ}C/W</math></p>
<p>ORDER PART NUMBER</p>	<p>ORDER PART NUMBER</p>	<p>ORDER PART NUMBER</p>	<p>S8 PART MARKING</p>
<p>LT1077AMH              LT1077MH              LT1077ACH              LT1077CH</p>	<p>LT1077AMJ8              LT1077MJ8              LT1077ACJ8              LT1077CJ8</p>	<p>LT1077S8              LT1077IS8              LT1077AIN8              LT1077IN8              LT1077ACN8              LT1077CN8</p>	<p>1077              1077I</p>
<p><b>OBSOLETE PACKAGE</b></p>			
<p>Consider the N8 or S8 Package for Alternate Source</p>			

Consult LTC Marketing for parts specified with wider operating temperature ranges.

**ELECTRICAL CHARACTERISTICS**

$V_S = 5V, 0V, V_{CM} = 0.1V, V_O = 1.4V, T_A = 25^{\circ}C$  unless noted.

SYMBOL	PARAMETER	CONDITIONS	LT1077AM/AI/AC			LT1077M/I/C/S8			UNITS
			MIN	TYP	MAX	MIN	TYP	MAX	
$V_{OS}$	Input Offset Voltage	LT1077S8		9	40		10	60	$\mu V$ $\mu V$
$\frac{\Delta V_{OS}}{\Delta Time}$	Long Term Input Offset Voltage Stability			0.4			0.4		$\mu V/Mo$
$I_{OS}$	Input Offset Current			0.06	0.35		0.06	0.45	nA
$I_B$	Input Bias Current			7	9		7	11	nA
$e_n$	Input Noise Voltage	0.1Hz to 10Hz (Note3)		0.5	1.1		0.5		$\mu V_{p-p}$
	Input Noise Voltage Density	$f_0 = 10Hz$ (Note 3) $f_0 = 1000Hz$ (Note3)		28	43		28	27	nV/ $\sqrt{Hz}$ nV/ $\sqrt{Hz}$
$i_n$	Input Noise Current	0.1Hz to 10Hz (Note3)		2.5	4.5		2.5		pA $_{p-p}$

**ELECTRICAL CHARACTERISTICS**  $V_S = 5V, 0V, V_{CM} = 0.1V, V_O = 1.4V, T_A = 25^\circ C$  unless noted.

SYMBOL	PARAMETER	CONDITIONS	LT1077AM/AI/AC			LT1077M/I/C/S8			UNITS	
			MIN	TYP	MAX	MIN	TYP	MAX		
	Input Noise Current Density	$f_0 = 10\text{Hz}$ (Note 3) $f_0 = 1000\text{Hz}$		0.065 0.02	0.11		0.065 0.02		$\text{pA}/\sqrt{\text{Hz}}$ $\text{pA}/\sqrt{\text{Hz}}$	
	Input Resistance Differential Mode Common Mode	(Note 4)	350	700 6		270	700 6		$\text{M}\Omega$ $\text{G}\Omega$	
	Input Voltage Range		3.5 0	3.8 -0.3		3.5 0	3.8 -0.3		V V	
CMRR	Common Mode Rejection Ratio	$V_{CM} = 0V$ to 3.5V	97	106		94	105		dB	
PSRR	Power Supply Rejection Ratio	$V_S = 2.3V$ to 12V	102	118		100	117		dB	
$A_{VOL}$	Large-Signal Voltage Gain	$V_O = 0.03V$ to 4V, No Load $V_O = 0.03V$ to 3.5V, $R_L = 50k$	300 250	1000 1000		240 200	1000 1000		V/mV V/mV	
	Maximum Output Voltage Swing	Output Low, No Load		3.5	6		3.5	6	mV	
		Output Low, 2k to GND		0.7	1.1		0.7	1.1	mV	
		Output Low, $I_{SINK} = 100\mu A$			90	130		90	130	mV
		Output High, No Load		4.2	4.4		4.2	4.4	V	
		Output High, 2k to GND		3.5	3.9		3.5	3.9	V	
SR	Slew Rate	(Note 2)	0.05	0.08		0.05	0.08		V/ $\mu s$	
GBW	Gain Bandwidth Product	$f_0 \leq 20\text{kHz}$		230			230		kHz	
$I_S$	Supply Current			48	60		48	68	$\mu A$	
	Offset Adjustment Range	$R_{pot} = 10k$ , Wiper to $V^+$	$\pm 500$	$\pm 900$		$\pm 500$	$\pm 900$		$\mu V$	
	Minimum Supply Voltage	(Note 5)		2.2	2.3		2.2	2.3	V	

The ● denotes the specifications which apply over the temperature range of  $-55^\circ C \leq T_A \leq 125^\circ C$  for AM/M grades,  $-40^\circ C \leq T_A \leq 85^\circ C$  for AI/I grades.  $V_S = 5V, 0V, V_{CM} = 0.1V, V_O = 1.4V$  unless otherwise noted.

SYMBOL	PARAMETER	CONDITIONS		LT1077AM/AI			LT1077M/I			UNITS
				MIN	TYP	MAX	MIN	TYP	MAX	
$V_{OS}$	Input Offset Voltage		●		50	200		60	260	$\mu V$
$\Delta V_{OS}/\Delta T$	Input Offset Voltage Drift	LT1077IS8 (Note 6)	●					1	2.5	$\mu V/^\circ C$
$I_{OS}$	Input Offset Current		●		0.08	0.60		0.08	0.80	nA
$I_B$	Input Bias Current		●		8	11		8	13	nA
CMRR	Common Mode Rejection Ratio	$V_{CM} = 0.05V$ to 3.2V	●	92	104		88	103		dB
PSRR	Power Supply Rejection Ratio	$V_S = 3.1V$ to 12V	●	98	114		94	113		dB
$A_{VOL}$	Large-Signal Voltage Gain	$V_O = 0.05V$ to 3.5V, $R_L = 50k$	●	120	600		100	600		V/mV
	Maximum Output Voltage Swing	Output Low, No Load	●		4.5	8		4.5	8	mV
		Output Low, $I_{SINK} = 100\mu A$	●		120	170		120	170	mV
		Output High, No Load	●	3.9	4.2		3.9	4.2		V
		Output High, 2k to GND	●	3	3.7		3	3.7		V
$I_S$	Supply Current		●		54	80		54	90	$\mu A$

**ELECTRICAL CHARACTERISTICS** The ● denotes the specifications which apply over the temperature range of 0°C ≤ T<sub>A</sub> ≤ 70°C otherwise, specifications are at T<sub>A</sub> = 25°C. V<sub>S</sub> = 5V, 0V, V<sub>CM</sub> = 0.1V, V<sub>O</sub> = 1.4V unless noted.

SYMBOL	PARAMETER	CONDITIONS	LT1077AC			LT1077C/S8			UNITS	
			MIN	TYP	MAX	MIN	TYP	MAX		
V <sub>OS</sub>	Input Offset Voltage	LT1077S8	●	30	110	●	35	150	μV	
			●			●	40	280	μV	
ΔV <sub>OS</sub> /ΔT	Input Offset Voltage Drift	(Note 6) LT1077S8 (Note 6)	●	0.4	1.6	●	0.5	2.0	μV/°C	
			●			●	0.7	3.0	μV/°C	
I <sub>OS</sub>	Input Offset Current		●	0.07	0.45	●	0.07	0.60	nA	
I <sub>B</sub>	Input Bias Current		●	7	10	●	7	12	nA	
CMRR	Common Mode Rejection Ratio	V <sub>CM</sub> = 0V to 3.4V	●	94	105	●	90	104	dB	
PSRR	Power Supply Rejection Ratio	V <sub>S</sub> = 2.6V to 12V	●	100	116	●	97	115	dB	
A <sub>VOL</sub>	Large-Signal Voltage Gain	V <sub>O</sub> = 0.05V to 3.5V, R <sub>L</sub> = 50k	●	180	800	●	150	800	V/mV	
	Maximum Output Voltage Swing	Output Low, No Load	●		4.0	7	●	4.0	7	mV
		Output Low, I <sub>SINK</sub> = 100μA	●		100	150	●	100	150	mV
		Output High, No Load	●	4.1	4.3	●	4.1	4.3	V	
		Output High, 2k to GND	●	3.3	3.8	●	3.3	3.8	V	
I <sub>S</sub>	Supply Current		●	52	70	●	52	80	μA	

V<sub>S</sub> = ±15V, T<sub>A</sub> = 25°C unless noted.

SYMBOL	PARAMETER	CONDITIONS	LT1077AM/AI/AC			LT1077M/I/C/S8			UNITS
			MIN	TYP	MAX	MIN	TYP	MAX	
V <sub>OS</sub>	Input Offset Voltage	LT1077S8		20	150		25	200	μV
							30	300	μV
I <sub>OS</sub>	Input Offset Current			0.06	0.35		0.06	0.45	nA
I <sub>B</sub>	Input Bias Current			7	9		7	11	nA
	Input Voltage Range		13.5	13.8		13.5	13.8		V
				-15.0	-15.3		-15.0	-15.3	
CMRR	Common Mode Rejection Ratio	V <sub>CM</sub> = 13.5V to -15V		100	109		97	108	dB
PSRR	Power Supply Rejection Ratio	V <sub>S</sub> = 5V, 0V to ±18V		106	122		103	120	dB
A <sub>VOL</sub>	Large-Signal Voltage Gain	V <sub>O</sub> = ±10V, R <sub>L</sub> = 50k		1000	8000		800	8000	V/mV
		V <sub>O</sub> = ±10V, R <sub>L</sub> = 2k		400	1500		300	1500	V/mV
V <sub>OUT</sub>	Maximum Output Voltage Swing	R <sub>L</sub> = 50k		±13.0	±14.0		±13.0	±14.0	V
		R <sub>L</sub> = 2k		±11.0	±13.2		±11.0	±13.2	V
SR	Slew Rate			0.07	0.12		0.07	0.12	V/μs
I <sub>S</sub>	Supply Current			56	75		56	85	μA

**ELECTRICAL CHARACTERISTICS** The ● denotes the specifications which apply over the temperature range of  $-55^{\circ}\text{C} \leq T_A \leq 125^{\circ}\text{C}$  for AM/M grades,  $-40^{\circ}\text{C} \leq T_A \leq 85^{\circ}\text{C}$  for AI/I grades.  $V_S = \pm 15\text{V}$  unless otherwise noted.

SYMBOL	PARAMETER	CONDITIONS	LT1077AM/AI			LT1077M/I			UNITS
			MIN	TYP	MAX	MIN	TYP	MAX	
$V_{OS}$	Input Offset Voltage		●	60	330		75	450	$\mu\text{V}$
$\Delta V_{OS}/\Delta T$	Input Offset Voltage Drift	LT1077IS8 (Note 6)	●				1.1	3	$\mu\text{V}/^{\circ}\text{C}$
$I_{OS}$	Input Offset Current		●	0.08	0.60		0.08	0.80	nA
$I_B$	Input Bias Current		●	8	11		8	13	nA
$A_{VOL}$	Large-Signal Voltage Gain	$V_O = \pm 10\text{V}$ , $R_L = 5\text{k}$	●	300	1000		250	1000	V/mV
CMRR	Common Mode Rejection Ratio	$V_{CM} = 13\text{V}$ , $-14.9\text{V}$	●	94	107		90	106	dB
PSRR	Power Supply Rejection Ratio	$V_S = 5\text{V}$ , $0\text{V}$ to $\pm 18\text{V}$	●	100	118		97	116	dB
	Maximum Output Voltage Swing	$R_L = 5\text{k}$	●	$\pm 11$	$\pm 13.5$		$\pm 11$	$\pm 13.5$	V
$I_S$	Supply Current		●	60	95		60	105	$\mu\text{A}$

The ● denotes the specifications which apply over the temperature range of  $0^{\circ}\text{C} \leq T_A \leq 70^{\circ}\text{C}$ .  $V_S = \pm 15\text{V}$  unless otherwise noted.

SYMBOL	PARAMETER	CONDITIONS	LT1077AC			LT1077C/S8			UNITS
			MIN	TYP	MAX	MIN	TYP	MAX	
$V_{OS}$	Input Offset Voltage	LT1077S8	●	40	230		50	320	$\mu\text{V}$
			●				65	450	$\mu\text{V}$
$\Delta V_{OS}/\Delta T$	Input Offset Voltage Drift	(Note 6)	●	0.4	1.8		0.5	2.5	$\mu\text{V}/^{\circ}\text{C}$
		LT1077S8 (Note 6)	●				0.8	3.5	$\mu\text{V}/^{\circ}\text{C}$
$I_{OS}$	Input Offset Current		●	0.07	0.45		0.07	0.60	nA
$I_B$	Input Bias Current		●	7	10		7	12	nA
$A_{VOL}$	Large-Signal Voltage Gain	$V_O = \pm 10\text{V}$ , $R_L = 5\text{k}$	●	500	2000		400	2000	V/mV
CMRR	Common Mode Rejection Ratio	$V_{CM} = 13\text{V}$ , $-15\text{V}$	●	97	108		94	107	dB
PSRR	Power Supply Rejection Ratio	$V_S = 5\text{V}$ , $0\text{V}$ to $\pm 18\text{V}$	●	103	120		100	118	dB
	Maximum Output Voltage Swing	$R_L = 5\text{k}$	●	$\pm 11$	$\pm 13.6$		$\pm 11$	$\pm 13.6$	V
$I_S$	Supply Current		●	59	85		59	95	$\mu\text{A}$

**Note 1:** Absolute Maximum Ratings are those values beyond which the life of a device may be impaired.

**Note 2:** Slew rate at 5V, 0V is guaranteed by inference from the slew rate measurement at  $\pm 15\text{V}$ .

**Note 3:** This parameter is tested on a sample basis only. All noise parameters are tested with  $V_S = \pm 2.5\text{V}$ ,  $V_O = 0\text{V}$ .

**Note 4:** This parameter is guaranteed by design and is not tested.

**Note 5:** Power supply rejection ratio is measured at the minimum supply voltage. The op amps actually work at 1.8V supply but with a typical offset skew of  $-300\mu\text{V}$ .

**Note 6:** This parameter is not 100% tested.

# TYPICAL PERFORMANCE CHARACTERISTICS

Supply Current vs Temperature

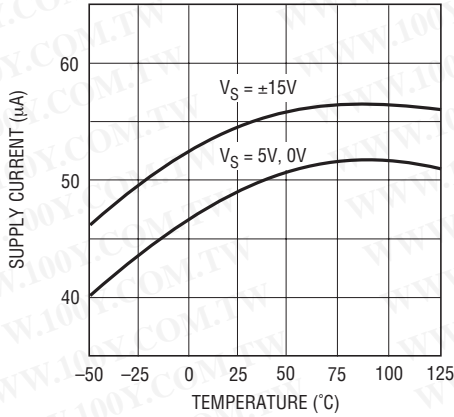

LT1077 • TPC01

Input Bias and Offset Currents vs Temperature

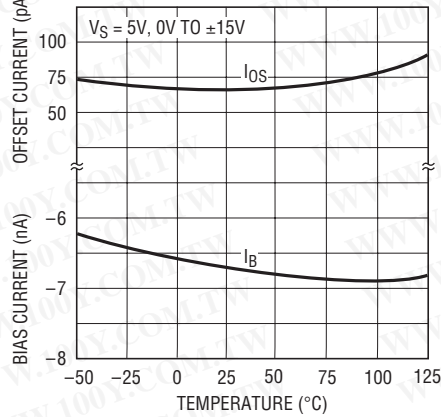

LT1077 • TPC02

Input Bias Currents vs Common Mode Voltage

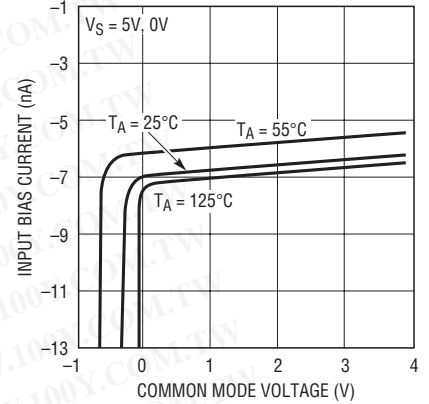

LT1077 • TPC03

0.1Hz to 10Hz Noise

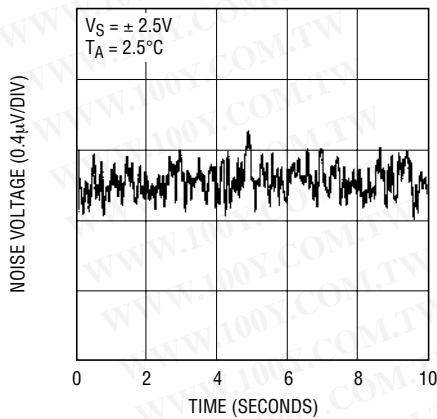

LT1077 • TPC04

0.01Hz to 10Hz Noise

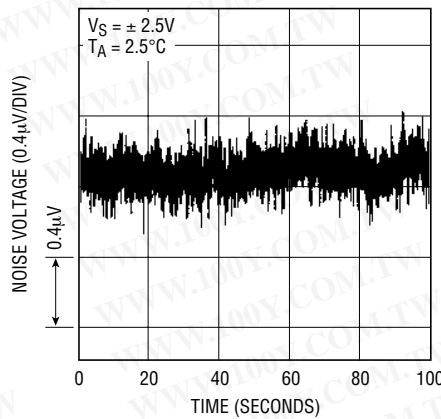

LT1077 • TPC05

Noise Spectrum

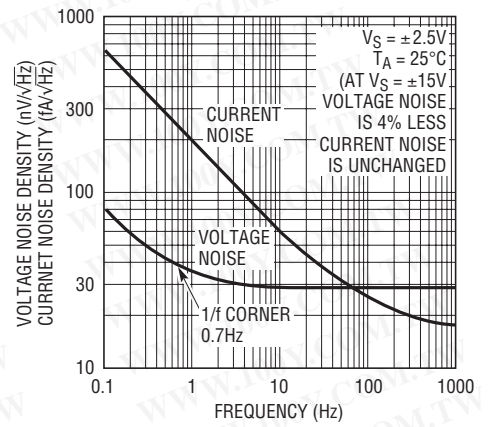

LT1077 • TPC06

10Hz Voltage Noise Distribution

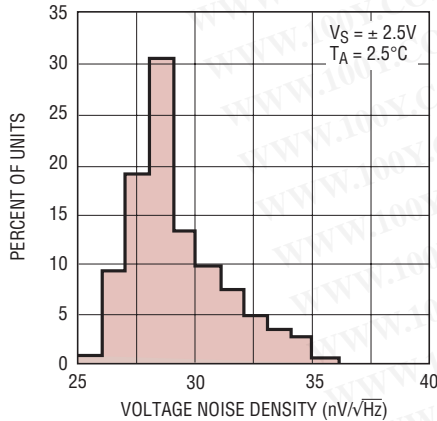

LT1077 • TPC07

Distribution of Offset Voltage Drift with Temperature (In All Packages)

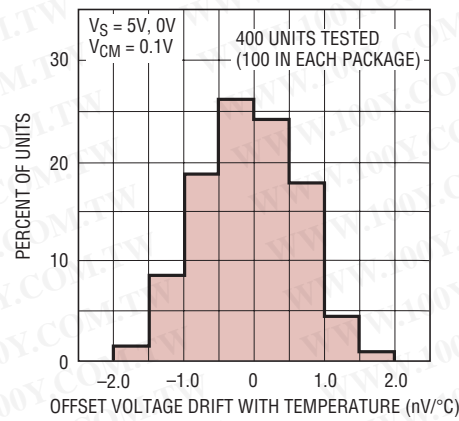

LT1077 • TPC08

Distribution of Input Offset Voltage in Small Outline (S8) Package

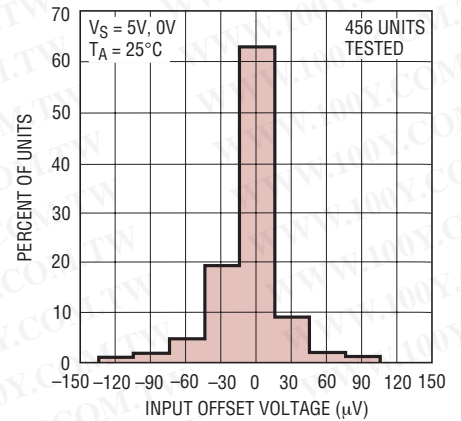

LT1077 • TPC09

# TYPICAL PERFORMANCE CHARACTERISTICS

**Voltage Gain vs Frequency**

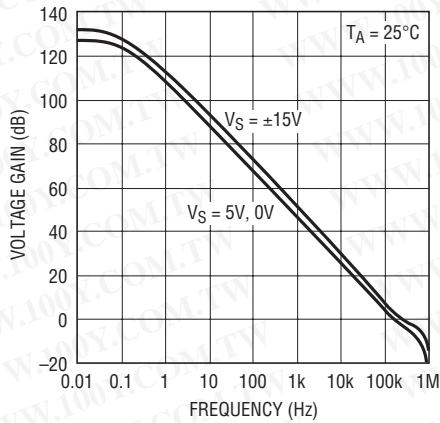

LT1077 • TPC10

**Gain, Phase vs Frequency**

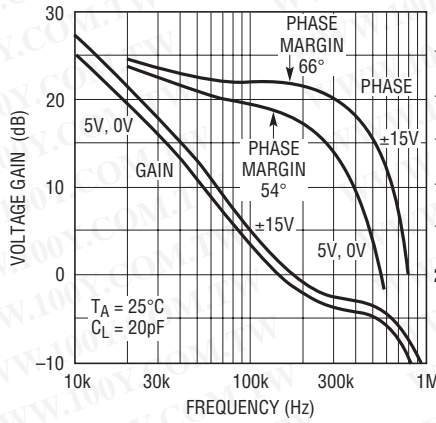

LT1077 • TPC11

**Capacitive Load Handling**

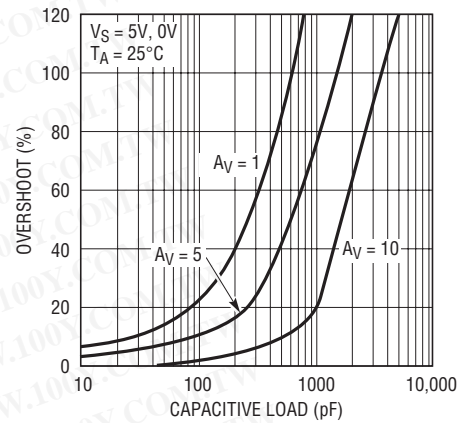

LT1077 • TPC12

**Slew Rate, Gain Bandwidth Product and Phase Margin vs Temperature**

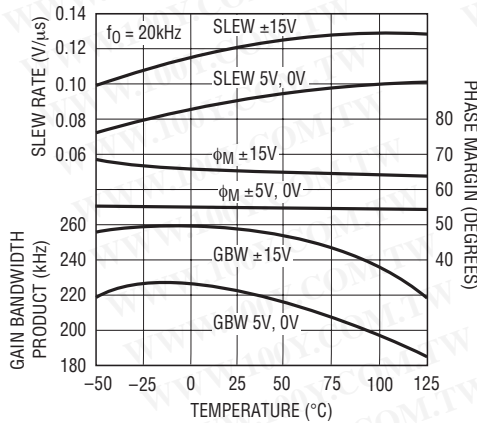

LT1077 • TPC13

**Large-Signal Transient Response VS = 5V, 0V**

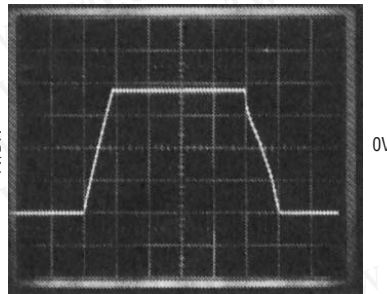

AV = 1  
NO LOAD  
INPUT PULSE 0V TO 3.8V

**Large-Signal Transient Response VS = ±15V**

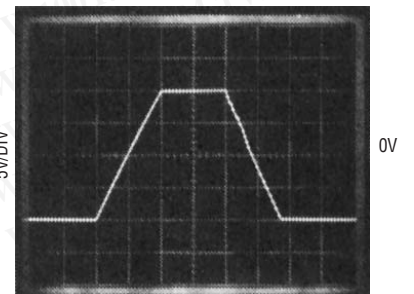

AV = 1  
NO LOAD

**Small-Signal Transient Response VS = 5V, 0V**

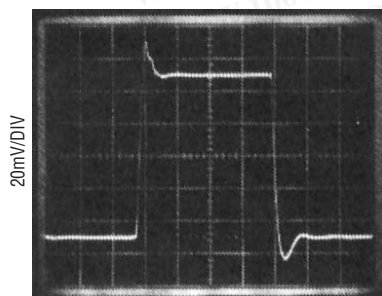

AV = 1  
CL = 15pF  
INPUT 50mV TO 150mV

**Small-Signal Transient Response VS = ± 2.5V**

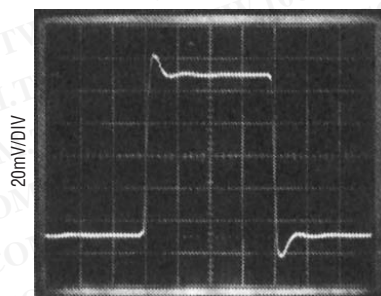

AV = 1  
CL = 15pF

**Small-Signal Transient Response VS = ±15V**

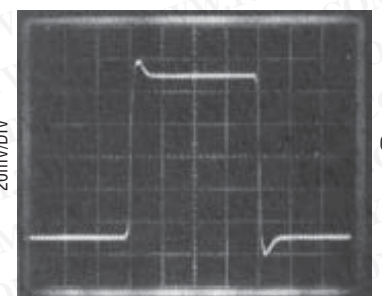

AV = 1  
CL = 15pF

# TYPICAL PERFORMANCE CHARACTERISTICS

**Minimum Supply Voltage**

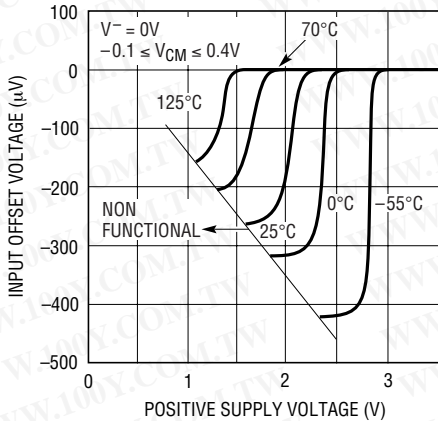

LT1077 • TPC19

**Warm-Up Drift**

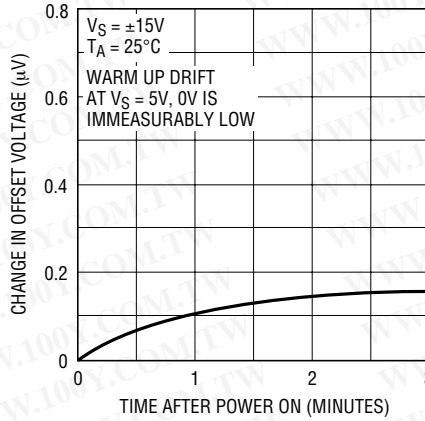

LT1077 • TPC20

**Voltage Gain vs Load Resistance**

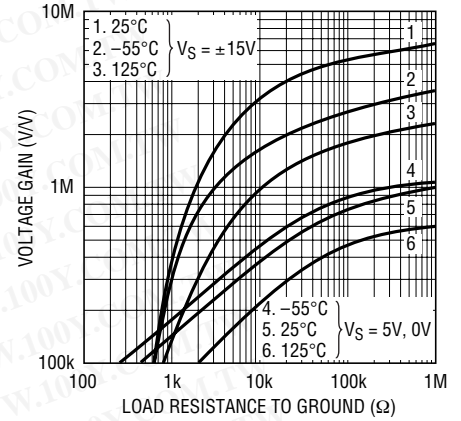

LT1077 • TPC21

**Output Saturation vs Temperature vs Sink Current**

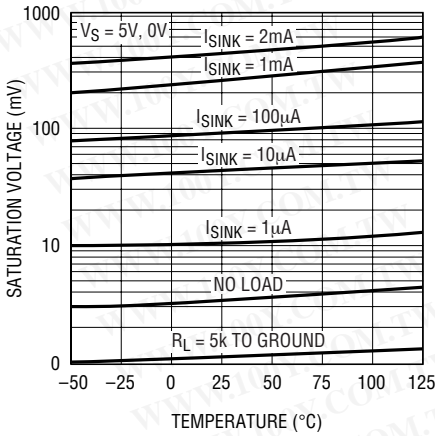

LT1077 • TPC22

**Output Voltage Swing vs Load Current**

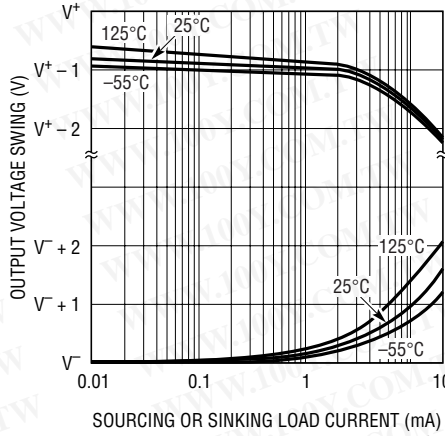

LT1077 • TPC23

**Short-Circuit Current vs Time**

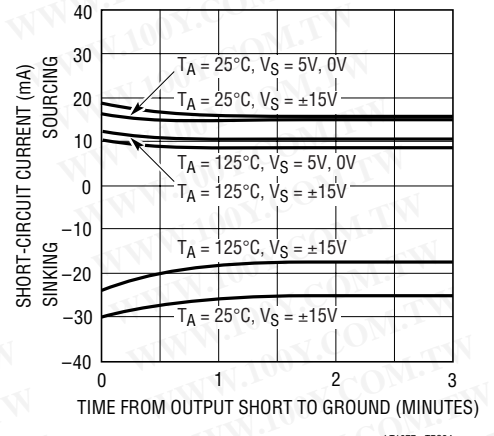

LT1077 • TPC24

**Common Mode Range vs Temperature**

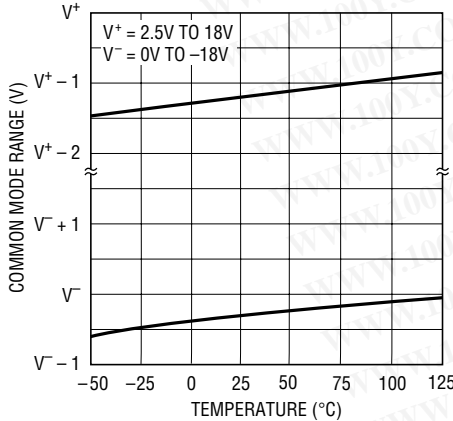

LT1077 • TPC25

**Undistorted Output Swing vs Frequency**

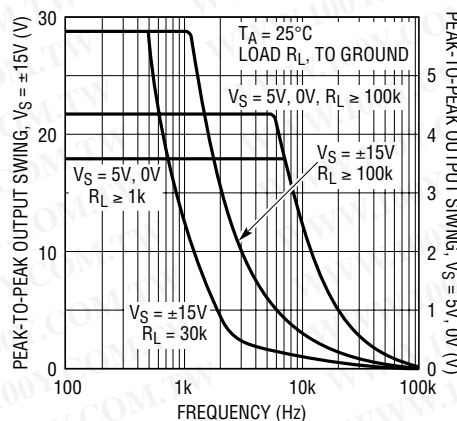

LT1077 • TPC26

**Closed Loop Output Impedance**

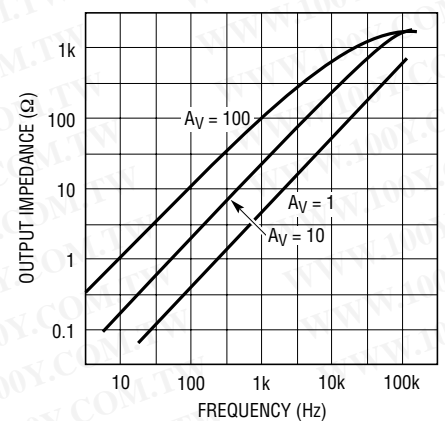

LT1077 • TPC27



## TYPICAL PERFORMANCE CHARACTERISTICS

**Common Mode Rejection Ratio vs Frequency**

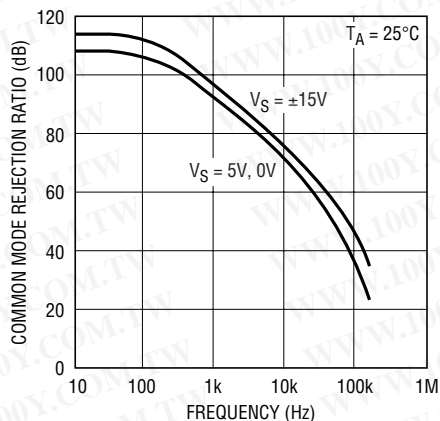

LT1077 • TPC28

**Power Supply Rejection Ratio vs Frequency**

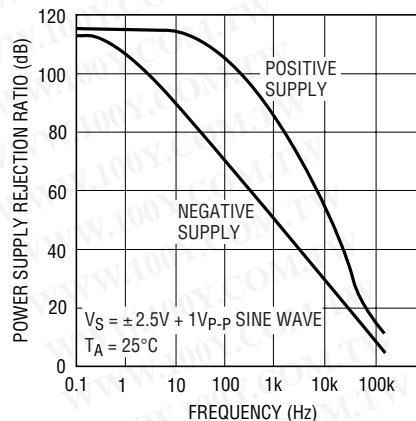

LT1077 • TPC29

## APPLICATIONS INFORMATION

The LT1077 is fully specified with  $V^+ = 5V$ ,  $V^- = 0V$ ,  $V_{CM} = 0.1V$ . This set of operating conditions appears to be the most representative for battery powered micropower circuits. Offset voltage is internally trimmed to a minimum value at these supply voltages. When 9V or 3V batteries, or  $\pm 2.5V$  dual supplies are used, bias and offset current changes will be minimal. Offset voltage changes will be just a few microvolts as given by the PSRR and CMRR specifications. For example, if  $PSRR = 114dB (= 2\mu V/V)$ , at 9V the offset voltage change will be  $8\mu V$ . Similarly,  $V_S \pm 2.5V$ ,  $V_{CM} = 0$  is equivalent to a common mode voltage change of 2.4V or a  $V_{OS}$  change of  $7\mu V$  if  $CMRR = 110dB (3\mu V/V)$ .

A full set of specifications is also provided at  $\pm 15V$  supply voltages for comparison with other devices and for completeness.

The LT1077 is pin compatible to, and directly replaces, such precision op amps as the OP-07, OP-77, AD707 and LT1001 with 30 to 60 times savings in supply current. The LT1077 is also a direct plug-in replacement for LT1012 and OP-97 devices with 10 times lower dissipation. Compatibility includes externally nulling the offset voltage, as all of the devices above are trimmed with a potentiometer between Pins 1 and 8 and the wiper tied to  $V^+$ .

The LT1077 replaces and upgrades such micropower op amps as the OP-20, LM4250, and OP-90, provided that the external nulling circuitry (and set resistor in the case of the LM4250) are removed. Since the offset voltage of the LT1077 is extremely low, nulling will be unnecessary in most applications.

### Single Supply Operation

The LT1077 is fully specified for single supply operation, (i.e., when the negative supply is 0V). Input common mode range goes below ground and the output swings within a few millivolts of ground while sinking current. All competing micropower op amps either cannot swing to within 600mV of ground (OP-20, OP-220, OP-420) or need a pull-down resistor connected to the output to swing to ground (OP-90, OP-290, OP-490, HA5141/42/44). This difference is critical because in many applications these competing devices cannot be operated as micropower op amps and swing to ground simultaneously.

Consider the difference amplifiers shown in Typical Applications as an example. When the common mode signal is high and the output low, the amplifier has to sink current. In the gain of 10 circuit, the competing devices require a 30k pull-down resistor at the output to handle the specified signals. (The LT1077 does not need pull-down

## APPLICATIONS INFORMATION

resistors.) When the output is high the pull-down resistor draws 80 $\mu$ A which dominates the micropower current budget. This situation is much worse in the gain of one circuit with  $V^- = 0V$ . At 100V common mode, the output has to sink 2 $\mu$ A. At a minimum output voltage of 20mV competing devices require a 10k pull-down resistor. As the output now swings to 10V, this resistor draws 1mA of current.

Since the output of the LT1077 cannot go exactly to ground, but can only approach ground to within a few millivolts, care should be exercised to ensure that the output is not saturated. For example, a 1mV input signal will cause the amplifier to set up in its linear region in the gain 100 configuration shown below; however, it is not enough to make the amplifier function properly in the voltage follower mode.

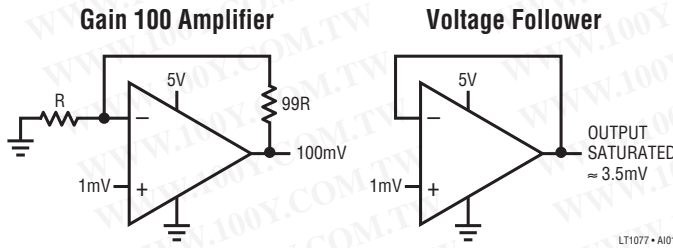

Single supply operation can also create difficulties at the input. The driving signal can fall below 0V—inadvertently or on a transient basis. If the input is more than a few hundred millivolts below ground, two distinct problems can occur on previous single supply designs, such as the LM124, LM158, OP-20, OP-21, OP-220, OP-221, OP-420 (a and b), OP-90/290/490 (b only):

a) When the input is more than a diode drop below ground, unlimited current will flow from the substrate ( $V^-$  terminal) to the input (this can destroy the unit). On the LT1077, resistors in series with the input protect the device even when the input is 5V below ground.

b) When the input is more than 400mV below ground (at 25°C), the input stage saturates and phase reversal occurs at the output (this can cause lock-up in servo systems). Due to a unique phase reversal protection circuitry, the LT1077's output does not reverse, as illustrated below, even when the input is at -1.0V.

Voltage Follower with Input Exceeding the Negative Common Mode Range ( $V_S = 5V, 0V$ )

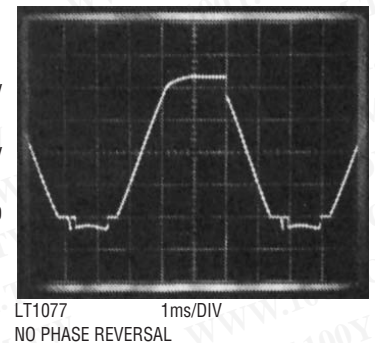
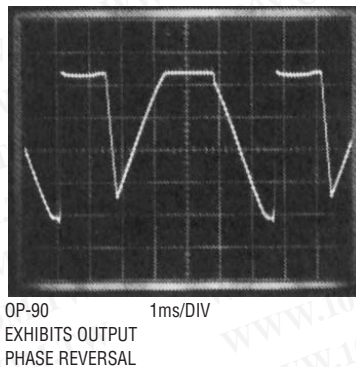
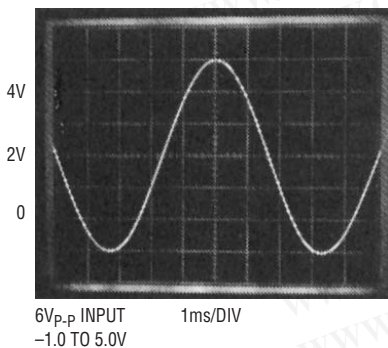

# APPLICATIONS INFORMATION

## Comparator Applications

The single supply operation of the LT1077 and its ability to swing close to ground while sinking current,

lends itself to use as a precision comparator with TTL compatible output.

**Comparator Rise Response Time to 10mV, 5mV, 2mV Overdrive**

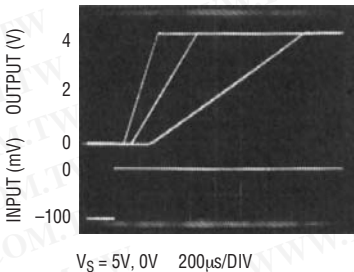

**Comparator Fall Response Time to 10mV, 5mV, 2mV Overdrive**

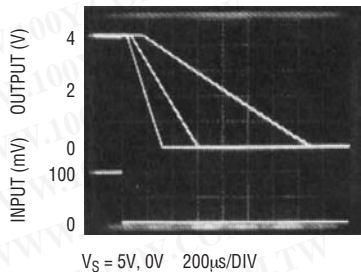

# TYPICAL APPLICATIONS

**Megaohm Input Impedance Gain of 10 Difference Amplifier**

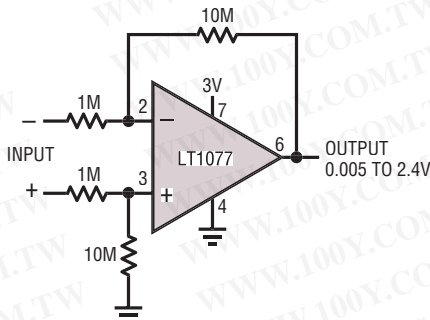

- BANDWIDTH = 20KHZ
- OUTPUT OFFSET = 0.7mV
- OUTPUT NOISE = 80µVPP (0.1Hz TO 10Hz)
- 260µV<sub>RMS</sub> OVER FULL BANDWIDTH
- SUPPLY CURRENT = 45µA

THE USEFULNESS OF DIFFERENCE AMPLIFIERS IS LIMITED BY THE FACT THAT THE INPUT RESISTANCE IS EQUAL TO THE SOURCE RESISTANCE. THE PICO-AMPERE OFFSET CURRENT AND LOW CURRENT NOISE OF THE LT1077 ALLOWS THE USE OF 1M SOURCE RESISTORS WITHOUT DEGRADATION IN PERFORMANCE. IN ADDITION, WITH MEGAOHM RESISTORS MICROPPOWER OPERATION CAN BE MAINTAINED

LT1077-1A03

TYPICAL APPLICATIONS

±250V Common Mode Range Difference Amplifier ( $A_V = 1$ )

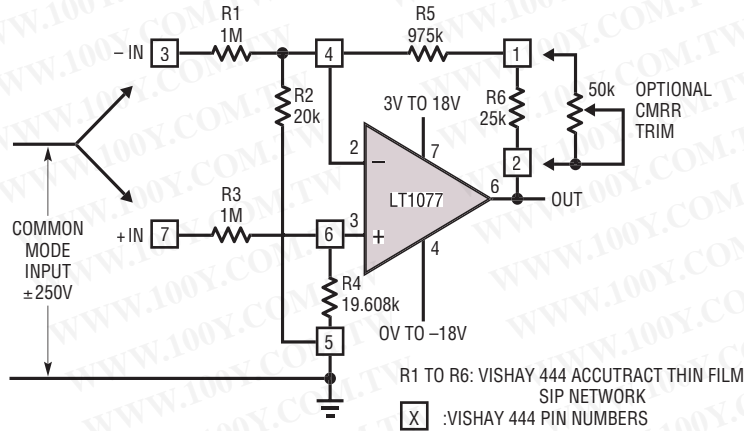

VISHAY INTERTECHNOLOGY, INC.  
 63 LINCOLN HIGHWAY  
 MALVERN, PA 19355

- COMMON MODE REJECTION RATIO = 74dB (RESISTOR LIMITED)
- WITH OPTIONAL TRIM = 108dB
- OUTPUT OFFSET (TRIMMABLE TO ZERO) = 500µV
- OUTPUT OFFSET DRIFT = 25µV/°C
- INPUT RESISTANCE = 1M
- COMMON MODE RANGE = ±250V,  $V^+ = 6.2V$  TO 18V,  $V^- = -4.7V$  TO -18V
- = ±100V,  $V^+ \geq 3.2V$ ,  $V^- \leq -1.8V$
- = 100V, -13V,  $V^+ \geq 3.2V$ ,  $V^- = 0V$

LT1077 • TA04

Two Terminal Current Source

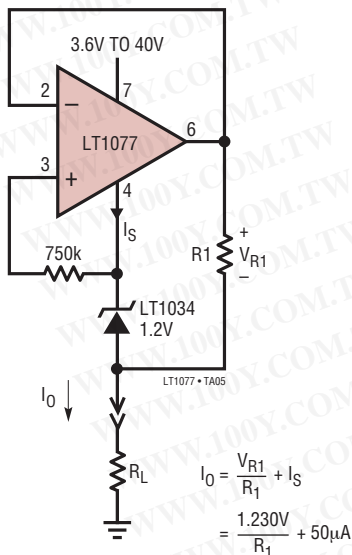

MINIMUM CURRENT = 50µA ( $R_1 \rightarrow \infty$ )  
 MAXIMUM CURRENT = 10.3mA ( $R_1 = 120\Omega$ )

Half-Wave Rectifier

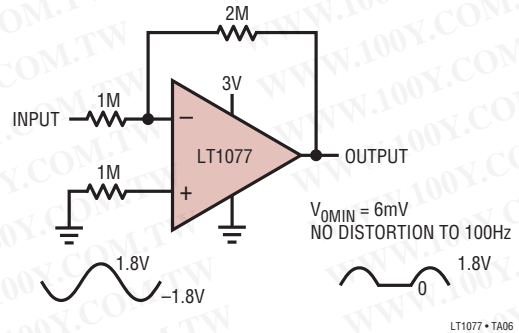

LT1077 • TA06

# SIMPLIFIED SCHEMATIC

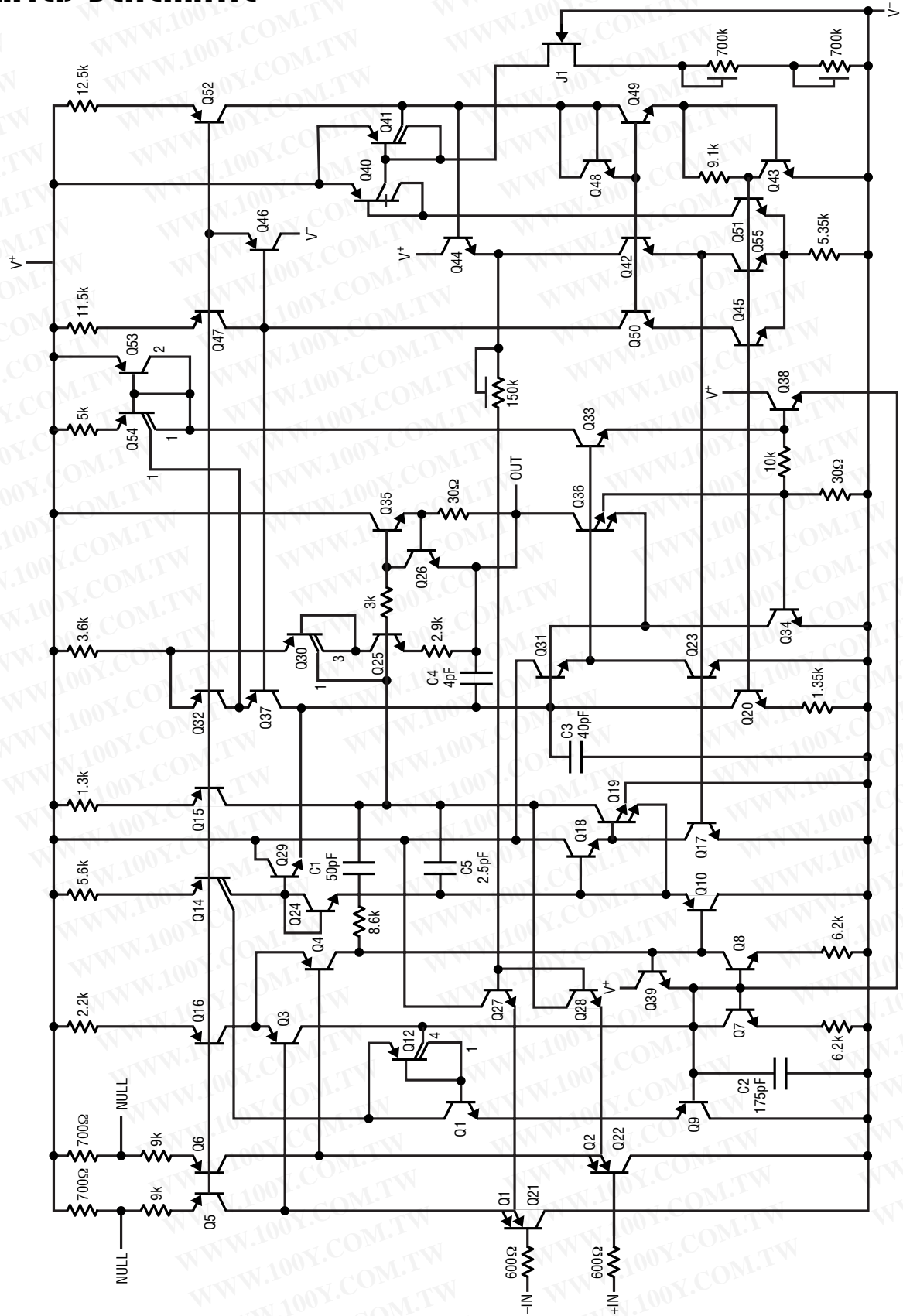

LT1077-S01



**PACKAGE DESCRIPTION**

**N8 Package**  
**8-Lead PDIP (Narrow .300 Inch)**  
 (Reference LTC DWG # 05-08-1510)

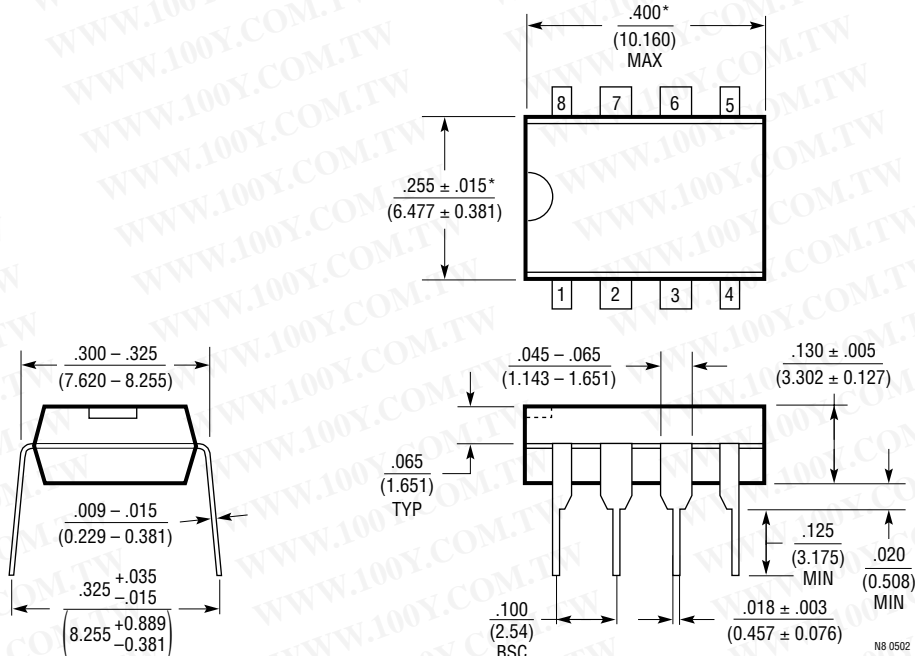

NOTE:  
 1. DIMENSIONS ARE  $\frac{\text{INCHES}}{\text{MILLIMETERS}}$   
 \*THESE DIMENSIONS DO NOT INCLUDE MOLD FLASH OR PROTRUSIONS.  
 MOLD FLASH OR PROTRUSIONS SHALL NOT EXCEED .010 INCH (0.254mm)

**PACKAGE DESCRIPTION**

勝特力材料 886-3-5753170  
 勝特力电子(上海) 86-21-34970699  
 勝特力电子(深圳) 86-755-83298787  
 Http://www.100y.com.tw

**S8 Package**  
**8-Lead Plastic Small Outline (Narrow .150 Inch)**  
 (Reference LTC DWG # 05-08-1610)

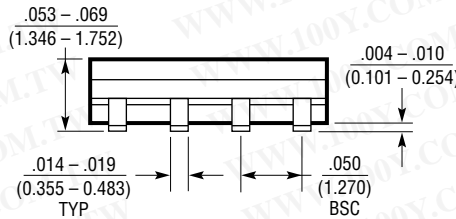
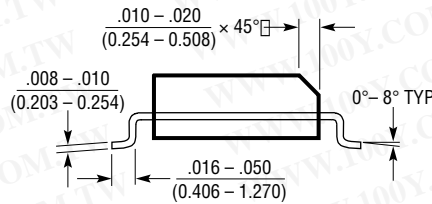
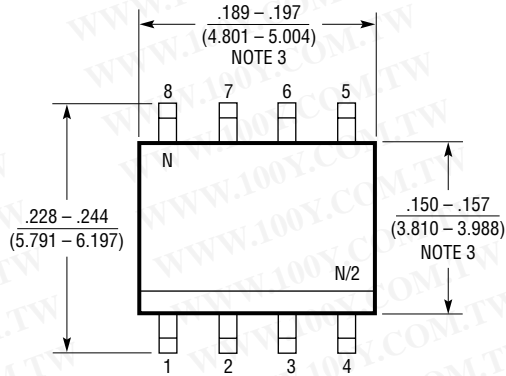
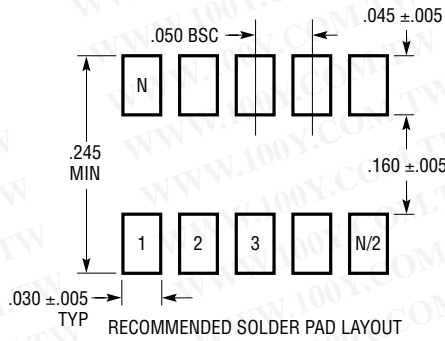

- NOTE:  
 1. DIMENSIONS IN INCHES (MILLIMETERS)  
 2. DRAWING NOT TO SCALE  
 3. THESE DIMENSIONS DO NOT INCLUDE MOLD FLASH OR PROTRUSIONS. MOLD FLASH OR PROTRUSIONS SHALL NOT EXCEED .006" (0.15mm)

S08 0502