

General-purpose Operational Amplifier / Comparator

Ground Sense Comparator

勝特力材料 886-3-5753170
 勝特力电子(上海) 86-21-34970699
 勝特力电子(深圳) 86-755-83298787
[Http://www.100y.com.tw](http://www.100y.com.tw)



BA10393F, BA10339F/FV, BA2903F/FV/FVM, BA2901F/FV/KN

● Description

General purpose BA10393/BA10339 family and high reliability BA2903/BA2901 family integrate two or four independent high gain voltage comparator. Some features are the wide operating voltage that is 2 to 36[V](for BA10393, BA2903, BA2901 family) 3 to 36[V](for BA10339family) and low supply current. Therefore, these IC are suitable for any application.

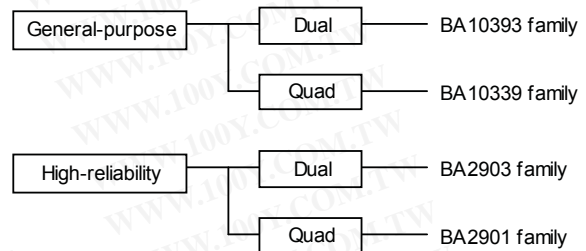

● Features

- | | | | | | | | | | | |
|---|---|----------------------|-------------------------------------|---------------------------------------|----------------------|-------------------------------------|---------------------------------------|----------------------------|-------------------------------------|---|
| 1) Operable with a single power supply | 3) Standard comparator pin-assignments | | | | | | | | | |
| 2) Wide Operating supply voltage | 4) Input and output are operable nearly GND level | | | | | | | | | |
| <table border="0"> <tr> <td>[+2.0[V] to +36.0[V] (single supply)</td> <td rowspan="2">] (BA10393 family)</td> </tr> <tr> <td>[±1.0[V] to±18.0[V] (split supply)</td> </tr> <tr> <td>[+3.0[V] to +36.0[V] (single supply)</td> <td rowspan="2">] (BA10339 family)</td> </tr> <tr> <td>[±1.5[V] to±18.0[V] (split supply)</td> </tr> <tr> <td>[+2.0[V] to +36.0[V] (single supply)</td> <td rowspan="2">] (BA2903/BA2901 family)</td> </tr> <tr> <td>[±1.0[V] to±18.0[V] (split supply)</td> </tr> </table> | [+2.0[V] to +36.0[V] (single supply) |] (BA10393 family) | [±1.0[V] to±18.0[V] (split supply) | [+3.0[V] to +36.0[V] (single supply) |] (BA10339 family) | [±1.5[V] to±18.0[V] (split supply) | [+2.0[V] to +36.0[V] (single supply) |] (BA2903/BA2901 family) | [±1.0[V] to±18.0[V] (split supply) | 5) Internal ESD protection.
Human body model (HBM) ±5000[V] (Typ.)
(BA2903/BA2901 family) |
| [+2.0[V] to +36.0[V] (single supply) |] (BA10393 family) | | | | | | | | | |
| [±1.0[V] to±18.0[V] (split supply) | | | | | | | | | | |
| [+3.0[V] to +36.0[V] (single supply) |] (BA10339 family) | | | | | | | | | |
| [±1.5[V] to±18.0[V] (split supply) | | | | | | | | | | |
| [+2.0[V] to +36.0[V] (single supply) |] (BA2903/BA2901 family) | | | | | | | | | |
| [±1.0[V] to±18.0[V] (split supply) | | | | | | | | | | |
| | 9) Gold PAD (BA2903/BA2901 family) | | | | | | | | | |
| | 10) Wide temperature range
-40[°C] to +125[°C](BA2903/BA2901 family)
-40[°C] to +85[°C](BA10393/BA10339 family) | | | | | | | | | |

● Pin Assignments

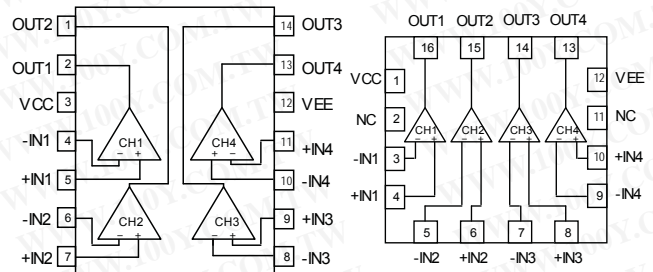
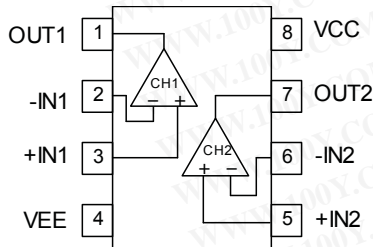

SOP8

SSOP-B8

MSOP8

SOP14

SSOP-B14

VQFN16

BA10393F
BA2903F

BA2903FV

BA2903FVM

BA10339F
BA2901F

BA10339FV
BA2901FV

BA2901KN

● Absolute maximum ratings (Ta=25[°C])

Parameter	Symbol	Rating				Unit
		BA10393 family	BA10339 family	BA2903 family	BA2901 family	
Supply Voltage	VCC-VEE	+36				V
Differential Input Voltage(*1)	Vid	VCC – VEE		36		V
Input Common-mode voltage range	Vicm	VEE to VCC		(VEE-0.3) to VEE+36		V
Operating Temperature	Topr	-40 to +85		-40 to +125		°C
Storage Temperature	Tstg	-55 to +125		-55 to +150		°C
Maximum junction Temperature	Tjmax	+125		+150		°C

Note: Absolute maximum rating item indicates the condition which must not be exceeded.

Application of voltage in excess of absolute maximum rating or use out absolute maximum rated temperature environment may cause deterioration of characteristics.

(*1) The voltage difference between inverting input and non-inverting input is the differential input voltage.

Then input terminal voltage is set to more than VEE.

● Electrical characteristics

○ BA10393/BA10339 family (Unless otherwise specified VCC=+5[V], VEE=0[V], Ta=25[°C])

Parameter	Symbol	Temperature range	Guaranteed Limit						Unit	Condition
			BA10393 family			BA10339 family				
			Min.	Typ.	Max.	Min.	Typ.	Max.		
Input Offset Voltage	Vio	25°C	-	±1	±5	-	±2	±5	mV	VOUT=1.4
Input Offset Current	Iio	25°C	-	±5	±50	-	±5	±50	nA	VOUT=1.4
Input Bias Current(*2)	Ib	25°C	-	25	250	-	25	250	nA	VOUT=1.4
Input Common-mode Voltage Range	Vicm	25°C	0	-	VCC-1.5	0	-	VCC-1.5	V	-
Large Signal Voltage Gain	AV	25°C	93	106	-	-	106	-	dB	RL=15[kΩ], VCC=15[V]
Supply Current	ICC	25°C	-	0.4	1	-	0.8	2	mA	RL=∞All Comparators
Output Sink Current	IOL	25°C	6	16	-	6	16	-	mA	VIN=1[V], VIN+=0[V], VOUT=1.5[V]
Output Saturation Voltage	VOL	25°C	-	250	400	-	250	400	mV	VIN=1[V], VIN+=0[V], IOL=4[mA]
Output Leakage Current 1	Ileak1	25°C	-	0.1	-	-	0.1	-	μA	VIN=0[V], VIN+=1[V], VOUT=5[V]
Output Leakage Current 2	Ileak2	25°C	-	0.1	1	-	-	-	μA	VIN=0[V], VIN+=1[V], VOUT=36[V]
Response Time	Tre	25°C	-	1.3	-	-	1.3	-	μs	RL=5.1[kΩ], VRL=5[V]

(*2) Current Direction : Since first input stage is composed with PNP transistor, input bias current flows out of IC.

● Electrical characteristics

○ BA2903/BA2901 family (Unless otherwise specified VCC=+5[V], VEE=0[V], full range -40[°C] to +125[°C])

Parameter	Symbol	Temperature range	Guaranteed Limit						Unit	Condition
			BA2903 family			BA2901 family				
			Min.	Typ.	Max.	Min.	Typ.	Max.		
Input Offset Voltage (*3)	VIO	25°C	-	2	7	-	2	7	mV	VOUT=1.4[V]
		full range	-	-	15	-	-	15		VCC=5 to 36[V], VOUT=1.4[V]
Input Offset Current (*3)	Iio	25°C	-	5	50	-	5	50	nA	VOUT=1.4[V]
		full range	-	-	200	-	-	200		
Input Bias Current (*3)	Ib	25°C	-	50	250	-	50	250	nA	VOUT=1.4[V]
		full range	-	-	500	-	-	500		
Input Common-mode voltage Range	Vicm	25°C	0	-	VCC-1.5	0	-	VCC-1.5	V	-
Large Signal Voltage Gain	AV	25°C	88	100	-	88	100	-	dB	VCC=15[V], VOUT=1.4 to 11.4[V] RL=15[kΩ], VRL=15[V]
Supply Current	ICC	25°C	-	0.6	1	-	0.8	2	mA	VOUT=open
		full range	-	-	2.5	-	-	2.5		VOUT=open, VCC=36[V]
Output Sink Current(*4)	IOL	25°C	6	16	-	6	16	-	mA	VIN+=0[V], VIN=1[V], VOL=1.5[V]
Output Saturation Voltage (Low Level Output Voltage)	VOL	25°C	-	150	400	-	150	400	mV	VIN+=0[V], VIN-=1[V], IOL=4[mA]
		full range	-	-	700	-	-	700		
Output Leakage current (High Level Output Current)	Ileak	25°C	-	0.1	-	-	0.1	-	μA	VIN+=1[V], VIN-=0[V], VOH=5[V]
		full range	-	-	1	-	-	1		VIN+=1[V], VIN-=0[V], VOH=36[V]
Response Time	Tre	25°C	-	1.3	-	-	1.3	-	μs	RL=5.1[kΩ], VRL=5[V] VIN=100[mVp-p], overdrive=5[mV]
			-	0.4	-	-	0.4	-		RL=5.1[kΩ], VRL=5[V], VIN=TTL Logic Swing, VREF=1.4[V]

(*3) Absolute values

● BA10393 family

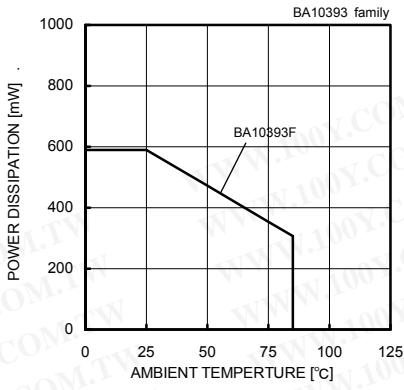

Fig.1 Derating Curve

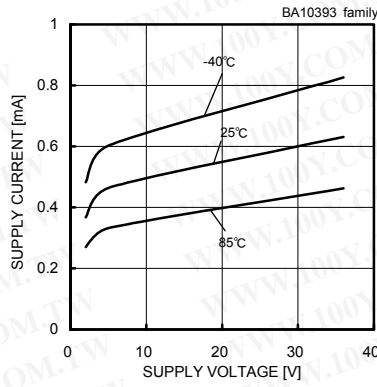

Fig.2 Supply Current - Supply Voltage

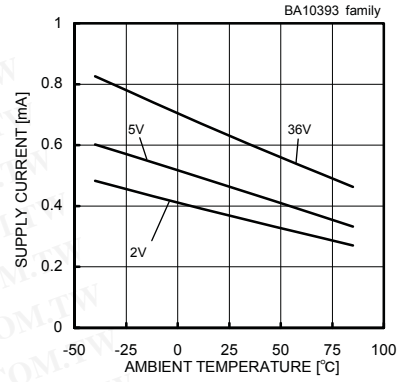

Fig.3 Supply Current - Ambient Temperature

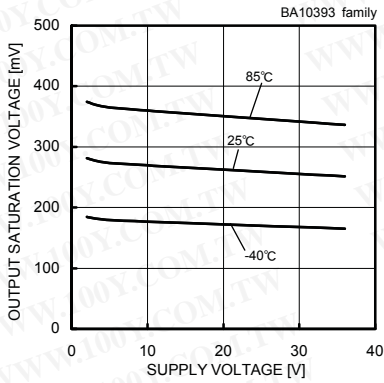

Fig.4 Output Saturation Voltage - Supply Voltage (IOL=4[mA])

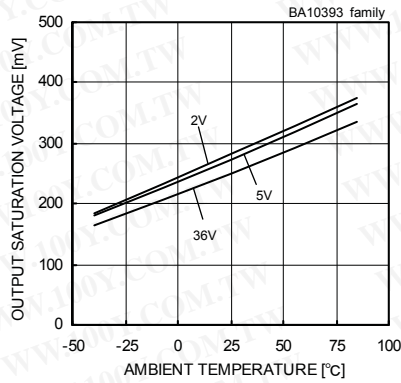

Fig.5 Output Saturation Voltage - Ambient Temperature (IOL=4[mA])

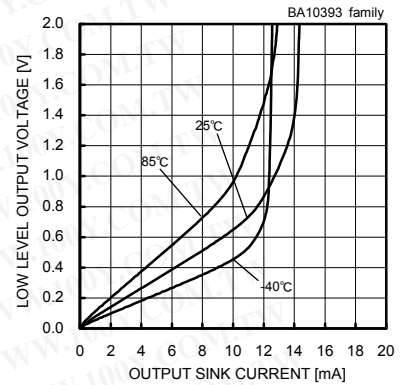

Fig.6 Low Level Output Voltage - Output Sink Current (VCC=5[V])

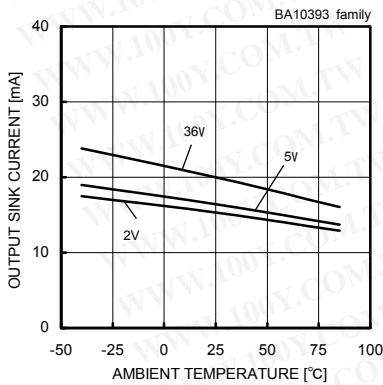

Fig.7 Output Sink Current - Ambient Temperature (VOUT=1.5[V])

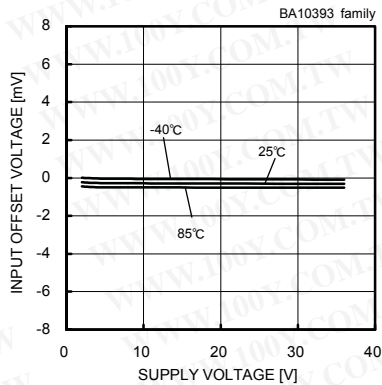

Fig.8 Input Offset Voltage - Supply Voltage

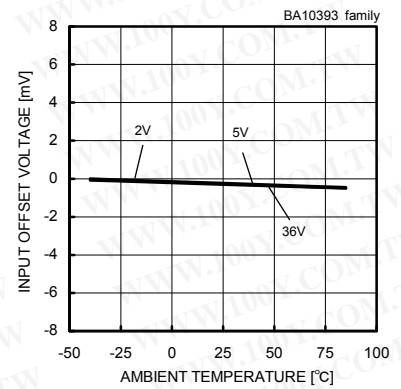

Fig.9 Input Offset Voltage - Ambient Temperature

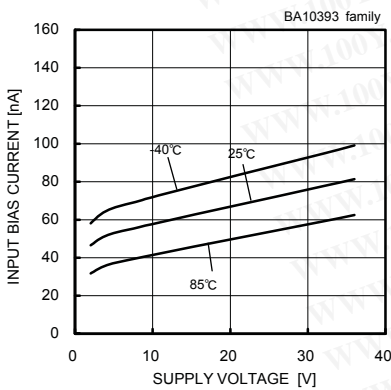

Fig.10 Input Bias Current - Supply Voltage

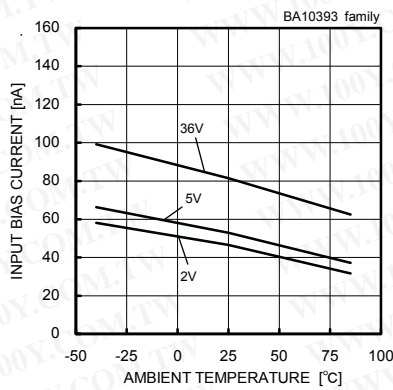

Fig.11 Input Bias Current - Ambient Temperature

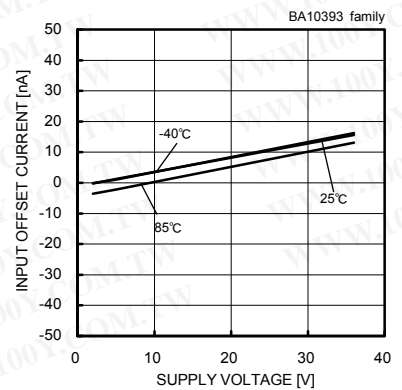

Fig.12 Input Offset Current - Supply Voltage

(*) The above data is ability value of sample, it is not guaranteed.

● BA10393 family

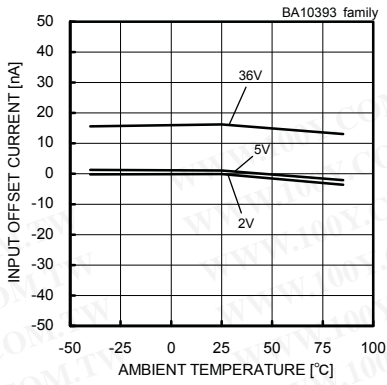

Fig.13
Input Offset Current – Ambient Temperature

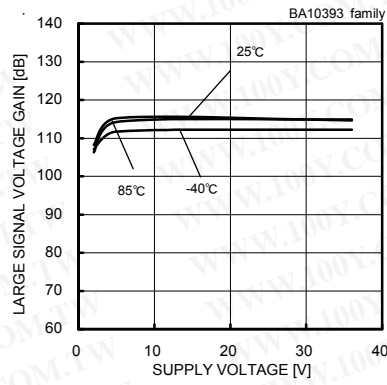

Fig.14
Large Signal Voltage Gain – Supply Voltage

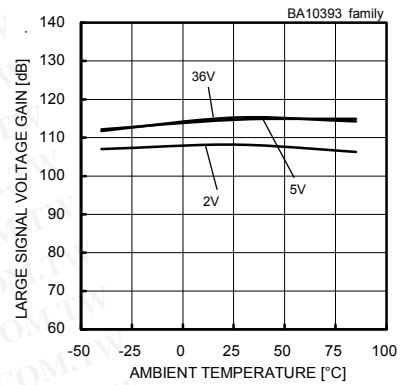

Fig.15
Large Signal Voltage Gain – Ambient Temperature

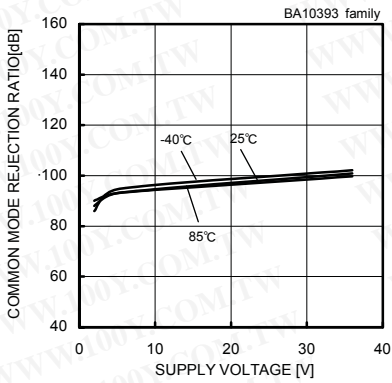

Fig.16
Common-mode Rejection Ratio – Supply Voltage

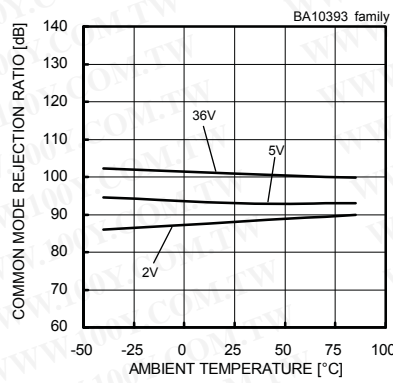

Fig.17
Common-mode Rejection Ratio – Ambient Temperature

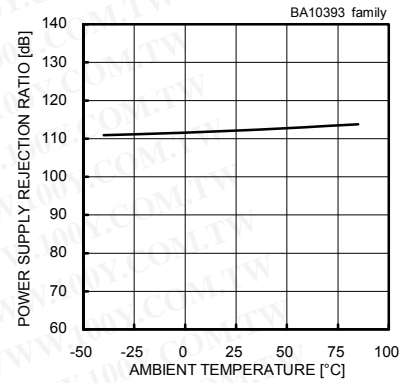

Fig.18
Power Supply Rejection Ratio – Ambient Temperature

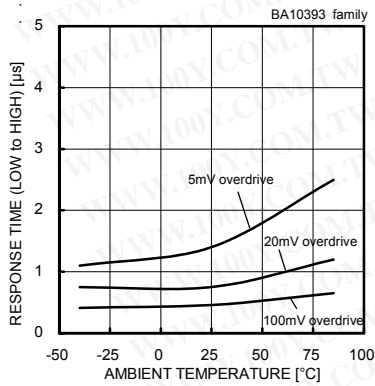

Fig.19
Response Time LH – Ambient Temperature
(VCC=5[V],VRL=5[V],RL=5.1[kΩ])

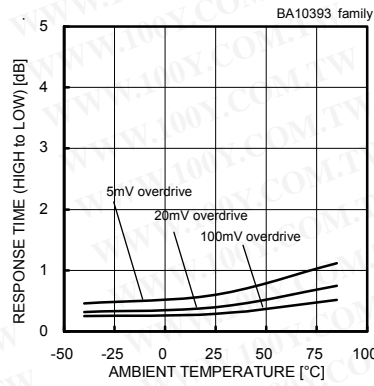

Fig.20
Response Time HL – Ambient Temperature
(VCC=5[V],VRL=5[V],RL=5.1[kΩ])

(*) The above date is ability value of sample, it is not guaranteed.

● BA10339 family

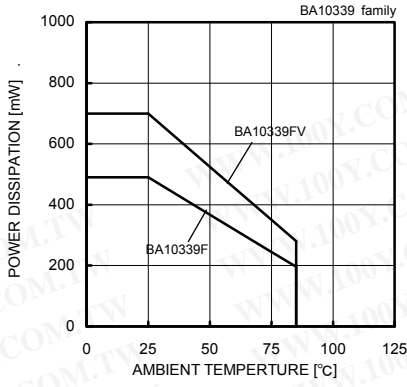

Fig.1 Derating Curve

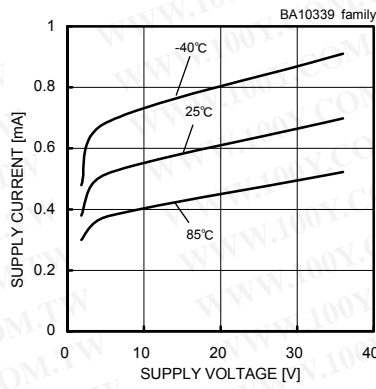

Fig.2 Supply Current - Supply Voltage

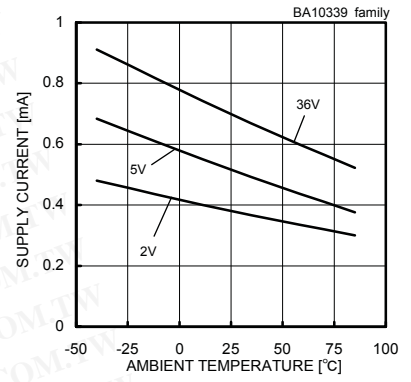

Fig.3 Supply Current - Ambient Temperature

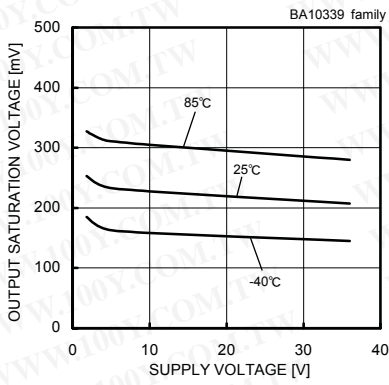

Fig.4 Output Saturation Voltage - Supply Voltage (IOL=4[mA])

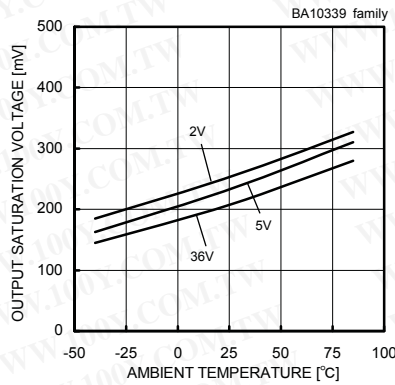

Fig.5 Output Saturation Voltage - Ambient Temperature (IOL=4[mA])

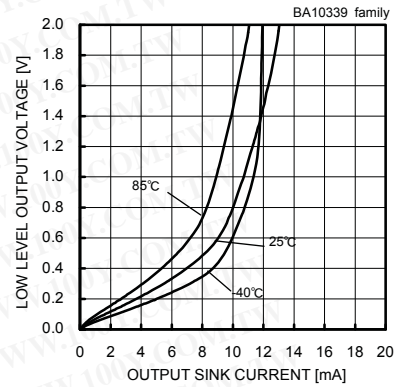

Fig.6 Low Level Output Voltage - Ambient Temperature (VCC=5[V])

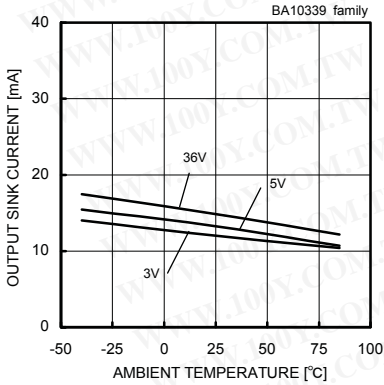

Fig.7 Output Sink Current - Ambient Temperature (VOL=1.5[V])

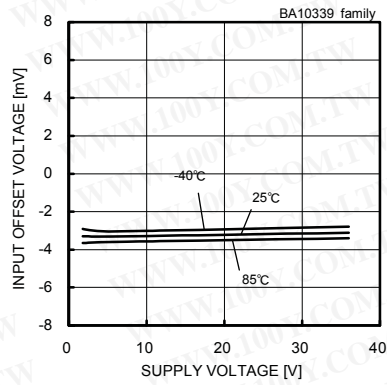

Fig.8 Input Offset Voltage - Supply Voltage

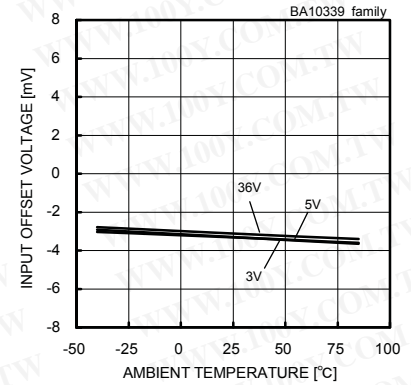

Fig.9 Input Offset Voltage - Ambient Temperature

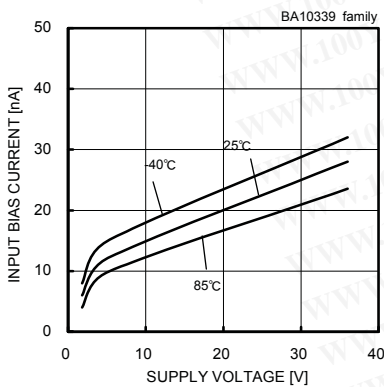

Fig.10 Input Bias Current - Supply Voltage

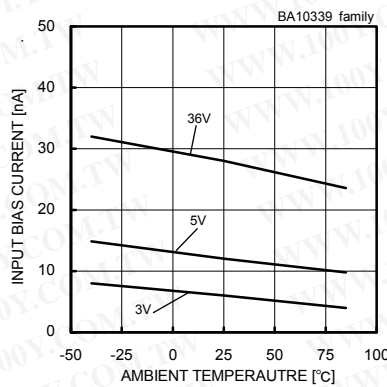

Fig.11 Input Bias Current - Ambient Temperature

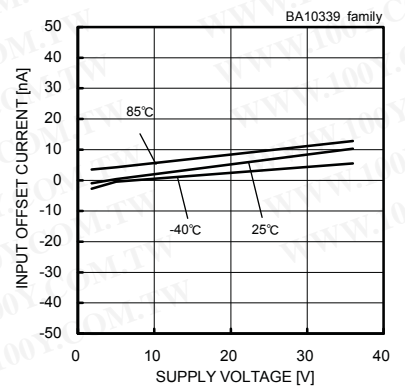

Fig.12 Input Offset Current - Supply Voltage

(*) The above data is ability value of sample, it is not guaranteed.

● BA10339 family

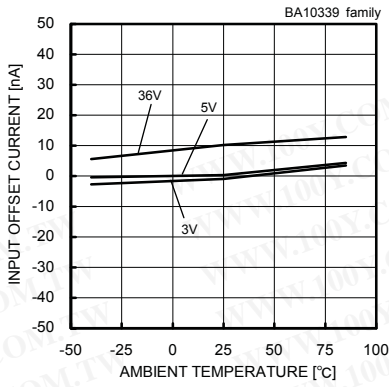

Fig. 13
Input Offset Current – Ambient Temperature

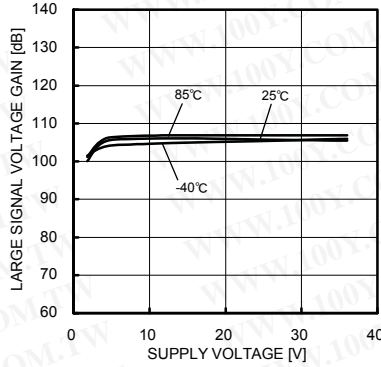

Fig. 14
Large Signal Voltage Gain – Supply Voltage

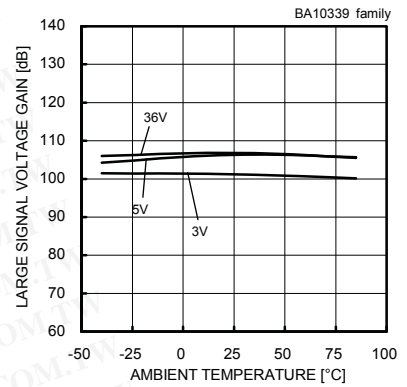

Fig. 15
Large Signal Voltage Gain – Ambient Temperature

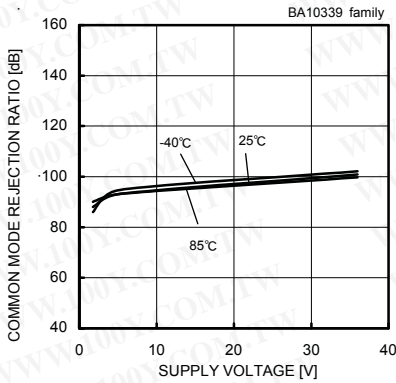

Fig. 16
Common-mode Rejection Ratio – Supply Voltage

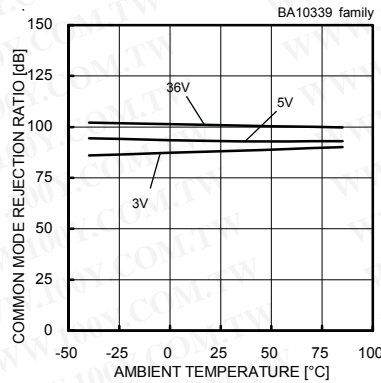

Fig. 17
Common-mode Rejection Ratio – Ambient Temperature

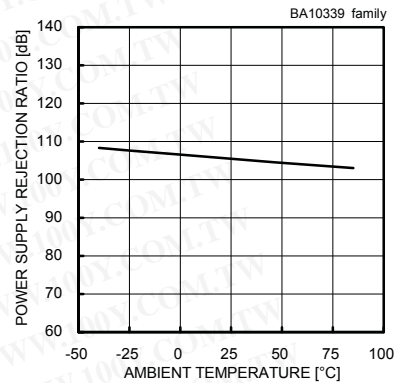

Fig. 18
Power Supply Rejection Ratio – Ambient Temperature

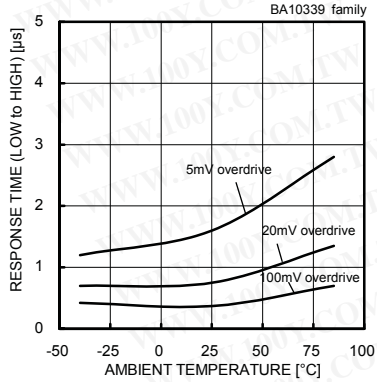

Fig. 19
Response Time LH – Ambient Temperature
(VCC=5[V], VRL=5[V], RL=5.1[kΩ])

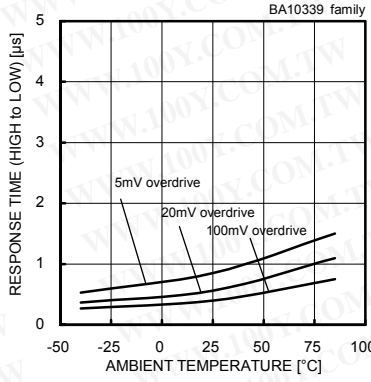

Fig. 20
Response Time HL – Ambient Temperature
(VCC=5[V], VRL=5[V], RL=5.1[kΩ])

勝特力材料 886-3-5753170
 勝特力电子(上海) 86-21-34970699
 勝特力电子(深圳) 86-755-83298787
[Http://www.100y.com.tw](http://www.100y.com.tw)

(*) The above date is ability value of sample, it is not guaranteed.

○BA2903 family

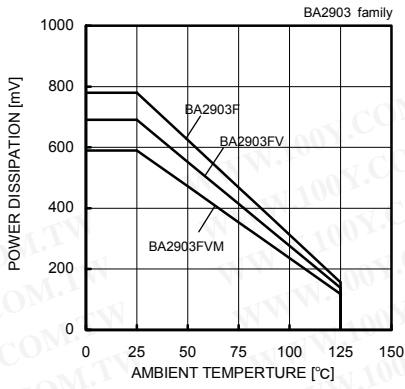

Fig.1 Derating Curve

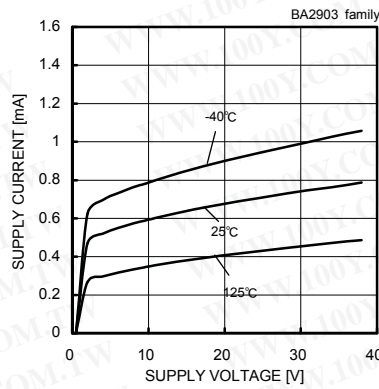

Fig.2 Supply Current - Supply Voltage

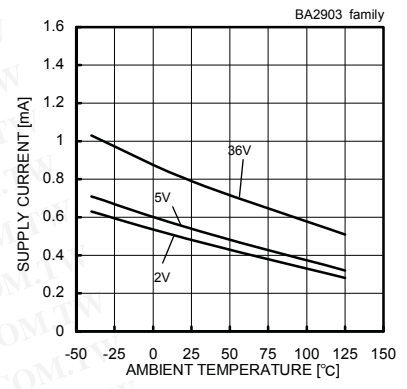

Fig.3 Supply Current - Ambient Temperature

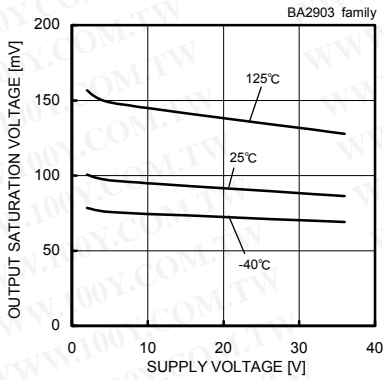

Fig.4 Output Saturation Voltage - Supply Voltage (IOL=4[mA])

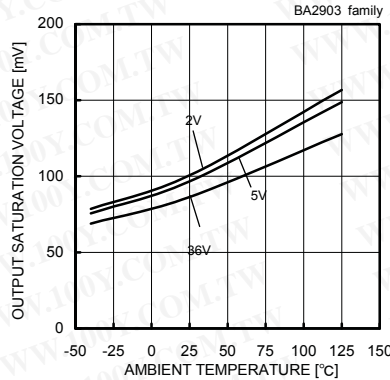

Fig.5 Output Saturation Voltage - Ambient Temperature (IOL=4[mA])

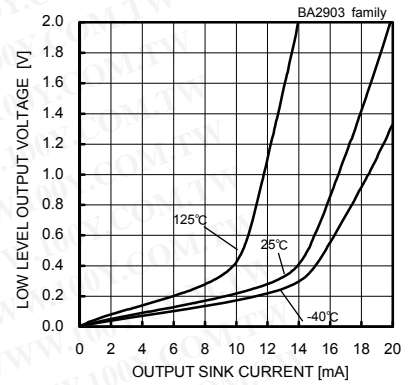

Fig.6 Low Level Output Voltage - Output Sink Current (VCC=5[V])

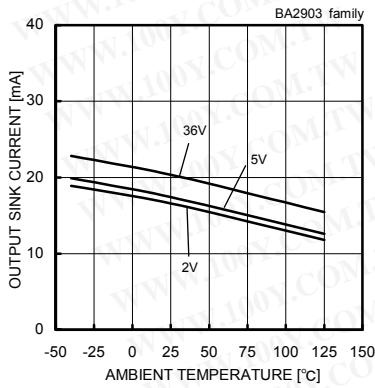

Fig.7 Output Sink Current - Ambient Temperature (VOUT=1.5[V])

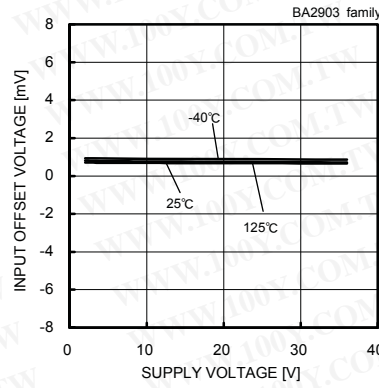

Fig.8 Input Offset Voltage - Supply Voltage

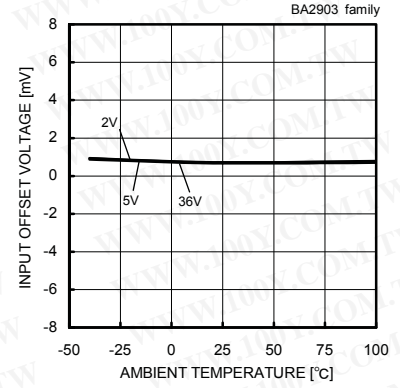

Fig.9 Input Offset Voltage - Ambient Temperature

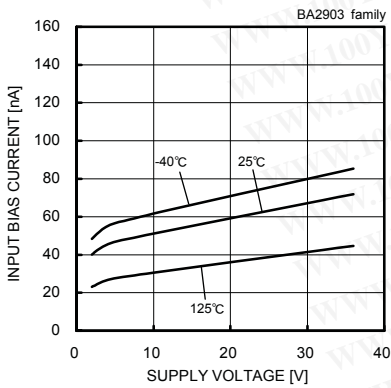

Fig.10 Input Bias Current - Supply Voltage

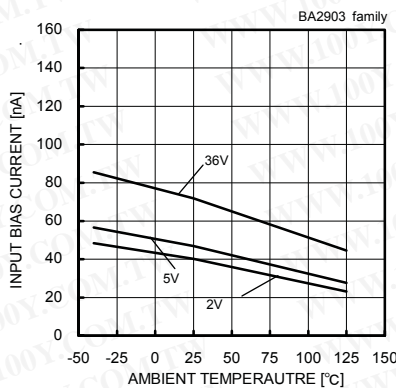

Fig.11 Input Bias Current - Ambient Temperature

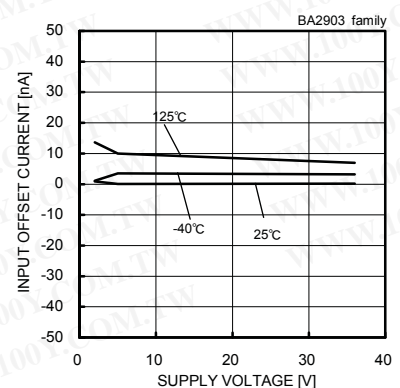

Fig.12 Input Offset Current - Supply Voltage

(*) The above data is ability value of sample, it is not guaranteed.

●BA2903 family

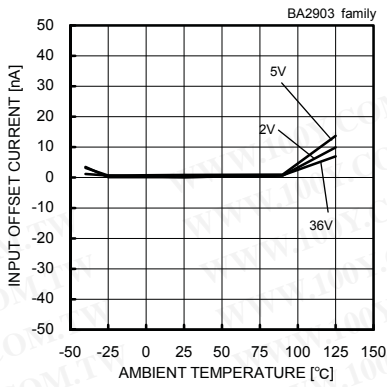

Fig. 13
Input Offset Current - Ambient Temperature

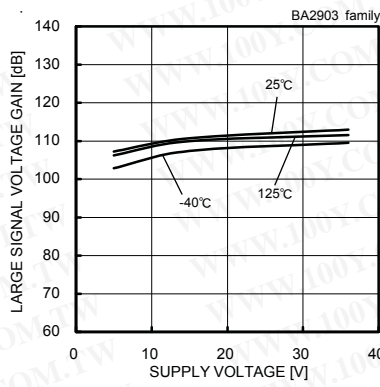

Fig. 14
Large Signal Voltage Gain - Supply Voltage

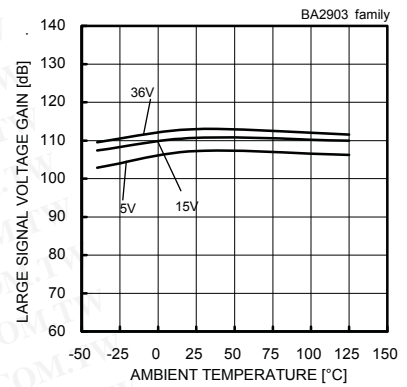

Fig. 15
Large Signal Voltage Gain - Ambient Temperature

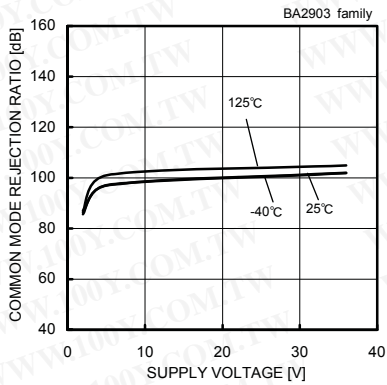

Fig. 16
Common Mode Rejection Ratio - Supply Voltage

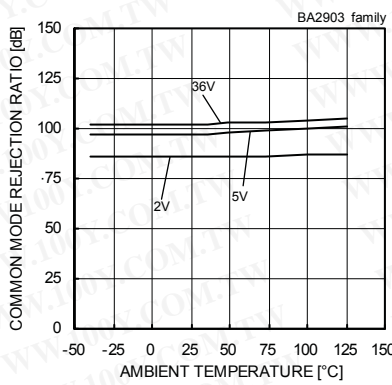

Fig. 17
Common Mode Rejection Ratio - Ambient Temperature

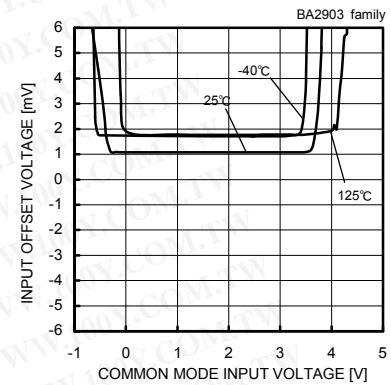

Fig. 18
Input Offset Voltage - Common Mode Input Voltage (VCC=5V)

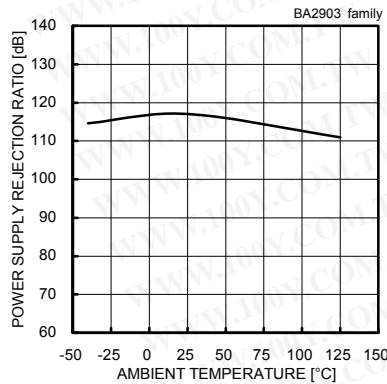

Fig. 19
Power Supply Rejection Ratio - Ambient Temperature

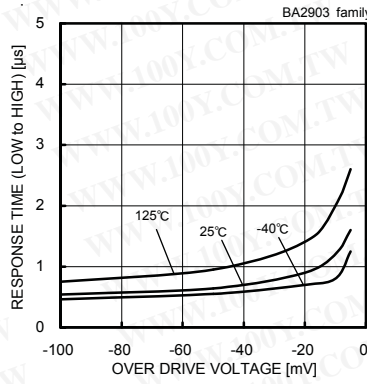

Fig. 20
Response Time - Over Drive Voltage (VCC=5[V], VRL=5[V], RL=5.1[kΩ])

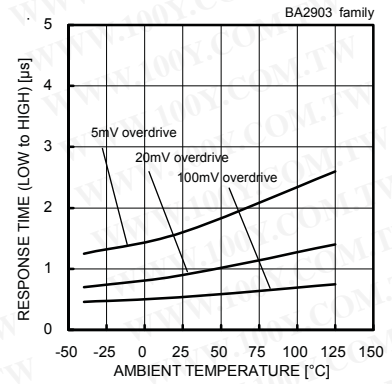

Fig. 21
Response Time - Ambient Temperature (VCC=5[V], VRL=5[V], RL=5.1[kΩ])

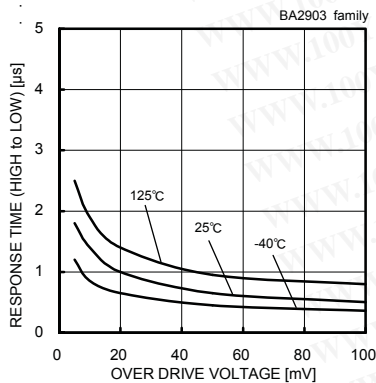

Fig. 22
Response Time - Over Drive Voltage (VCC=5[V], VRL=5[V], RL=5.1[kΩ])

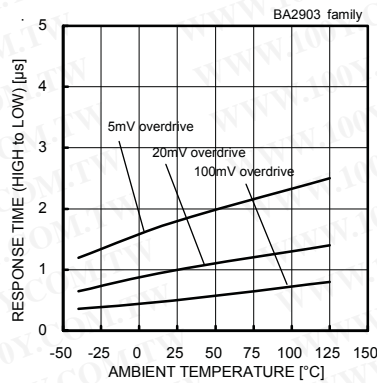

Fig. 23
Response Time - Ambient Temperature (VCC=5[V], VRL=5[V], RL=5.1[kΩ])

勝特力材料 886-3-5753170
 勝特力电子(上海) 86-21-34970699
 勝特力电子(深圳) 86-755-83298787
[Http://www.100y.com.tw](http://www.100y.com.tw)

(*) The above date is ability value of sample, it is not guaranteed.

● BA2901 family

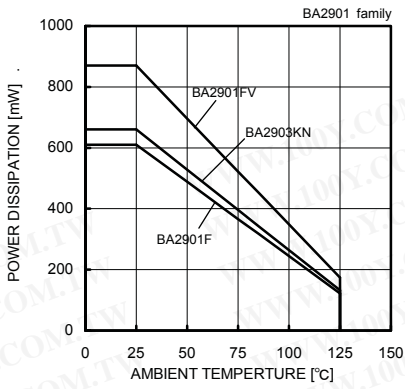

Fig.1 Derating Curve

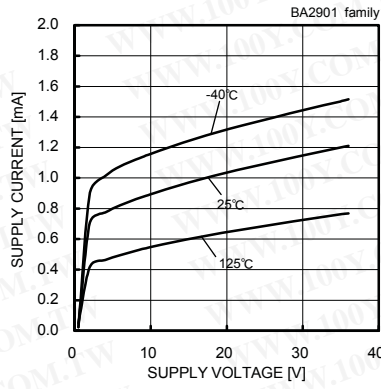

Fig.2 Supply Current - Supply Voltage

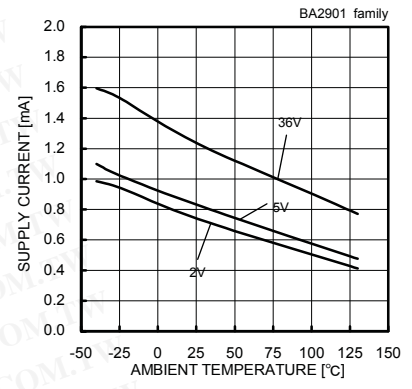

Fig.3 Supply Current - Ambient Temperature

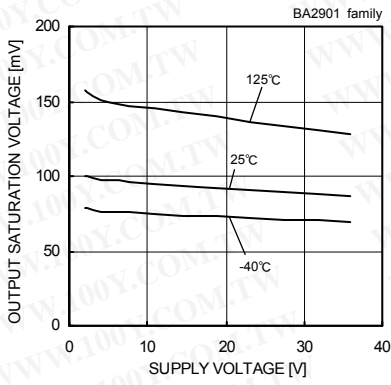

Fig.4 Output Saturation Voltage - Supply Voltage (IOL=4[mA])

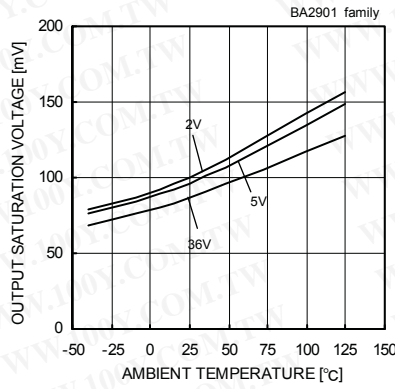

Fig.5 Output Saturation Voltage - Ambient Temperature (IOL=4[mA])

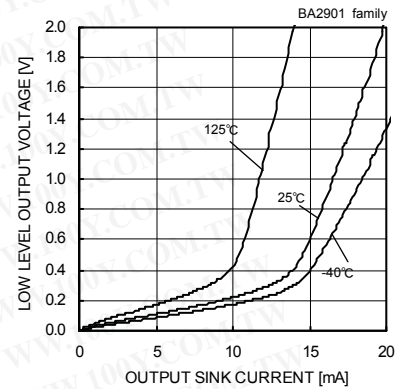

Fig.6 Low Level Output Voltage - Output Sink Current (VCC=5[V])

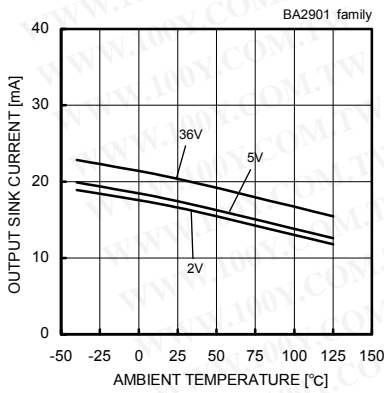

Fig.7 Output Sink Current - Ambient Temperature (VOL=1.5[V])

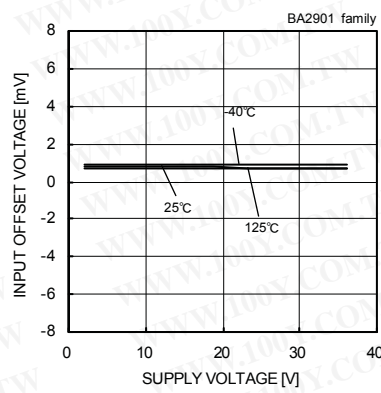

Fig.8 Input Offset Voltage - Supply Voltage

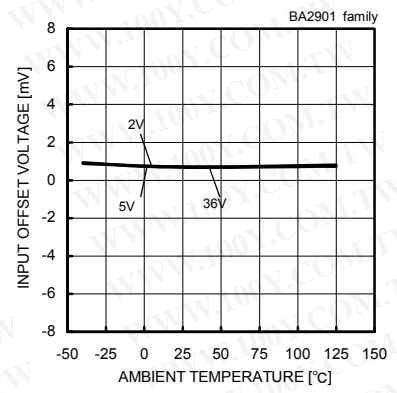

Fig.9 Input Offset Voltage - Ambient Temperature

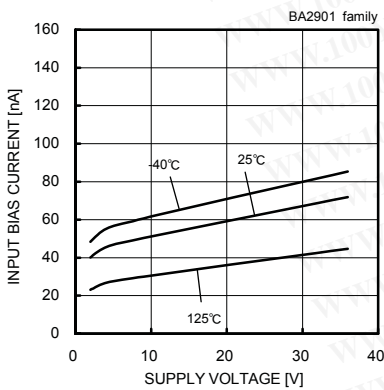

Fig.10 Input Bias Current - Supply Voltage

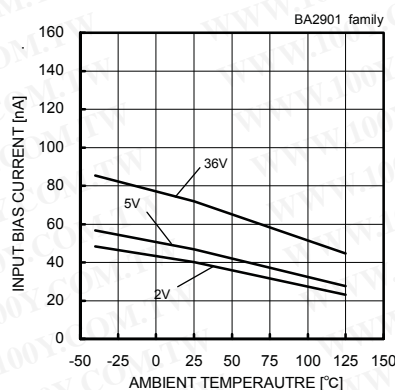

Fig.11 Input Bias Current - Ambient Temperature

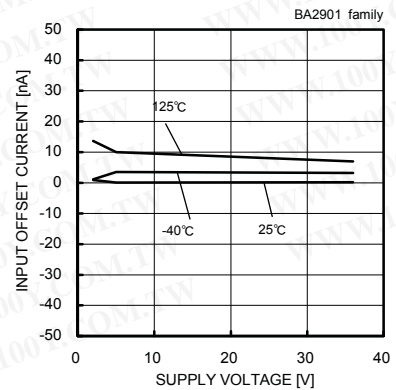

Fig.12 Input Offset Current - Supply Voltage

(*) The above data is ability value of sample, it is not guaranteed.

●BA2901 family

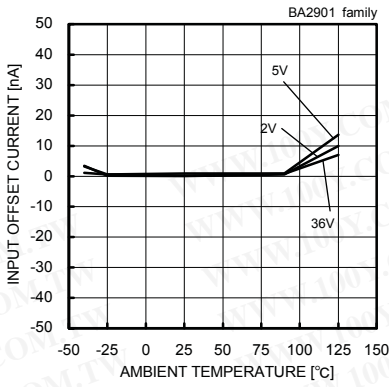

Fig.13
Input Offset Current – Ambient Temperature

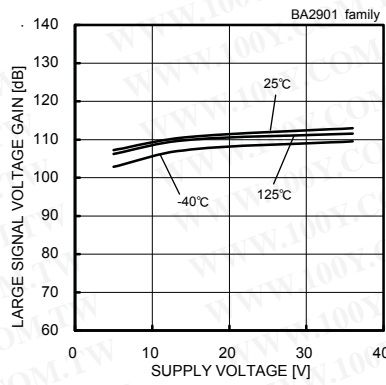

Fig.14
Large Signal Voltage Gain – Supply Voltage

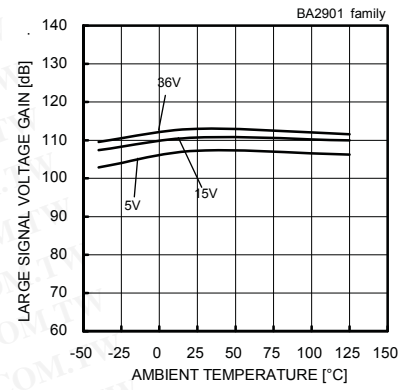

Fig.15
Large Signal Voltage Gain – Ambient Temperature

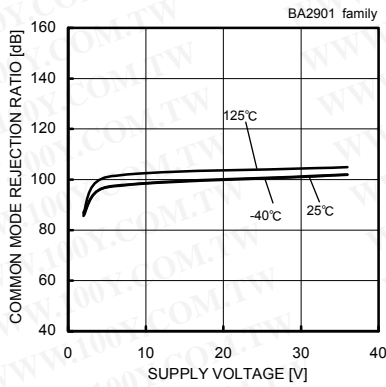

Fig.16
Common Mode Rejection Ratio – Supply Voltage

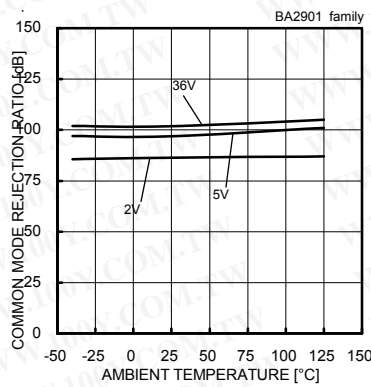

Fig.17
Common Mode Rejection Ratio – Ambient Temperature

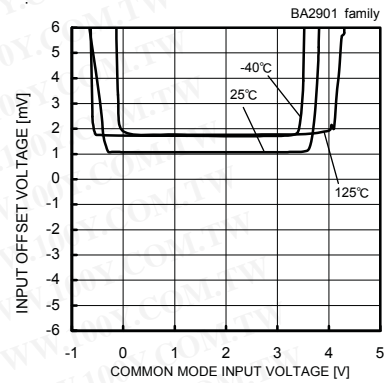

Fig.18
Input Offset Voltage – Common Mode Input Voltage (VCC=5V)

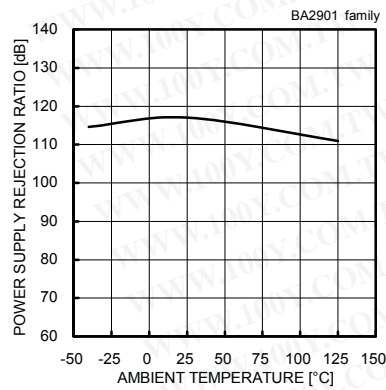

Fig.19
Power Supply Rejection Ratio – Ambient Temperature

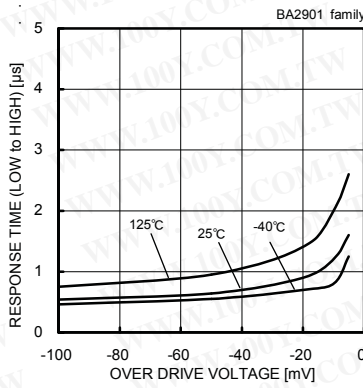

Fig.20
Response Time – Over Drive Voltage (VCC=5[V],VRL=5[V],RL=5.1[kΩ])

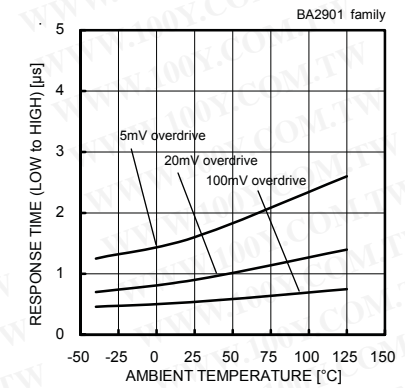

Fig.21
Response Time – Ambient temperature (VCC=5[V],VRL=5[V],RL=5.1[kΩ])

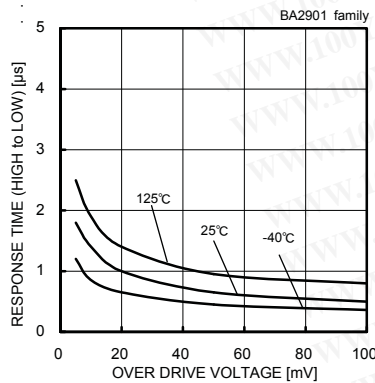

Fig.22
Response Time – Over Drive Voltage (VCC=5[V],VRL=5[V],RL=5.1[kΩ])

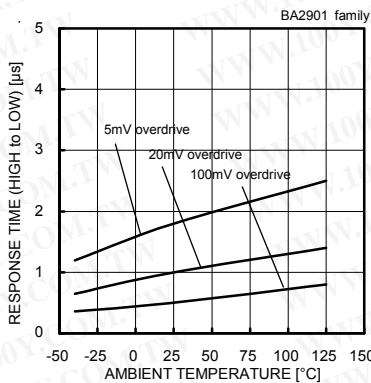

Fig.23
Response Time – Ambient Temperature (VCC=5[V],VRL=5[V],RL=5.1[kΩ])

勝特力材料 886-3-5753170
 勝特力电子(上海) 86-21-34970699
 勝特力电子(深圳) 86-755-83298787
[Http://www.100y.com.tw](http://www.100y.com.tw)

(*) The above data is ability value of sample, it is not guaranteed.

● Schematic Diagram

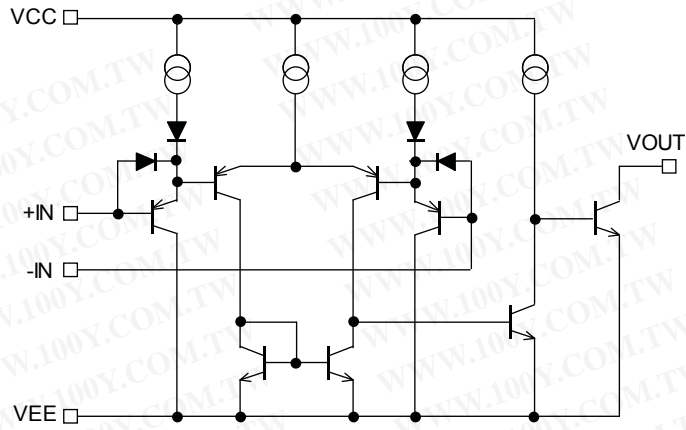

Fig.1 Schematic Diagram (one channel only)

● Test Circuit1 Null Method

VCC,VEE,EK,Vicm, Unit : [V] , VRL= [VCC]

Parameter	VF	S1	S2	S3	BA10393/BA10339 family				BA2903/BA2901 family				Calculation
					Vcc	GND	EK	Vicm	Vcc	GND	EK	Vicm	
Input Offset Voltage	VF1	ON	ON	ON	5	0	-1.4	0	5 to 36	0	-1.4	0	1
Input Offset Current	VF2	OFF	OFF	ON	5	0	-1.4	0	5	0	-1.4	0	2
Input Bias Current	VF3	OFF	ON	ON	5	0	-1.4	0	5	0	-1.4	0	3
	VF4	ON	OFF		5	0	-1.4	0	5	0	-1.4	0	
Large Signal Voltage Gain	VF5	ON	ON	ON	15	0	-1.4	0	15	0	-1.4	0	4
	VF6				15	0	-11.4	0	15	0	-11.4	0	

— Calculation —

1. Input Offset Voltage (Vio)

$$V_{io} = \frac{|VF1|}{1 + R_f/R_s} \text{ [V]}$$

2. Input Offset Current (Iio)

$$I_{io} = \frac{|VF2 - VF1|}{R_i(1 + R_f/R_s)} \text{ [A]}$$

3. Input Bias Current (Ib)

$$I_b = \frac{|VF4 - VF3|}{2 \times R_i(1 + R_f/R_s)} \text{ [A]}$$

4. Large Signal Voltage Gain (AV)

$$A_v = 20 \times \text{Log} \frac{\Delta E_k \times (1 + R_f/R_s)}{|VF5 - VF6|} \text{ [dB]}$$

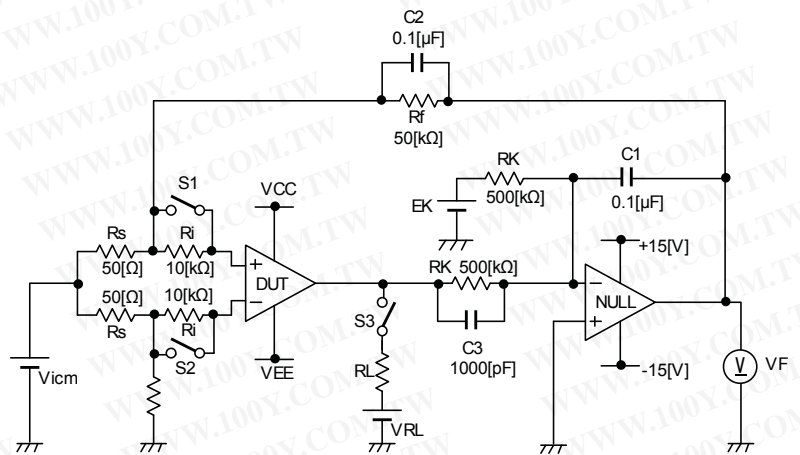

Fig.2 Test Circuit 1 (one channel only)

勝特力材料 886-3-5753170
 勝特力电子(上海) 86-21-34970699
 勝特力电子(深圳) 86-755-83298787
[Http://www.100y.com.tw](http://www.100y.com.tw)

● Test Circuit2 Switch Condition

Unit : [V]

SW No.		SW 1	SW 2	SW 3	SW 4	SW 5	SW 6	SW 7
Supply Current		OFF	OFF	OFF	OFF	OFF	OFF	OFF
Output Sink Current	VOL=1.5[V]	OFF	ON	ON	OFF	OFF	OFF	ON
Output Saturation Voltage	IOL=4[mA]	OFF	ON	ON	OFF	ON	ON	OFF
Output Leakage Current	VOH=36[V]	OFF	ON	ON	OFF	OFF	OFF	ON
Response Time	RL=5.1[kΩ] VRL=5[V]	ON	OFF	ON	ON	OFF	OFF	OFF

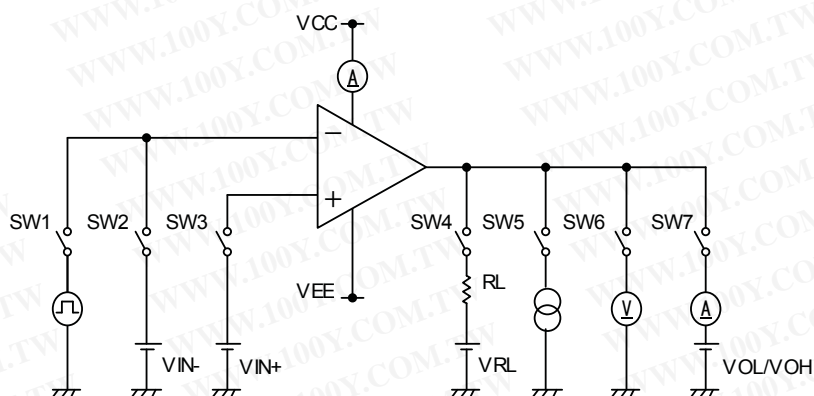

Fig.3 Test Circuit2 (one channel only)

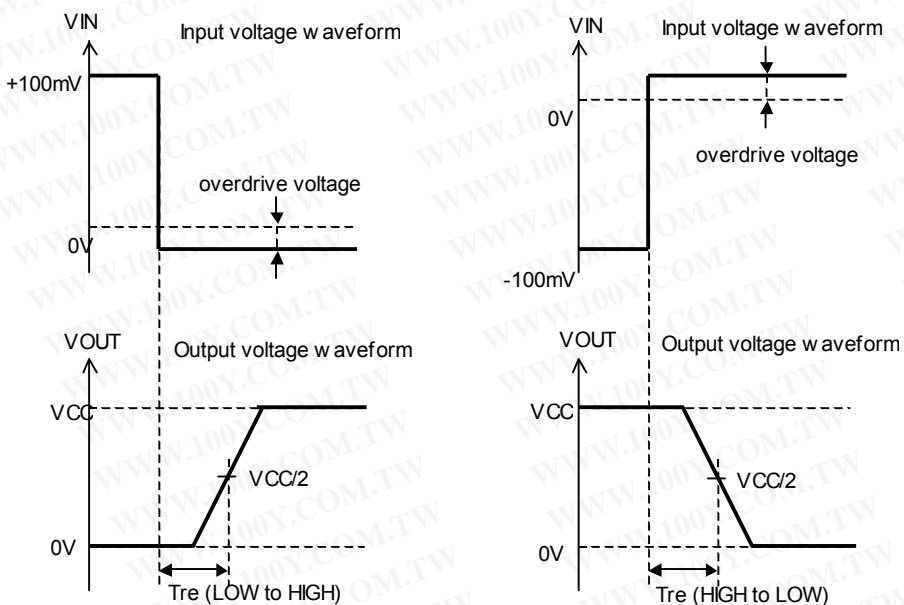

Fig.4 Response Time

勝特力材料 886-3-5753170
 勝特力电子(上海) 86-21-34970699
 勝特力电子(深圳) 86-755-83298787
[Http://www.100y.com.tw](http://www.100y.com.tw)

● Description of electrical characteristics

Described here are the terms of electric characteristics used in this technical note. Items and symbols used are also shown.
Note that item name and symbol and their meaning may differ from those on another manufacture's document or general document.

1. Absolute maximum ratings

Absolute maximum rating item indicates the condition which must not be exceeded. Application of voltage in excess of absolute Maximum rating or use out of absolute maximum rated temperature environment may cause deterioration of characteristics.

- 1.1 Power supply voltage (VCC—VEE)
Indicates the maximum voltage that can be applied between the positive power supply terminal and negative power supply terminal Without deterioration or destruction of characteristics of internal circuit.
- 1.2 Differential input voltage (Vid)
Indicates the maximum voltage that can be applied between non-inverting terminal and inverting terminal without deterioration and Destruction of characteristics of IC.
- 1.3 Input common-mode voltage range (Vicm)
Indicates the maximum voltage that can be applied to non-inverting terminal and inverting terminal without deterioration or destruction of Characteristics. Input common-mode voltage range of the maximum ratings not assure normal operation of IC. When normal Operation of IC is desired, the input common-mode voltage of characteristics item must be followed.
- 1.4 Operating temperature range and storage temperature range (Topr, Tstg)
Operating temperature range indicates the temperature range where IC can operate. The higher the ambient temperature becomes, the lower is the power consumed by IC. Storage temperature range where IC can be stored without excessive deterioration of characteristics Of IC.
- 1.5 Power dissipation (Pd)
Indicates the power that can be consumed by specified mounted board at the ambient temperature 25°C(normal temperature). As for Package product, Pd is determined by the temperature that can be permitted by IC chip in the package (maximum junction temperature) and thermal resistance of the package

2. Electrical characteristics item

- 2.1 Input offset voltage (Vio)
Indicates the voltage difference between non-inverting terminal and inverting terminal. It can be translated into the input voltage difference required for setting the output voltage at 0 [V]
- 2.2 Input offset current (Iio)
Indicates the difference of input bias current between non-inverting terminal and inverting terminal.
- 2.3 Input bias current (Ib)
Indicates the current that flows into or out of the input terminal. It is defined by the average of input bias current at non-inverting terminal and input bias current at inverting terminal.
- 2.4 Input common-mode voltage range (Vicm)
Indicates the input voltage range where IC operates normally.
- 2.5 Large signal voltage gain (AV)
Indicates the amplifying rate (gain) of output voltage against the voltage difference between non-inverting terminal and inverting terminal. It is normally the amplifying rate (gain) with reference to DC voltage.
$$A_v = (\text{Output voltage fluctuation}) / (\text{Input offset fluctuation})$$
- 2.6 Circuit current (ICC)
Indicates the IC current that flows under specified conditions and no-load steady status.
- 2.7 Output sink current (OL)
Indicates the maximum current that can be output under specified output condition (such as output voltage and load condition).
- 2.8 Output saturation voltage, Low level output voltage (VOL)
Indicates the voltage range that can be output under specified load conditions.
- 2.9 Output leakage current, High level output current (Ileak)
Indicates the current that flows into IC under specified input and output conditions.
- 2.10 Response Time (Tre)
The interval between the application of an input and output condition.
- 2.11 Common-mode rejection ratio (CMRR)
Indicates the ratio of fluctuation of input offset voltage when in-phase input voltage is changed. It is normally the fluctuation of DC.
$$CMRR = (\text{Change of Input common-mode voltage}) / (\text{Input offset fluctuation})$$
- 2.12 Power supply rejection ratio (PSRR)
Indicates the ratio of fluctuation of input offset voltage when supply voltage is changed. It is normally the fluctuation of DC.
$$PSRR = (\text{Change of power supply voltage}) / (\text{Input offset fluctuation})$$

勝特力材料 886-3-5753170
勝特力电子(上海) 86-21-34970699
勝特力电子(深圳) 86-755-83298787
[Http://www.100y.com.tw](http://www.100y.com.tw)

● Derating curve

Power dissipation (total loss) indicates the power that can be consumed by IC at Ta=25°C (normal temperature). IC is heated when it consumed power, and the temperature of IC chip becomes higher than ambient temperature. The temperature that can be accepted by IC chip depends on circuit configuration, manufacturing process, and consumable power is limited. Power dissipation is determined by the temperature allowed in IC chip (maximum junction temperature) and thermal resistance of package (heat dissipation capability). The maximum junction temperature is typically equal to the maximum value in the storage temperature range. Heat generated by consumed power of IC radiates from the mold resin or lead frame of the package. The parameter which indicates this heat dissipation capability (hardness of heat release) is called thermal resistance, represented by the symbol θ_{ja} [°C/W]. The temperature of IC inside the package can be estimated by this thermal resistance. Fig.6 (a) shows the model of thermal resistance of the package. Thermal resistance θ_{ja} , ambient temperature Ta, junction temperature Tj, and power dissipation Pd can be calculated by the equation below :

$$\theta_{ja} = (T_j - T_a) / P_d \quad [^{\circ}\text{C}/\text{W}] \quad \dots \dots (1)$$

Derating curve in Fig.6 (b) indicates power that can be consumed by IC with reference to ambient temperature. Power that can be consumed by IC begins to attenuate at certain ambient temperature. This gradient is determined by thermal resistance θ_{ja} . Thermal Resistance θ_{ja} depends on chip size, power consumption, package, ambient temperature, package condition, wind velocity, etc even when the same of package is used. Thermal reduction curve indicates a reference value measured at a specified condition. Fig 1 (a)-(d) show a derating curve for an example of BA10393, BA10339, BA2903, and BA2901.

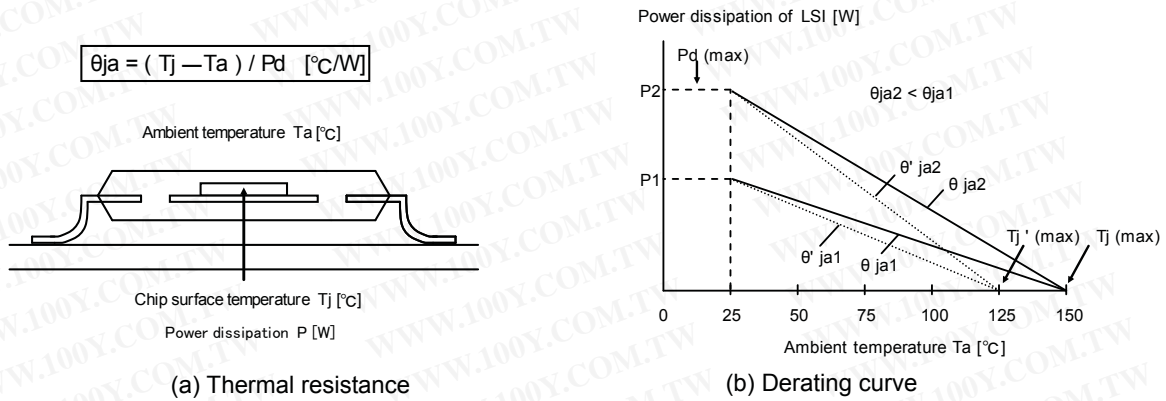
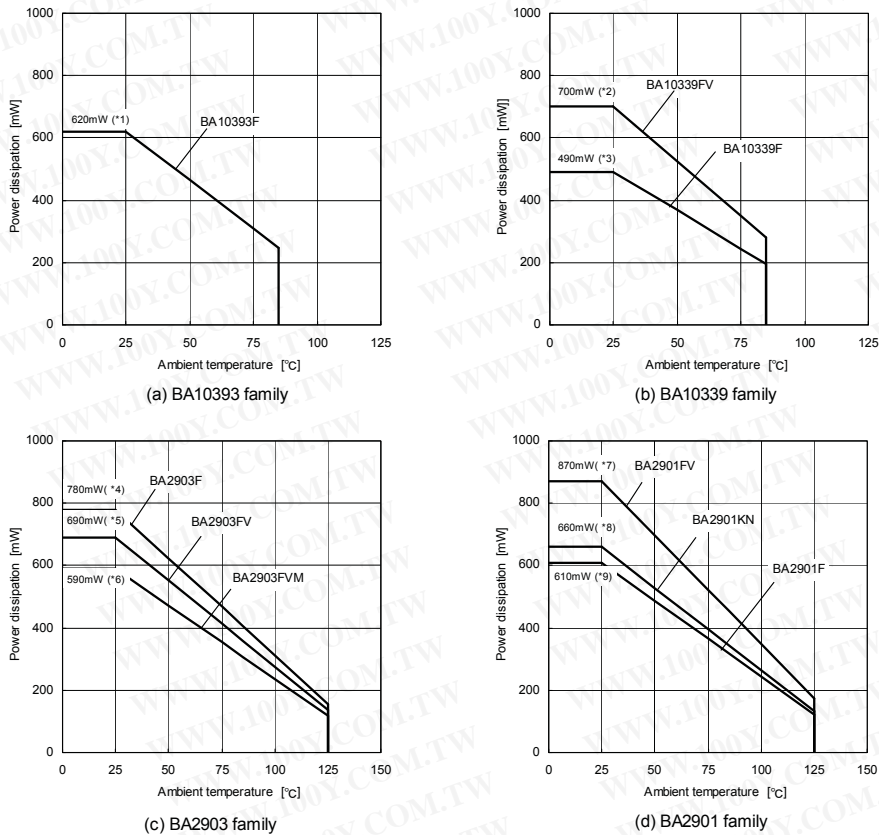

Fig.1 Thermal resistance and derating curve



(*1)	(*2)	(*3)	(*4)	(*5)	(*6)	(*7)	(*8)	(*9)	Unit
6.2	7.0	4.9	6.2	5.5	4.7	7.0	5.3	4.9	[mW/°C]

When using the unit above Ta=25°C, subtract the value above per degree°C. Permissible dissipation is the value when FR4 glass epoxy board 70[mm]×70[mm]×1.6[mm] (copper foil area below 3[%]) is mounted.

勝特力材料 886-3-5753170
勝特力电子(上海) 86-21-34970699
勝特力电子(深圳) 86-755-83298787
[Http://www.100y.com.tw](http://www.100y.com.tw)

Fig.2 Derating Curve

●Cautions on use

1) Processing of unused circuit

It is recommended to apply connection (see the Fig.9) and set the noninverting input terminal at the potential within input common-mode voltage range (Vicm), for any unused circuit.

2) Input voltage

Applying VEE+36[V](BA2903/BA2901 family) to the input terminal is possible without causing deterioration of the electrical characteristics or destruction, irrespective of the supply voltage. However, this does not ensure normal circuit operation. Please note that the circuit operates normally only when the input voltage is within the common mode input voltage range of the electrical characteristics.

3) Maximum output voltage

Because the output voltage range becomes narrow as the output current increases, design the application with margin by considering changes in electrical characteristics and temperature characteristics.

4) Short-circuit of output terminal

When output terminal and VCC or VEE terminal are shorted, excessive output current may flow under some conditions, and heating may destroy IC. It is necessary to connect a resistor as shown in Fig. 10, thereby Protecting against load shorting.

5) Power supply (split supply / single supply) in used

Op amp operates when specified voltage is applied between VCC and VEE. Therefore, the single supply Op Amp can be used for double supply Op-Amp as well.

6) Power dissipation (Pd)

Use a thermal design that allows for a sufficient margin in light of the power dissipation (Pd) in actual operating conditions.

7) Short-circuit between pins and wrong mounting

Pay attention to the assembly direction of the ICs. Wrong mounting direction or shorts between terminals, GND, or other components on the circuits, can damage the IC.

8) Use in strong electromagnetic field

Using the ICs in strong electromagnetic field can cause operation malfunction.

9) Radiation

This IC is not designed to be radiation-resistant.

10) Handling of IC

When stress is applied to IC because of deflection or bend of board, the characteristics may fluctuate due to piezoelectric (piezo) effect.

11) Inspection on set board

During testing, turn on or off the power before mounting or dismantling the board from the test Jig.

Do not power up the board without waiting for the output capacitors to discharge. The capacitors in the low output impedance terminal can stress the device. Pay attention to the electro static voltages during IC handling, transportation, and storage.

12) Output capacitor

When VCC terminal is shorted to VEE (GND) potential and an electric charge has accumulated on the external capacitor, connected to output terminal, accumulated charge may be discharged VCC terminal via the parasitic element within the circuit or terminal protection element. The element in the circuit may be damaged (thermal destruction). When using this IC for an application circuit where there is oscillation, output capacitor load does not occur, as when using this IC as a voltage comparator. Set the capacitor connected to output terminal below 0.1[μF] in order to prevent damage to IC.

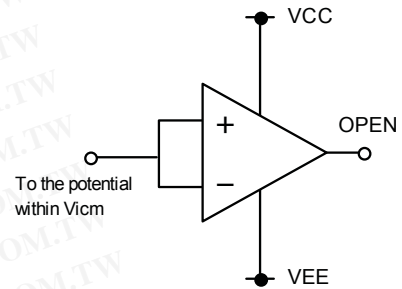
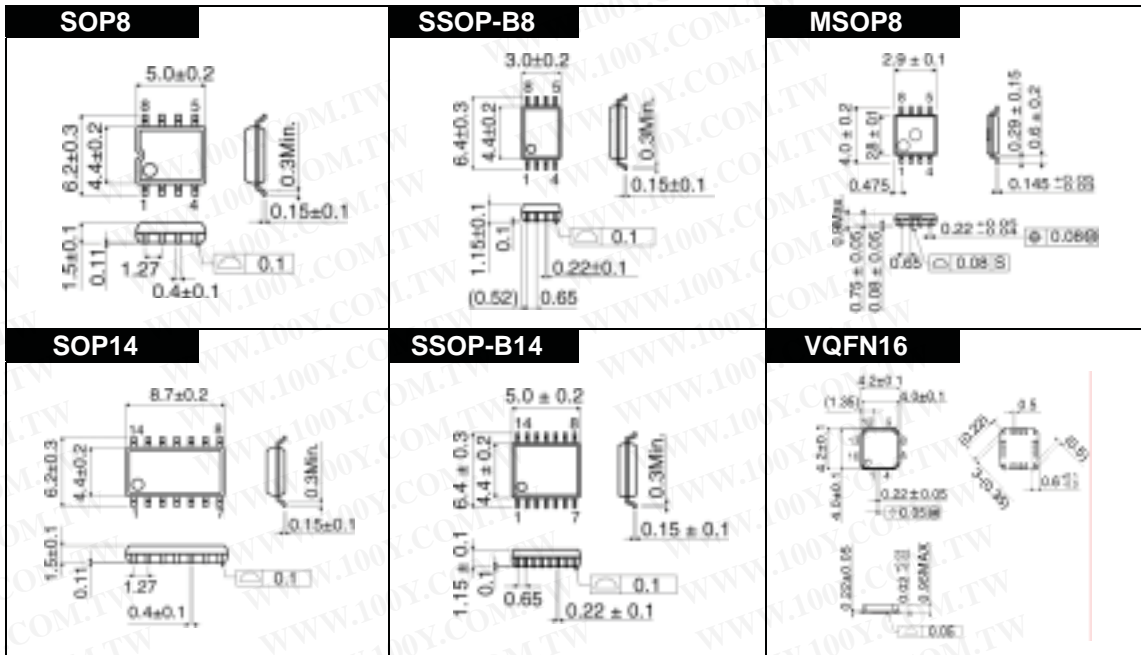

Fig.1 Example of processing unused circuit

勝特力材料 886-3-5753170
勝特力电子(上海) 86-21-34970699
勝特力电子(深圳) 86-755-83298787
[Http://www.100y.com.tw](http://www.100y.com.tw)

● Tape and Reel in formation



● Model number construction

- Specify the product by the model number when placing an order.
- Make sure of the combinations of items.
- Start with the leftmost space without leaving any empty space between characters.



ROHM product name

- BA10393
- BA10339
- BA2903
- BA2901

Package type

- F : SOP8/SOP14
- FV : SSOP-B8/SSOP-B14
- FVM: MSOP8
- KN : VQFN16

E2 Embossed tape on reel with pin 1 near far when pulled out
TR Embossed tape on reel with pin 1 near far when pulled out

Tape and Reel in formation

Package	Packing specification name	Quantity	Embossed carrier tape
SOP8/ SSOP-B8/ SOP14/ SSOP-B14	E2	2500	
MSOP8	TR	3000	
VQFN16	E2	2500	

勝特力材料 886-3-5753170
勝特力电子(上海) 86-21-34970699
勝特力电子(深圳) 86-755-83298787
[Http://www.100y.com.tw](http://www.100y.com.tw)

Appendix

Notes

- No technical content pages of this document may be reproduced in any form or transmitted by any means without prior permission of ROHM CO.,LTD.
- The contents described herein are subject to change without notice. The specifications for the product described in this document are for reference only. Upon actual use, therefore, please request that specifications to be separately delivered.
- Application circuit diagrams and circuit constants contained herein are shown as examples of standard use and operation. Please pay careful attention to the peripheral conditions when designing circuits and deciding upon circuit constants in the set.
- Any data, including, but not limited to application circuit diagrams information, described herein are intended only as illustrations of such devices and not as the specifications for such devices. ROHM CO.,LTD. disclaims any warranty that any use of such devices shall be free from infringement of any third party's intellectual property rights or other proprietary rights, and further, assumes no liability of whatsoever nature in the event of any such infringement, or arising from or connected with or related to the use of such devices.
- Upon the sale of any such devices, other than for buyer's right to use such devices itself, resell or otherwise dispose of the same, no express or implied right or license to practice or commercially exploit any intellectual property rights or other proprietary rights owned or controlled by
- ROHM CO., LTD. is granted to any such buyer.
- Products listed in this document are no antiradiation design.

The products listed in this document are designed to be used with ordinary electronic equipment or devices (such as audio visual equipment, office-automation equipment, communications devices, electrical appliances and electronic toys).

Should you intend to use these products with equipment or devices which require an extremely high level of reliability and the malfunction of which would directly endanger human life (such as medical instruments, transportation equipment, aerospace machinery, nuclear-reactor controllers, fuel controllers and other safety devices), please be sure to consult with our sales representative in advance.

It is our top priority to supply products with the utmost quality and reliability. However, there is always a chance of failure due to unexpected factors. Therefore, please take into account the derating characteristics and allow for sufficient safety features, such as extra margin, anti-flammability, and fail-safe measures when designing in order to prevent possible accidents that may result in bodily harm or fire caused by component failure. ROHM cannot be held responsible for any damages arising from the use of the products under conditions out of the range of the specifications or due to non-compliance with the NOTES specified in this catalog.

Thank you for your accessing to ROHM product informations.

More detail product informations and catalogs are available, please contact your nearest sales office.

ROHM Customer Support System

THE AMERICAS / EUROPE / ASIA / JAPAN

www.rohm.com

Contact us : webmaster@rohm.co.jp