

# 6V/330mW single-channel power amplifier

## BA546

The BA546 is a monolithic power amplifier designed for use in portable radios, tape recorders and interphones. With a 6V power supply, it has a rated output of 330mW into an 8  $\Omega$  load (THD = 10%), and a maximum output of 550mW. It comes in a compact 9-pin SIP package with no heatsink fins.

### ● Applications

Portable radios, cassette recorders, and interphones.

### ● Features

- 1) High output. POUT = 330mW ( $V_{CC} = 6V$  and an 8  $\Omega$  load (THD = 10%). See Fig. 2.
- 2) Good low voltage characteristics. Begins operating at less than 2V (see Fig. 1).
- 3) 9-pin SIP package; around the same size as a pre-amplifier.
- 4) Pin compatible with the Rohm BA526 and BA527 power ICs. Choose to suit your application.
- 5) Low current consumption (4.8mA typ.).

### ● Block diagram

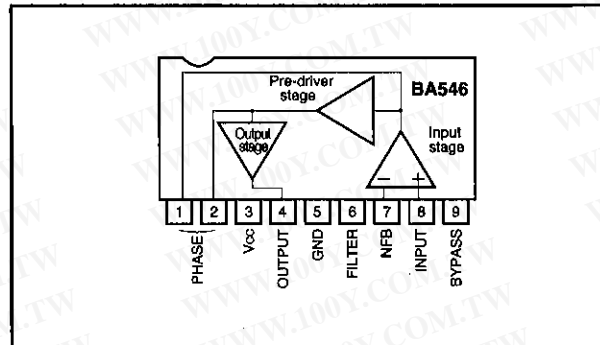

勝特力材料 886-3-5753170  
 勝特力电子(上海) 86-21-34970699  
 勝特力电子(深圳) 86-755-83298787  
[Http://www.100y.com.tw](http://www.100y.com.tw)

● Internal circuit diagram

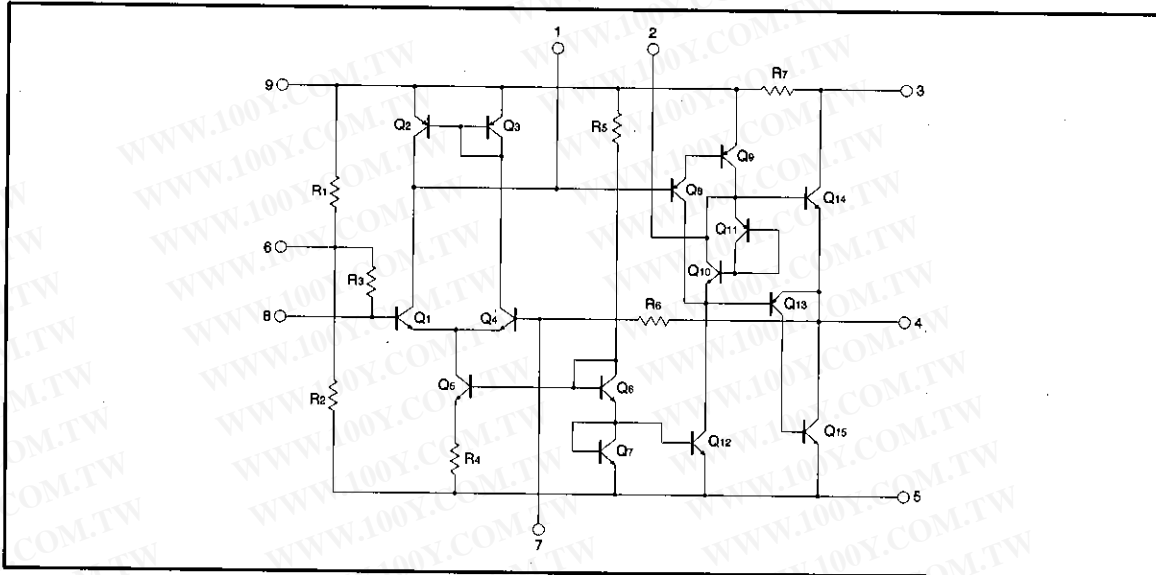

● Absolute maximum ratings (Ta = 25°C)

Parameter	Symbol	Limits	Unit
Supply voltage	V <sub>CC</sub>	12	V
Power dissipation	P <sub>d</sub>	950*	mW
Operating temperature	T <sub>opr</sub>	-30~75	°C
Storage temperature	T <sub>stg</sub>	-40~125	°C

\* Reduced by 9.5mW for each increase in Ta of 1°C over 25°C.

● Electrical characteristics (unless otherwise specified Ta = 25°C, V<sub>CC</sub> = 6V, R<sub>L</sub> = 8 Ω and f = 1kHz)

Parameter	Symbol	Min.	Typ.	Max.	Unit	Conditions	Measurement Circuit
Quiescent circuit current	I <sub>Q</sub>	—	4.8	7	mA	V <sub>IN</sub> =0V <sub>rms</sub>	Fig.10
Closed-circuit voltage gain	G <sub>VC</sub>	47	50	53	dB	R <sub>NF</sub> =68Ω	Fig.10
Rated output	P <sub>OUT</sub>	250	330	—	mW	THD=10%	Fig.10
Total harmonic distortion	THD	—	1.1	2.5	%	P <sub>O</sub> =100mW	Fig.10
Output noise voltage	V <sub>NO</sub>	—	1.0	2.5	mV <sub>rms</sub>	R <sub>g</sub> =10kΩ	Fig.10
Input resistance	R <sub>IN</sub>	—	25	—	kΩ	—	Fig.10

Power amplifiers

Low-frequency amplifiers

● Electrical characteristics curves

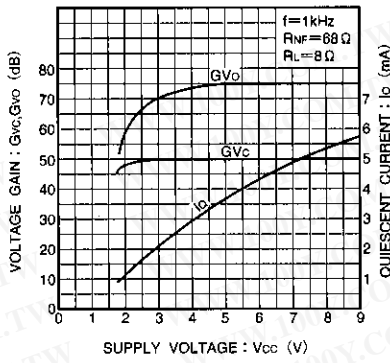

Fig. 1 Quiescent current and voltage gain vs. supply voltage

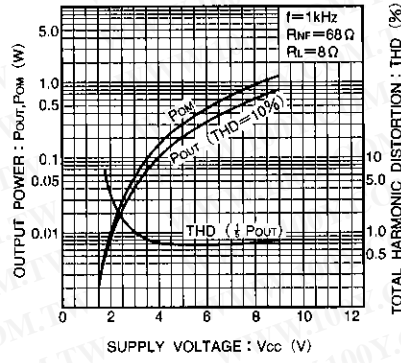

Fig. 2 Rated and max. output power and total harmonic distortion vs. supply voltage

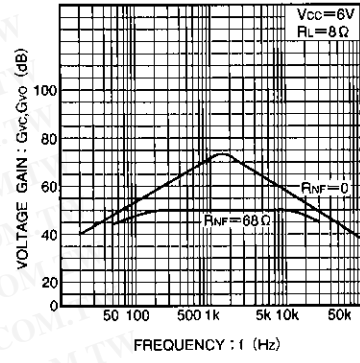

Fig. 3 Voltage gain vs. frequency

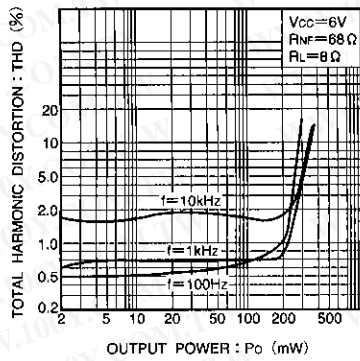

Fig. 4 Total harmonic distortion vs. output power

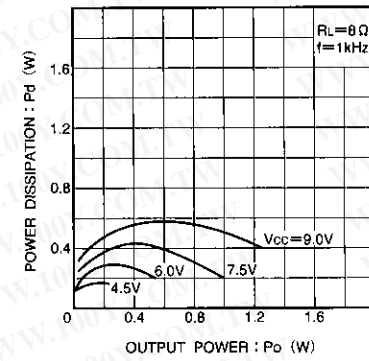

Fig. 5 Power dissipation vs. output power

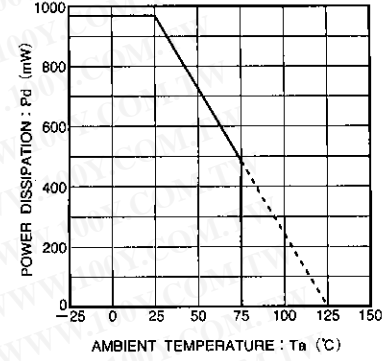

Fig. 6 Power dissipation vs. ambient temperature

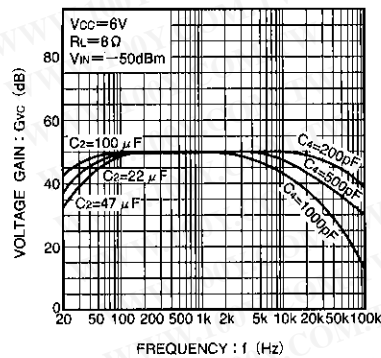

Fig. 7 Voltage gain vs. frequency

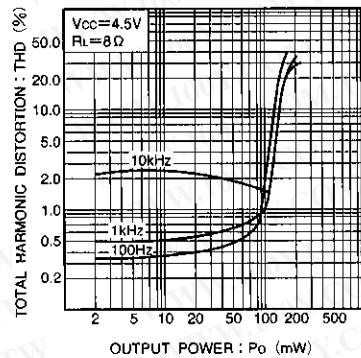

Fig. 8 Total harmonic distortion vs. output power

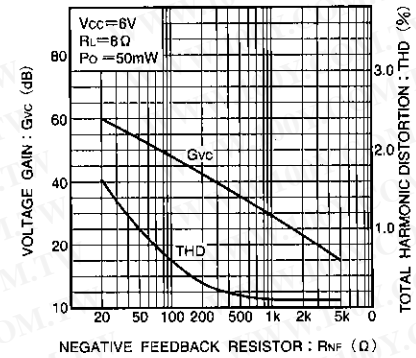

Fig. 9 Voltage gain and total harmonic distortion vs. feedback resistance

● Measurement circuit

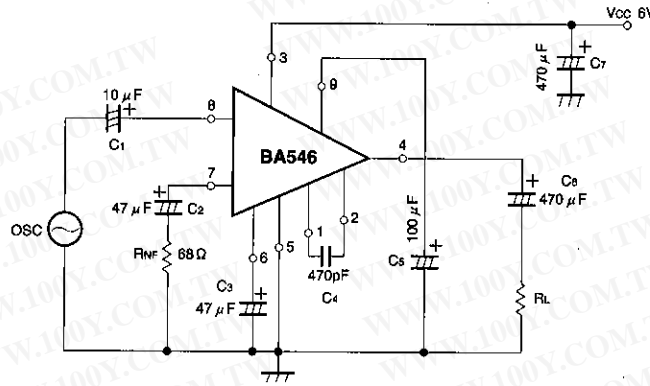

Fig. 10

● External components (see Fig. 10)

C<sub>1</sub> : input coupling capacitor

The recommended value is 10 µF. This capacitor and R<sub>IN</sub> determine the bass cutoff frequency f<sub>LC1</sub> for the input stage according to the following formula :

$$f_{LC1} = \frac{1}{2\pi C_1 R_{IN}} \text{ [Hz]}$$

If the capacitance value of C<sub>1</sub> is too small, the signal source reactance will increase, and cause the noise to increase and f<sub>LC1</sub> will become higher. Conversely, if it is too large, the startup time after power is applied will be longer, and if the potentiometer is adjusted while the capacitor is charging, the charging current will flow through the slider current, and cause noise.

C<sub>2</sub> : DC cutoff resistor for the feedback circuit

The recommended value is 47 µF. This capacitor and R<sub>NF</sub> determine feedback circuit bass cutoff frequency f<sub>LC2</sub>. f<sub>LC2</sub> is given by the following formula :

$$f_{LC2} = \frac{1}{2\pi C_2 R_{NF}} \text{ [Hz]}$$

Fig. 7 illustrates how changing C<sub>2</sub> varies the bass characteristics.

C<sub>3</sub> : ripple filter capacitor

The recommended value is 47 µF.

C<sub>4</sub> : Phase compensation capacitor

This capacitor determines the treble cutoff frequency f<sub>HC</sub>. f<sub>HC</sub> is given by the following formula :

$$f_{HC} = \frac{4000}{C_4 \text{ [pF]}} \text{ [kHz]}$$

(however, G<sub>VC</sub> = 50dB)

If G<sub>VC</sub> is not 50dB, f<sub>HC</sub> doubles for each decrease in G<sub>VC</sub> of 6dB.

Fig. 7 illustrates how changing C<sub>4</sub> varies the treble characteristics.

C<sub>5</sub> : ripple filter and pre-driver bypass capacitor

The recommended value is 100 µF. If this capacitor is made too small, the ripple rejection and power output will deteriorate.

C<sub>6</sub> : Output coupling capacitor

The recommended value is 470 µF.

C<sub>7</sub> : Power supply filter capacitor

Determine based on the amount of power supply ripple and the regulation.

●Circuit construction (See Fig. 11)

(1) Voltage amplification stage

This circuit is comprised of a differential amplifier (Q<sub>1</sub> and Q<sub>4</sub>), a constant current source (Q<sub>5</sub>), and an active load (Q<sub>2</sub> and Q<sub>3</sub>). This active load is the input to the pre-driver (via Q<sub>6</sub> and Q<sub>9</sub>).

(2) Pre-driver

The pre-driver is an earthed-emitter amplifier with transistors Q<sub>8</sub> and Q<sub>9</sub> forming a Darlington PNP transistor. The Q<sub>9</sub> collector load is the input impedance looking from the base of Q<sub>14</sub> and the constant-current load due to Q<sub>12</sub>.

(3) Idling loop

The idling loop is the Q<sub>13</sub>, Q<sub>10</sub>, Q<sub>11</sub> and Q<sub>14</sub> loop. The V<sub>BE</sub> of Q<sub>13</sub> is subtracted from the V<sub>F</sub> of Q<sub>10</sub> and Q<sub>11</sub> and is biased by Q<sub>14</sub>.

(4) Power stage

The power stage is a quasi-complementary circuit made up of a Darlington PNP transistor (Q<sub>13</sub> and Q<sub>15</sub>), and an NPN transistor (Q<sub>14</sub>).

(5) The AC gain is determined by the ratio between R<sub>6</sub> (24k Ω) and R<sub>NF</sub> connected to pin 7. The formula is as follows :

$$G_{VC} \approx 20 \log \frac{24k \Omega}{R_{NF}} \text{ (dB)}$$

Variation of G<sub>VC</sub> and THD with R<sub>NF</sub> is shown in Fig. 9.

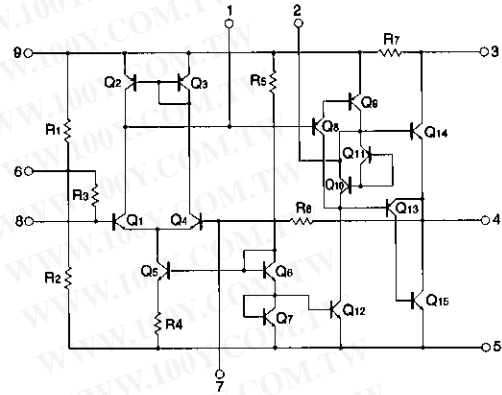

Fig. 11

●Application example

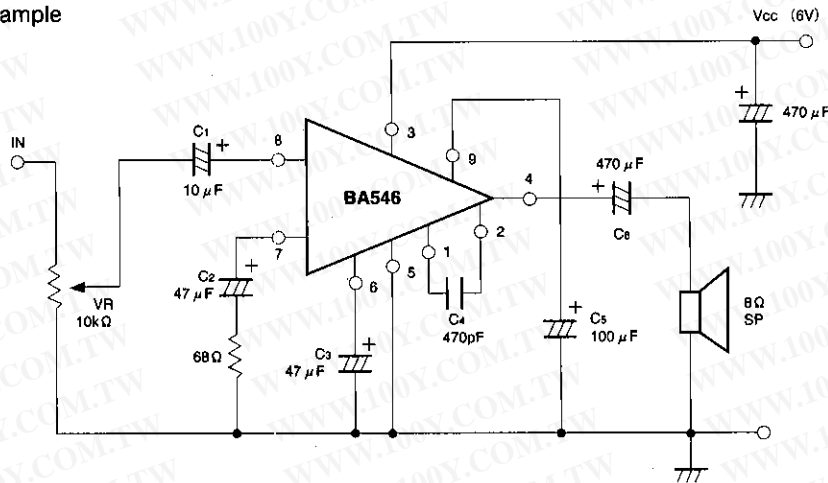
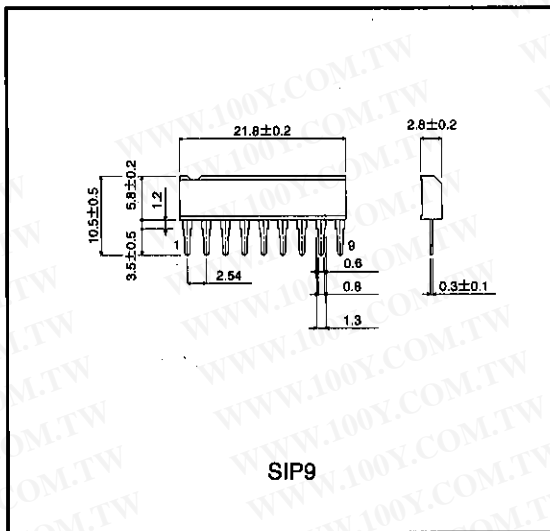

Fig. 12

The BA546 will generally be used as a power amplifier for portable cassette players and similar equipment, and will usually have a preamplifier before it, so insert the volume control between the stages. The gain of the power stage alone is determined by R<sub>NF</sub>. Use Fig. 9 to choose a value for R<sub>NF</sub> that gives the required gain.

When R<sub>NF</sub> is 68 Ω, the standard G<sub>VC</sub> is 50dB. When combining the BA546 with an ALC-equipped preamplifier as the previous stage, the control voltage for the ALC can be taken from pin 4, and the power supply for the preamplifier from pin 9.

● External dimensions (Unit: mm)



勝特力材料 886-3-5753170  
勝特力电子(上海) 86-21-34970699  
勝特力电子(深圳) 86-755-83298787  
[Http://www.100y.com.tw](http://www.100y.com.tw)

Power amplifiers

Low-frequency amplifiers