

ROHM's Selection Operational Amplifier/Comparator Series

High Voltage Operation CMOS

Operational Amplifiers:Input/Output Full Swing

**BD7561G,BD7561SG,BD7541G,BD7541SG,
 BD7562F/FVM,BD7562SF/FVM,BD7542F/FVM,BD7542SF/FVM**

No.09049EBT05

●Description

High voltage operable CMOS Op-Amp BD7561/BD7541 family and BD7562/BD7542 family Integrate one or two independent input-output fullswing Op-amps and phase compensation capacitorson a single chip. Especially, characteristics are wide operating voltage range of +5[V]~+14.5[V](single power supply),low supply current and little input bias current.

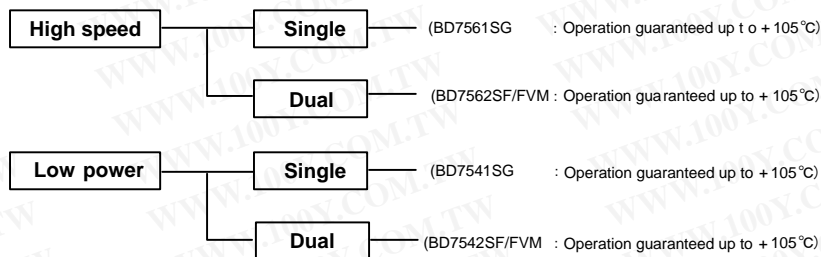

●Features

- 1) Wide operating supply voltage(+5[V]~+14.5[V])
- 2) +5[V]~+14.5[V](single supply)
±2.5[V]~±7.25[V](split supply)
- 3) Input and Output full swing
- 4) Internal phase compensation
- 5) High slew rate (BD7561 family, BD7562 family)
- 6) Low supply current (BD7541 family, BD7542 family)
- 7) High large signal voltage gain
- 8) Internal ESD protection
Human body model (HBM) ±4000[V](Typ.)
- 9) Wide temperature range
-40[°C]~+85[°C] (BD7561G,BD7562 family, BD7541G,BD7542 family)
-40[°C]~+105[°C] (BD7561SG,BD7562S family, BD7541SG,BD7542S family)

●Pin Assignment

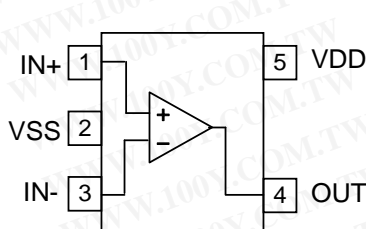

SSOP5

BD7561G
 BD7561SG
 BD7541G
 BD7541SG

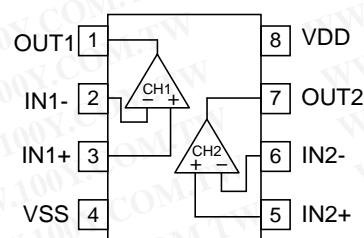

SOP8

MSOP8

BD7562F BD7562FVM
 BD7562SF BD7562SFVM
 BD7542F BD7542FVM
 BD7542SF BD7542SFVM

● Absolute Maximum Ratings (Ta=25°C)

Parameter	Symbol	Rating		Unit
		BD7561G, BD7562 F/FVM BD7541G, BD7542 F/FVM	BD7561SG, BD7562S F/FVM BD7541SG, BD7542S F/FVM	
Supply Voltage	VDD-VSS	+15.5		V
Differential Input Voltage ^(*)	Vid	VDD-VSS		V
Input Common-mode Voltage Range	Vicm	(VSS-0.3)~(VDD+0.3)		V
Operating Temperature	Topr	-40~+85	-40~+105	°C
Storage Temperature	Tstg	-55~+125		°C
Maximum Junction Temperature	Tjmax	+125		°C

Note: Absolute maximum rating item indicates the condition which must not be exceeded.

Application of voltage in excess of absolute maximum rating or use out absolute maximum rated temperature environment may cause deterioration of characteristics.

(*) The voltage difference between inverting input and non-inverting input is the differential input voltage.
Then input terminal voltage is set to more than VSS.

● Electric Characteristics

OBD7561 family (Unless otherwise specified VDD=+12[V], VSS=0[V], Ta=25°C)

Parameter	Symbol	Temperature range	Guaranteed limit			Unit	Condition
			BD7561G, BD7561SG				
			Min.	Typ.	Max.		
Input Offset Voltage ^(*) (^(*))	Vio	25°C	-	1	9	mV	VDD=5~14.5[V], VOUT=VDD/2
		Full range	-	-	10		
Input Offset Current ^(*)	Iio	25°C	-	1	-	pA	-
Input Bias Current ^(*)	Ib	25°C	-	1	-	pA	-
Supply Current ^(*)	IDD	25°C	-	370	550	µA	RL=∞ All Op-Amps AV=0[dB], VDD=5[V], VIN=2.5[V] RL=∞ All Op-Amps AV=0[dB], VDD=12[V], VIN=6.0[V]
		Full range	-	-	600		
		25°C	-	440	650		
		Full range	-	-	700		
High Level Output Voltage	VOH	25°C	VDD-0.1	-	-	V	RL=10[kΩ]
Low Level Output Voltage	VOL	25°C	-	-	VSS+0.1	V	RL=10[kΩ]
Large Single Voltage Gain	AV	25°C	70	95	-	dB	RL=10[kΩ]
Input Common-mode Voltage Range	Vicm	25°C	0	-	12	V	VDD-VSS=12[V]
Common-mode Rejection Ratio	CMRR	25°C	45	60	-	dB	-
Power Supply Rejection Ratio	PSRR	25°C	60	80	-	dB	-
Output Source Current ^(*)	IOH	25°C	3	8	-	mA	VDD-0.4[V]
Output Sink Current ^(*)	IOL	25°C	4	14	-	mA	VSS+0.4[V]
Slew Rate	SR	25°C	-	0.9	-	V/µs	CL=25[pF]
Gain Bandwidth Product	FT	25°C	-	1.0	-	MHz	CL=25[pF], AV=40[dB]
Phase Margin	θ	25°C	-	50°	-	-	CL=25[pF], AV=40[dB]
Total Harmonic Distortion	THD	25°C	-	0.05	-	%	VOUT=1[Vp-p], f=1[kHz]

(*) Absolute value

(*) Under the high temperature environment, consider the power dissipation of IC when selecting the output current.

When the terminal short circuits are continuously output, the output current is reduced to climb to the temperature inside IC.

(*) Full range : BD7561 : Ta=-40°C~+85°C BD7561S : Ta=-40°C~+105°C

OBD7562 family (Unless otherwise specified VDD=+12[V], VSS=0[V], Ta=25[°C])

Parameter	Symbol	Temperature range	Guaranteed limit			Unit	Condition
			BD7562F/FVM BD7562SF/FVM				
			Min.	Typ.	Max.		
Input Offset Voltage ⁽²⁾⁽⁴⁾	Vio	25°C	-	1	9	mV	VDD=5~14.5[V],VOUT=VDD/2
		Full range	-	-	10		
Input Offset Current ⁽²⁾	Iio	25°C	-	1	-	pA	-
Input Bias Current ⁽²⁾	Ib	25°C	-	1	-	pA	-
Supply Current ⁽⁴⁾	IDD	25°C	-	750	1300	µA	RL=∞ All Op-Amps AV=0[dB],VDD=5[V],VIN=2.5[V] RL=∞ All Op-Amps AV=0[dB],VDD=12[V],VIN=6.0[V]
		Full range	-	-	1500		
		25°C	-	900	1400		
		Full range	-	-	1600		
High Level Output Voltage	VOH	25°C	VDD-0.1	-	-	V	RL=10[kΩ]
Low Level Output Voltage	VOL	25°C	-	-	VSS+0.1	V	RL=10[kΩ]
Large Single Voltage Gain	AV	25°C	70	95	-	dB	RL=10[kΩ]
Input Common-mode Voltage Range	Vicm	25°C	0	-	12	V	VDD-VSS=12[V]
Common-mode Rejection Ratio	CMRR	25°C	45	60	-	dB	-
Power Supply Rejection Ratio	PSRR	25°C	60	80	-	dB	-
Output Source Current ⁽³⁾	IOH	25°C	3	8	-	mA	VDD-0.4[V]
Output Sink Current ⁽³⁾	IOL	25°C	4	14	-	mA	VSS+0.4[V]
Slew Rate	SR	25°C	-	0.9	-	V/µs	CL=25[pF]
Gain Bandwidth Product	FT	25°C	-	1.0	-	MHz	CL=25[pF], AV=40[dB]
Phase Margin	θ	25°C	-	50°	-	-	CL=25[pF], AV=40[dB]
Total Harmonic Distortion	THD	25°C	-	0.05	-	%	VOUT=1[Vp-p],f=1[kHz]

(2) Absolute value

(3) Under the high temperature environment, consider the power dissipation of IC when selecting the output current.

When the terminal short circuits are continuously output, the output current is reduced to climb to the temperature inside IC.

(4) Full range : BD7562 : Ta=-40[°C]~+85[°C] BD7562S : Ta=-40[°C]~+105[°C]

OBD7541 family (Unless otherwise specified VDD=+12[V], VSS=0[V], Ta=25[°C])

Parameter	Symbol	Temperature range	Guaranteed limit			Unit	Condition
			BD7541G,BD7541SG				
			Min.	Typ.	Max.		
Input Offset Voltage ⁽⁵⁾⁽⁷⁾	Vio	25°C	-	1	9	mV	VDD=5~14.5[V],VOUT=VDD/2
		Full range	-	-	10		
Input Offset Current ⁽⁵⁾	Iio	25°C	-	1	-	pA	-
Input Bias Current ⁽⁵⁾	Ib	25°C	-	1	-	pA	-
Supply Current ⁽⁷⁾	IDD	25°C	-	170	300	µA	RL=∞ All Op-Amps AV=0[dB],VDD=5[V],VIN=2.5[V] RL=∞ All Op-Amps AV=0[dB],VDD=12[V],VIN=6.0[V]
		Full range	-	-	400		
		25°C	-	180	320		
		Full range	-	-	420		
High Level Output Voltage	VOH	25°C	VDD-0.1	-	-	V	RL=10[kΩ]
Low Level Output Voltage	VOL	25°C	-	-	VSS+0.1	V	RL=10[kΩ]
Large Single Voltage Gain	AV	25°C	70	95	-	dB	RL=10[kΩ]
Input Common-mode Voltage Range	Vicm	25°C	0	-	12	V	VDD-VSS=12[V]
Common-mode Rejection Ratio	CMRR	25°C	45	60	-	dB	-
Power Supply Rejection Ratio	PSRR	25°C	60	80	-	dB	-
Output Source Current ⁽⁶⁾	IOH	25°C	2	4	-	mA	VDD-0.4[V]
Output Sink Current ⁽⁶⁾	IOL	25°C	3	7	-	mA	VSS+0.4[V]
Slew Rate	SR	25°C	-	0.3	-	V/µs	CL=25[pF]
Gain Bandwidth Product	FT	25°C	-	0.6	-	MHz	CL=25[pF], AV=40[dB]
Phase Margin	θ	25°C	-	50°	-	-	CL=25[pF], AV=40[dB]
Total Harmonic Distortion	THD	25°C	-	1	9	%	VOUT=1[Vp-p],f=1[kHz]

(5) Absolute value

(6) Under the high temperature environment, consider the power dissipation of IC when selecting the output current.

When the terminal short circuits are continuously output, the output current is reduced to climb to the temperature inside IC.

(7) Full range : BD7541 : Ta=-40[°C]~+85[°C] BD7541S : Ta=-40[°C]~+105[°C]

OBD7542 family (Unless otherwise specified VDD=+12[V], VSS=0[V], Ta=25[°C])

Parameter	Symbol	Temperature range	Guaranteed limit			Unit	Condition
			BD7542 F/FVM BD7542S F/FVM				
			Min.	Typ.	Max.		
Input Offset Voltage ⁽⁵⁾⁽⁷⁾	Vio	25°C	-	1	9	mV	VDD=5~14.5[V],VOUT=VDD/2
		Full range	-	-	10		
Input Offset Current ⁽⁵⁾	Iio	25°C	-	1	-	pA	-
Input Bias Current ⁽⁵⁾	Ib	25°C	-	1	-	pA	-
Supply Current ⁽⁷⁾	IDD	25°C	-	340	650	μA	RL=∞ All Op-Amps AV=0[dB],VDD=5[V],VIN=2.5[V] RL=∞ All Op-Amps AV=0[dB],VDD=12[V],VIN=6.0[V]
		Full range	-	-	850		
		25°C	-	400	780		
		Full range	-	-	900		
High Level Output Voltage	VOH	25°C	VDD-0.1	-	-	V	RL=10[kΩ]
Low Level Output Voltage	VOL	25°C	-	-	VSS+0.1	V	RL=10[kΩ]
Large Single Voltage Gain	AV	25°C	70	95	-	dB	RL=10[kΩ]
Input Common-mode Voltage Range	Vicm	25°C	0	-	12	V	VDD-VSS=12[V]
Common-mode Rejection Ratio	CMRR	25°C	45	60	-	dB	-
Power Supply Rejection Ratio	PSRR	25°C	60	80	-	dB	-
Output Source Current ⁽⁶⁾	IOH	25°C	2	4	-	mA	VDD-0.4[V]
Output Sink Current ⁽⁶⁾	IOL	25°C	3	7	-	mA	VSS+0.4[V]
Slew Rate	SR	25°C	-	0.3	-	V/μs	CL=25[pF]
Gain Bandwidth Product	FT	25°C	-	0.6	-	MHz	CL=25[pF], AV=40[dB]
Phase Margin	θ	25°C	-	50°	-	-	CL=25[pF], AV=40[dB]
Total Harmonic Distortion	THD	25°C	-	0.05	-	%	VOUT=1[Vp-p],f=1[kHz]

(*5) Absolute value

(*6) Under the high temperature environment, consider the power dissipation of IC when selecting the output current.

When the terminal short circuits are continuously output, the output current is reduced to climb to the temperature inside IC.

(*7) Full range : BD7542 : Ta=-40[°C]~+85[°C] BD7542S : Ta=-40[°C]~+105[°C]

● Example of electrical characteristics

OBD7561 family

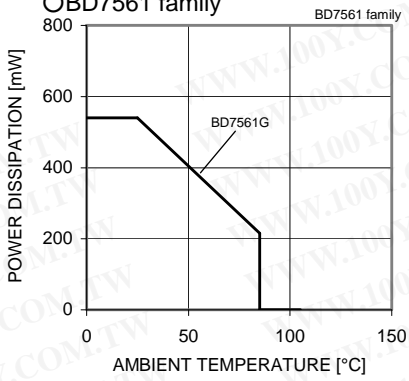

Fig. 1 Derating Curve

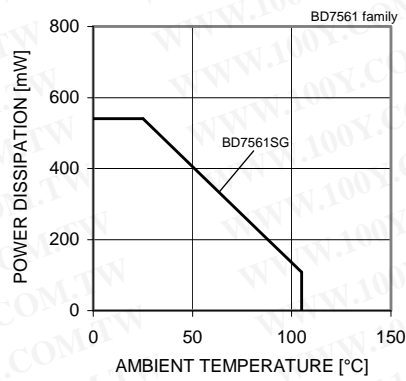

Fig. 2 Derating Curve

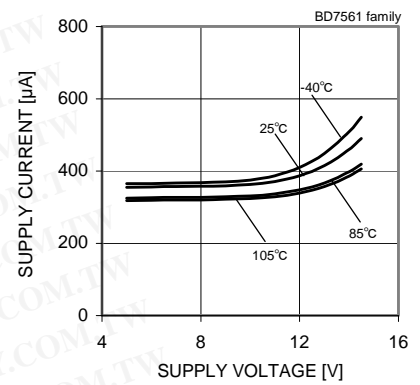

Fig. 3 Supply Current - Supply Voltage

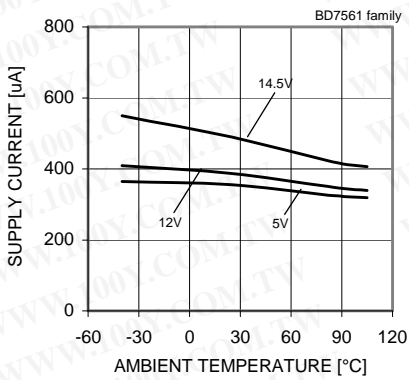

Fig. 4 Supply Current - Ambient Temperature

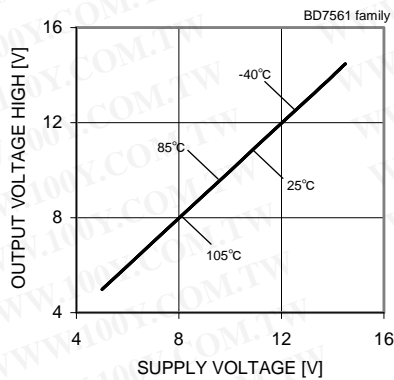

Fig. 5 Output Voltage High - Supply Voltage (RL=10[kΩ])

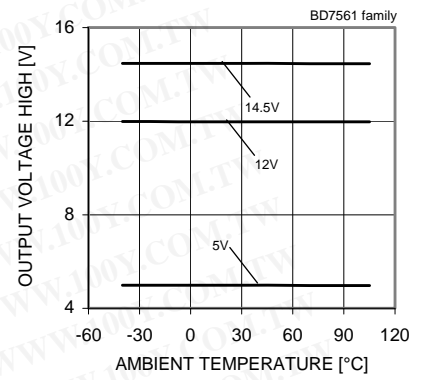

Fig. 6 Output Voltage High - Ambient Temperature (RL=10[kΩ])

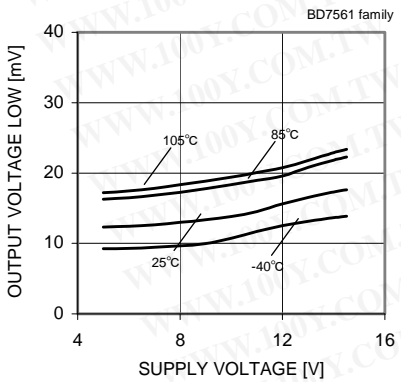

Fig. 7 Output Voltage Low - Supply Voltage (RL=10[kΩ])

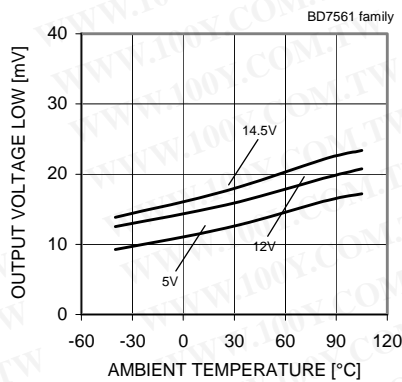

Fig. 8 Output Voltage Low - Ambient Temperature (RL=10[kΩ])

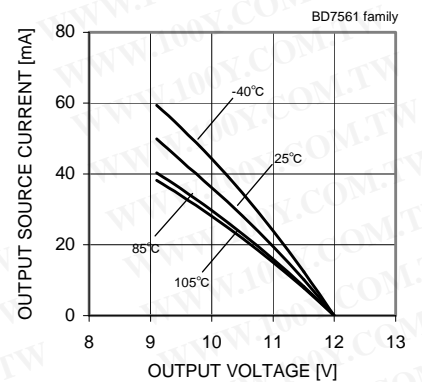

Fig. 9 Output Source Current - Output Voltage (VDD=12[V])

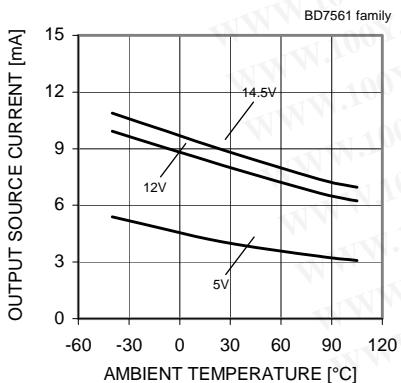

Fig. 10 Output Source Current - Ambient Temperature (VOUT=VDD-0.4[V])

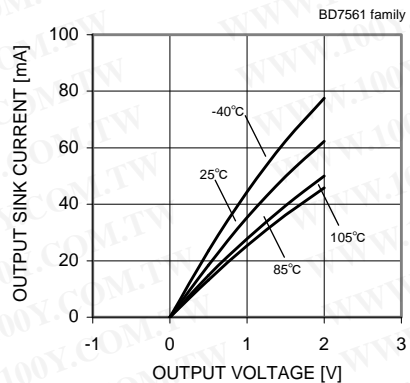

Fig. 11 Output Sink Current - Output Voltage (VDD=12[V])

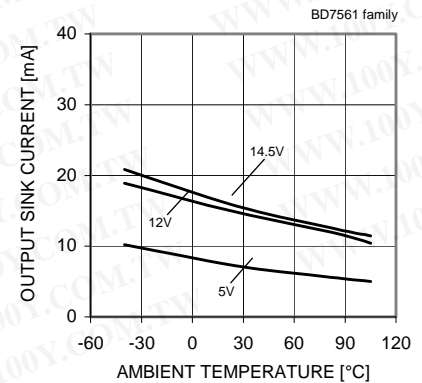

Fig. 12 Output Sink Current - Ambient Temperature (VOUT=VDD-11.6[V])

(*) The above data is ability value of sample, it is not guaranteed. BD7561 : -40[°C]~+85[°C] BD7561S : -40[°C]~+105[°C]

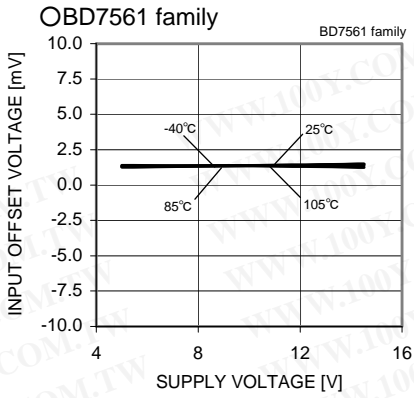

Fig. 13
Input Offset Voltage – Supply Voltage
($V_{icm}=V_{DD}$, $V_{OUT}=V_{DD}/2$)

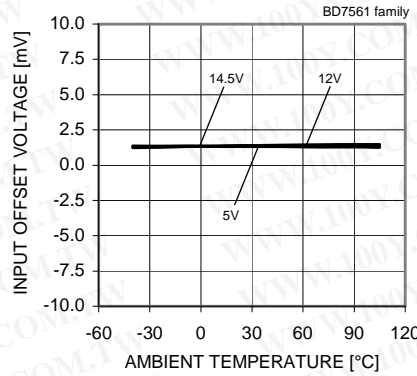

Fig. 14
Input Offset Voltage – Ambient Temperature
($V_{icm}=V_{DD}$, $V_{OUT}=V_{DD}/2$)

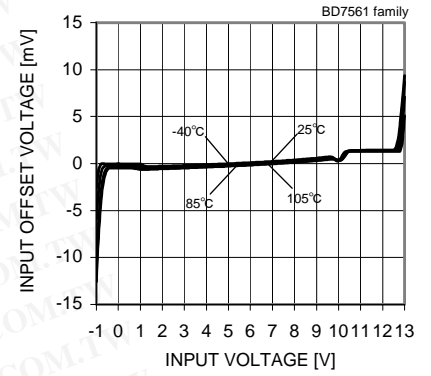

Fig. 15
Input Offset Voltage – Input Voltage
($V_{DD}=12[V]$)

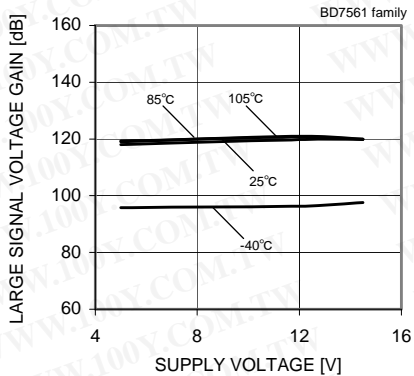

Fig. 16
Large Signal Voltage Gain
– Supply Voltage

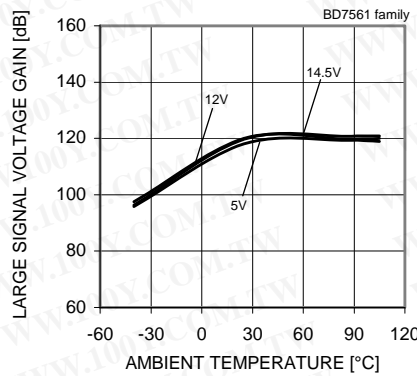

Fig. 17
Large Signal Voltage Gain
– Ambient Temperature

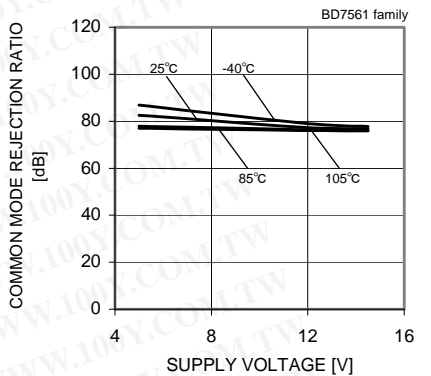

Fig. 18
Common Mode Rejection Ratio
– Supply Voltage
($V_{DD}=12[V]$)

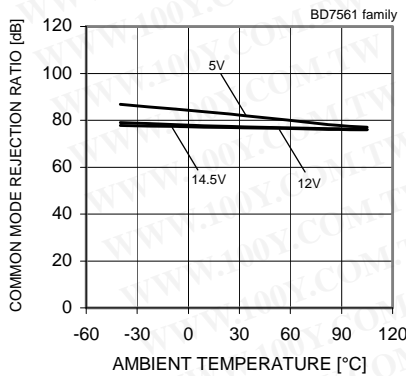

Fig. 19
Common Mode Rejection Ratio
– Ambient Temperature
($V_{DD}=12[V]$)

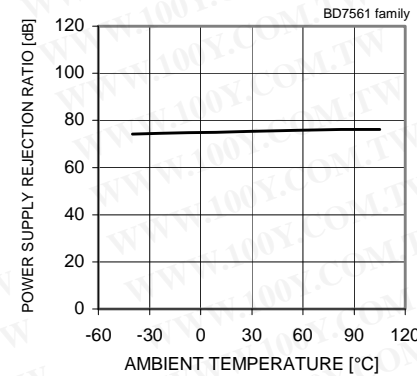

Fig. 20
Power Supply Rejection Ratio
– Ambient Temperature

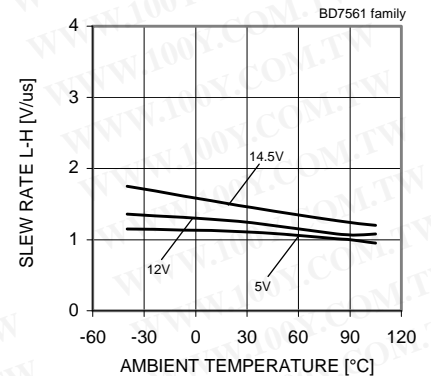

Fig. 21
Slew Rate L-H – Ambient Temperature

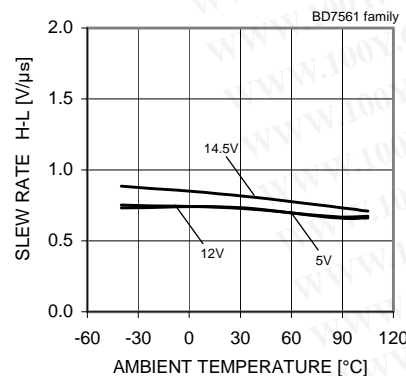

Fig. 22
Slew Rate H-L – Ambient
Temperature

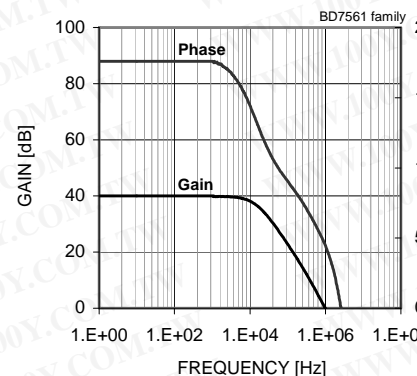

Fig. 23
Gain - Frequency

(*)The above data is ability value of sample, it is not guaranteed. BD7561 : -40[°C]~+85[°C] BD7561S : -40[°C]~+105[°C]

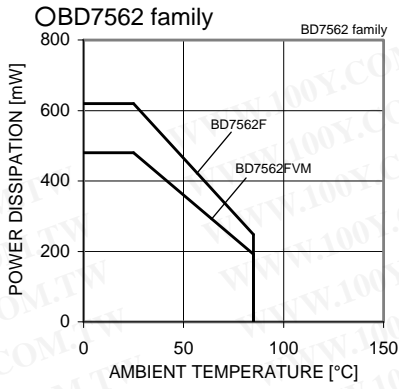

Fig. 24 Derating Curve

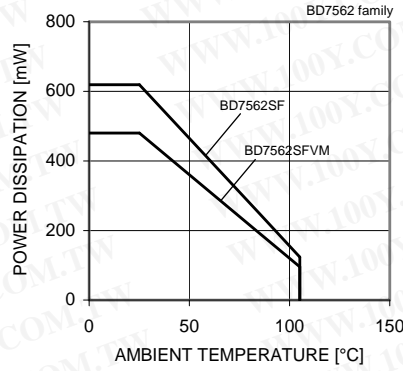

Fig. 25 Derating Curve

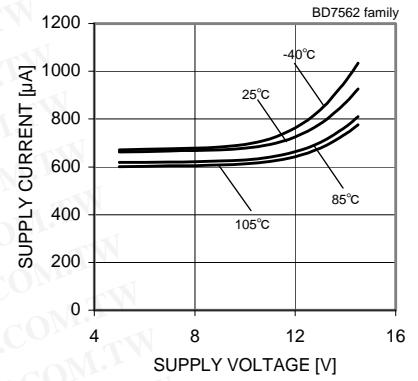

Fig. 26 Supply Current - Supply Voltage

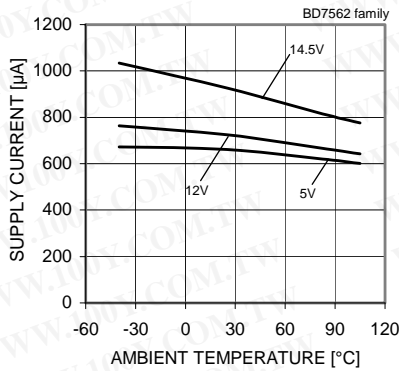

Fig. 27 Supply Current - Ambient Temperature

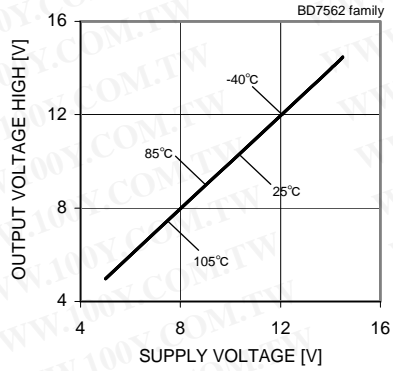

Fig. 28 Output Voltage High - Supply Voltage (RL=10[kΩ])

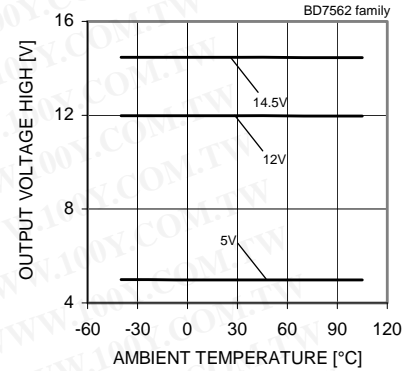

Fig. 29 Output Voltage High - Ambient Temperature (RL=10[kΩ])

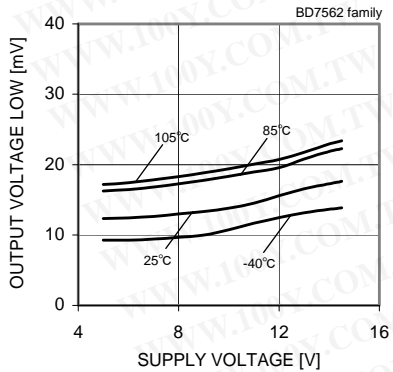

Fig. 30 Output Voltage Low - Supply Voltage (RL=10[kΩ])

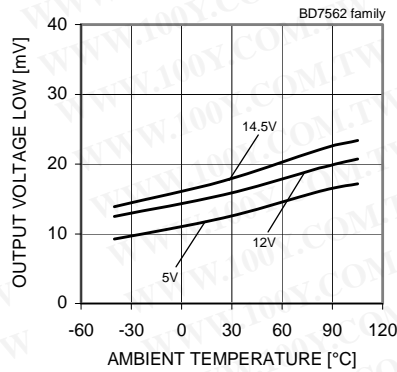

Fig. 31 Output Voltage Low - Ambient Temperature (RL=10[kΩ])

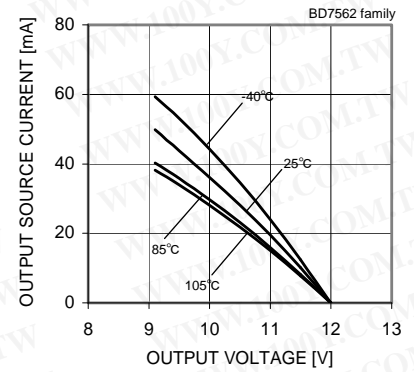

Fig. 32 Output Source Current - Output Voltage (VDD=12[V])

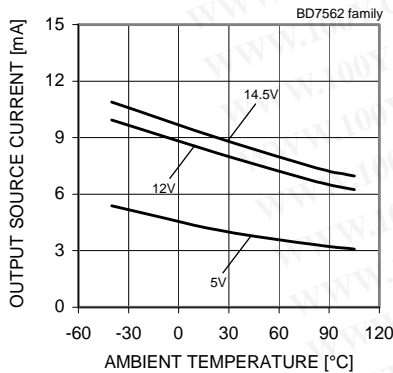

Fig. 33 Output Source Current - Ambient Temperature

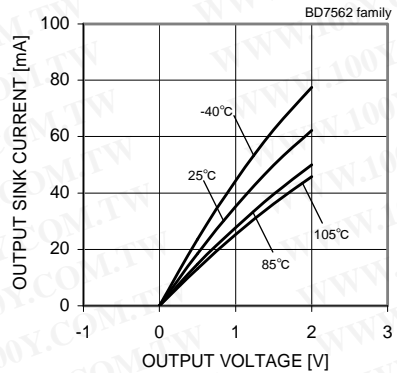

Fig. 34 Output Sink Current - Output Voltage (VDD=12[V])

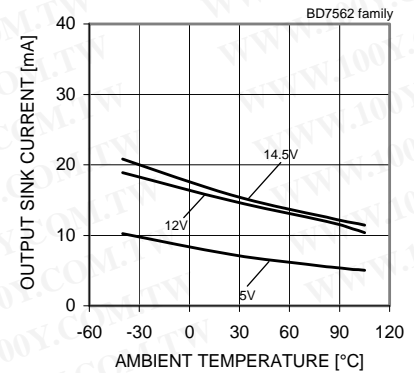

Fig. 35 Output Sink Current - Ambient Temperature (VOUT=VDD-11.6[V])

(*)The above data is ability value of sample, it is not guaranteed. BD7562 : -40[°C]~+85[°C] BD7562S : -40[°C]~+105[°C]

OBD7562 family

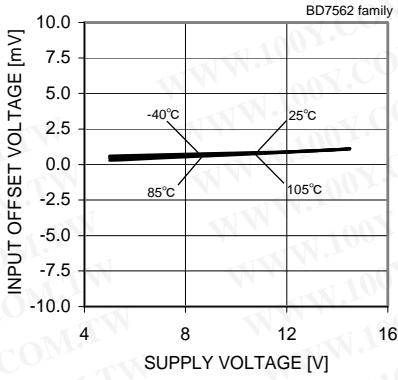

Fig. 36

Input Offset Voltage – Supply Voltage
($V_{icm}=V_{DD}$, $V_{OUT}=V_{DD}/2$)

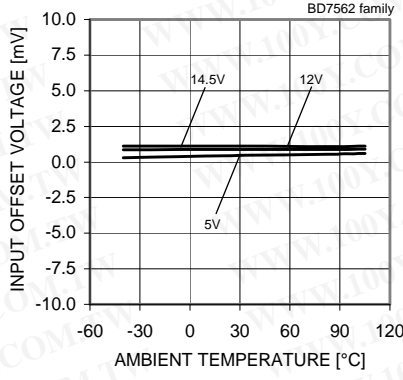

Fig. 37

Input Offset Voltage – Ambient Temperature
($V_{icm}=V_{DD}$, $V_{OUT}=V_{DD}/2$)

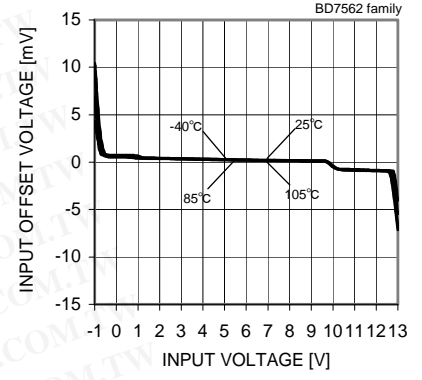

Fig. 38

Input Offset Voltage – Input Voltage
($V_{DD}=12[V]$)

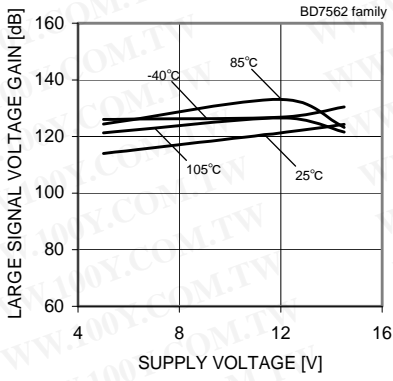

Fig. 39

Large Signal Voltage Gain
– Supply Voltage

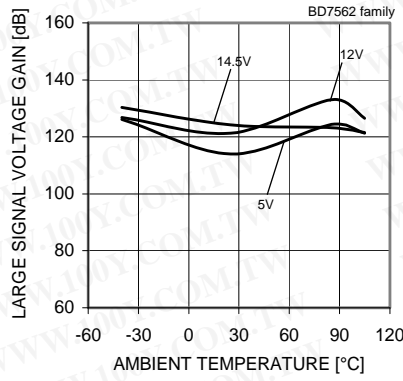

Fig. 40

Large Signal Voltage Gain
– Ambient Temperature

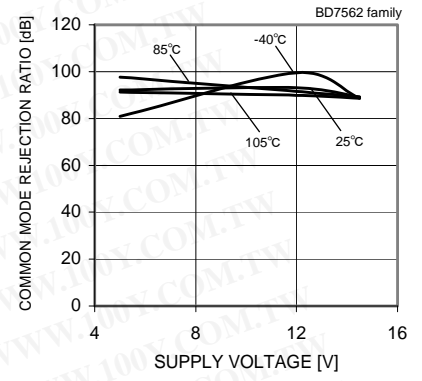

Fig. 41

Common Mode Rejection Ratio
– Supply Voltage
($V_{DD}=12[V]$)

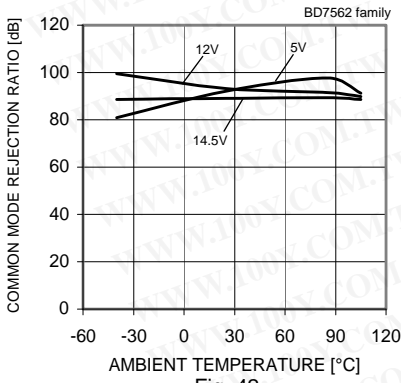

Fig. 42

Common Mode Rejection Ratio
– Ambient Temperature
($V_{DD}=12[V]$)

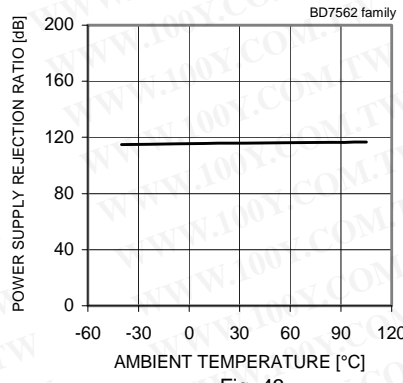

Fig. 43

Power Supply Rejection Ratio
– Ambient Temperature

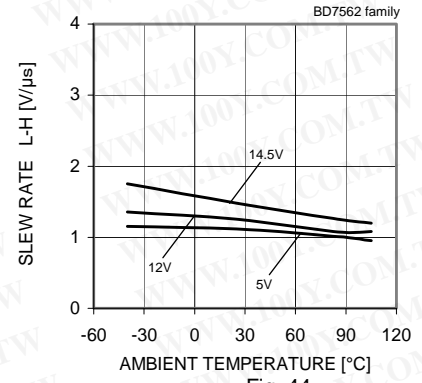

Fig. 44

Slew Rate L-H – Ambient Temperature

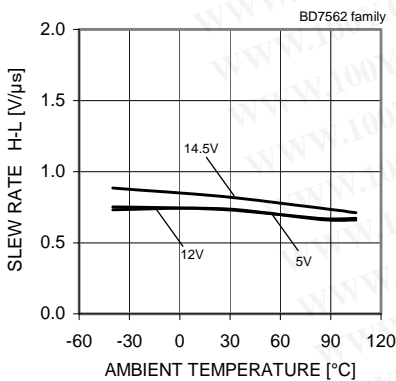

Fig. 45

Slew Rate H-L – Ambient
Temperature

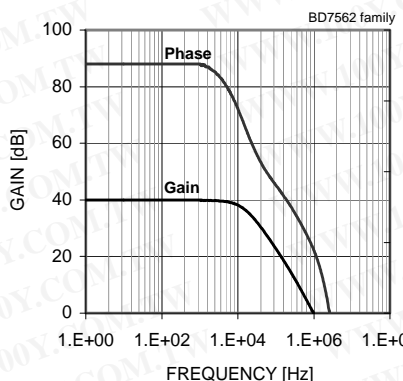

Fig. 46

Gain - Frequency

(*)The above data is ability value of sample, it is not guaranteed. BD7562 : -40[°C]~+85[°C] BD7562S : -40[°C]~+105[°C]

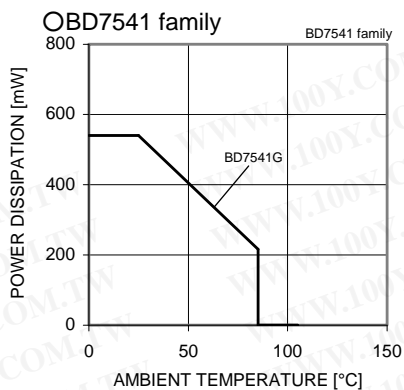

Fig. 47
Derating Curve

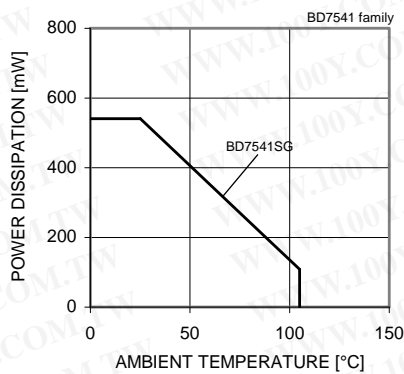

Fig. 48
Derating Curve

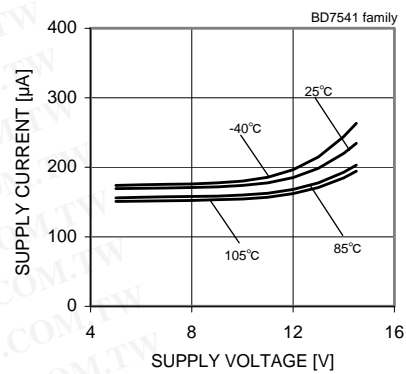

Fig. 49
Supply Current – Supply Voltage

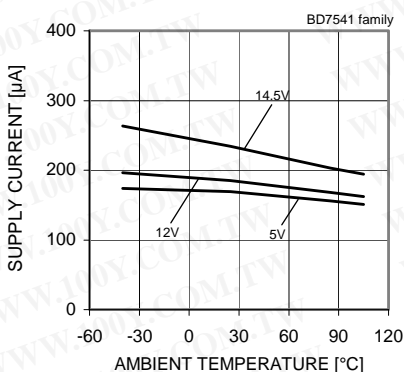

Fig. 50
Supply Current – Ambient Temperature

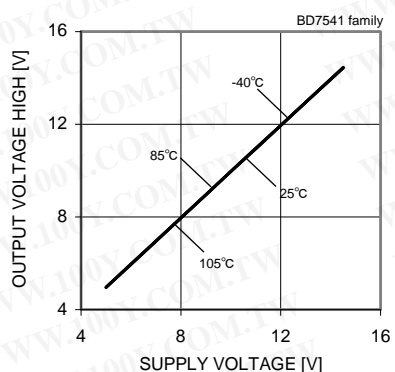

Fig. 51
Output Voltage High – Supply Voltage
($R_L=10[k\Omega]$)

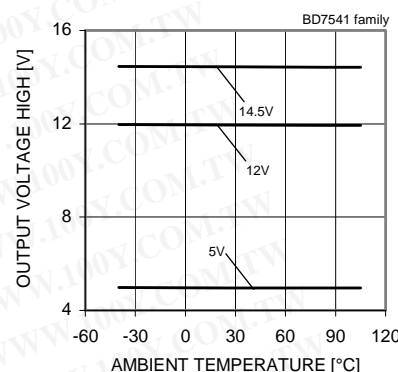

Fig. 52
Output Voltage High – Ambient Temperature
($R_L=10[k\Omega]$)

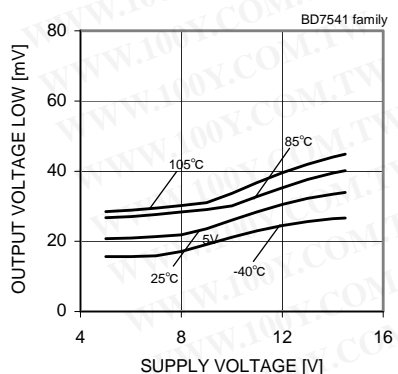

Fig. 53
Output Voltage Low – Supply Voltage
($R_L=10[k\Omega]$)

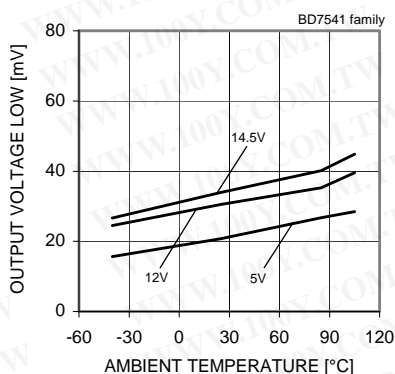

Fig. 54
Output Voltage Low – Ambient Temperature
($R_L=10[k\Omega]$)

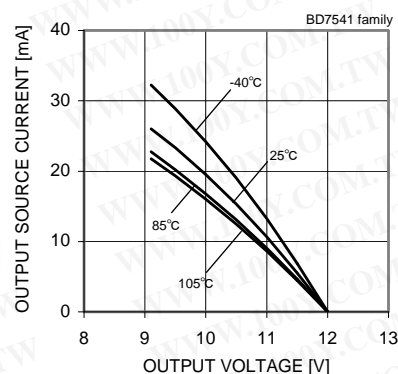

Fig. 55
Output Source Current – Output Voltage
($V_{DD}=12[V]$)

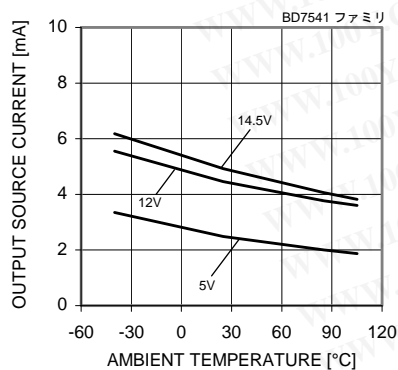

Fig. 56
Output Source Current – Ambient
Temperature

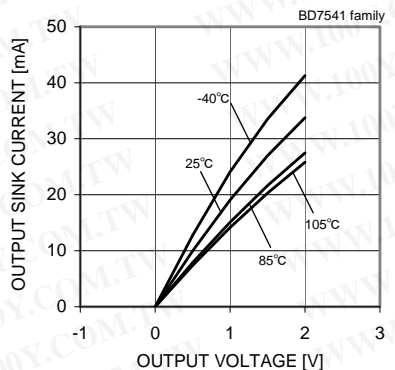

Fig. 57
Output Sink Current – Output Voltage
($V_{DD}=12[V]$)

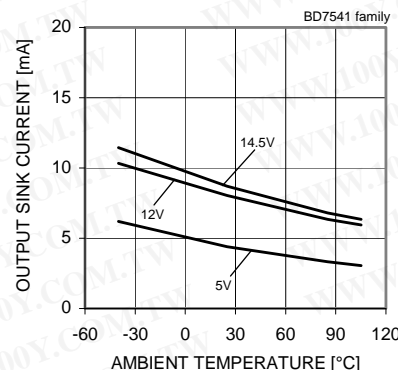

Fig. 58
Output Sink Current – Ambient Temperature
($V_{OUT}=V_{DD}-11.6[V]$)

(*)The above data is ability value of sample, it is not guaranteed. BD7541 : -40[°C]~+85[°C] BD7541S : -40[°C]~+105[°C]

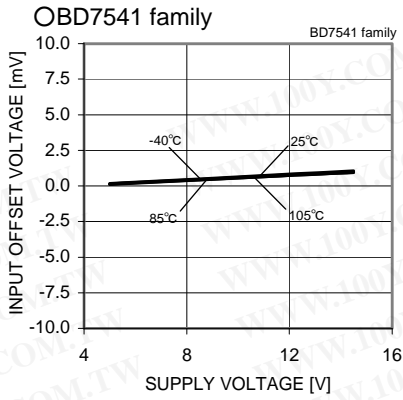

Fig. 59

Input Offset Voltage – Supply Voltage
($V_{icm}=V_{DD}$, $V_{OUT}=V_{DD}/2$)

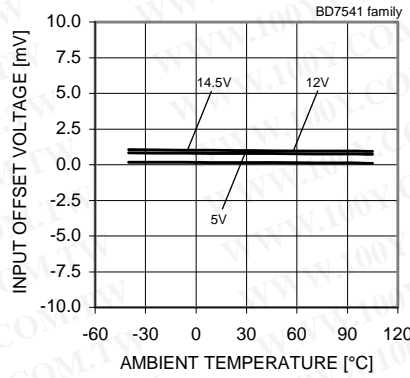

Fig. 60

Input Offset Voltage – Ambient Temperature
($V_{icm}=V_{DD}$, $V_{OUT}=V_{DD}/2$)

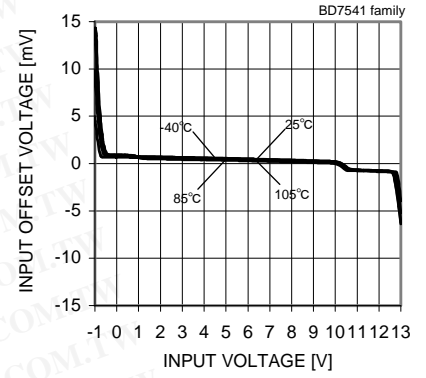

Fig. 61

Input Offset Voltage – Input Voltage
($V_{DD}=12[V]$)

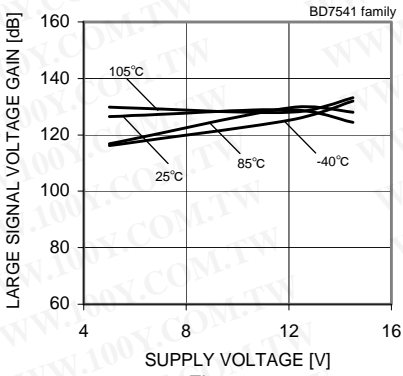

Fig. 62

Large Signal Voltage Gain
– Supply Voltage

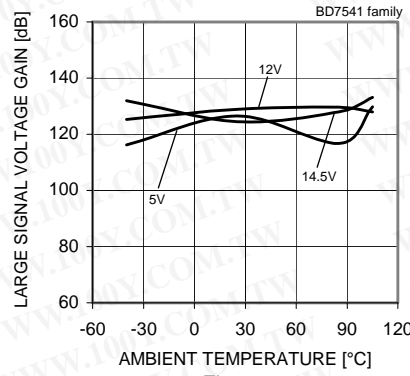

Fig. 63

Large Signal Voltage Gain
– Ambient Temperature

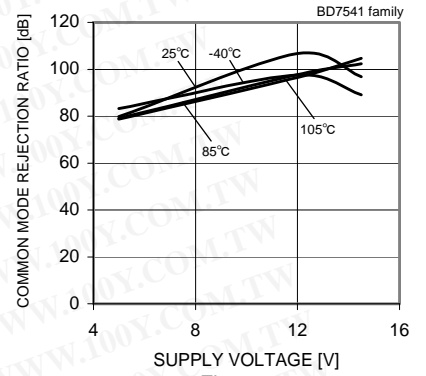

Fig. 64

Common Mode Rejection Ratio
– Supply Voltage
($V_{DD}=12[V]$)

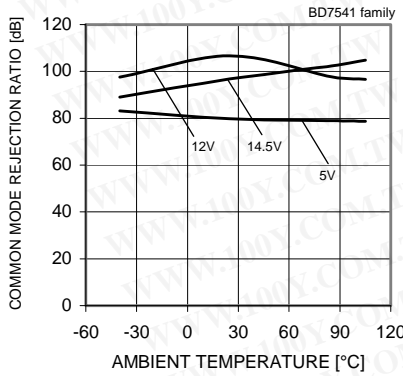

Fig. 65

Common Mode Rejection Ratio
– Ambient Temperature
($V_{DD}=12[V]$)

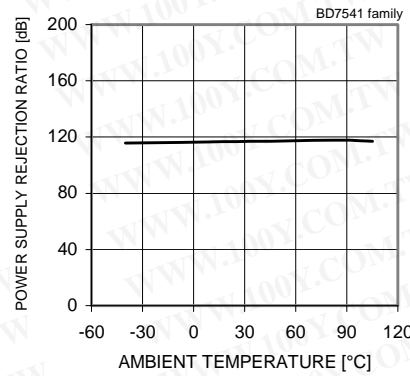

Fig. 66

Power Supply Rejection Ratio
– Ambient Temperature

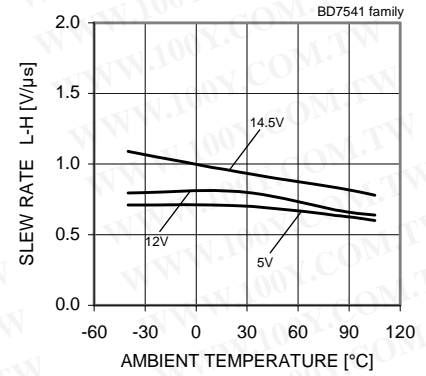

Fig. 67

Slew Rate L-H – Ambient Temperature

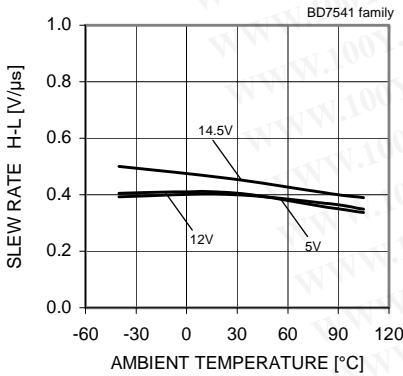

Fig. 68

Slew Rate H-L – Ambient Temperature

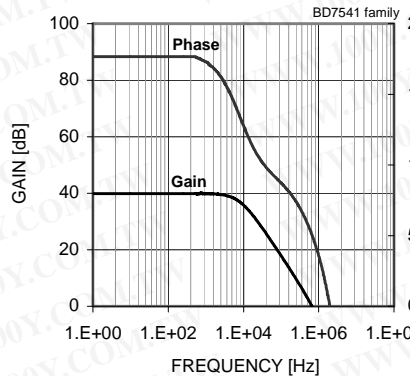

Fig. 69

Gain - Frequency

(*)The above data is ability value of sample, it is not guaranteed. BD7541 : -40[°C]~+85[°C] BD7541S : -40[°C]~+105[°C]

OBD7542 family

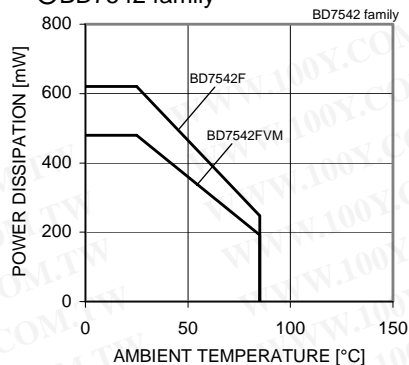

Fig. 70 Derating Curve

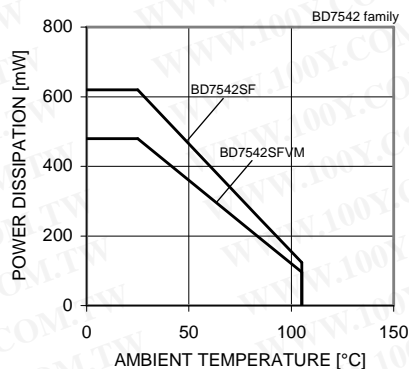

Fig. 71 Derating Curve

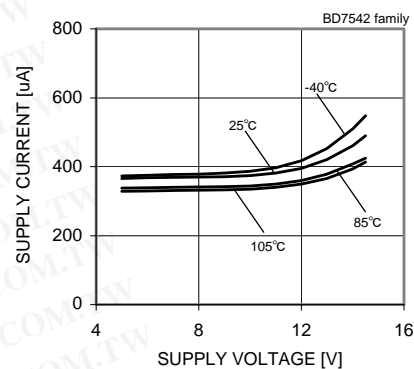

Fig. 72 Supply Current - Supply Voltage

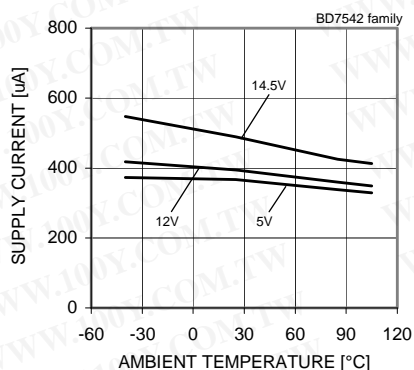

Fig. 73 Supply Current - Ambient Temperature

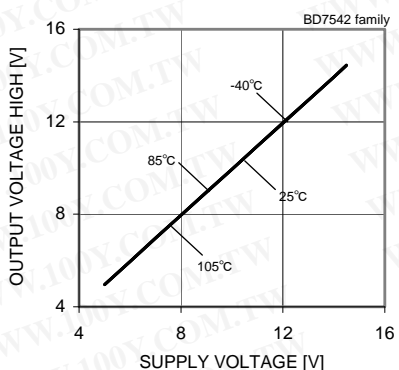

Fig. 74 Output Voltage High - Supply Voltage (RL=10[kΩ])

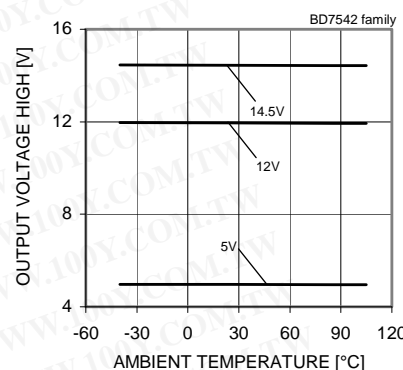

Fig. 75 Output Voltage High - Ambient Temperature (RL=10[kΩ])

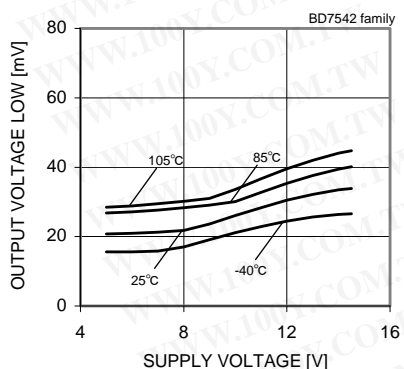

Fig. 76 Output Voltage Low - Supply Voltage (RL=10[kΩ])

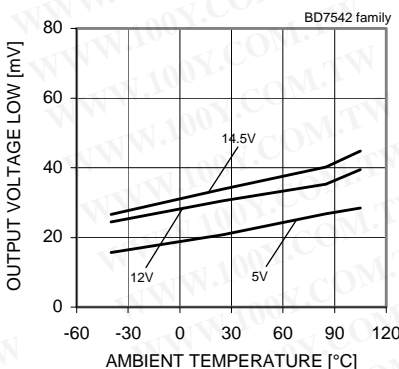

Fig. 77 Output Voltage Low - Ambient Temperature (RL=10[kΩ])

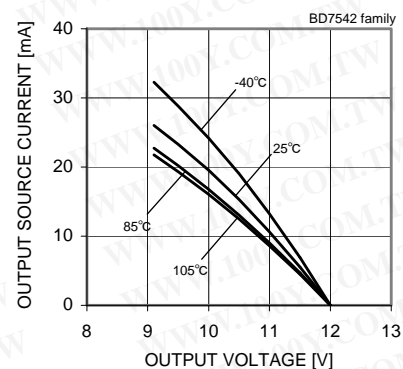

Fig. 78 Output Source Current - Output Voltage (VDD=12[V])

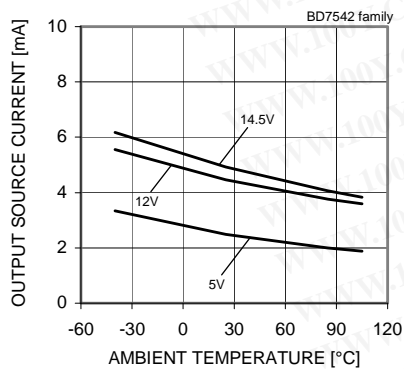

Fig. 79 Output Source Current - Ambient Temperature (VOUT=VDD-0.4[V])

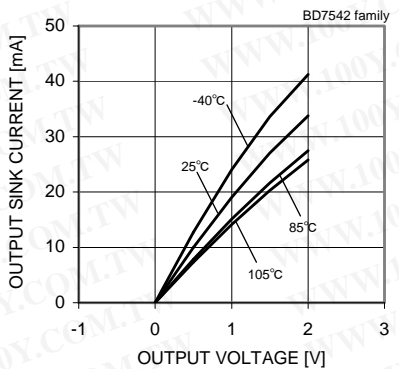

Fig. 80 Output Sink Current - Output Voltage (VDD=12[V])

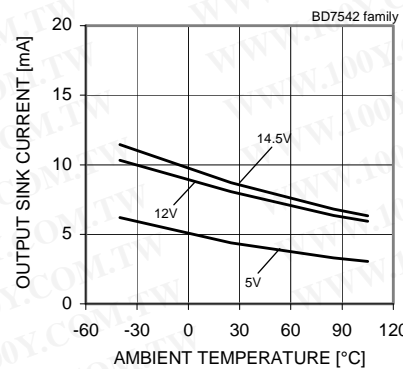

Fig. 81 Output Sink Current - Ambient Temperature (VOUT=VDD-11.6[V])

(*)The above data is ability value of sample, it is not guaranteed. BD7561 : -40[°C]~+85[°C] BD7561S : -40[°C]~+105[°C]

OBD7542 family

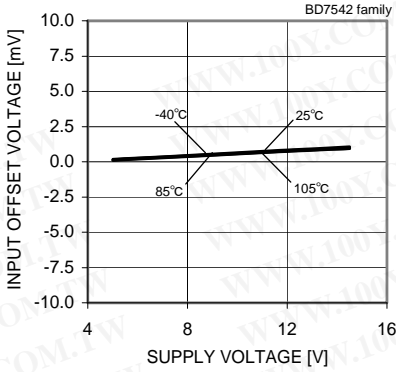

Fig. 82

Input Offset Voltage – Supply Voltage
($V_{icm}=V_{DD}$, $V_{OUT}=V_{DD}/2$)

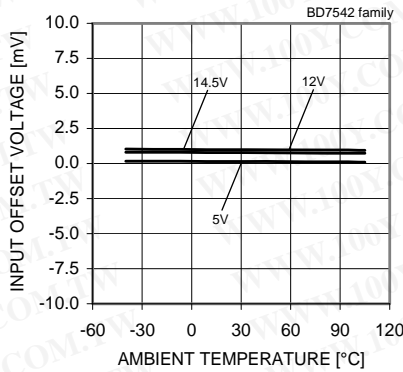

Fig. 83

Input Offset Voltage – Ambient Temperature
($V_{icm}=V_{DD}$, $V_{OUT}=V_{DD}/2$)

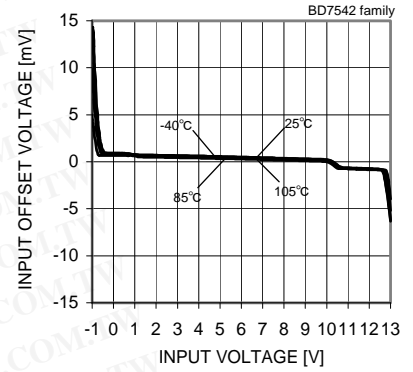

Fig. 84

Input Offset Voltage – Input Voltage
($V_{DD}=12[V]$)

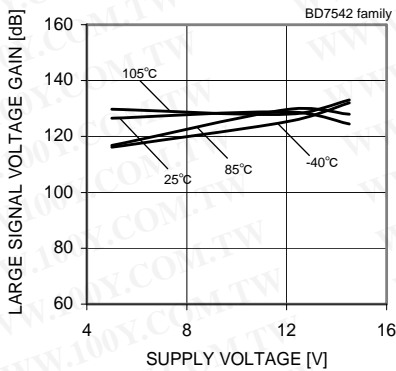

Fig. 85

Large Signal Voltage Gain
– Supply Voltage

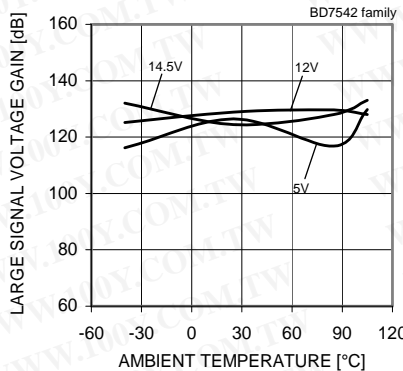

Fig. 86

Large Signal Voltage Gain
– Ambient Temperature

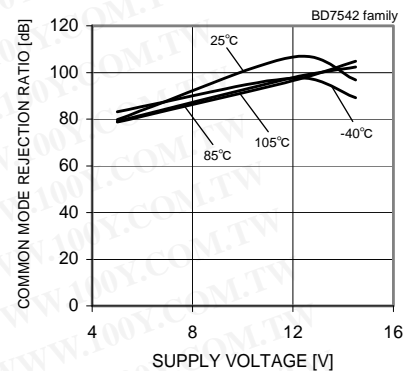

Fig. 87

Common Mode Rejection Ratio
– Supply Voltage
($V_{DD}=12[V]$)

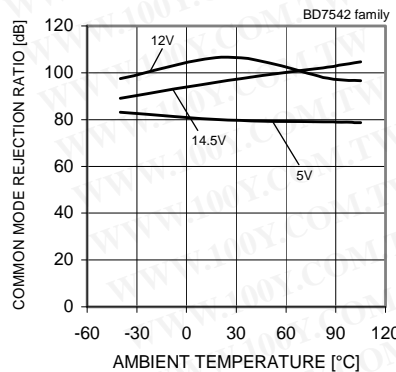

Fig. 88

Common Mode Rejection Ratio
– Ambient Temperature
($V_{DD}=12[V]$)

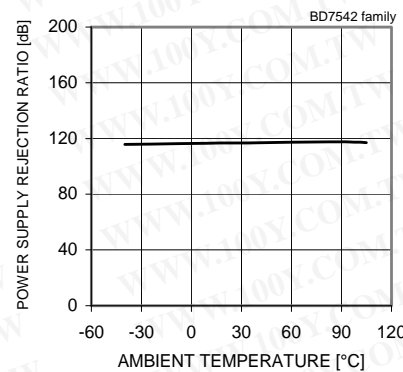

Fig. 89

Power Supply Rejection Ratio
– Ambient Temperature

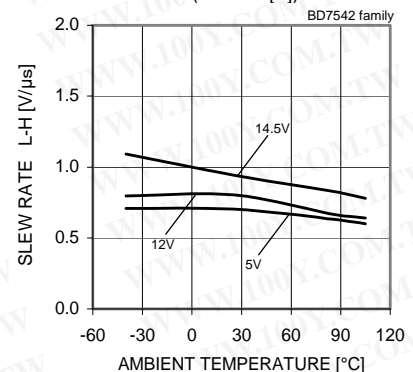

Fig. 90

Slew Rate L-H – Ambient Temperature

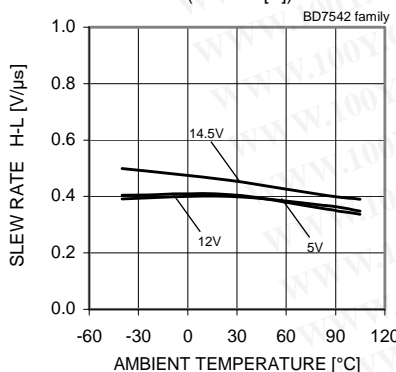

Fig. 91

Slew Rate H-L – Ambient
Temperature

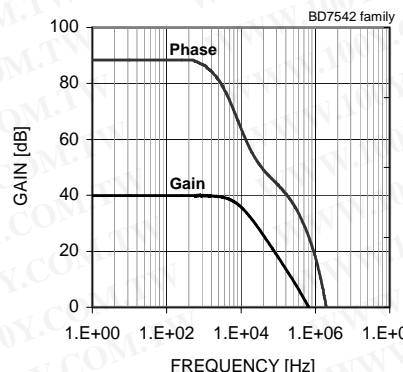

Fig. 92

Gain - Frequency

(*)The above data is ability value of sample, it is not guaranteed. BD7561 : -40[°C]~+85[°C] BD7561S : -40[°C]~+105[°C]

● Schematic diagram

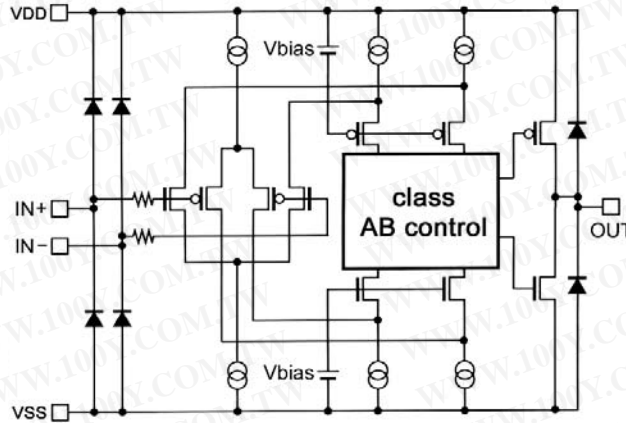

Fig. 93. Schematic diagram

● Test circuit1 NULL method

VDD, VSS, EK, Vicm Unit : [V]

Parameter	VF	S1	S2	S3	VDD	VSS	EK	Vicm	Calculation
Input Offset Voltage	VF1	ON	ON	OFF	12	0	-6	12	1
Large Signal Voltage Gain	VF2	ON	ON	ON	12	0	-0.5	6	2
	VF3						-11.5		
Common-mode Rejection Ratio (Input Common-mode Voltage Range)	VF4	ON	ON	OFF	12	0	-6	0	3
	VF5						12		
Power Supply Rejection Ratio	VF6	ON	ON	OFF	5	0	-2.5	0	4
	VF7				14.5				

-Calculation-

1. Input Offset Voltage (Vio)

$$V_{io} = \frac{|VF1|}{1+R_f/R_s} \text{ [V]}$$

2. Large Signal Voltage Gain (Av)

$$A_v = 20 \log \frac{2 \times (1+R_f/R_s)}{|VF2-VF3|} \text{ [dB]}$$

3. Common-mode Rejection Ratio (CMRR)

$$CMRR = 20 \log \frac{1.8 \times (1+R_f/R_s)}{|VF4-VF5|} \text{ [dB]}$$

4. Power Supply Rejection Ratio (PSRR)

$$PSRR = 20 \log \frac{3.8 \times (1+R_f/R_s)}{|VF6-VF7|} \text{ [dB]}$$

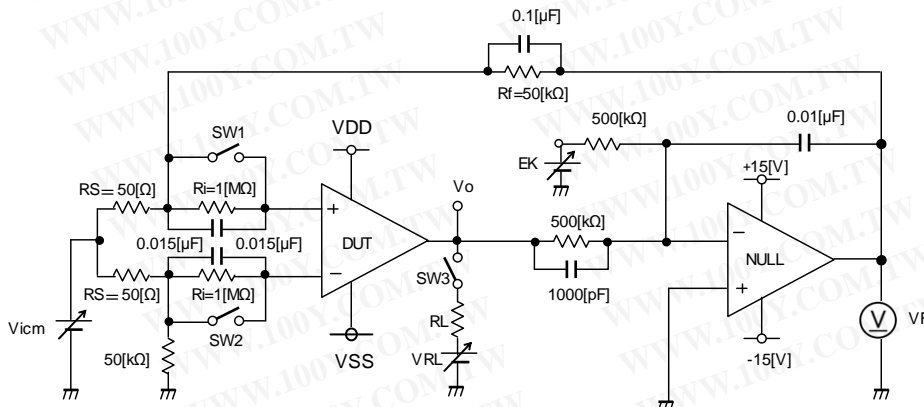

Fig. 94. Test circuit 1 (one channel only)

● Test circuit2 switch condition

Unit : [V]

SW No.	SW 1	SW 2	SW 3	SW 4	SW 5	SW 6	SW 7	SW 8	SW 9	SW 10	SW 11	SW 12
Supply Current	OFF	OFF	ON	OFF	ON	OFF	OFF	OFF	OFF	OFF	OFF	OFF
Maximum Output Voltage RL=10 [kΩ]	OFF	ON	OFF	OFF	ON	OFF	OFF	ON	OFF	OFF	ON	OFF
Output Current	OFF	ON	OFF	OFF	ON	OFF	OFF	OFF	OFF	ON	OFF	OFF
Slew Rate	OFF	OFF	ON	OFF	OFF	OFF	ON	OFF	ON	OFF	OFF	ON
Maximum Frequency	ON	OFF	OFF	ON	ON	OFF	OFF	OFF	ON	OFF	OFF	ON

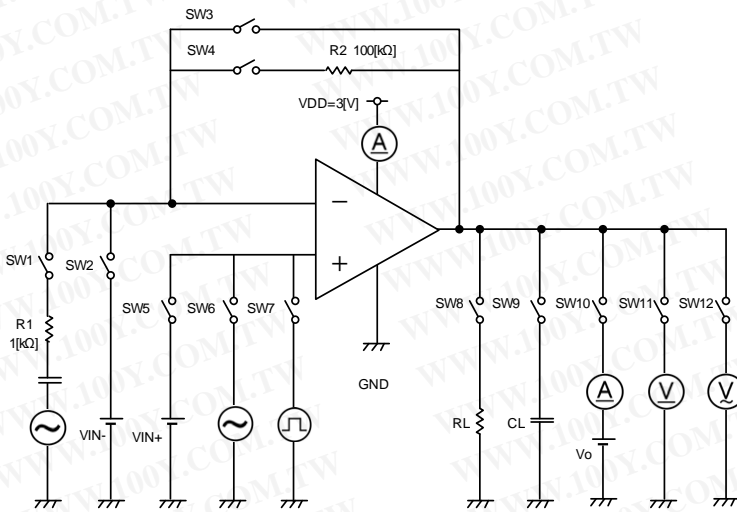

Fig. 95.. Test circuit2

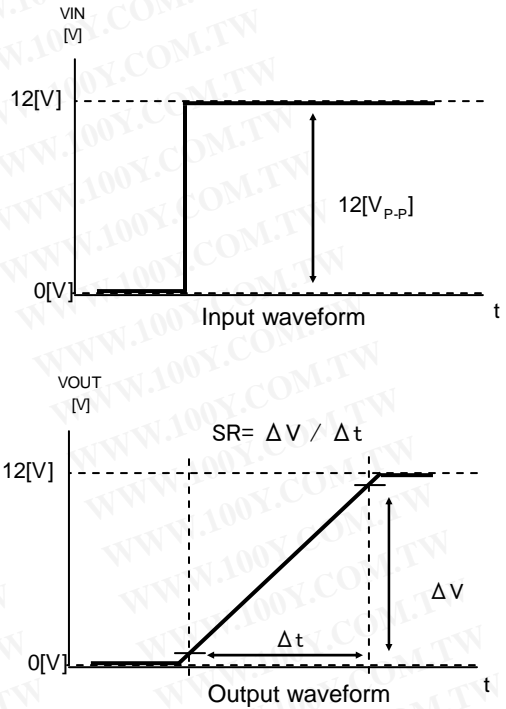

Fig. 96.. Slew rate input output wave

● Test circuit3 Channel separation

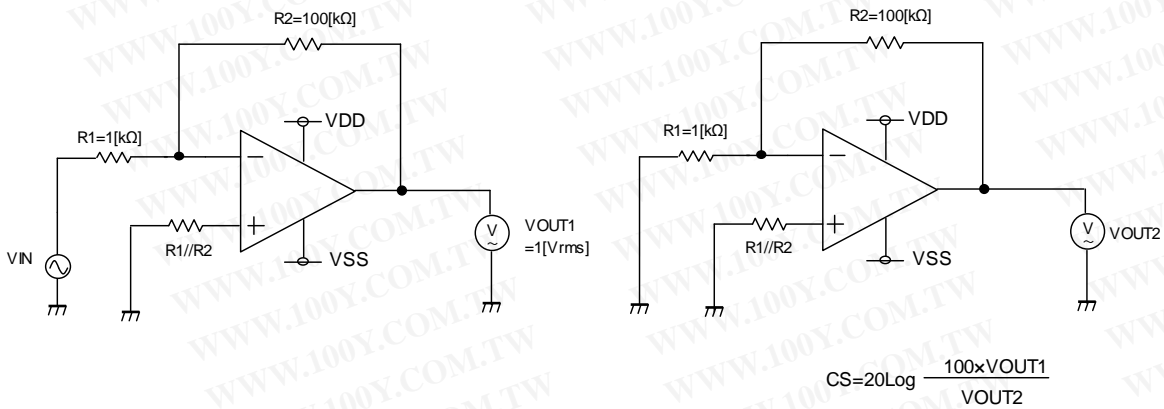

Fig. 97.. Test circuit3

● Description of electrical characteristics

Described here are the terms of electric characteristics used in this technical note. Items and symbols used are also shown. Note that item name and symbol and their meaning may differ from those on another manufacture's document or general document.

1. Absolute maximum ratings

Absolute maximum rating item indicates the condition which must not be exceeded. Application of voltage in excess of absolute maximum rating or use out of absolute maximum rated temperature environment may cause deterioration of characteristics.

1.1 Power supply voltage (VDD/VSS)

Indicates the maximum voltage that can be applied between the positive power supply terminal and negative power supply terminal without deterioration or destruction of characteristics of internal circuit.

1.2 Differential input voltage (Vid)

Indicates the maximum voltage that can be applied between non-inverting terminal and inverting terminal without deterioration and destruction of characteristics of IC.

1.3 Input common-mode voltage range (Vicm)

Indicates the maximum voltage that can be applied to non-inverting terminal and inverting terminal without deterioration or destruction of characteristics. Input common-mode voltage range of the maximum ratings not assure normal operation of IC. When normal Operation of IC is desired, the input common-mode voltage of characteristics item must be followed.

1.4 Power dissipation (Pd)

Indicates the power that can be consumed by specified mounted board at the ambient temperature 25°C (normal temperature). As for package product, Pd is determined by the temperature that can be permitted by IC chip in the package (maximum junction temperature) and thermal resistance of the package.

2. Electrical characteristics item**2.1 Input offset voltage (Vio)**

Indicates the voltage difference between non-inverting terminal and inverting terminal. It can be translated into the input voltage difference required for setting the output voltage at 0 [V].

2.2 Input offset current (Iio)

Indicates the difference of input bias current between non-inverting terminal and inverting terminal.

2.3 Input bias current (Ib)

Indicates the current that flows into or out of the input terminal. It is defined by the average of input bias current at non-inverting terminal and input bias current at inverting terminal.

2.4 Circuit current (ICC)

Indicates the IC current that flows under specified conditions and no-load steady status.

2.5 High level output voltage / Low level output voltage (VOH/VOL)

Indicates the voltage range that can be output by the IC under specified load condition. It is typically divided into high-level output voltage and low-level output voltage. High-level output voltage indicates the upper limit of output voltage. Low-level output voltage indicates the lower limit.

2.6 Large signal voltage gain (AV)

Indicates the amplifying rate (gain) of output voltage against the voltage difference between non-inverting terminal and inverting terminal. It is normally the amplifying rate (gain) with reference to DC voltage.

$A_v = (\text{Output voltage fluctuation}) / (\text{Input offset fluctuation})$

2.7 Input common-mode voltage range (Vicm)

Indicates the input voltage range where IC operates normally.

2.8 Common-mode rejection ratio (CMRR)

Indicates the ratio of fluctuation of input offset voltage when in-phase input voltage is changed. It is normally the fluctuation of DC.

$CMRR = (\text{Change of Input common-mode voltage}) / (\text{Input offset fluctuation})$

2.9 Power supply rejection ratio (PSRR)

Indicates the ratio of fluctuation of input offset voltage when supply voltage is changed. It is normally the fluctuation of DC.

$PSRR = (\text{Change of power supply voltage}) / (\text{Input offset fluctuation})$

2.10 Channel separation (CS)

Indicates the fluctuation of input offset voltage or that of output voltage with reference to the change of output voltage of driven channel.

2.11 Slew rate (SR)

Indicates the time fluctuation ratio of voltage output when step input signal is applied.

2.12 Unity gain frequency (ft)

Indicates a frequency where the voltage gain of Op-Amp is 1.

2.13 Total harmonic distortion + Noise (THD+N)

Indicates the fluctuation of input offset voltage or that of output voltage with reference to the change of output voltage of driven channel.

2.14 Input referred noise voltage (Vn)

Indicates a noise voltage generated inside the operational amplifier equivalent by ideal voltage source connected in series with input terminal.

● Derating curve

Power dissipation (total loss) indicates the power that can be consumed by IC at Ta=25°C(normal temperature). IC is heated when it consumed power, and the temperature of IC chip becomes higher than ambient temperature. The temperature that can be accepted by IC chip depends on circuit configuration, manufacturing process, and consumable power is limited. Power dissipation is determined by the temperature allowed in IC chip (maximum junction temperature) and thermal resistance of package (heat dissipation capability). The maximum junction temperature is typically equal to the maximum value in the storage package (heat dissipation capability). The maximum junction temperature is typically equal to the maximum value in the storage temperature range. Heat generated by consumed power of IC radiates from the mold resin or lead frame of the package. The parameter which indicates this heat dissipation capability (hardness of heat release) is called thermal resistance, represented by the symbol θ_{j-a} [°C/W]. The temperature of IC inside the package can be estimated by this thermal resistance. Fig.98 (a) shows the model of thermal resistance of the package. Thermal resistance θ_{ja} , ambient temperature Ta, junction temperature Tj, and power dissipation Pd can be calculated by the equation below :

$$\theta_{ja} = (T_j - T_a) / P_d \quad [^{\circ}\text{C}/\text{W}] \quad \dots \dots (I)$$

Derating curve in Fig.98 (b) indicates power that can be consumed by IC with reference to ambient temperature. Power that can be consumed by IC begins to attenuate at certain ambient temperature. This gradient is determined by thermal resistance θ_{ja} . Thermal resistance θ_{ja} depends on chip size, power consumption, package, ambient temperature, package condition, wind velocity, etc even when the same of package is used. Thermal reduction curve indicates a reference value measured at a specified condition. Fig99(c)-(f) show a derating curve for an example of BU7561family, BU7562family, 7541family, 7542family.

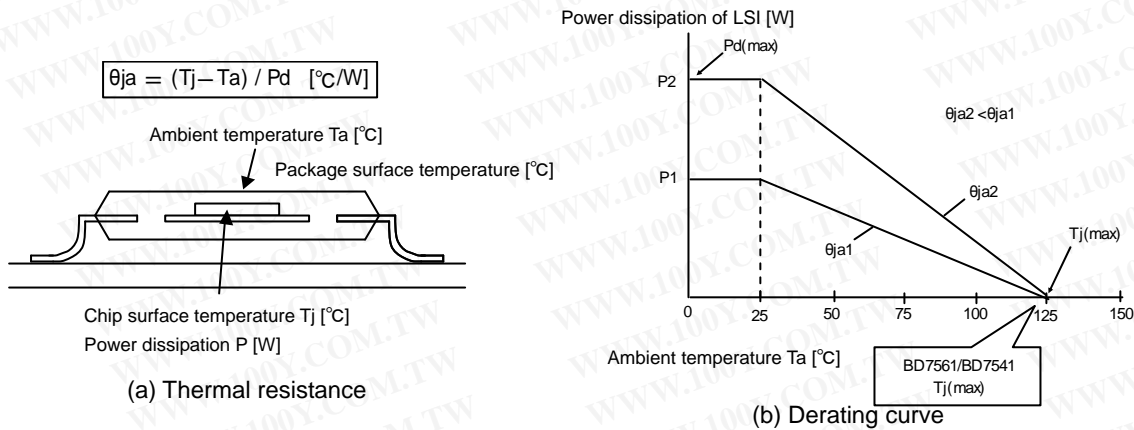
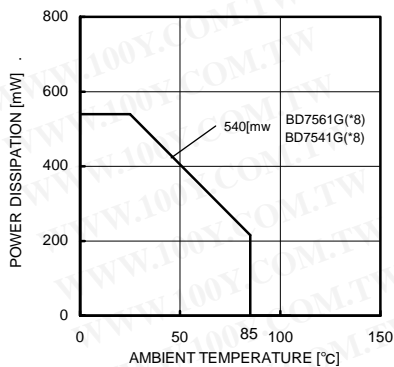
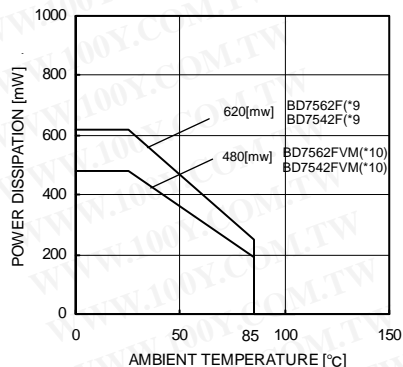

Fig. 98. Thermal resistance and derating



(c) BD7561G



(d) BD7562F/FVM BD7542F/FVM

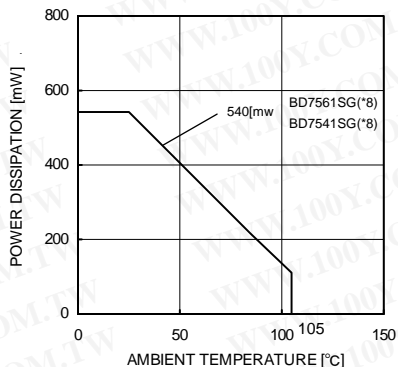

(e) BD7561SG

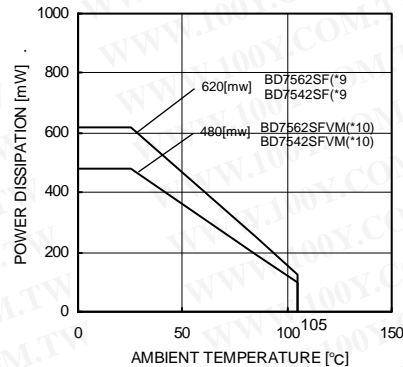

(f) BD7562S F/FVM BD7542S F/FVM

(*8)	(*9)	(*10)	Unit
5.4	6.2	4.8	[mW/°C]

When using the unit above $T_a=25[^\circ\text{C}]$, subtract the value above per degree $^\circ\text{C}$. Permissible dissipation is the value when FR4 glass epoxy board $70[\text{mm}] \times 70[\text{mm}] \times 1.6[\text{mm}]$ (cooper foil area below 3[%]) is mounted.

Fig. 99. Derating curve

●Notes for use

1) Absolute maximum ratings

Absolute maximum ratings are the values which indicate the limits, within which the given voltage range can be safely charged to the terminal. However, it does not guarantee the circuit operation.

2) Applied voltage to the input terminal

For normal circuit operation of voltage comparator, please input voltage for its input terminal within input common mode voltage $V_{DD}+0.3[V]$. Then, regardless of power supply voltage, $V_{SS}-0.3[V]$ can be applied to input terminals without deterioration or destruction of its characteristics.

3) Operating power supply (split power supply/single power supply)

The voltage comparator operates if a given level of voltage is applied between V_{DD} and V_{SS} . Therefore, the operational amplifier can be operated under single power supply or split power supply.

4) Power dissipation (P_d)

If the IC is used under excessive power dissipation. An increase in the chip temperature will cause deterioration of the radical characteristics of IC. For example, reduction of current capability. Take consideration of the effective power dissipation and thermal design with a sufficient margin. P_d is reference to the provided power dissipation curve.

5) Short circuits between pins and incorrect mounting

Short circuits between pins and incorrect mounting when mounting the IC on a printed circuits board, take notice of the direction and positioning of the IC. If IC is mounted erroneously, it may be damaged. Also, when a foreign object is inserted between output, between output and V_{DD} terminal or V_{SS} terminal which causes short circuit, the IC may be damaged.

6) Using under strong electromagnetic field

Be careful when using the IC under strong electromagnetic field because it may malfunction.

7) Usage of IC

When stress is applied to the IC through warp of the printed circuit board, the characteristics may fluctuate due to the piezo effect. Be careful of the warp of the printed circuit board.

8) Testing IC on the set board

When testing IC on the set board, in cases where the capacitor is connected to the low impedance, make sure to discharge per fabrication because there is a possibility that IC may be damaged by stress.

When removing IC from the set board, it is essential to cut supply voltage. As a countermeasure against the static electricity, observe proper grounding during fabrication process and take due care when carrying and storage it.

9) The IC destruction caused by capacitive load

The transistors in circuits may be damaged when V_{DD} terminal and V_{SS} terminal is shorted with the charged output terminal capacitor. When IC is used as an operational amplifier or as an application circuit, where oscillation is not activated by an output capacitor, the output capacitor must be kept below $0.1[\mu F]$ in order to prevent the damage mentioned above.

10) Decoupling capacitor

Insert the decoupling capacitance between V_{DD} and V_{SS} , for stable operation of operational amplifier.

11) Latch up

Be careful of input voltage that exceed the V_{DD} and V_{SS} . When CMOS device have sometimes occur latch up operation.

And protect the IC from abnormal noise.

● Ordering part number

B D

ローム形名

7 5 6 2

品番

7561, 7561S
7541, 7541S
7562, 7562S
7542, 7542S

F V M -

パッケージ

G: SSOP5
F: SOP8
FVM: MSOP8

T R

Packaging and forming specification

E2: Embossed tape and reel (SOP8)
TR: Embossed tape and reel (SSOP5/MSOP8)

SOP8

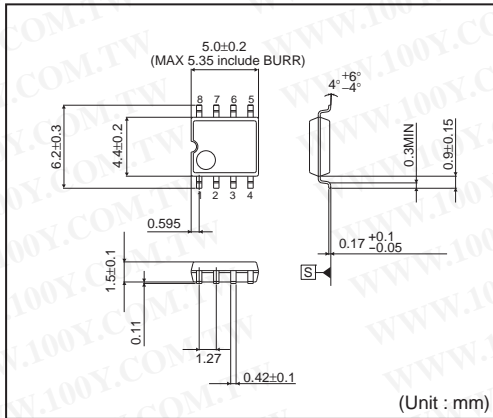

<Tape and Reel information>

Tape	Embossed carrier tape
Quantity	2500pcs
Direction of feed	E2 (The direction is the 1pin of product is at the upper left when you hold reel on the left hand and you pull out the tape on the right hand)

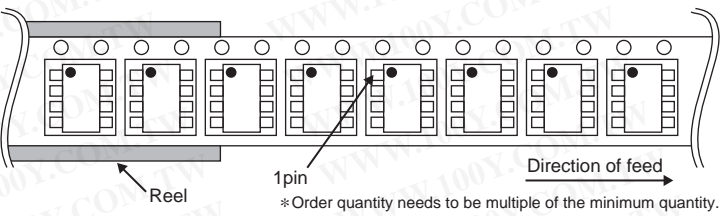

SSOP5

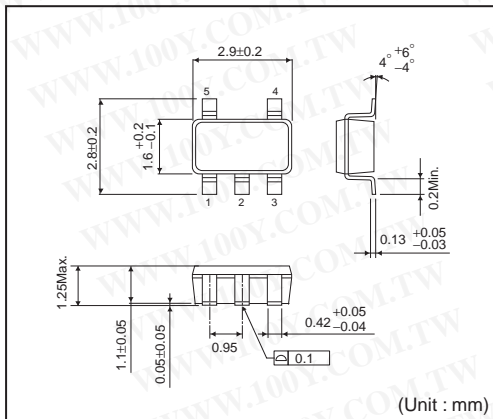

<Tape and Reel information>

Tape	Embossed carrier tape
Quantity	3000pcs
Direction of feed	TR (The direction is the 1pin of product is at the upper right when you hold reel on the left hand and you pull out the tape on the right hand)

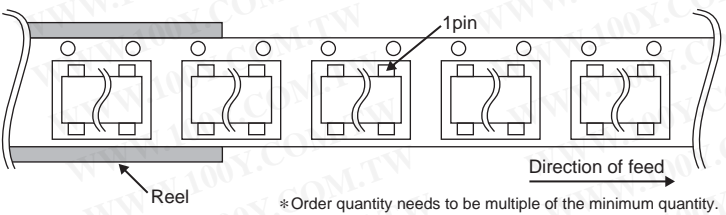

MSOP8

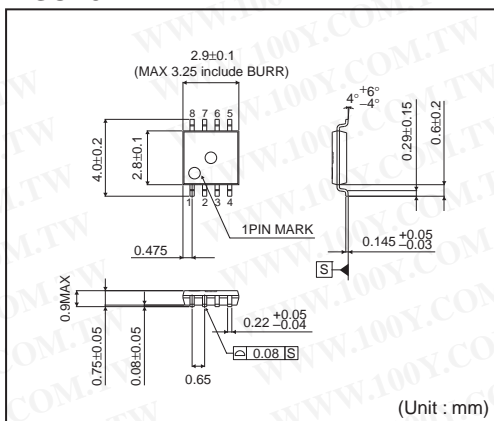

<Tape and Reel information>

Tape	Embossed carrier tape
Quantity	3000pcs
Direction of feed	TR (The direction is the 1 pin of product is at the upper right when you hold reel on the left hand and you pull out the tape on the right hand)

Reel

1pin

Direction of feed

*Order quantity needs to be multiple of the minimum quantity.

勝特力材料 886-3-5753170
勝特力电子(上海) 86-21-34970699
勝特力电子(深圳) 86-755-83298787
[Http://www.100y.com.tw](http://www.100y.com.tw)

Notes

No copying or reproduction of this document, in part or in whole, is permitted without the consent of ROHM Co.,Ltd.

The content specified herein is subject to change for improvement without notice.

The content specified herein is for the purpose of introducing ROHM's products (hereinafter "Products"). If you wish to use any such Product, please be sure to refer to the specifications, which can be obtained from ROHM upon request.

Examples of application circuits, circuit constants and any other information contained herein illustrate the standard usage and operations of the Products. The peripheral conditions must be taken into account when designing circuits for mass production.

Great care was taken in ensuring the accuracy of the information specified in this document. However, should you incur any damage arising from any inaccuracy or misprint of such information, ROHM shall bear no responsibility for such damage.

The technical information specified herein is intended only to show the typical functions of and examples of application circuits for the Products. ROHM does not grant you, explicitly or implicitly, any license to use or exercise intellectual property or other rights held by ROHM and other parties. ROHM shall bear no responsibility whatsoever for any dispute arising from the use of such technical information.

The Products specified in this document are intended to be used with general-use electronic equipment or devices (such as audio visual equipment, office-automation equipment, communication devices, electronic appliances and amusement devices).

The Products specified in this document are not designed to be radiation tolerant.

While ROHM always makes efforts to enhance the quality and reliability of its Products, a Product may fail or malfunction for a variety of reasons.

Please be sure to implement in your equipment using the Products safety measures to guard against the possibility of physical injury, fire or any other damage caused in the event of the failure of any Product, such as derating, redundancy, fire control and fail-safe designs. ROHM shall bear no responsibility whatsoever for your use of any Product outside of the prescribed scope or not in accordance with the instruction manual.

The Products are not designed or manufactured to be used with any equipment, device or system which requires an extremely high level of reliability the failure or malfunction of which may result in a direct threat to human life or create a risk of human injury (such as a medical instrument, transportation equipment, aerospace machinery, nuclear-reactor controller, fuel-controller or other safety device). ROHM shall bear no responsibility in any way for use of any of the Products for the above special purposes. If a Product is intended to be used for any such special purpose, please contact a ROHM sales representative before purchasing.

If you intend to export or ship overseas any Product or technology specified herein that may be controlled under the Foreign Exchange and the Foreign Trade Law, you will be required to obtain a license or permit under the Law.



Thank you for your accessing to ROHM product informations.
More detail product informations and catalogs are available, please contact us.

ROHM Customer Support System

<http://www.rohm.com/contact/>