



勝特力材料 886-3-5753170
勝特力电子(上海) 86-21-34970699
勝特力电子(深圳) 86-755-83298787
[Http://www.100y.com.tw](http://www.100y.com.tw)

TS391

LOW POWER SINGLE VOLTAGE COMPARATORS

- WIDE SINGLE SUPPLY VOLTAGE RANGE OR DUAL SUPPLIES +2V TO +36V OR $\pm 1V$ TO $\pm 18V$
- VERY LOW SUPPLY CURRENT (0.2mA) INDEPENDENT OF SUPPLY VOLTAGE (1 mW/comparator at +5V)
- LOW INPUT BIAS CURRENT : 25nA TYP
- LOW INPUT OFFSET CURRENT : $\pm 5nA$ TYP
- LOW INPUT OFFSET VOLTAGE : $\pm 1mV$ TYP
- INPUT COMMON-MODE VOLTAGE RANGE INCLUDES GROUND
- LOW OUTPUT SATURATION VOLTAGE : 250mV TYP. ($I_o = 4mA$)
- DIFFERENTIAL INPUT VOLTAGE RANGE EQUAL TO THE SUPPLY VOLTAGE
- TTL, DTL, ECL, MOS, CMOS COMPATIBLE OUTPUTS

DESCRIPTION

These devices consist of a low power voltage comparator designed specifically to operate from a single supply over a wide range of voltages. Operation from split power supplies is also possible.

This comparator also has a unique characteristic in that the input common-mode voltage range includes ground even though operated from a single power supply voltage.

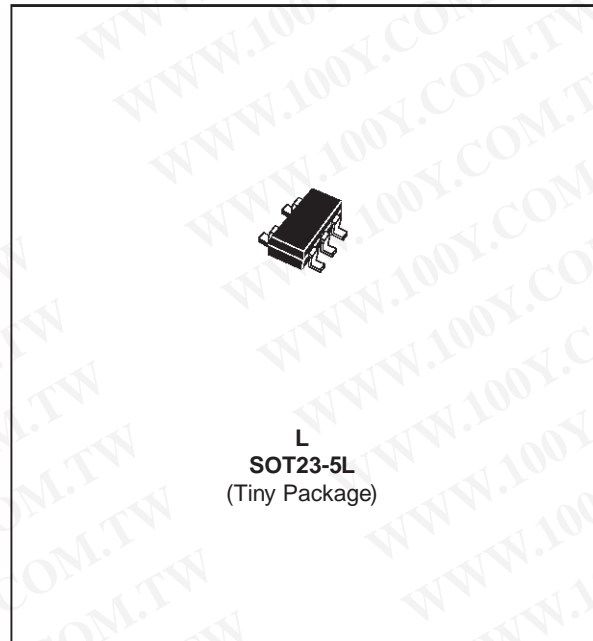

ORDER CODES

Part Number	Temperature Range	Package
		L
TS391IL	-40, +125°C	•
Example : TS391IL		

PIN CONNECTIONS (top view)

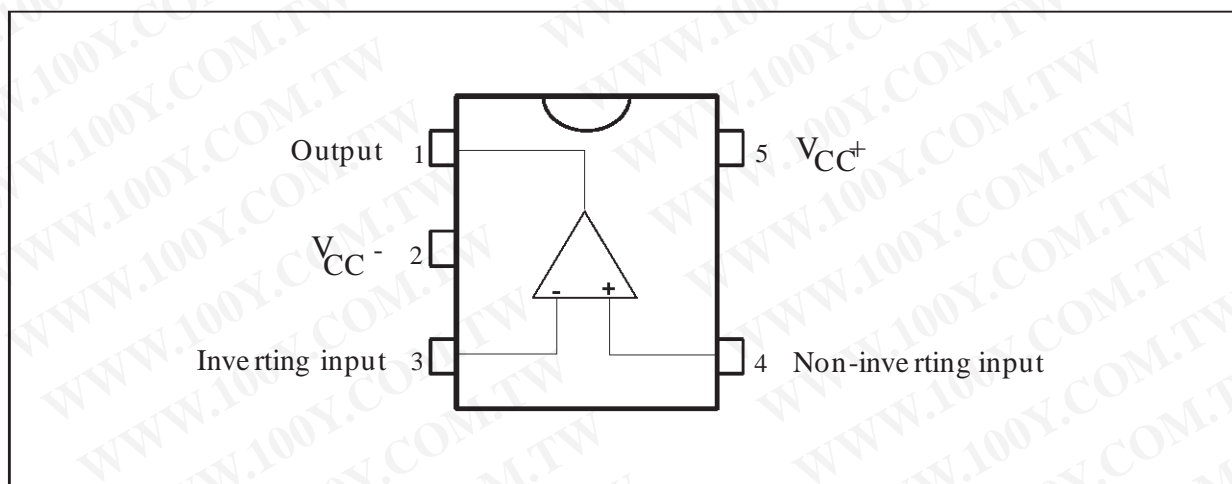

ELECTRICAL CHARACTERISTICS
 $V_{CC}^+ = +5V$, $V_{CC}^- = 0V$, $T_{amb} = 25^{\circ}C$ (unless otherwise specified)

Symbol	Parameter	Min.	Typ.	Max.	Unit
V_{io}	Input Offset Voltage – (note 2) $T_{amb} = +25^{\circ}C$ $T_{min.} \leq T_{amb} \leq T_{max.}$		1	5 9	mV
I_{ib}	Input Bias Current – (note 3) $T_{amb} = +25^{\circ}C$ $T_{min.} \leq T_{amb} \leq T_{max.}$		25	250 400	nA
I_{io}	Input Offset Current $T_{amb} = +25^{\circ}C$ $T_{min.} \leq T_{amb} \leq T_{max.}$		5	50 150	nA
A_{vd}	Large Signal Voltage Gain $V_{CC} = 15V$, $R_L = 15k\Omega$, $V_O = 1$ to $11V$	50	200		V/mV
I_{CC}	Supply Current $V_{CC} = 5V$, no load $V_{CC} = 30V$, no load		0.2 0.5	0.5 1.25	mA
V_{icm}	Input Common Mode Voltage Range - (note 4) $T_{amb} = +25^{\circ}C$ $T_{min.} \leq T_{amb} \leq T_{max.}$	0 0		$V_{CC}^+ - 1.5$ $V_{CC}^+ - 2$	V
V_{id}	Differential Input Voltage - (note 6)			V_{CC}^+	V
I_{sink}	Output Sink Current ($V_{id} = -1V$, $V_O = 1.5V$)	6	16		mA
V_{OL}	Low Level Output Voltage ($V_{id} = -1V$, $I_{sink} = 4mA$) $T_{amb} = 25^{\circ}C$ $T_{min.} \leq T_{amb} \leq T_{max}$		250	400 700	mV
I_{OH}	High Level Output Current ($V_{id} = 1V$, $V_{CC} = V_O = 30V$) $T_{amb} = 25^{\circ}C$ $T_{min.} \leq T_{amb} \leq T_{max}$		0.1	1	nA μA
t_{re}	Response Time ($R_L = 5.1k\Omega$ to V_{CC}^+) – (note 5)		1.3		μs
t_{rel}	Large Signal Response Time ($V_i = TTL$, $V_{ref} = +1.4V$, $R_L = 5.1k\Omega$ to V_{CC}^+)		300		ns

- Notes :**
- At output switch point, $V_O \approx 1.4V$, $R_s = 0\Omega$ with V_{CC}^+ from 5V to 30V and over the full input common-mode range (0V to $V_{CC}^+ - 1.5V$).
 - The direction of the input current is out of the IC due to the PNP input stage. This current is essentially constant, independent of the state of the output, so no loading charge exists on the reference or input lines.
 - The input common-mode voltage of either input signal voltage should not be allowed to go negative by more than 0.3V.
The upper end of the common-mode voltage range is $V_{CC}^+ - 1.5V$, but either or both inputs can go to +30V without damage.
 - The response time specified is for a 100mV input step with 5mV overdrive. For larger overdrive signals 300ns can be obtained.
 - Positive excursions of input voltage may exceed the power supply level. As long as the other voltage remains within the common-mode range the comparator will provide a proper output state. The low input voltage state must not be less than $-0.3V$ (or 0.3V below the negative power supply, if used).

SUPPLY CURRENT versus SUPPLY VOLTAGE

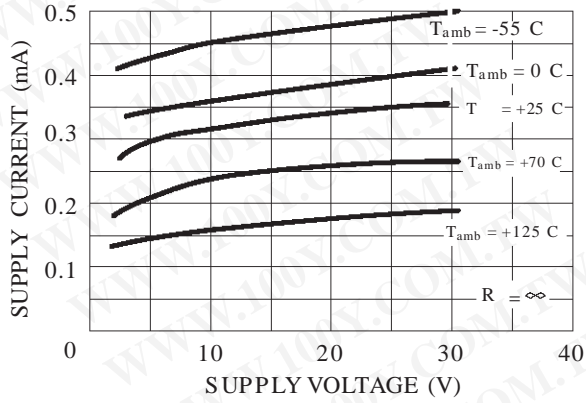

INPUT CURRENT versus SUPPLY VOLTAGE

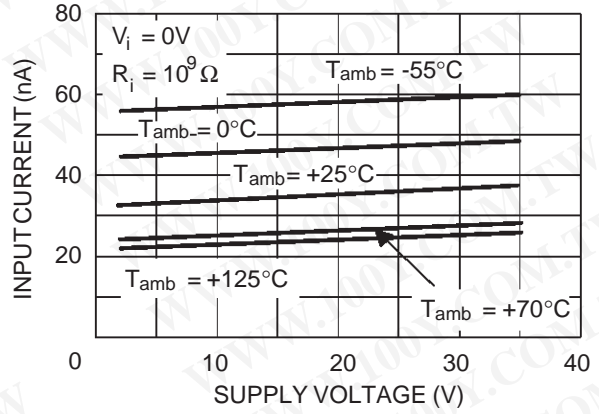

OUTPUT SATURATION VOLTAGE versus OUTPUT CURRENT

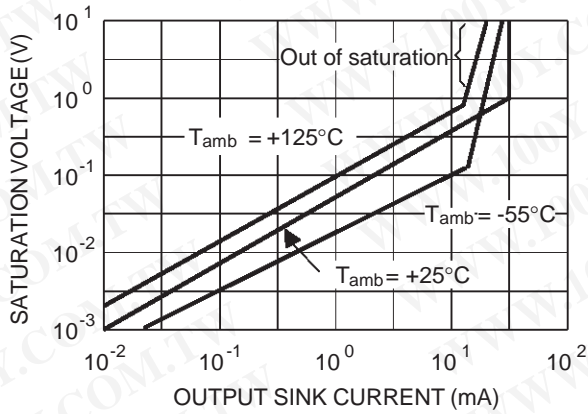

RESPONSE TIME FOR VARIOUS INPUT OVERDRIVES - NEGATIVE TRANSITION

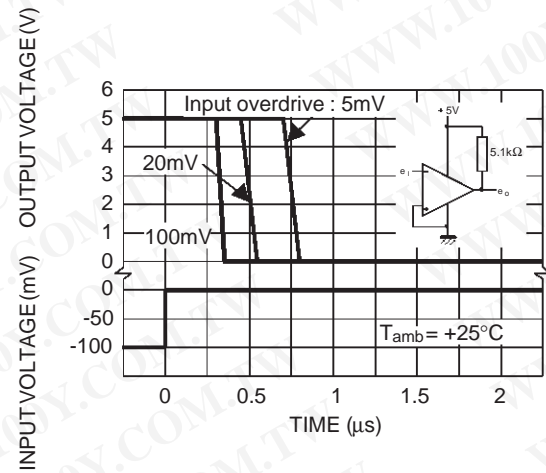

RESPONSE TIME FOR VARIOUS INPUT OVERDRIVES - POSITIVE TRANSITION

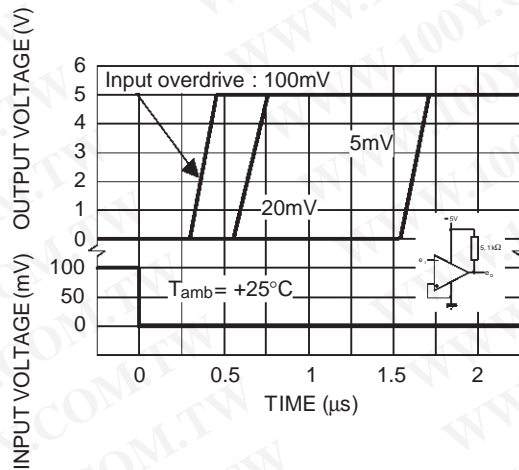

PACKAGE MECHANICAL DATA
5 PINS -TINY PACKAGE (SOT23)

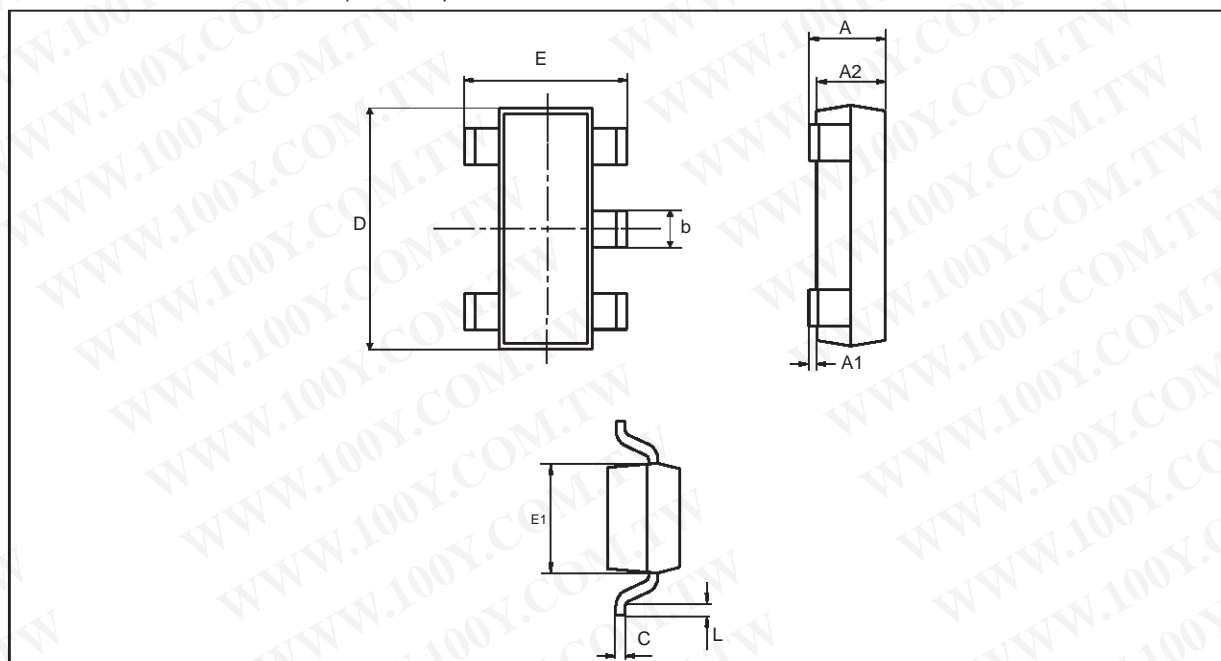

Dim.	Millimeters		Inches	
	Min.	Max.	Min.	Max.
A	0.90	1.45	0.034	0.057
A1	0	0.15		0.006
A2	0.90	1.30	0.034	0.051
b	0.35	0.50	0.013	0.020
C	0.09	0.20	0.003	0.008
D	2.80	3.00	0.110	0.118
E	2.60	3.00	0.102	0.118
E1	1.50	1.75	0.059	0.069
L	0.10	0.60	0.003	0.024

Information furnished is believed to be accurate and reliable. However, STMicroelectronics assumes no responsibility for the consequences of use of such information nor for any infringement of patents or other rights of third parties which may result from its use. No license is granted by implication or otherwise under any patent or patent rights of STMicroelectronics. Specifications mentioned in this publication are subject to change without notice. This publication supersedes and replaces all information previously supplied. STMicroelectronics products are not authorized for use as critical components in life support devices or systems without express written approval of STMicroelectronics.

© The ST logo is a trademark of STMicroelectronics

© 1998 STMicroelectronics – Printed in Italy – All Rights Reserved

STMicroelectronics GROUP OF COMPANIES

Australia - Brazil - Canada - China - France - Germany - Italy - Japan - Korea - Malaysia - Malta - Mexico - Morocco
 The Netherlands - Singapore - Spain - Sweden - Switzerland - Taiwan - Thailand - United Kingdom - U.S.A.

© <http://www.st.com>