



勝特力材料 886-3-5753170
勝特力电子(上海) 86-21-34970699
勝特力电子(深圳) 86-755-83298787
Http://www.100y.com.tw

TS921

Rail-to-Rail High Output Current Single Operational Amplifier

- Rail-to-rail input and output
- Low noise: 9nV/ $\sqrt{\text{Hz}}$
- Low distortion
- High output current: 80mA (able to drive 32 Ω loads)
- High-speed: 4MHz, 1V/ μs
- Operating from 2.7V to 12V
- ESD internal protection: 1.5kV
- Latch-up immunity
- Macromodel included in this specification

Description

The TS921 is a rail-to-rail single BiCMOS operational amplifier optimized and fully specified for 3V and 5V operation.

Its high output current allows low-load impedances to be driven.

The TS921 exhibits very low noise, low distortion and low offset. It has a high output current capability which makes this device an excellent choice for high quality, low voltage or battery-operated audio systems.

The device is stable for capacitive loads up to 500pF.

Applications

- Headphone amplifier
- Piezoelectric speaker driver
- Sound cards, multimedia systems
- Line driver, actuator driver
- Servo amplifier
- Mobile phone and portable communication sets
- Instrumentation with low noise as key factor

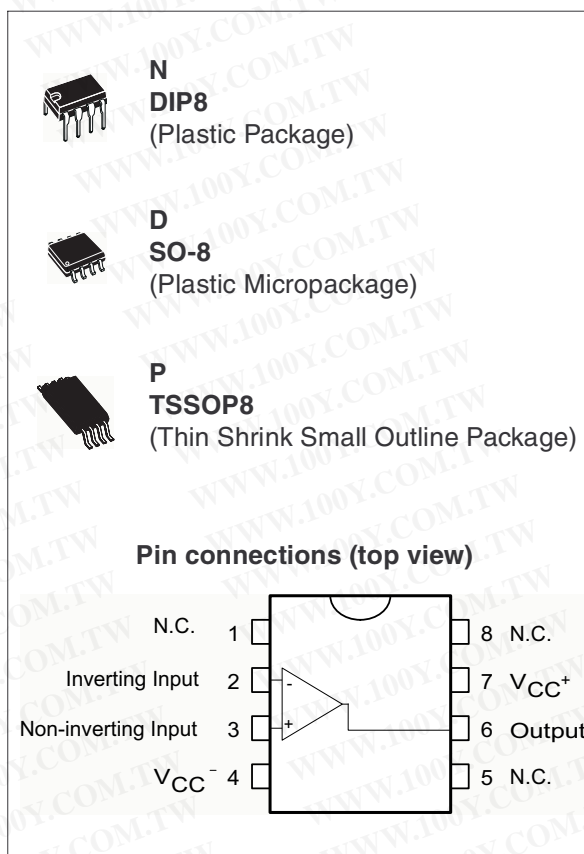

Order Codes

Part Number	Temperature Range	Package	Packing	Marking
TS921IN	-40°C, +125°C	DIP8	Tube	TS921IN
TS921ID/IDT		SO-8	Tube or Tape & Reel	921I
TS921IPT		TSSOP8 (Thin Shrink Outline Package)	Tape & Reel	
TS921IYD/IYDT		SO-8 (automotive grade level)	Tube or Tape & Reel	921IY

1 Absolute Maximum Ratings

Table 1. Key parameters and their absolute maximum ratings

Symbol	Parameter	Condition	Value	Unit
V _{CC}	Supply voltage ⁽¹⁾		14	V
V _{id}	Differential Input Voltage ⁽²⁾		±1	V
V _i	Input Voltage		V _{DD} -0.3 to V _{CC} +0.3	V
T _{stg}	Storage Temperature		-65 to +150	°C
T _j	Maximum Junction Temperature		150	°C
R _{thja}	Thermal Resistance Junction to Ambient	SO-8 TSSOP8 DIP8	125 120 85	°C/W
R _{thjc}	Thermal Resistance Junction to Case	SO-8 TSSOP8 DIP8	40 37 41	°C/W
ESD	Electro-Static Discharge	HBM Human Body Model ⁽³⁾	1.5	kV
		MM Machine Model ⁽⁴⁾	100	V
		CDM Charged Device Model	1.5	kV
	Output Short Circuit Duration		see note ⁽⁵⁾	
	Latch-up Immunity		200	mA
	Soldering Temperature	10sec, Standard package	250	°C
		10sec, Pb-free package	260	

- All voltage values, except differential voltage are with respect to network ground terminal.
- Differential voltages are the non-inverting input terminal with respect to the inverting input terminal. If V_{id} > ±1V, the maximum input current must not exceed ±1mA. In this case (V_{id} > ±1V) an input series resistor must be added to limit input current.
- Human body model, 100pF discharged through a 1.5kΩ resistor into pin of device.
- Machine model ESD, a 200pF cap is charged to the specified voltage, then discharged directly into the IC with no external series resistor (internal resistor < 5Ω), into pin to pin of device.
- There is no short-circuit protection inside the device: short-circuits from the output to V_{CC} can cause excessive heating. The maximum output current is approximately 80mA, independent of the magnitude of V_{CC}. Destructive dissipation can result from simultaneous short-circuits on all amplifiers.

Table 2. Operating conditions

Symbol	Parameter	Value	Unit
V _{CC}	Supply Voltage	2.7 to 12	V
V _{icm}	Common Mode Input Voltage Range	V _{DD} -0.2 to V _{CC} +0.2	V
T _{oper}	Operating Free Air Temperature Range	-40 to +125	°C

2 Electrical Characteristics

Table 3. Electrical characteristics for $V_{CC} = 3V$, $V_{DD} = 0V$, $V_{icm} = V_{CC}/2$, R_L connected to $V_{CC}/2$, $T_{amb} = 25^\circ C$ (unless otherwise specified)

Symbol	Parameter	Conditions	Min.	Typ.	Max.	Unit
V_{io}	Input Offset Voltage	at $T_{min.} \leq T_{amb} \leq T_{max}$			3 5	mV
DV_{io}	Input Offset Voltage Drift			2		$\mu V/^\circ C$
I_{io}	Input Offset Current	$V_{out} = 1.5V$		1	30	nA
I_{ib}	Input Bias Current	$V_{out} = 1.5V$		15	100	nA
V_{OH}	High Level Output Voltage	$R_L = 600\Omega$ $R_L = 32\Omega$	2.87	2.63		V
V_{OL}	Low Level Output Voltage	$R_L = 600\Omega$ $R_L = 32\Omega$		180	100	mV
A_{vd}	Large Signal Voltage Gain	$V_{out} = 2V_{pk-pk}$ $R_L = 600\Omega$ $R_L = 32\Omega$		35 16		V/mV
GBP	Gain Bandwidth Product	$R_L = 600\Omega$		4		MHz
I_{CC}	Supply Current	no load, $V_{out} = V_{CC}/2$		1	1.5	mA
CMR	Common Mode Rejection Ratio		60	80		dB
SVR	Supply Voltage Rejection Ratio	$V_{CC} = 2.7$ to $3.3V$	60	80		dB
I_o	Output Short-Circuit Current		50	80		mA
SR	Slew Rate		0.7	1.3		V/ μs
Pm	Phase Margin at Unit Gain	$R_L = 600\Omega$, $C_L = 100pF$		68		Degrees
GM	Gain Margin	$R_L = 600\Omega$, $C_L = 100pF$		12		dB
e_n	Equivalent Input Noise Voltage	$f = 1kHz$		9		$\frac{nV}{\sqrt{Hz}}$
THD	Total Harmonic Distortion	$V_{out} = 2V_{pk-pk}$, $f = 1kHz$, $A_v = 1$, $R_L = 600\Omega$		0.005		%

Table 4. Electrical characteristics for $V_{CC} = 5V$, $V_{DD} = 0V$, $V_{icm} = V_{CC}/2$, R_L connected to $V_{CC}/2$, $T_{amb} = 25^\circ C$ (unless otherwise specified)

Symbol	Parameter	Conditions	Min.	Typ.	Max.	Unit
V_{io}	Input Offset Voltage	at $T_{min.} \leq T_{amb} \leq T_{max}$			3 5	mV
DV_{io}	Input Offset Voltage Drift			2		$\mu V/^\circ C$
I_{io}	Input Offset Current	$V_{out} = 1.5V$		1	30	nA
I_{ib}	Input Bias Current	$V_{out} = 1.5V$		15	100	nA
V_{OH}	High Level Output Voltage	$R_L = 600\Omega$ $R_L = 32\Omega$	4.85	4.4		V
V_{OL}	Low Level Output Voltage	$R_L = 600\Omega$ $R_L = 32\Omega$		300	120	mV
A_{vd}	Large Signal Voltage Gain	$V_{out} = 2V_{pk-pk}$ $R_L = 600\Omega$ $R_L = 32\Omega$		35 16		V/mV
GBP	Gain Bandwidth Product	$R_L = 600\Omega$		4		MHz
I_{CC}	Supply Current	no load, $V_{out} = V_{CC}/2$		1	1.5	mA
CMR	Common Mode Rejection Ratio		60	80		dB
SVR	Supply Voltage Rejection Ratio	$V_{CC} = 4.5$ to $5.5V$	60	80		dB
I_o	Output Short-Circuit Current		50	80		mA
SR	Slew Rate		0.7	1.3		V/ μs
Pm	Phase Margin at Unit Gain	$R_L = 600\Omega$, $C_L = 100pF$		68		Degrees
GM	Gain Margin	$R_L = 600\Omega$, $C_L = 100pF$		12		dB
e_n	Equivalent Input Noise Voltage	$f = 1kHz$		9		$\frac{nV}{\sqrt{Hz}}$
THD	Total Harmonic Distortion	$V_{out} = 2V_{pk-pk}$, $f = 1kHz$, $A_v = 1$, $R_L = 600\Omega$		0.005		%

Figure 1. Output short circuit vs. output voltage

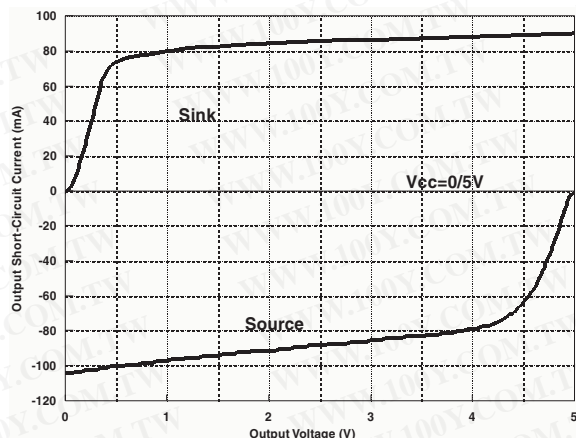

Figure 2. Voltage gain and phase vs. frequency

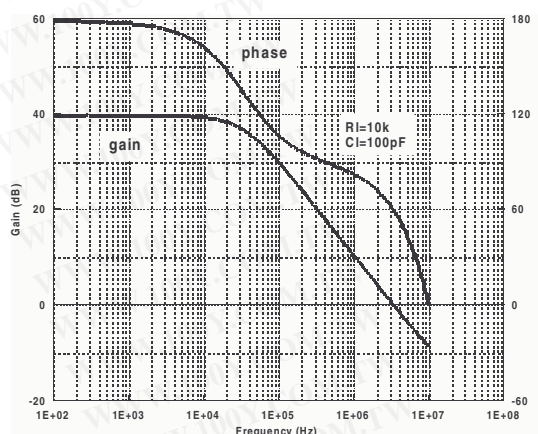

Figure 3. Output short circuit vs. output voltage

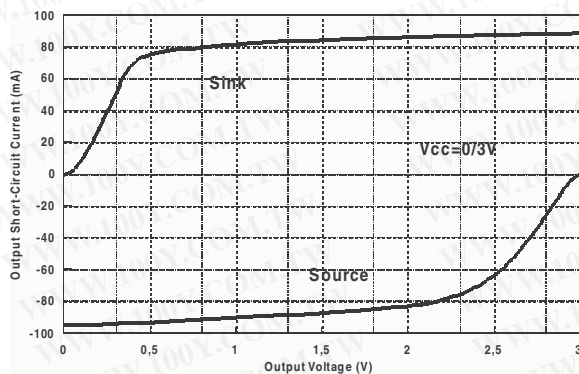

Figure 4. Equivalent input noise voltage vs. frequency

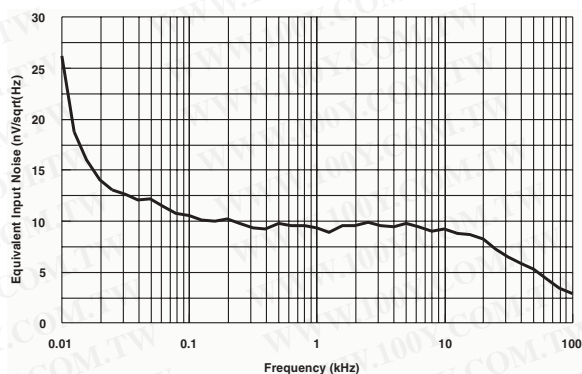

Figure 5. Output supply current vs. supply voltage

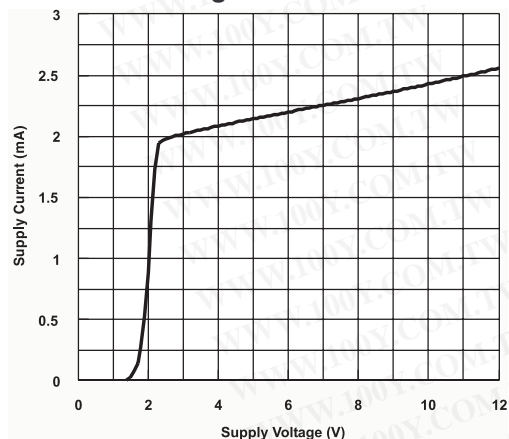

Figure 6. THD + noise vs. frequency

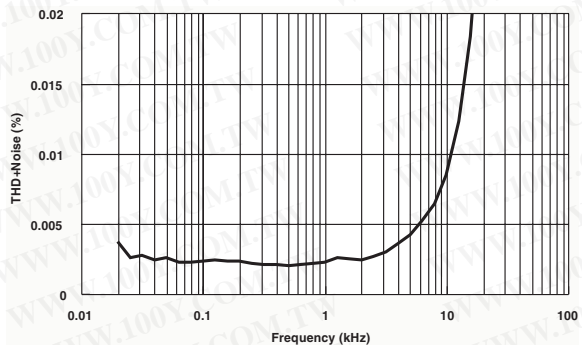

Figure 7. THD + noise vs. frequency

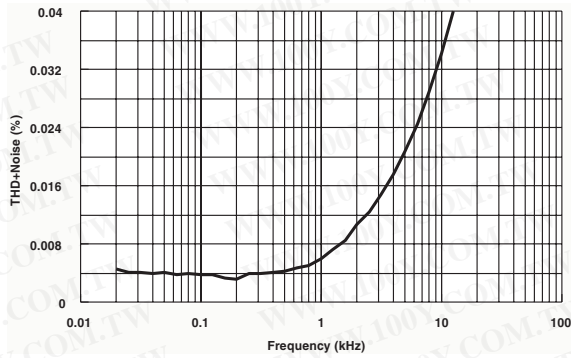

Figure 8. THD + noise vs. output voltage

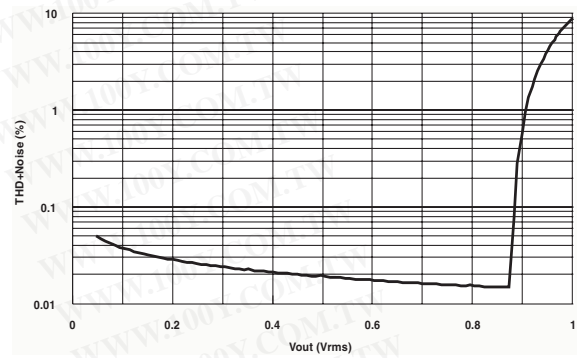

Figure 9. THD + noise vs. frequency

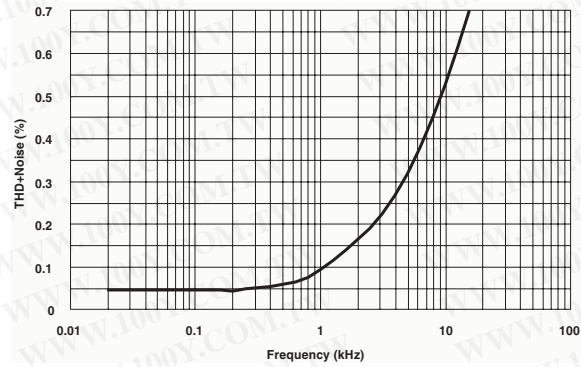

Figure 10. THD + noise vs. output voltage

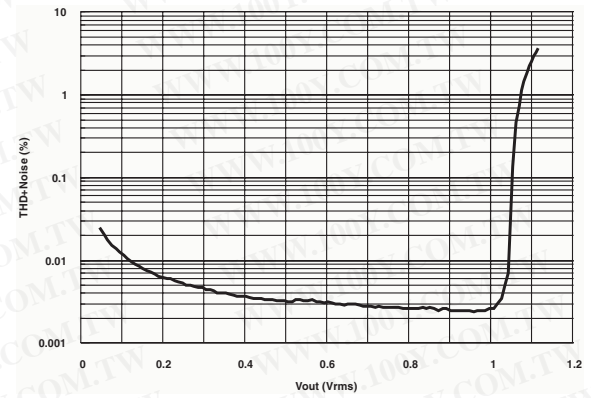

Figure 11. THD + noise vs. output voltage

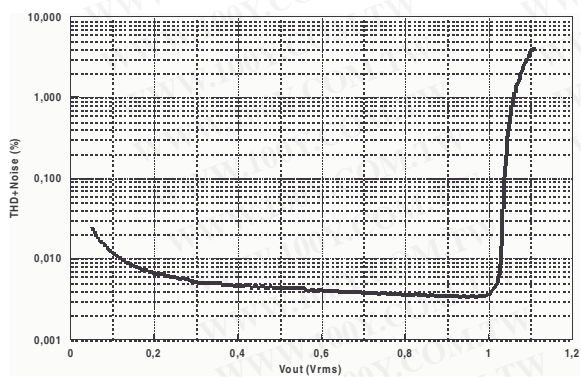
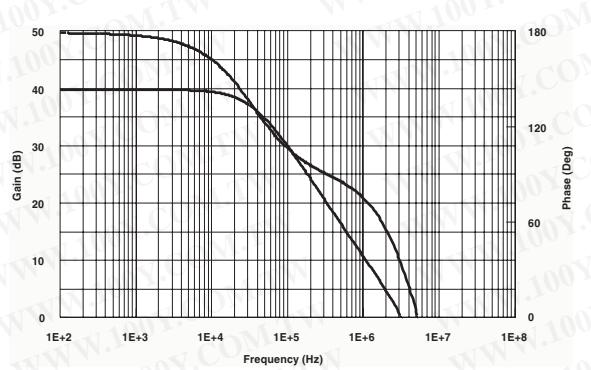

Figure 12. Open loop gain and phase vs. frequency



3 Macromodels

3.1 Important note concerning this macromodel

Please consider following remarks before using this macromodel:

- All models are a trade-off between accuracy and complexity (i.e. simulation time).
- Macromodels are not a substitute to breadboarding; rather, they confirm the validity of a design approach and help to select surrounding component values.
- A macromodel emulates the NOMINAL performance of a TYPICAL device within SPECIFIED OPERATING CONDITIONS (i.e. temperature, supply voltage, etc.). Thus the macromodel is often not as exhaustive as the datasheet, its goal is to illustrate the main parameters of the product.
- Data issued from macromodels used outside of its specified conditions (V_{CC} , Temperature, etc) or even worse: outside of the device operating conditions (V_{CC} , V_{icm} , etc) are not reliable in any way.

In *Section 3.3*, the electrical characteristics resulting from the use of these macromodels are presented.

3.2 Electrical characteristics from macromodelization

Table 5. Electrical characteristics resulting from macromodel simulation at $V_{CC} = 3V$, $V_{DD} = 0V$, R_L , C_L connected to $V_{CC/2}$, $T_{amb} = 25^\circ C$ (unless otherwise specified)

Symbol	Conditions	Value	Unit
V_{io}		0	mV
A_{vd}	$R_L = 10k\Omega$	200	V/mV
I_{CC}	No load, per operator	1.2	mA
V_{icm}		-0.2 to 3.2	V
V_{OH}	$R_L = 10k\Omega$	2.95	V
V_{OL}	$R_L = 10k\Omega$	25	mV
I_{sink}	$V_O = 3V$	80	mA
I_{source}	$V_O = 0V$	80	mA
GBP	$R_L = 600k\Omega$	4	MHz
SR	$R_L = 10k\Omega$, $C_L = 100pF$	1.3	V/ μs
ϕ_m	$R_L = 600k\Omega$	68	Degrees

3.3 Macromodel code

```

** Standard Linear Ics Macromodels, 1996.
** CONNECTIONS:
* 1 INVERTING INPUT
* 2 NON-INVERTING INPUT
* 3 OUTPUT
* 4 POSITIVE POWER SUPPLY
* 5 NEGATIVE POWER SUPPLY
.SUBCKT TS921 1 3 2 4 5 (analog)
*****.MODEL MDTH
D IS=1E-8 KF=2.664234E-16 CJO=10F
* INPUT STAGE
CIP 2 5 1.000000E-12
CIN 1 5 1.000000E-12
EIP 10 5 2 5 1
EIN 16 5 1 5 1
RIP 10 11 8.125000E+00
RIN 15 16 8.125000E+00
RIS 11 15 2.238465E+02
DIP 11 12 MDTH 400E-12
DIN 15 14 MDTH 400E-12
VOFP 12 13 DC 153.5u
VOFN 13 14 DC 0
IPOL 13 5 3.200000E-05
CPS 11 15 1e-9
DINN 17 13 MDTH 400E-12
VIN 17 5 -0.100000e+00
DINR 15 18 MDTH 400E-12
VIP 4 18 0.400000E+00
FCP 4 5 VOFP 1.865000E+02
FCN 5 4 VOFN 1.865000E+02
FIBP 2 5 VOFP 6.250000E-03
FIBN 5 1 VOFN 6.250000E-03
* GM1 STAGE *****
FGM1P 119 5 VOFP 1.1
FGM1N 119 5 VOFN 1.1
RAP 119 4 2.6E+06
RAN 119 5 2.6E+06
* GM2 STAGE *****
G2P 19 5 119 5 1.92E-02
G2N 19 5 119 4 1.92E-02
R2P 19 4 1E+07
R2N 19 5 1E+07
*****
VINT1 500 0 5
GCONVP 500 501 119 4 19.38!send ds VP, I(VP)=(V119-V4)/2/Ut VP 501 0 0
GCONVN 500 502 119 5 19.38!send ds VN, I(VN)=(V119-V5)/2/Ut VN 502 0 0
***** orientation isink isource *****
VINT2 503 0 5
FCOPY 503 504 VOUT 1
DCOPYP 504 505 MDTH 400E-9
    
```

```

VCOPYP 505 0 0
DCOPYN 506 504 MDTH 400E-9
VCOPYN 0 506 0
*****
F2PP 19 5 poly(2) VCOYP VP 0 0 0 0 0.5!multiply
I(vout)*I(VP)=Iout*(V119-V4)/2/Ut
F2PN 19 5 poly(2) VCOYP VN 0 0 0 0 0.5 !multiply
I(vout)*I(VN)=Iout*(V119-V5)/2/Ut
F2NP 19 5 poly(2) VCOPYN VP 0 0 0 0 1.75 !multiply
I(vout)*I(VP)=Iout*(V119-V4)/2/Ut
F2NN 19 5 poly(2) VCOPYN VN 0 0 0 0 1.75 !multiply
I(vout)*I(VN)=Iout*(V119-V5)/2/Ut
* COMPENSATION *****
CC 19 119 25p
* OUTPUT*****
DOPM 19 22 MDTH 400E-12
DONM 21 19 MDTH 400E-12
HOPM 22 28 VOUT 6.250000E+02
VIPM 28 4 5.000000E+01
HONM 21 27 VOUT 6.250000E+02
VINM 5 27 5.000000E+01
VOUT 3 23 0
ROUT 23 19 6
COUT 3 5 1.300000E-10
DOP 19 25 MDTH 400E-12
VOP 4 25 1.052
DON 24 19 MDTH 400E-12
VON 24 5 1.052
.ENDS

```

4 Package Mechanical Data

In order to meet environmental requirements, ST offers these devices in ECOPACK[®] packages. These packages have a Lead-free second level interconnect. The category of second level interconnect is marked on the package and on the inner box label, in compliance with JEDEC Standard JESD97. The maximum ratings related to soldering conditions are also marked on the inner box label. ECOPACK is an ST trademark. ECOPACK specifications are available at: www.st.com.

4.1 DIP8 Package

Plastic DIP-8 MECHANICAL DATA

DIM.	mm.			inch		
	MIN.	TYP.	MAX.	MIN.	TYP.	MAX.
A		3.3			0.130	
a1	0.7			0.028		
B	1.39		1.65	0.055		0.065
B1	0.91		1.04	0.036		0.041
b		0.5			0.020	
b1	0.38		0.5	0.015		0.020
D			9.8			0.386
E		8.8			0.346	
e		2.54			0.100	
e3		7.62			0.300	
e4		7.62			0.300	
F			7.1			0.280
I			4.8			0.189
L		3.3			0.130	
Z	0.44		1.6	0.017		0.063

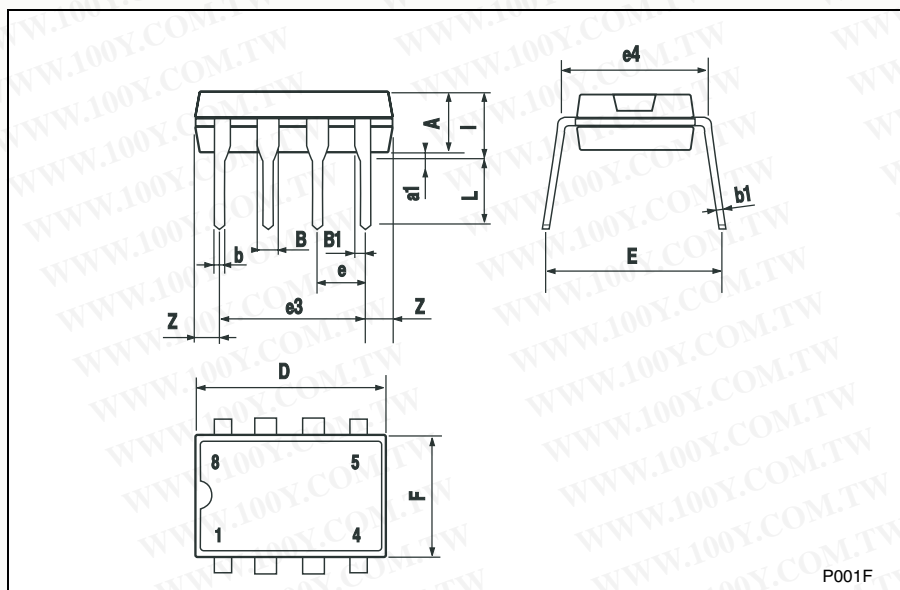

P001F

4.2 SO-8 Package

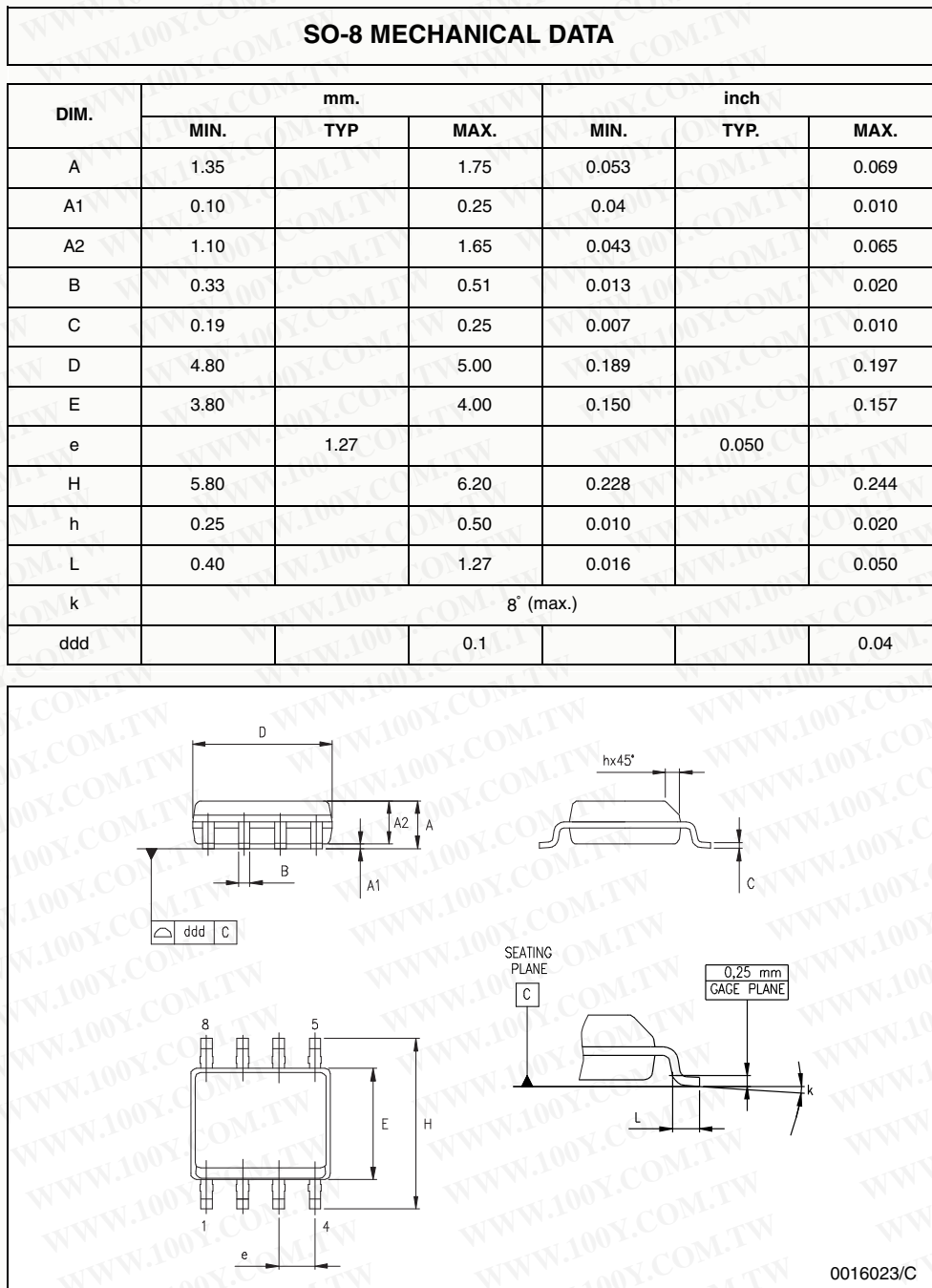

4.3 TSSOP8 Package

TSSOP8 MECHANICAL DATA						
DIM.	mm.			inch		
	MIN.	TYP	MAX.	MIN.	TYP.	MAX.
A			1.2			0.047
A1	0.05		0.15	0.002		0.006
A2	0.80	1.00	1.05	0.031	0.039	0.041
b	0.19		0.30	0.007		0.012
c	0.09		0.20	0.004		0.008
D	2.90	3.00	3.10	0.114	0.118	0.122
E	6.20	6.40	6.60	0.244	0.252	0.260
E1	4.30	4.40	4.50	0.169	0.173	0.177
e		0.65			0.0256	
K	0°		8°	0°		8°
L	0.45	0.60	0.75	0.018	0.024	0.030
L1		1			0.039	

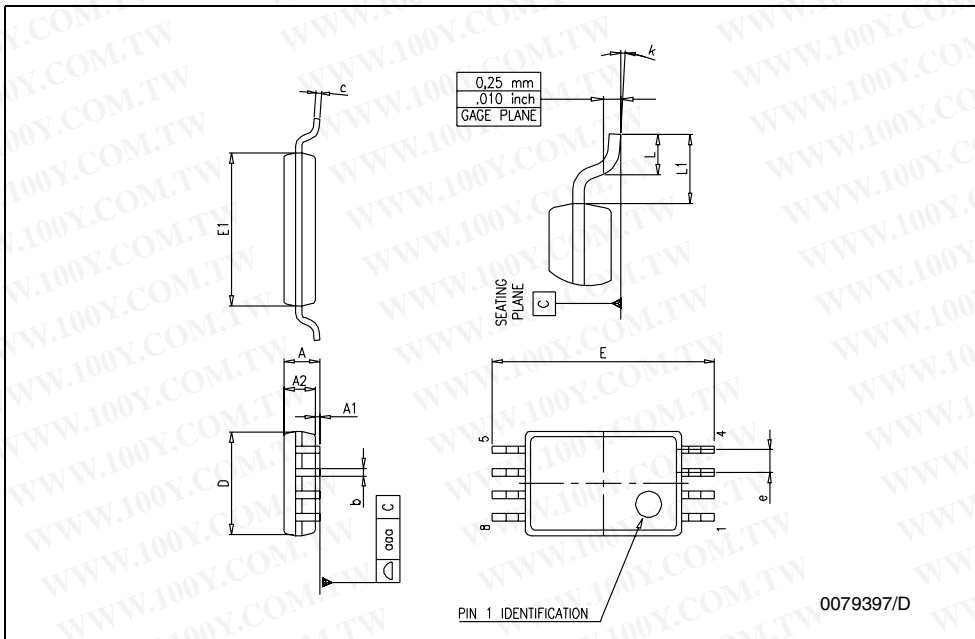

5 Revision History

勝特力材料 886-3-5753170
 勝特力电子(上海) 86-21-34970699
 勝特力电子(深圳) 86-755-83298787
[Http://www.100y.com.tw](http://www.100y.com.tw)

Date	Revision	Changes
Feb. 2001	1	Initial release - Product in full production.
Dec. 2004	2	Modifications on AMR table page 2 (explanation of Vid and Vi limits, ESD MM and CDM values added, Rthja added)
Nov. 2005	3	The following changes were made in this revision: – PPAP references inserted in the datasheet see <i>Table . Order Codes on page 2.</i> – Data in tables <i>Electrical Characteristics on page 4</i> reformatted for easier use. – Thermal Resistance Junction to Case added in <i>Table 1. on page 3.</i>

Information furnished is believed to be accurate and reliable. However, STMicroelectronics assumes no responsibility for the consequences of use of such information nor for any infringement of patents or other rights of third parties which may result from its use. No license is granted by implication or otherwise under any patent or patent rights of STMicroelectronics. Specifications mentioned in this publication are subject to change without notice. This publication supersedes and replaces all information previously supplied. STMicroelectronics products are not authorized for use as critical components in life support devices or systems without express written approval of STMicroelectronics.

The ST logo is a registered trademark of STMicroelectronics.
 All other names are the property of their respective owners

© 2005 STMicroelectronics - All rights reserved

STMicroelectronics group of companies

Australia - Belgium - Brazil - Canada - China - Czech Republic - Finland - France - Germany - Hong Kong - India - Israel - Italy - Japan - Malaysia - Malta - Morocco - Singapore - Spain - Sweden - Switzerland - United Kingdom - United States of America

www.st.com