



勝特力材料 886-3-5753170
勝特力电子(上海) 86-21-34970699
勝特力电子(深圳) 86-755-83298787
Http://www.100y.com.tw

TSV639x, TSV639xA

Micropower (60 μ A), wide bandwidth (2.4 MHz) CMOS op-amps

Features

- Rail-to-rail input and output
- Low power consumption: 60 μ A typ at 5 V
- Low supply voltage: 1.5 V - 5.5 V
- Gain bandwidth product: 2.4 MHz typ, stable for gain equal or above -3 or +4
- Low power shutdown mode: 5 nA typ
- Low offset voltage: 800 μ V max (A version)
- Low input bias current: 1 pA typ
- EMI hardened operational amplifiers
- High tolerance to ESD: 4 kV HBM
- Extended temperature range: -40° C to +125° C

Applications

- Battery-powered applications
- Portable devices
- Signal conditioning
- Active filtering
- Medical instrumentation

Description

The TSV639x series of dual and quad operational amplifiers offers low voltage operation and rail-to-rail input and output.

For applications configured with gain, the TSV639x series offers an excellent speed/power consumption ratio, 2.4 MHz gain bandwidth product while consuming only 60 μ A at 5 V. The devices also feature an ultra-low input bias current and have a shutdown mode (TSV6393, TSV6395).

These features make the TSV639x family ideal for sensor interfaces, battery supplied and portable applications, as well as active filtering.

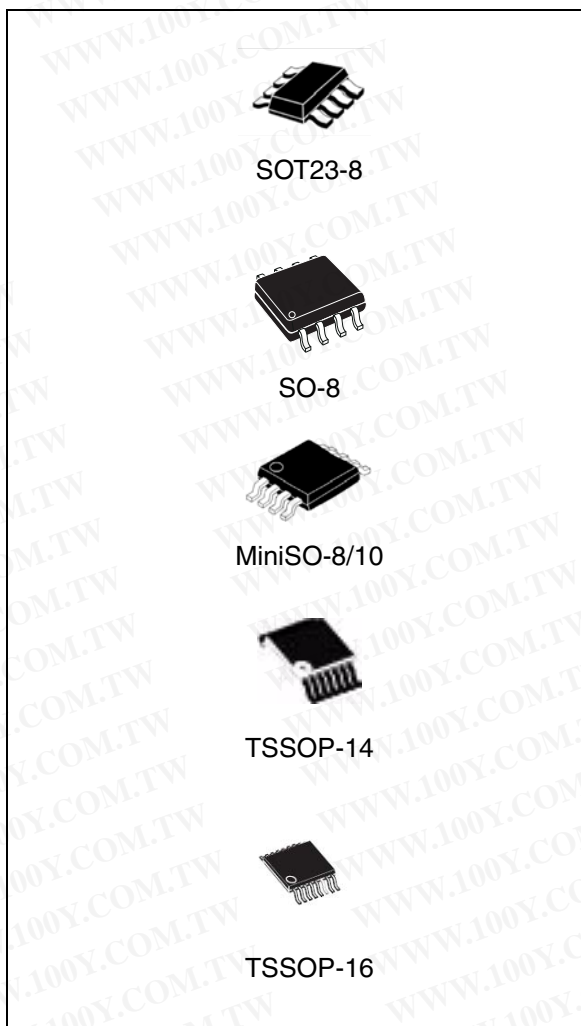

Table 1. Device summary

Reference	Dual version		Quad version	
	Without standby	With standby	Without standby	With standby
TSV639x	TSV6392	TSV6393	TSV6394	TSV6395
TSV639xA	TSV6392A	TSV6393A	TSV6394A	TSV6395A

Contents

1	Package pin connections	3
2	Absolute maximum ratings and operating conditions	4
3	Electrical characteristics	5
4	Application information	13
4.1	Operating voltages	13
4.2	Rail-to-rail input	13
4.3	Rail-to-rail output	13
4.4	Shutdown function (TSV6393 - TSV6395)	13
4.5	Optimization of DC and AC parameters	15
4.6	Driving resistive and capacitive loads	15
4.7	PCB layouts	15
4.8	Macromodel	15
5	Package information	16
5.1	SOT23-8 package information	17
5.2	SO-8 package information	18
5.3	MiniSO-8 package information	19
5.4	MiniSO-10 package information	20
5.5	TSSOP14 package information	21
5.6	TSSOP16 package information	22
6	Ordering information	23
7	Revision history	24

1 Package pin connections

Figure 1. Pin connections for each package (top view)

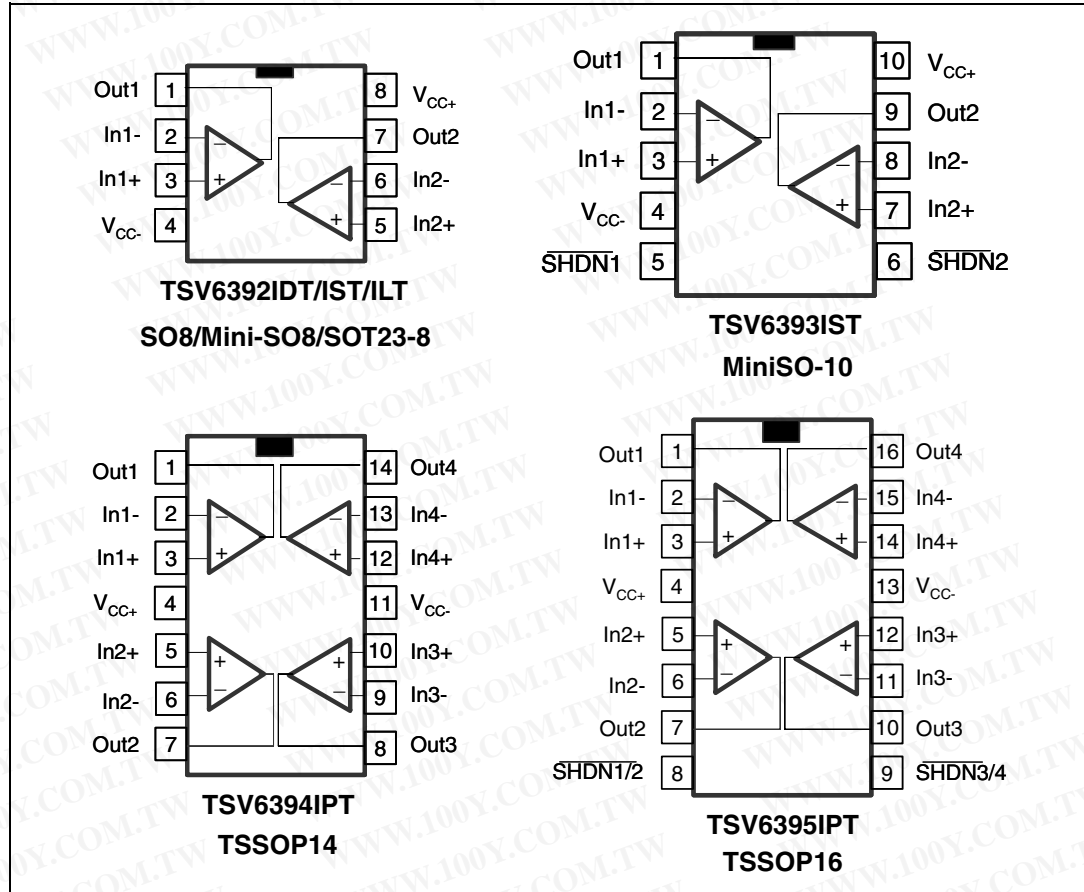

2 Absolute maximum ratings and operating conditions

Table 2. Absolute maximum ratings (AMR)

Symbol	Parameter	Value	Unit
V_{CC}	Supply voltage ⁽¹⁾	6	V
V_{id}	Differential input voltage ⁽²⁾	$\pm V_{CC}$	V
V_{in}	Input voltage ⁽³⁾	$V_{CC-} - 0.2$ to $V_{CC+} + 0.2$	V
I_{in}	Input current ⁽⁴⁾	10	mA
\overline{SHDN}	Shutdown voltage ⁽³⁾	$V_{CC-} - 0.2$ to $V_{CC+} + 0.2$	V
T_{stg}	Storage temperature	-65 to +150	°C
R_{thja}	Thermal resistance junction to ambient ⁽⁵⁾⁽⁶⁾		°C/W
	SOT23-8	105	
	MiniSO-8	190	
	SO-8	125	
	MiniSO-10	113	
	TSSOP14	100	
	TSSOP16	95	
T_j	Maximum junction temperature	150	°C
ESD	HBM: human body model ⁽⁷⁾	4	kV
	MM: machine model ⁽⁸⁾	300	V
	CDM: charged device model ⁽⁹⁾	1.5	kV
	Latch-up immunity	200	mA

- All voltage values, except differential voltage are with respect to network ground terminal.
- Differential voltages are the non-inverting input terminal with respect to the inverting input terminal.
- $V_{CC-} - V_{in}$ must not exceed 6 V, V_{in} must not exceed 6V.
- Input current must be limited by a resistor in series with the inputs.
- Short-circuits can cause excessive heating and destructive dissipation.
- R_{th} are typical values.
- Human body model: 100 pF discharged through a 1.5 k Ω resistor between two pins of the device, done for all couples of pin combinations with other pins floating.
- Machine model: a 200 pF cap is charged to the specified voltage, then discharged directly between two pins of the device with no external series resistor (internal resistor < 5 Ω), done for all couples of pin combinations with other pins floating.
- Charged device model: all pins plus package are charged together to the specified voltage and then discharged directly to the ground.

Table 3. Operating conditions

Symbol	Parameter	Value	Unit
V_{CC}	Supply voltage	1.5 to 5.5	V
V_{icm}	Common mode input voltage range	$V_{CC-} - 0.1$ to $V_{CC+} + 0.1$	V
T_{oper}	Operating free air temperature range	-40 to +125	°C

3 Electrical characteristics

Table 4. Electrical characteristics at $V_{CC+} = +1.8\text{ V}$ with $V_{CC-} = 0\text{ V}$, $V_{icm} = V_{CC}/2$, $T_{amb} = 25^\circ\text{ C}$, and R_L connected to $V_{CC}/2$ (unless otherwise specified)

Symbol	Parameter	Conditions	Min.	Typ.	Max.	Unit
DC performance						
V_{io}	Offset voltage	TSV639x TSV639xA TSV6393AIST - MiniSO-10			3 0.8 1	mV
		$T_{min} < T_{op} < T_{max}$ - TSV639x $T_{min} < T_{op} < T_{max}$ - TSV639xA $T_{min} < T_{op} < T_{max}$ - TSV6393AIST			4.5 2 2.2	mV
DV_{io}	Input offset voltage drift			2		$\mu\text{V}/^\circ\text{C}$
I_{io}	Input offset current ($V_{out} = V_{CC}/2$)			1	$10^{(1)}$	pA
		$T_{min} < T_{op} < T_{max}$		1	100	pA
I_{ib}	Input bias current ($V_{out} = V_{CC}/2$)			1	$10^{(1)}$	pA
		$T_{min} < T_{op} < T_{max}$		1	100	pA
CMR	Common mode rejection ratio $20 \log(\Delta V_{ic}/\Delta V_{io})$	0 V to 1.8 V, $V_{out} = 0.9\text{ V}$	53	74		dB
		$T_{min} < T_{op} < T_{max}$	51			dB
A_{vd}	Large signal voltage gain	$R_L = 10\text{ k}\Omega$, $V_{out} = 0.5\text{ V}$ to 1.3 V	85	95		dB
		$T_{min} < T_{op} < T_{max}$	80			dB
V_{OH}	High level output voltage	$R_L = 10\text{ k}\Omega$ $T_{min} < T_{op} < T_{max}$	35 50	5		mV
V_{OL}	Low level output voltage	$R_L = 10\text{ k}\Omega$ $T_{min} < T_{op} < T_{max}$		4	35 50	mV
I_{out}	I_{sink}	$V_o = 1.8\text{ V}$	6	12		mA
		$T_{min} < T_{op} < T_{max}$	4			
	I_{source}	$V_o = 0\text{ V}$	6	10		mA
		$T_{min} < T_{op} < T_{max}$	4			
I_{CC}	Supply current (per operator)	No load, $V_{out} = V_{CC}/2$	40	50	60	μA
		$T_{min} < T_{op} < T_{max}$			62	μA
AC performance						
GBP	Gain bandwidth product	$R_L = 10\text{ k}\Omega$, $C_L = 100\text{ pF}$		2		MHz
Gain	Minimum gain for stability	Phase margin = 60° , $R_f = 10\text{ k}\Omega$, $R_L = 10\text{ k}\Omega$, $C_L = 20\text{ pF}$		+4 -3		V/V
SR	Slew rate	$R_L = 10\text{ k}\Omega$, $C_L = 100\text{ pF}$, $V_{out} = 0.5\text{ V}$ to 1.3 V		0.7		V/ μs
e_n	Equivalent input noise voltage	$f = 1\text{ kHz}$		60		$\frac{\text{nV}}{\sqrt{\text{Hz}}}$
		$f = 10\text{ kHz}$		33		

1. Guaranteed by design.

Table 5. Shutdown characteristics $V_{CC} = 1.8\text{ V}$

Symbol	Parameter	Conditions	Min.	Typ.	Max.	Unit
DC performance						
I_{CC}	Supply current in shutdown mode (all operators)	$\overline{\text{SHDN}} = V_{CC-}$		2.5	50	nA
		$T_{\min} < T_{\text{op}} < 85^\circ\text{C}$			200	nA
		$T_{\min} < T_{\text{op}} < 125^\circ\text{C}$				1.5
t_{on}	Amplifier turn-on time	$R_L = 2\text{ k}\Omega$ $V_{\text{out}} = V_{CC-}$ to $V_{CC+0.2}\text{ V}$		200		ns
t_{off}	Amplifier turn-off time	$R_L = 2\text{ k}\Omega$ $V_{\text{out}} = V_{CC+} - 0.5\text{ V}$ to $V_{CC+} - 0.7\text{ V}$		20		ns
V_{IH}	$\overline{\text{SHDN}}$ logic high		1.35			V
V_{IL}	$\overline{\text{SHDN}}$ logic low				0.6	V
I_{IH}	$\overline{\text{SHDN}}$ current high	$\overline{\text{SHDN}} = V_{CC+}$		10		μA
I_{IL}	$\overline{\text{SHDN}}$ current low	$\overline{\text{SHDN}} = V_{CC-}$		10		μA
I_{OLeak}	Output leakage in shutdown mode	$\overline{\text{SHDN}} = V_{CC-}$		50		μA
		$T_{\min} < T_{\text{op}} < 125^\circ\text{C}$		1		nA

Table 6. $V_{CC+} = +3.3\text{ V}$, $V_{CC-} = 0\text{ V}$, $V_{icm} = V_{CC}/2$, $T_{amb} = 25^\circ\text{ C}$, R_L connected to $V_{CC}/2$ (unless otherwise specified)

Symbol	Parameter	Conditions	Min.	Typ.	Max.	Unit
DC performance						
V_{io}	Offset voltage	TSV639x			3	mV
		TSV639xA			0.8	
		TSV6393AIST - MiniSO10			1	
		$T_{min} < T_{op} < T_{max}$ - TSV639x			4.5	mV
		$T_{min} < T_{op} < T_{max}$ - TSV639xA			2	
		$T_{min} < T_{op} < T_{max}$ - TSV6393AIST			2.2	
DV_{io}	Input offset voltage drift			2		$\mu\text{V}/^\circ\text{C}$
I_{io}	Input offset current			1	$10^{(1)}$	pA
		$T_{min} < T_{op} < T_{max}$		1	100	pA
I_{ib}	Input bias current			1	$10^{(1)}$	pA
		$T_{min} < T_{op} < T_{max}$		1	100	pA
CMR	Common mode rejection ratio $20 \log (\Delta V_{ic}/\Delta V_{io})$	0 V to 3.3 V, $V_{out} = 1.65\text{ V}$	57	79		dB
		$T_{min} < T_{op} < T_{max}$	53			
A_{vd}	Large signal voltage gain	$R_L = 10\text{ k}\Omega$, $V_{out} = 0.5\text{ V to } 2.8\text{ V}$	88	98		dB
		$T_{min} < T_{op} < T_{max}$	83			
V_{OH}	High level output voltage	$R_L = 10\text{ k}\Omega$ $T_{mi.} < T_{op} < T_{max}$	35 50	6		mV
V_{OL}	Low level output voltage	$R_L = 10\text{ k}\Omega$ $T_{min} < T_{op} < T_{max}$		7	35 50	mV
I_{out}	I_{sink}	$V_o = 3.3\text{ V}$	23	45		mA
		$T_{min} < T_{op} < T_{max}$	20			
	I_{source}	$V_o = 0\text{ V}$	23	38		mA
		$T_{min} < T_{op} < T_{max}$	20			
I_{CC}	Supply current (per operator)	No load, $V_{out} = 1.75\text{ V}$	43	55	64	μA
		$T_{min} < T_{op} < T_{max}$			66	μA
AC performance						
GBP	Gain bandwidth product	$R_L = 10\text{ k}\Omega$, $C_L = 100\text{ pF}$		2.2		MHz
Gain	Minimum gain for stability	Phase margin = 60° , $R_f = 10\text{ k}\Omega$, $R_L = 10\text{ k}\Omega$, $C_L = 20\text{ pF}$		+4 -3		V/V
SR	Slew rate	$R_L = 10\text{ k}\Omega$, $C_L = 100\text{ pF}$, $V_{out} = 0.5\text{ V to } 2.8\text{ V}$		0.9		V/ μs

1. Guaranteed by design.

Table 7. Electrical characteristics at $V_{CC+} = +5\text{ V}$ with $V_{CC-} = 0\text{ V}$, $V_{icm} = V_{CC}/2$, $T_{amb} = 25^\circ\text{ C}$, and R_L connected to $V_{CC}/2$ (unless otherwise specified)

Symbol	Parameter	Conditions	Min.	Typ.	Max.	Unit
DC performance						
V_{io}	Offset voltages	TSV639x TSV639xA TSV6393AIST - MiniSO10			3 0.8 1	mV
		$T_{min} < T_{op} < T_{max}$ - TSV639x $T_{min} < T_{op} < T_{max}$ - TSV639xA $T_{min} < T_{op} < T_{max}$ - TSV6393AIST			4.5 2 2.2	mV
DV_{io}	Input offset voltage drift			2		$\mu\text{V}/^\circ\text{C}$
I_{io}	Input offset current ($V_{out} = V_{CC}/2$)			1	$10^{(1)}$	pA
		$T_{min} < T_{op} < T_{max}$		1	100	pA
I_{ib}	Input bias current ($V_{out} = V_{CC}/2$)			1	$10^{(1)}$	pA
		$T_{min} < T_{op} < T_{max}$		1	100	pA
CMR	Common mode rejection ratio $20 \log (\Delta V_{ic}/\Delta V_{io})$	0 V to 5 V, $V_{out} = 2.5\text{ V}$	60	80		dB
		$T_{min} < T_{op} < T_{max}$	55			dB
SVR	Supply voltage rejection ratio $20 \log (\Delta V_{CC}/\Delta V_{io})$	$V_{CC} = 1.8\text{ to }5\text{ V}$	75	93		dB
		$T_{min} < T_{op} < T_{max}$	73			
A_{vd}	Large signal voltage gain	$R_L = 10\text{ k}\Omega$, $V_{out} = 0.5\text{ V to }4.5\text{ V}$	89	98		dB
		$T_{min} < T_{op} < T_{max}$	84			dB
EMIRR	EMI Rejection Ratio EMIRR = $-20 \log (V_{RFpeak}/\Delta V_{io})$	$V_{RF} = 100\text{ mV}_{rms}$, $f = 400\text{ MHz}$		61		dB
		$V_{RF} = 100\text{ mV}_{rms}$, $f = 900\text{ MHz}$		85		
		$V_{RF} = 100\text{ mV}_{rms}$, $f = 1800\text{ MHz}$		92		
		$V_{RF} = 100\text{ mV}_{rms}$, $f = 2400\text{ MHz}$		83		
V_{OH}	High level output voltage	$R_L = 10\text{ k}\Omega$ $T_{min} < T_{op} < T_{max}$	35 50	7		mV
V_{OL}	Low level output voltage	$R_L = 10\text{ k}\Omega$ $T_{min} < T_{op} < T_{max}$		6	35 50	mV
I_{out}	I_{sink}	$V_o = 5\text{ V}$	40	65		mA
		$T_{min} < T_{op} < T_{max}$	35			
	I_{source}	$V_o = 0\text{ V}$	40	72		mA
		$T_{min} < T_{op} < T_{max}$	35			
I_{CC}	Supply current (per operator)	No load, $V_{out} = V_{CC}/2$	50	60	69	μA
		$T_{min} < T_{op} < T_{max}$			72	μA

Table 7. Electrical characteristics at $V_{CC+} = +5\text{ V}$ with $V_{CC-} = 0\text{ V}$, $V_{icm} = V_{CC}/2$, $T_{amb} = 25^\circ\text{ C}$, and R_L connected to $V_{CC}/2$ (unless otherwise specified) (continued)

Symbol	Parameter	Conditions	Min.	Typ.	Max.	Unit
AC performance						
GBP	Gain bandwidth product	$R_L = 10\text{ k}\Omega$, $C_L = 100\text{ pF}$		2.4		MHz
Gain	Minimum gain for stability	Phase margin = 60° , $R_f = 10\text{ k}\Omega$, $R_L = 10\text{ k}\Omega$, $C_L = 20\text{ pF}$,		+4 -3		V/V
SR	Slew rate	$R_L = 10\text{ k}\Omega$, $C_L = 100\text{ pF}$		1.1		V/ μs
e_n	Equivalent input noise voltage	$f = 1\text{ kHz}$ $f = 10\text{ kHz}$		60 33		$\frac{\text{nV}}{\sqrt{\text{Hz}}}$
THD+N	Total harmonic distortion + noise	$V_{CC} = 5\text{ V}$, $f_{in} = 1\text{ kHz}$, $A_{CL} = -10$, $R_L = 100\text{ k}\Omega$, $V_{icm} = V_{CC}/2$, $BW = 22\text{ kHz}$, $V_{out} = 1\text{ V}_{rms}$		0.015		%

1. Guaranteed by design.

Table 8. Shutdown characteristics at $V_{CC} = 5\text{ V}$

Symbol	Parameter	Conditions	Min.	Typ.	Max.	Unit
DC performance						
I_{CC}	Supply current in shutdown mode (all operators)	$\overline{\text{SHDN}} = V_{CC-}$		5	50	nA
		$T_{min} < T_{op} < 85^\circ\text{ C}$			200	nA
		$T_{min} < T_{op} < 125^\circ\text{ C}$			1.5	μA
t_{on}	Amplifier turn-on time	$R_L = 2\text{ k}\Omega$, $V_{out} = V_{CC-} - \text{V to } V_{CC-} + 0.2\text{ V}$		200		ns
t_{off}	Amplifier turn-off time	$R_L = 2\text{ k}\Omega$, $V_{out} = V_{CC+} - 0.5\text{ V to } V_{CC+} - 0.7\text{ V}$		20		ns
V_{IH}	$\overline{\text{SHDN}}$ logic high		2			V
V_{IL}	$\overline{\text{SHDN}}$ logic low				0.8	V
I_{IH}	$\overline{\text{SHDN}}$ current high	$\overline{\text{SHDN}} = V_{CC+}$		10		pA
I_{IL}	$\overline{\text{SHDN}}$ current low	$\overline{\text{SHDN}} = V_{CC-}$		10		pA
I_{OLeak}	Output leakage in shutdown mode	$\overline{\text{SHDN}} = V_{CC-}$		50		pA
		$T_{min} < T_{op} < 125^\circ\text{ C}$		1		nA

Figure 2. Supply current vs. supply voltage at $V_{icm} = V_{CC}/2$

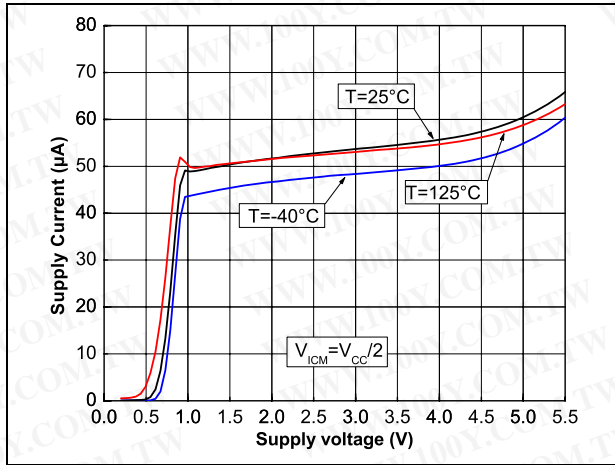

Figure 3. Output current vs. output voltage at $V_{CC} = 1.5 V$

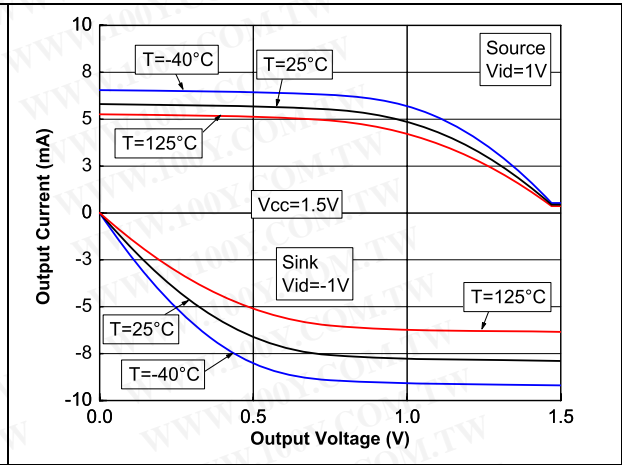

Figure 4. Output current vs. output voltage at $V_{CC} = 5 V$

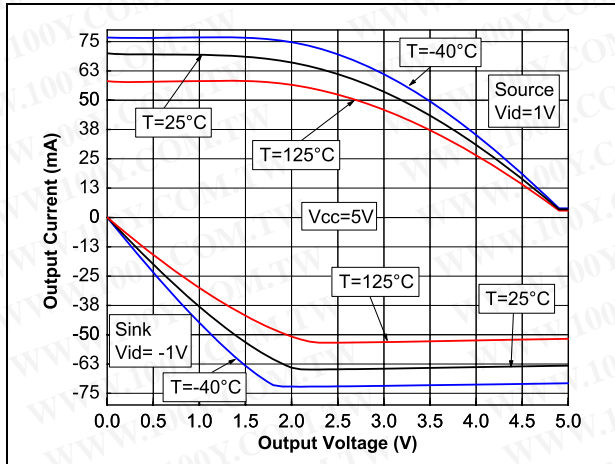

Figure 5. Closed loop response for gain = -10, at $V_{CC} = 1.5 V$ and $V_{CC} = 5 V$

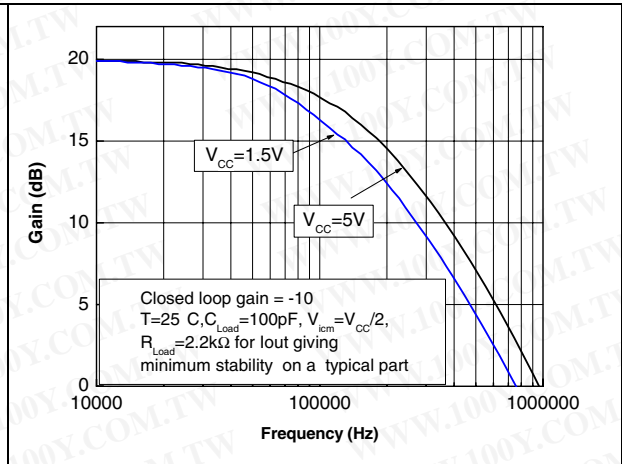

Figure 6. Closed loop response for gain = -3 at $V_{CC} = 1.5 V$

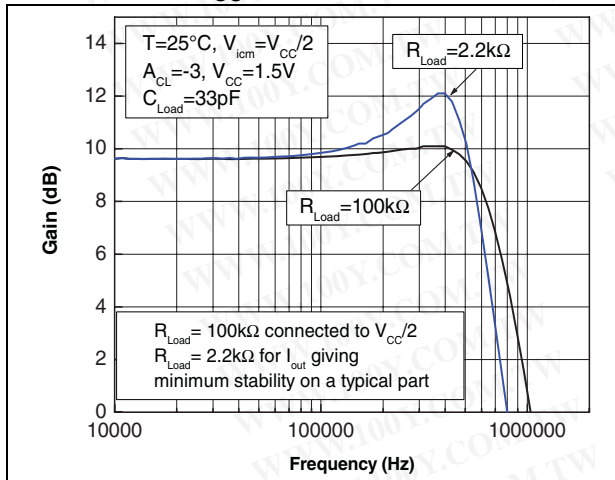

Figure 7. Closed loop response for gain = -3 at $V_{CC} = 5 V$

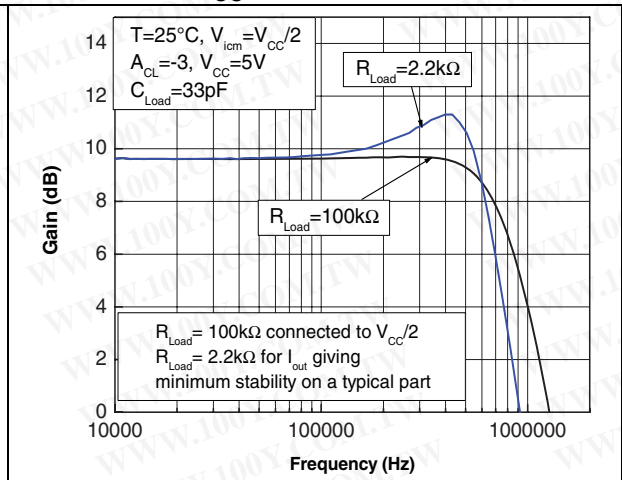

Figure 8. Positive slew rate vs. supply voltage in closed loop

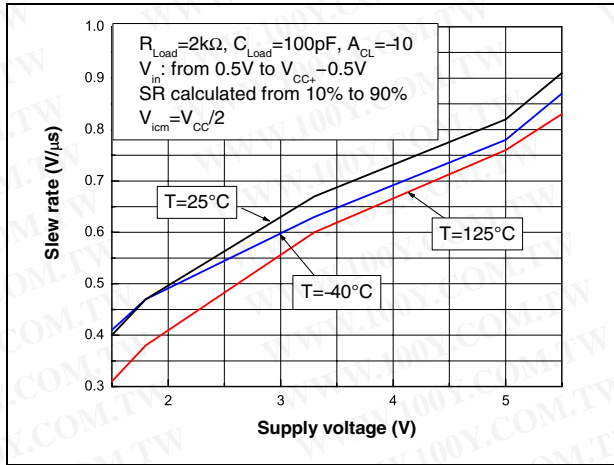

Figure 9. Negative slew rate vs. supply voltage in closed loop

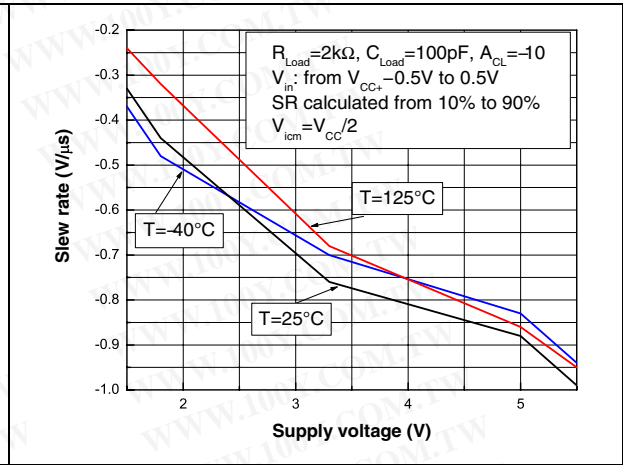

Figure 10. Slew rate vs. supply voltage in open loop

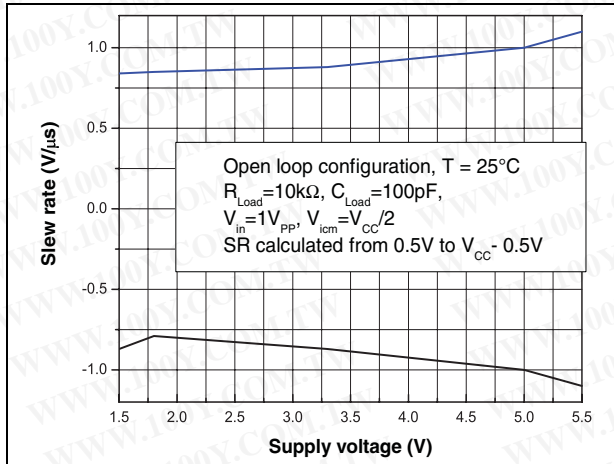

Figure 11. Slew rate timing in open loop

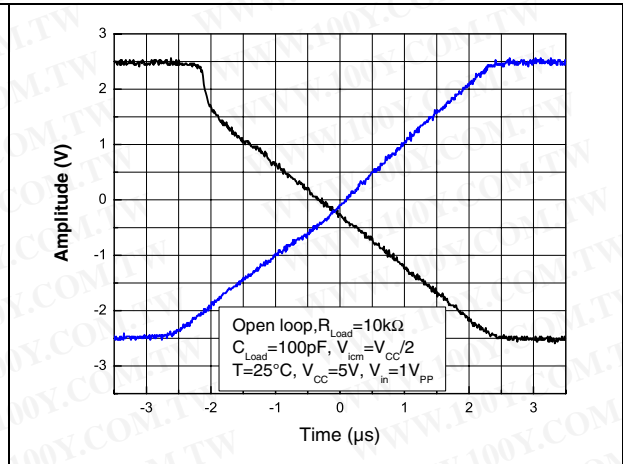

Figure 12. Slew rate timing in closed loop

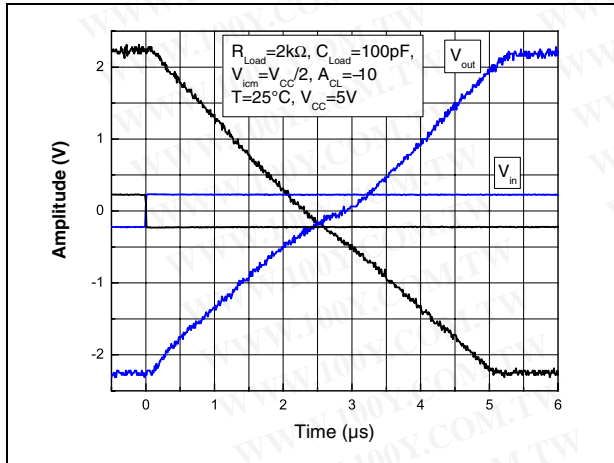

Figure 13. Noise vs. frequency

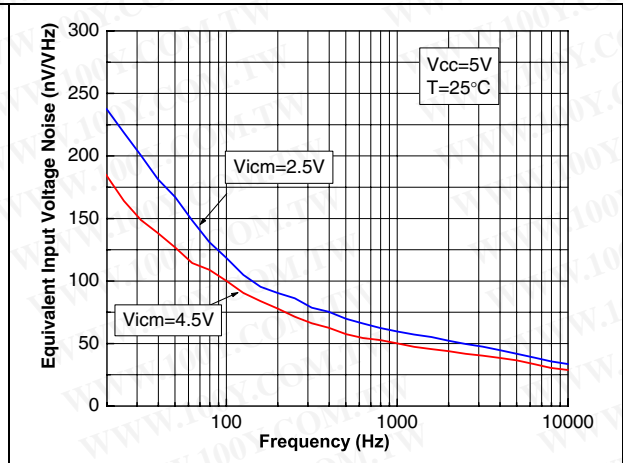

Figure 14. Distortion + noise vs. output voltage at $V_{CC} = 1.8\text{ V}$

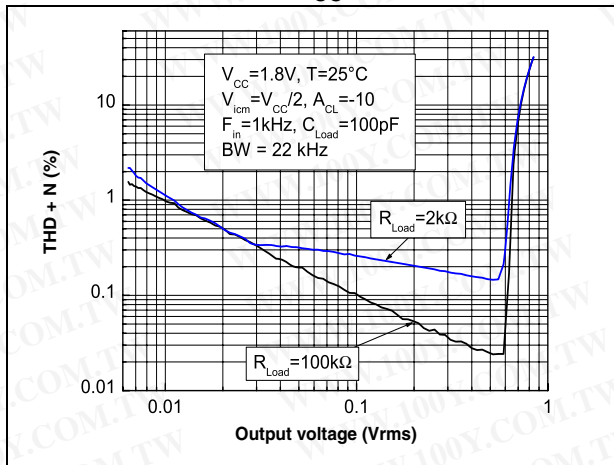

Figure 15. Distortion + noise vs. frequency at $V_{CC} = 1.8\text{ V}$

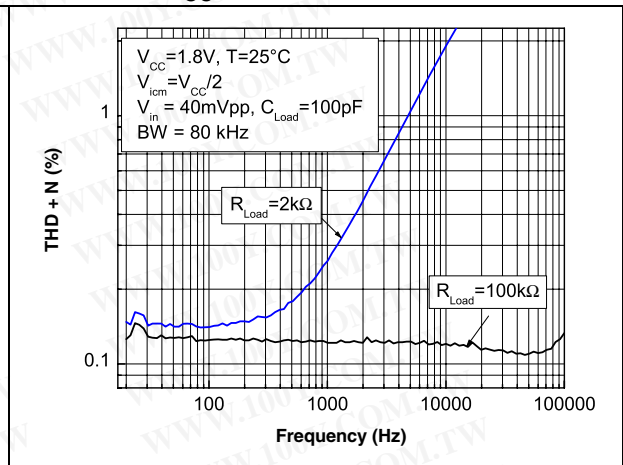

Figure 16. Distortion + noise vs. output voltage at $V_{CC} = 5\text{ V}$

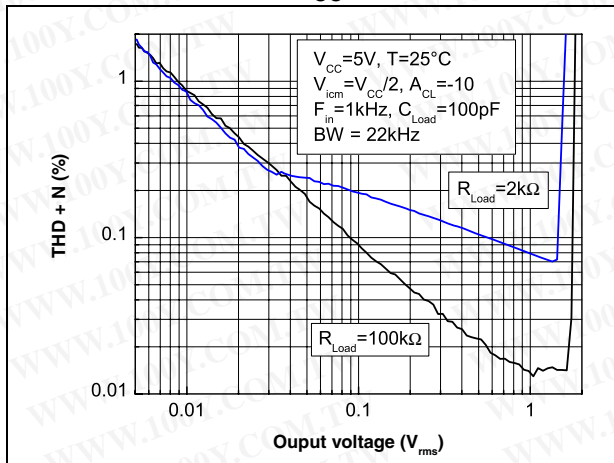

Figure 17. Distortion + noise vs. frequency at $V_{CC} = 5\text{ V}$

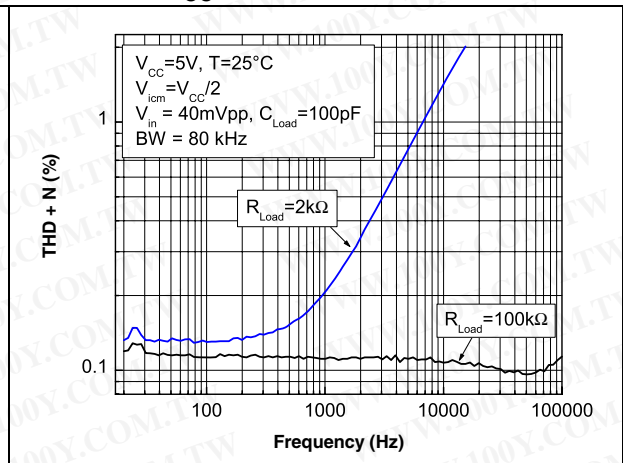
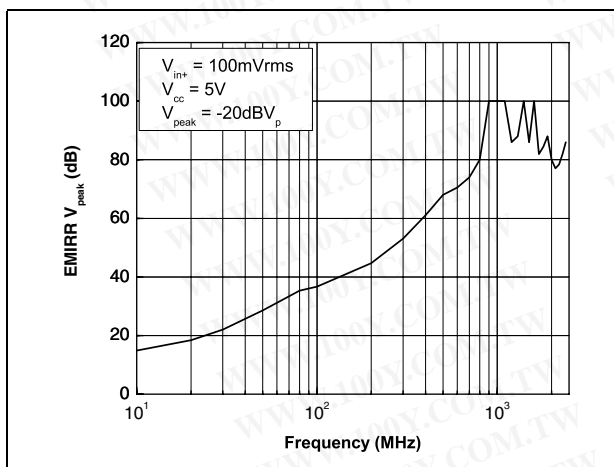

Figure 18. EMIRR vs. frequency at $V_{CC} = 5\text{ V}$, $T = 25^\circ\text{ C}$



4 Application information

4.1 Operating voltages

The TSV639x can operate from 1.5 to 5.5 V. Their parameters are fully specified for 1.8, 3.3 and 5 V power supplies. However, the parameters are very stable in the full V_{CC} range and several characterization curves show the TSV639x characteristics at 1.5 V. Additionally, the main specifications are guaranteed in extended temperature ranges from -40°C to $+125^{\circ}\text{C}$.

4.2 Rail-to-rail input

The TSV639x are built with two complementary PMOS and NMOS input differential pairs. The devices have a rail-to-rail input, and the input common mode range is extended from $V_{CC-} - 0.1\text{ V}$ to $V_{CC+} + 0.1\text{ V}$. The transition between the two pairs appears at $V_{CC+} - 0.7\text{ V}$. In the transition region, the performance of CMR, SVR, V_{i0} (Figure 19 and Figure 20) and THD is slightly degraded.

Figure 19. Input offset voltage vs input common mode at $V_{CC} = 1.5\text{ V}$

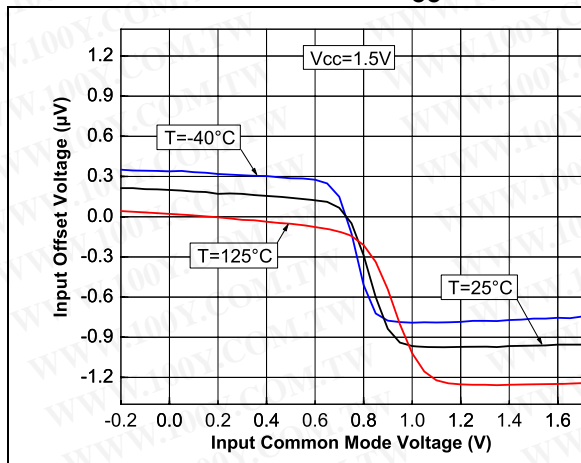
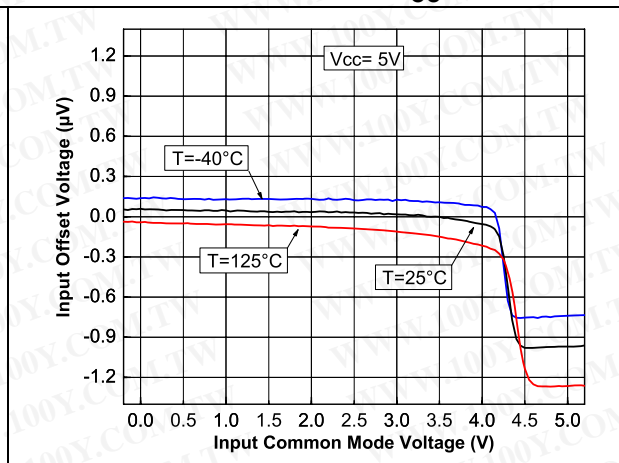

Figure 20. Input offset voltage vs input common mode at $V_{CC} = 5\text{ V}$



The devices are guaranteed without phase reversal.

4.3 Rail-to-rail output

The operational amplifiers' output levels can go close to the rails: 35 mV maximum above and below the rail when connected to a 10 k Ω resistive load to $V_{CC}/2$.

4.4 Shutdown function (TSV6393 - TSV6395)

The operational amplifiers are enabled when the $\overline{\text{SHDN}}$ pin is pulled high. To disable the amplifiers, the $\overline{\text{SHDN}}$ must be pulled down to V_{CC-} . When in shutdown mode, the amplifiers' output is in a high impedance state. The $\overline{\text{SHDN}}$ pin must never be left floating but tied to V_{CC+} or V_{CC-} .

The turn-on and turn-off times are calculated for an output variation of ± 200 mV (Figure 21 and Figure 22 show the test configurations).

Figure 21. Test configuration for turn-on time (Vout pulled down)

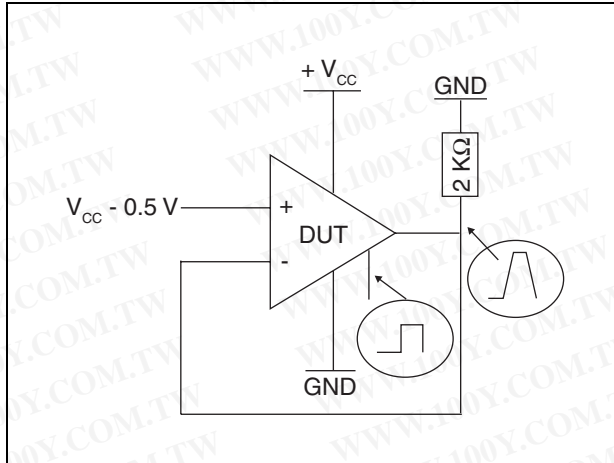

Figure 22. Test configuration for turn-off time (Vout pulled down)

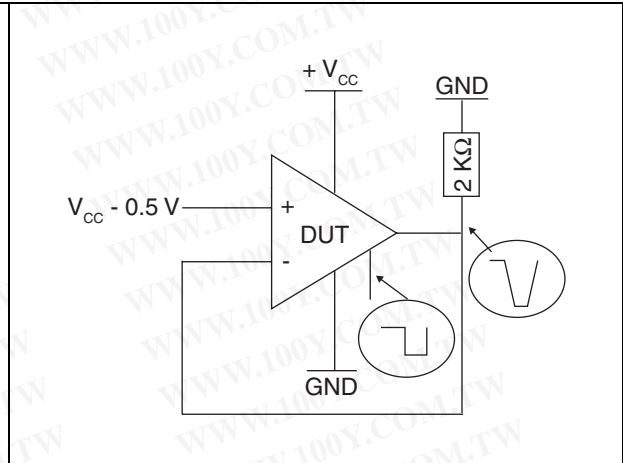

Figure 23. Turn-on time, $V_{CC} = 5$ V, V_{out} pulled down, $T = 25^\circ$ C

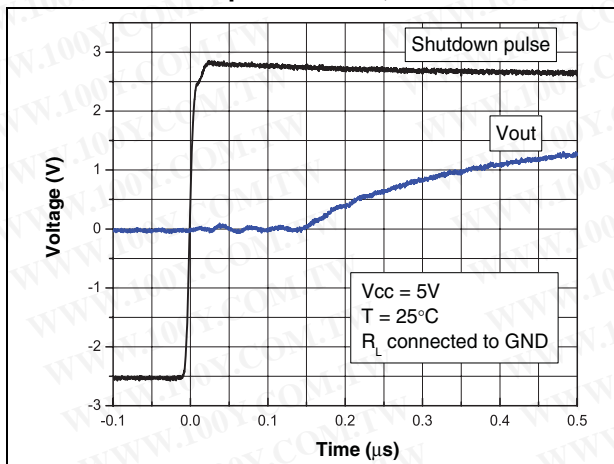
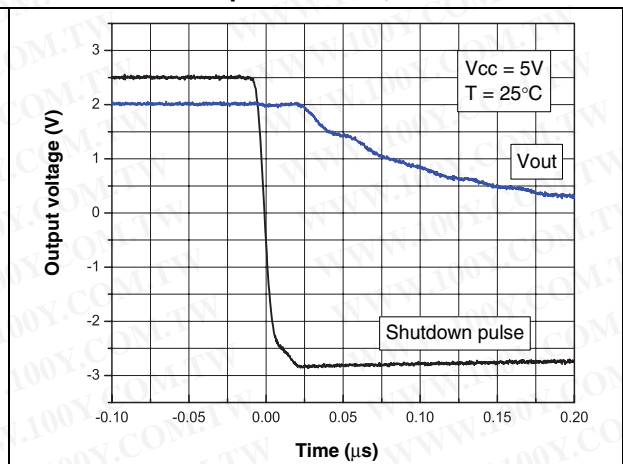

Figure 24. Turn-off time, $V_{CC} = 5$ V, V_{out} pulled down, $T = 25^\circ$ C



4.5 Optimization of DC and AC parameters

These devices use an innovative approach to reduce the spread of the main DC and AC parameters. An internal adjustment achieves a very narrow spread of the current consumption (60 μA typical, min/max at $\pm 17\%$). Parameters linked to the current consumption value, such as GBP, SR and A_{vD} , benefit from this narrow dispersion.

4.6 Driving resistive and capacitive loads

These products are micropower, low-voltage operational amplifiers optimized to drive rather large resistive loads, above 2 k Ω . For lower resistive loads, the THD level may significantly increase.

The amplifiers have a relatively low internal compensation capacitor, making them very fast while consuming very little. They are ideal when used in a non-inverting configuration or in an inverting configuration in the following conditions.

- $|Gain| \geq 3$ in an inverting configuration ($C_L = 20 \text{ pF}$, $R_L = 100 \text{ k}\Omega$) or $|gain| \geq 10$ ($C_L = 100 \text{ pF}$, $R_L = 100 \text{ k}\Omega$)
- $Gain \geq +4$ in a non-inverting configuration ($C_L = 20 \text{ pF}$, $R_L = 100 \text{ k}\Omega$) or $gain \geq +11$ ($C_L = 100 \text{ pF}$, $R_L = 100 \text{ k}\Omega$)

As these operational amplifiers are not unity gain stable, for a low closed-loop gain, it is recommended to use the TSV63x (60 μA , 880 kHz) which is unity gain stable.

Table 9. Related products

Part #	I _{cc} (μA) at 5 V	GBP (MHz)	SR (V/ μs)	Minimum gain for stability ($C_{\text{Load}} = 100 \text{ pF}$)
TSV62-2-3-4-5	29	0.42	0.14	1
TSV629-2-3-4-5	29	1.3	0.5	+11
TSV63-2-3-4-5	60	0.88	0.34	1
TSV639-2-3-4-5	60	2.4	1.1	+11

4.7 PCB layouts

For correct operation, it is advised to add 10 nF decoupling capacitors as close as possible to the power supply pins.

4.8 Macromodel

Two accurate macromodels (with or without shutdown feature) of the TSV639x are available on STMicroelectronics' web site at www.st.com. This model is a trade-off between accuracy and complexity (that is, time simulation) of the TSV639x operational amplifiers. It emulates the nominal performances of a typical device within the specified operating conditions mentioned in the datasheet. It also helps to validate a design approach and to select the right operational amplifier, *but it does not replace on-board measurements*.

5 Package information

In order to meet environmental requirements, ST offers these devices in different grades of ECOPACK® packages, depending on their level of environmental compliance. ECOPACK® specifications, grade definitions and product status are available at: www.st.com. ECOPACK® is an ST trademark.

5.1 SOT23-8 package information

Figure 25. SOT23-8 package mechanical drawing

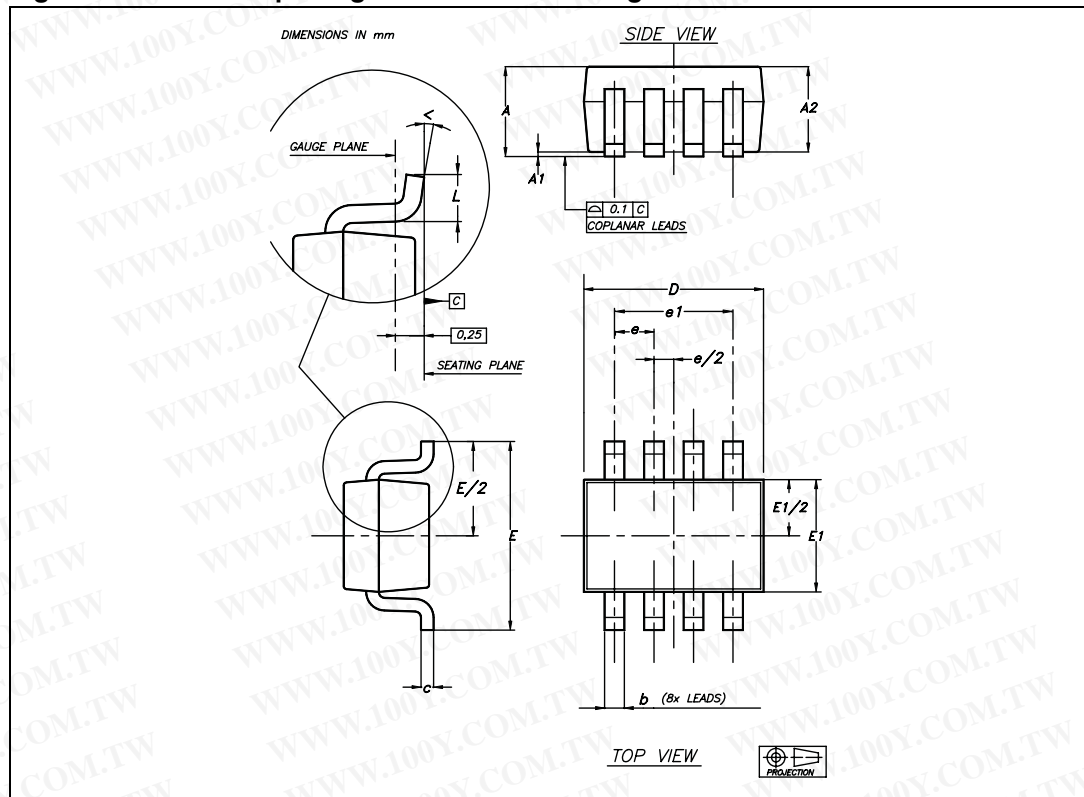

Table 10. SOT23-8 package mechanical data

Ref.	Dimensions					
	Millimeters			Inches		
	Min.	Typ.	Max.	Min.	Typ.	Max.
A			1.45			0.057
A1			0.15			0.006
A2	0.90		1.30	0.035		0.051
b	0.22		0.38	0.009		0.015
c	0.08		0.22	0.003		0.009
D	2.80		3	0.110		0.118
E	2.60		3	0.102		0.118
E1	1.50		1.75	0.059		0.069
e		0.65			0.026	
e1		1.95			0.077	
L	0.30		0.60	0.012		0.024
<	0°		8°			

5.2 SO-8 package information

Figure 26. SO-8 package mechanical drawing

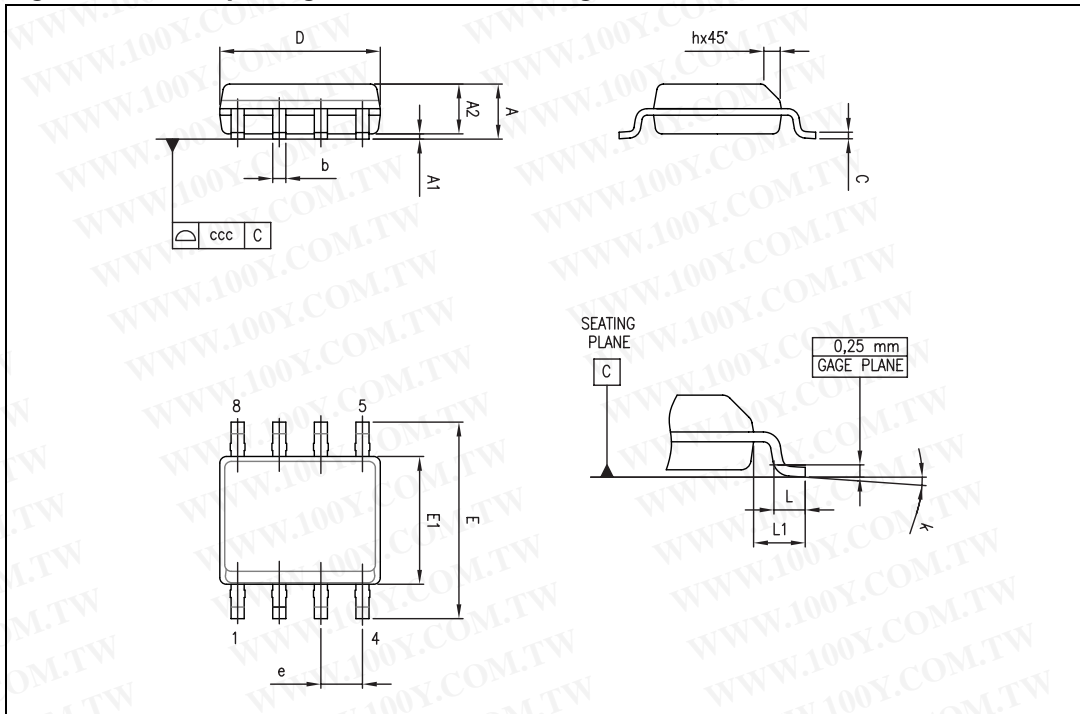

Table 11. SO-8 package mechanical data

Ref.	Dimensions					
	Millimeters			Inches		
	Min.	Typ.	Max.	Min.	Typ.	Max.
A			1.75			0.069
A1	0.10		0.25	0.004		0.010
A2	1.25			0.049		
b	0.28		0.48	0.011		0.019
c	0.17		0.23	0.007		0.010
D	4.80	4.90	5.00	0.189	0.193	0.197
E	5.80	6.00	6.20	0.228	0.236	0.244
E1	3.80	3.90	4.00	0.150	0.154	0.157
e		1.27			0.050	
h	0.25		0.50	0.010		0.020
L	0.40		1.27	0.016		0.050
L1		1.04			0.040	
k	0		8°	1°		8°
ccc			0.10			0.004

5.3 MiniSO-8 package information

Figure 27. MiniSO-8 package mechanical drawing

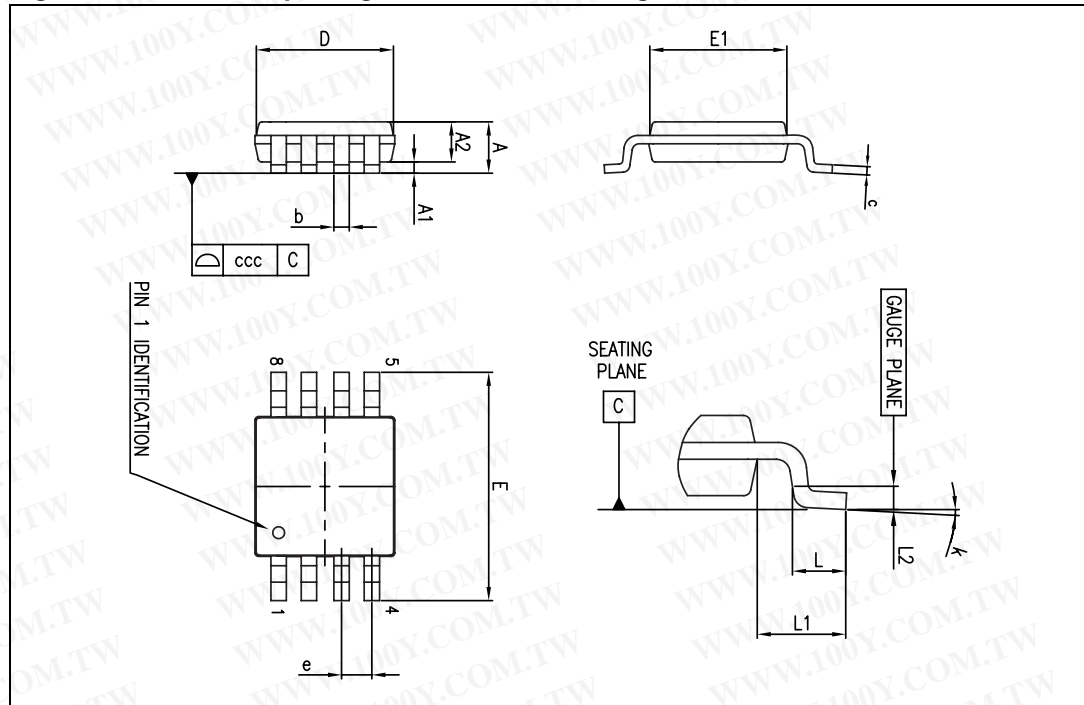

Table 12. MiniSO-8 package mechanical data

Ref.	Dimensions					
	Millimeters			Inches		
	Min.	Typ.	Max.	Min.	Typ.	Max.
A			1.1			0.043
A1	0		0.15	0		0.006
A2	0.75	0.85	0.95	0.030	0.033	0.037
b	0.22		0.40	0.009		0.016
c	0.08		0.23	0.003		0.009
D	2.80	3.00	3.20	0.11	0.118	0.126
E	4.65	4.90	5.15	0.183	0.193	0.203
E1	2.80	3.00	3.10	0.11	0.118	0.122
e		0.65			0.026	
L	0.40	0.60	0.80	0.016	0.024	0.031
L1		0.95			0.037	
L2		0.25			0.010	
k	0°		8°	0°		8°
ccc			0.10			0.004

5.4 MiniSO-10 package information

Figure 28. MiniSO-10 package mechanical drawing

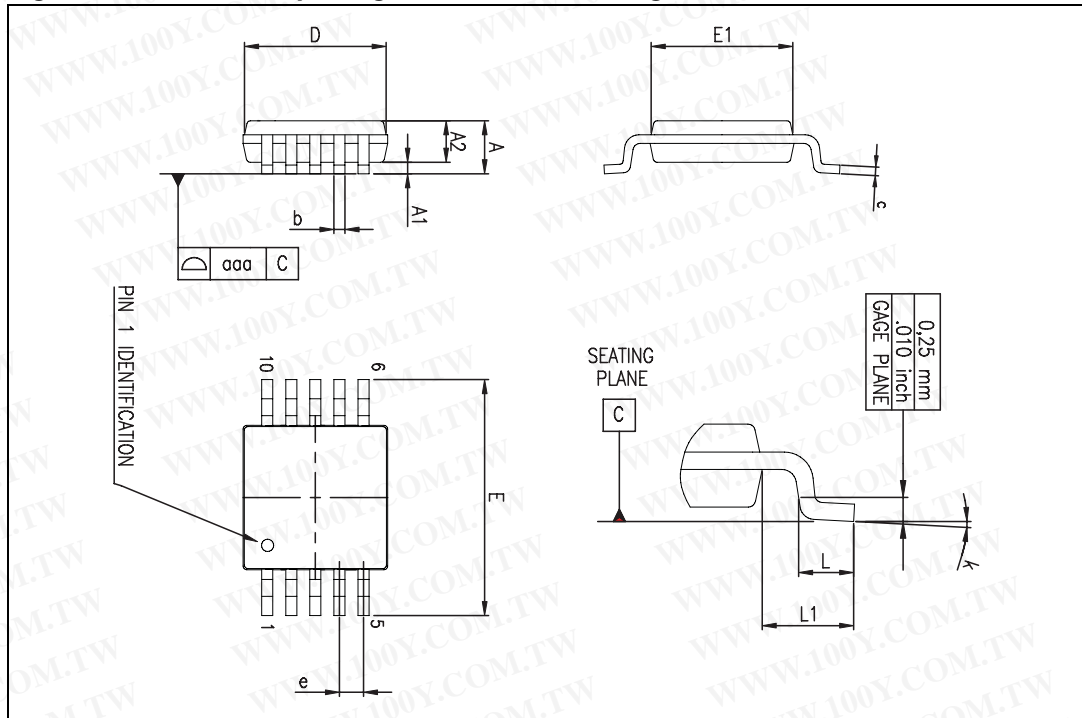

Table 13. MiniSO-10 package mechanical data

Ref.	Dimensions					
	Millimeters			Inches		
	Min.	Typ.	Max.	Min.	Typ.	Max.
A			1.10			0.043
A1	0.05	0.10	0.15	0.002	0.004	0.006
A2	0.78	0.86	0.94	0.031	0.034	0.037
b	0.25	0.33	0.40	0.010	0.013	0.016
c	0.15	0.23	0.30	0.006	0.009	0.012
D	2.90	3.00	3.10	0.114	0.118	0.122
E	4.75	4.90	5.05	0.187	0.193	0.199
E1	2.90	3.00	3.10	0.114	0.118	0.122
e		0.50			0.020	
L	0.40	0.55	0.70	0.016	0.022	0.028
L1		0.95			0.037	
k	0°	3°	6°	0°	3°	6°
aaa			0.10			0.004

5.5 TSSOP14 package information

Figure 29. TSSOP14 package mechanical drawing

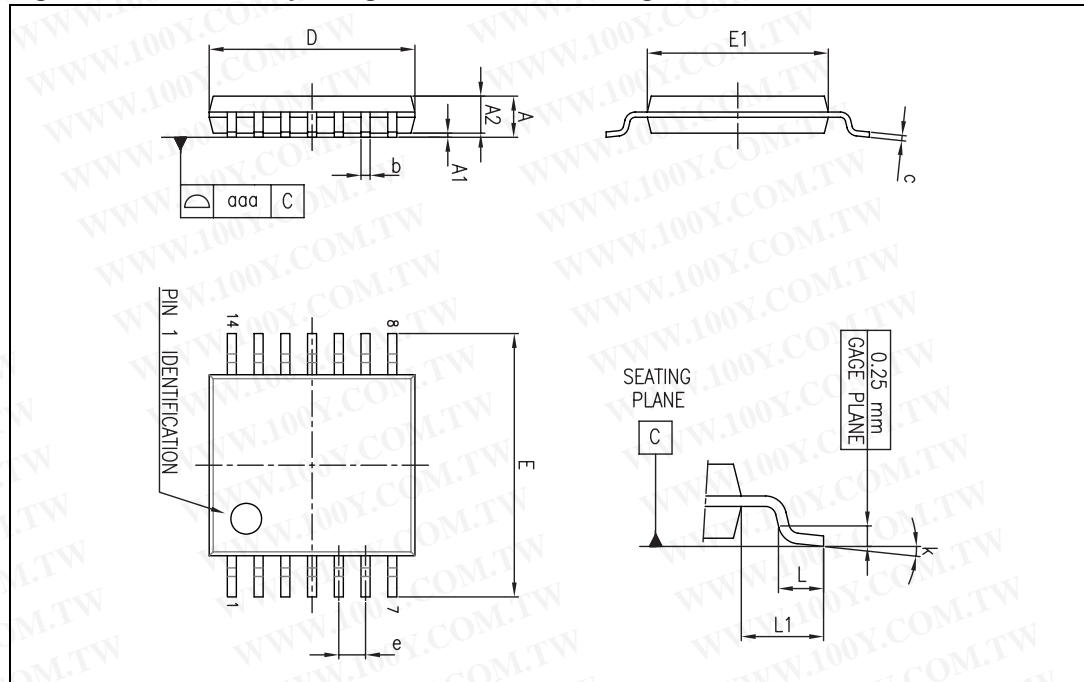

Table 14. TSSOP14 package mechanical data

Ref.	Dimensions					
	Millimeters			Inches		
	Min.	Typ.	Max.	Min.	Typ.	Max.
A			1.20			0.047
A1	0.05		0.15	0.002	0.004	0.006
A2	0.80	1.00	1.05	0.031	0.039	0.041
b	0.19		0.30	0.007		0.012
c	0.09		0.20	0.004		0.0089
D	4.90	5.00	5.10	0.193	0.197	0.201
E	6.20	6.40	6.60	0.244	0.252	0.260
E1	4.30	4.40	4.50	0.169	0.173	0.176
e		0.65			0.0256	
L	0.45	0.60	0.75	0.018	0.024	0.030
L1		1.00			0.039	
k	0°		8°	0°		8°
aaa			0.10			0.004

5.6 TSSOP16 package information

Figure 30. TSSOP16 package mechanical drawing

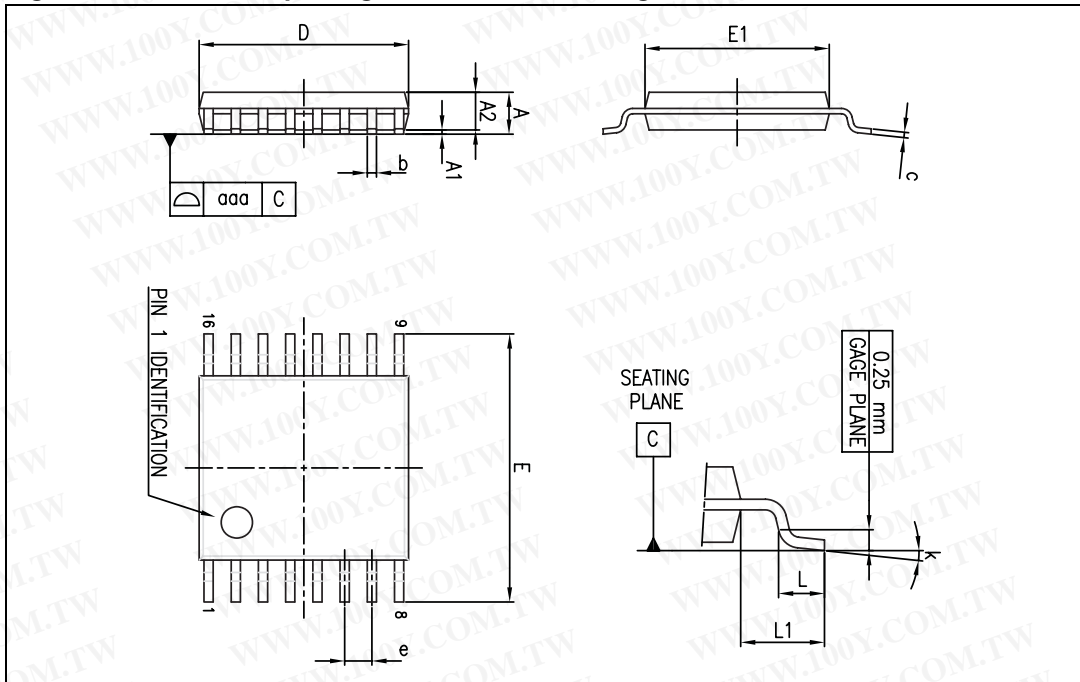

Table 15. TSSOP16 package mechanical data

Ref.	Dimensions					
	Millimeters			Inches		
	Min.	Typ.	Max.	Min.	Typ.	Max.
A			1.20			0.047
A1	0.05		0.15	0.002		0.006
A2	0.80	1.00	1.05	0.031	0.039	0.041
b	0.19		0.30	0.007		0.012
c	0.09		0.20	0.004		0.008
D	4.90	5.00	5.10	0.193	0.197	0.201
E	6.20	6.40	6.60	0.244	0.252	0.260
E1	4.30	4.40	4.50	0.169	0.173	0.177
e		0.65			0.0256	
k	0°		8°	0°		8°
L	0.45	0.60	0.75	0.018	0.024	0.030
L1		1.00			0.039	
aaa			0.10			0.004

6 Ordering information

Table 16. Order codes

Order code	Temperature range	Package	Packing	Marking
TSV6392ID/DT	-40° C to +125° C	SO-8	Tube and tape & reel	V6392I
TSV6392AID/DT				V632AI
TSV6392IST		MiniSO-8	Tape & reel	K111
TSV6392AIST				K146
TSV6392ILT		SOT23-8	Tape & reel	K111
TSV6393IST		MiniSO-10	Tape & reel	K111
TSV6393AIST				K145
TSV6394IPT		TSSOP-14	Tape & reel	V6394I
TSV6394AIPT				V6394AI
TSV6395IPT		TSSOP-16	Tape & reel	V6395I
TSV6395AIPT				V6395AI

7 Revision history

Table 17. Document revision history

Date	Revision	Changes
18-Jan-2010	1	Initial release.

勝特力材料 886-3-5753170
勝特力电子(上海) 86-21-34970699
勝特力电子(深圳) 86-755-83298787
[Http://www.100y.com.tw](http://www.100y.com.tw)

Please Read Carefully:

Information in this document is provided solely in connection with ST products. STMicroelectronics NV and its subsidiaries ("ST") reserve the right to make changes, corrections, modifications or improvements, to this document, and the products and services described herein at any time, without notice.

All ST products are sold pursuant to ST's terms and conditions of sale.

Purchasers are solely responsible for the choice, selection and use of the ST products and services described herein, and ST assumes no liability whatsoever relating to the choice, selection or use of the ST products and services described herein.

No license, express or implied, by estoppel or otherwise, to any intellectual property rights is granted under this document. If any part of this document refers to any third party products or services it shall not be deemed a license grant by ST for the use of such third party products or services, or any intellectual property contained therein or considered as a warranty covering the use in any manner whatsoever of such third party products or services or any intellectual property contained therein.

UNLESS OTHERWISE SET FORTH IN ST'S TERMS AND CONDITIONS OF SALE ST DISCLAIMS ANY EXPRESS OR IMPLIED WARRANTY WITH RESPECT TO THE USE AND/OR SALE OF ST PRODUCTS INCLUDING WITHOUT LIMITATION IMPLIED WARRANTIES OF MERCHANTABILITY, FITNESS FOR A PARTICULAR PURPOSE (AND THEIR EQUIVALENTS UNDER THE LAWS OF ANY JURISDICTION), OR INFRINGEMENT OF ANY PATENT, COPYRIGHT OR OTHER INTELLECTUAL PROPERTY RIGHT.

UNLESS EXPRESSLY APPROVED IN WRITING BY AN AUTHORIZED ST REPRESENTATIVE, ST PRODUCTS ARE NOT RECOMMENDED, AUTHORIZED OR WARRANTED FOR USE IN MILITARY, AIR CRAFT, SPACE, LIFE SAVING, OR LIFE SUSTAINING APPLICATIONS, NOR IN PRODUCTS OR SYSTEMS WHERE FAILURE OR MALFUNCTION MAY RESULT IN PERSONAL INJURY, DEATH, OR SEVERE PROPERTY OR ENVIRONMENTAL DAMAGE. ST PRODUCTS WHICH ARE NOT SPECIFIED AS "AUTOMOTIVE GRADE" MAY ONLY BE USED IN AUTOMOTIVE APPLICATIONS AT USER'S OWN RISK.

Resale of ST products with provisions different from the statements and/or technical features set forth in this document shall immediately void any warranty granted by ST for the ST product or service described herein and shall not create or extend in any manner whatsoever, any liability of ST.

ST and the ST logo are trademarks or registered trademarks of ST in various countries.

Information in this document supersedes and replaces all information previously supplied.

The ST logo is a registered trademark of STMicroelectronics. All other names are the property of their respective owners.

© 2010 STMicroelectronics - All rights reserved

STMicroelectronics group of companies

Australia - Belgium - Brazil - Canada - China - Czech Republic - Finland - France - Germany - Hong Kong - India - Israel - Italy - Japan - Malaysia - Malta - Morocco - Philippines - Singapore - Spain - Sweden - Switzerland - United Kingdom - United States of America

www.st.com

