

**High accuracy (20  $\mu$ V) zero drift micropower 5 V op amp**

Datasheet — production data

**Features**

- Very low offset voltage: 20  $\mu$ V max.
- Ultra low offset voltage drift: 60 nV/°C max.
- Rail-to-rail input and output
- Low supply voltage: 1.8 - 5.5 V
- Low power consumption: 42  $\mu$ A max. at 5 V
- Gain bandwidth product: 400 kHz
- High tolerance to ESD: 4 kV HBM
- Extended temperature range: -40 to +125 °C
- Micro-packages: SC70-5 and SOT23-5

**Applications**

- Battery-powered applications
- Portable devices
- Signal conditioning
- Medical instrumentation

**Description**

The TSZ121 device is the first member of the TSZ12x series of high precision operational amplifiers featuring very low offset voltage with virtually zero drift.

The TSZ12x series offers rail-to-rail input and output, excellent speed/power consumption ratio, and 400 kHz gain bandwidth product, while consuming less than 42  $\mu$ A at 5 V. The devices also feature an ultra-low input bias current.

These features make the TSZ12x family ideal for sensor interfaces, battery-powered applications and portable applications.

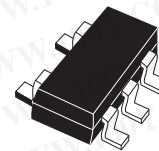
**SC70-5****SOT23-5**

勝特力材料 886-3-5753170  
勝特力电子(上海) 86-21-34970699  
勝特力电子(深圳) 86-755-83298787  
[Http://www.100y.com.tw](http://www.100y.com.tw)

# Contents

<b>1</b>	<b>Package pin connections</b> .....	<b>3</b>
<b>2</b>	<b>Absolute maximum ratings and operating conditions</b> .....	<b>4</b>
<b>3</b>	<b>Electrical characteristics</b> .....	<b>5</b>
<b>4</b>	<b>Application information</b> .....	<b>17</b>
4.1	Theory of operation .....	17
4.1.1	Time domain .....	17
4.1.2	Frequency domain .....	18
4.2	Operating voltages .....	19
4.3	Input pins voltage range .....	19
4.4	Rail-to-rail input .....	19
4.5	Input offset voltage drift over temperature .....	20
4.6	Rail-to-rail output .....	20
4.7	PCB layout recommendations .....	20
	Optimized application recommendation .....	20
4.8	Application examples .....	22
4.8.1	Oxygen sensor .....	22
4.8.2	Precision instrumentation amplifier .....	23
4.8.3	Low-side current sensing .....	24
<b>5</b>	<b>Package information</b> .....	<b>25</b>
<b>6</b>	<b>Ordering information</b> .....	<b>29</b>
<b>7</b>	<b>Revision history</b> .....	<b>29</b>

# 1 Package pin connections

Figure 1. Pin connections for each package (top view)

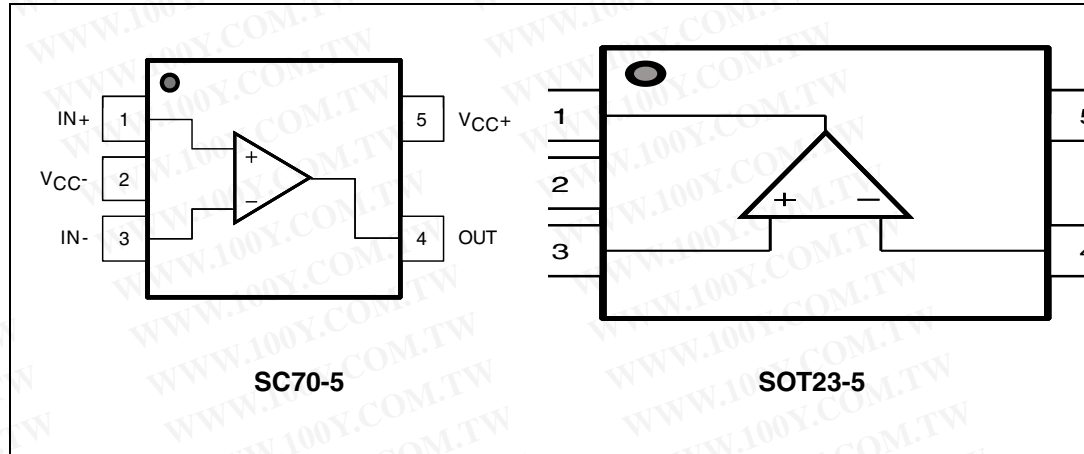

## 2 Absolute maximum ratings and operating conditions

**Table 1. Absolute maximum ratings (AMR)**

Symbol	Parameter	Value	Unit
$V_{CC}$	Supply voltage <sup>(1)</sup>	6	V
$V_{id}$	Differential input voltage <sup>(2)</sup>	$\pm V_{CC}$	V
$V_{in}$	Input voltage <sup>(3)</sup>	$V_{CC-} - 0.2$ to $V_{CC+} + 0.2$	V
$I_{in}$	Input current <sup>(4)</sup>	10	mA
$T_{stg}$	Storage temperature	-65 to +150	°C
$R_{thja}$	Thermal resistance junction-to-ambient <sup>(5), (6)</sup>		°C/W
	SC70-5	205	
	SOT23-5	250	
$T_j$	Maximum junction temperature	150	°C
ESD	HBM: human body model <sup>(7)</sup>	4	kV
	MM: machine model <sup>(8)</sup>	300	V
	CDM: charged device model <sup>(9)</sup>	1.5	kV
	Latch-up immunity	200	mA

- All voltage values, except differential voltage, are with respect to network ground terminal.
- Differential voltages are the non-inverting input terminal with respect to the inverting input terminal.
- $V_{CC-} - V_{in}$  must not exceed 6 V,  $V_{in}$  must not exceed 6 V.
- Input current must be limited by a resistor in series with the inputs.
- Short-circuits can cause excessive heating and destructive dissipation.
- $R_{th}$  are typical values.
- Human body model: 100 pF discharged through a 1.5 kΩ resistor between two pins of the device, done for all couples of pin combinations with other pins floating.
- Machine model: a 200 pF cap is charged to the specified voltage, then discharged directly between two pins of the device with no external series resistor (internal resistor < 5 Ω), done for all couples of pin combinations with other pins floating.
- Charged device model: all pins plus package are charged together to the specified voltage and then discharged directly to ground.

**Table 2. Operating conditions**

Symbol	Parameter	Value	Unit
$V_{CC}$	Supply voltage	1.8 to 5.5	V
$V_{icm}$	Common mode input voltage range	$V_{CC-} - 0.1$ to $V_{CC+} + 0.1$	V
$T_{oper}$	Operating free air temperature range	-40 to +125	°C

### 3 Electrical characteristics

**Table 3. Electrical characteristics at  $V_{CC+} = 1.8\text{ V}$  with  $V_{CC-} = 0\text{ V}$ ,  $V_{icm} = V_{CC}/2$ ,  $T = 25\text{ }^\circ\text{C}$ , and  $R_L = 10\text{ k}\Omega$  connected to  $V_{CC}/2$  (unless otherwise specified)**

Symbol	Parameter	Conditions	Min.	Typ.	Max.	Unit
<b>DC performance</b>						
$V_{io}$	Input offset voltage	$T = 25\text{ }^\circ\text{C}$		1	20	$\mu\text{V}$
		$-40\text{ }^\circ\text{C} < T < 125\text{ }^\circ\text{C}$			28	
$\Delta V_{io}/\Delta T$	Input offset voltage drift <sup>(1)</sup>	$-40\text{ }^\circ\text{C} < T < 125\text{ }^\circ\text{C}$		0.01	0.08	$\mu\text{V}/^\circ\text{C}$
$I_{io}$	Input offset current ( $V_{out} = V_{CC}/2$ )	$T = 25\text{ }^\circ\text{C}$		100	400 <sup>(2)</sup>	$\text{pA}$
		$-40\text{ }^\circ\text{C} < T < 125\text{ }^\circ\text{C}$			600 <sup>(2)</sup>	
$I_{ib}$	Input bias current ( $V_{out} = V_{CC}/2$ )	$T = 25\text{ }^\circ\text{C}$		50	200 <sup>(2)</sup>	$\text{pA}$
		$-40\text{ }^\circ\text{C} < T < 125\text{ }^\circ\text{C}$			300 <sup>(2)</sup>	
CMR	Common mode rejection ratio $20\text{ log } (\Delta V_{icm}/\Delta V_{io})$ $V_{ic} = 0\text{ V to } V_{CC}$ , $V_{out} = V_{CC}/2$ , $R_L > 1\text{ M}\Omega$	$T = 25\text{ }^\circ\text{C}$	100	112		$\text{dB}$
		$-40\text{ }^\circ\text{C} < T < 125\text{ }^\circ\text{C}$	100			
$A_{vd}$	Large signal voltage gain $V_{out} = 0.5\text{ V to } (V_{CC} - 0.5\text{ V})$	$T = 25\text{ }^\circ\text{C}$		135		$\text{dB}$
		$-40\text{ }^\circ\text{C} < T < 125\text{ }^\circ\text{C}$	110			
$V_{OH}$	High level output voltage	$T = 25\text{ }^\circ\text{C}$			30	$\text{mV}$
		$-40\text{ }^\circ\text{C} < T < 125\text{ }^\circ\text{C}$			70	
$V_{OL}$	Low level output voltage	$T = 25\text{ }^\circ\text{C}$			30	$\text{mV}$
		$-40\text{ }^\circ\text{C} < T < 125\text{ }^\circ\text{C}$			70	
$I_{out}$	$I_{sink} (V_{out} = V_{CC})$	$T = 25\text{ }^\circ\text{C}$	7	8		$\text{mA}$
		$-40\text{ }^\circ\text{C} < T < 125\text{ }^\circ\text{C}$	6			
	$I_{source} (V_{out} = 0\text{ V})$	$T = 25\text{ }^\circ\text{C}$	5	7		$\text{mA}$
		$-40\text{ }^\circ\text{C} < T < 125\text{ }^\circ\text{C}$	4			
$I_{CC}$	Supply current (per operator, $V_{out} = V_{CC}/2$ , $R_L > 1\text{ M}\Omega$ )	$T = 25\text{ }^\circ\text{C}$		28	42	$\mu\text{A}$
		$-40\text{ }^\circ\text{C} < T < 125\text{ }^\circ\text{C}$			45	



**Table 3. Electrical characteristics at  $V_{CC+} = 1.8\text{ V}$  with  $V_{CC-} = 0\text{ V}$ ,  $V_{icm} = V_{CC}/2$ ,  $T = 25\text{ }^{\circ}\text{C}$ , and  $R_L = 10\text{ k}\Omega$  connected to  $V_{CC}/2$  (unless otherwise specified) (continued)**

Symbol	Parameter	Conditions	Min.	Typ.	Max.	Unit
<b>AC performance</b>						
GBP	Gain bandwidth product	$R_L = 10\text{ k}\Omega$ $C_L = 100\text{ pF}$		400		kHz
$F_u$	Unity gain frequency	$R_L = 10\text{ k}\Omega$ $C_L = 100\text{ pF}$		300		kHz
$\Phi_m$	Phase margin	$R_L = 10\text{ k}\Omega$ $C_L = 100\text{ pF}$		55		degrees
$G_m$	Gain margin	$R_L = 10\text{ k}\Omega$ $C_L = 100\text{ pF}$		17		dB
$t_s$	Settling time	To 0.1%, $V_{in} = 1\text{ Vp-p}$ , $R_L = 10\text{ k}\Omega$ $C_L = 100\text{ pF}$		50		$\mu\text{s}$
SR	Slew rate <sup>(3)</sup>	$R_L = 10\text{ k}\Omega$ $C_L = 100\text{ pF}$		0.17		$\text{V}/\mu\text{s}$
$e_n$	Equivalent input noise voltage	$f = 1\text{ kHz}$ $f = 10\text{ kHz}$		50 50		$\frac{\text{nV}}{\sqrt{\text{Hz}}}$
$t_{init}$	Initialization time	$T = 25\text{ }^{\circ}\text{C}$ $-40\text{ }^{\circ}\text{C} < T < 125\text{ }^{\circ}\text{C}$		50 100		$\mu\text{s}$

1. See [Section 4.5: Input offset voltage drift over temperature on page 20](#). Input offset voltage performance is enhanced by appropriate supply voltage decoupling, see [Section 4.7: PCB layout recommendations on page 20](#).
2. Guaranteed by design.
3. Slew rate value is calculated as the average between positive and negative slew rates.

**Table 4. Electrical characteristics at  $V_{CC+} = 3.3\text{ V}$  with  $V_{CC-} = 0\text{ V}$ ,  $V_{icm} = V_{CC}/2$ ,  $T = 25\text{ }^{\circ}\text{C}$ , and  $R_L = 10\text{ k}\Omega$  connected to  $V_{CC}/2$  (unless otherwise specified)**

Symbol	Parameter	Conditions	Min.	Typ.	Max.	Unit
<b>DC performance</b>						
$V_{io}$	Input offset voltage	$T = 25\text{ }^{\circ}\text{C}$		1	20	$\mu\text{V}$
		$-40\text{ }^{\circ}\text{C} < T < 125\text{ }^{\circ}\text{C}$			26	
$\Delta V_{io}/\Delta T$	Input offset voltage drift <sup>(1)</sup>	$-40\text{ }^{\circ}\text{C} < T < 125\text{ }^{\circ}\text{C}$		0.01	0.06	$\mu\text{V}/^{\circ}\text{C}$
$I_{io}$	Input offset current ( $V_{out} = V_{CC}/2$ )	$T = 25\text{ }^{\circ}\text{C}$		120	400 <sup>(2)</sup>	$\mu\text{A}$
		$-40\text{ }^{\circ}\text{C} < T < 125\text{ }^{\circ}\text{C}$			600 <sup>(2)</sup>	
$I_{ib}$	Input bias current ( $V_{out} = V_{CC}/2$ )	$T = 25\text{ }^{\circ}\text{C}$		60	200 <sup>(2)</sup>	$\mu\text{A}$
		$-40\text{ }^{\circ}\text{C} < T < 125\text{ }^{\circ}\text{C}$			300 <sup>(2)</sup>	
CMR	Common mode rejection ratio $20 \log (\Delta V_{icm}/\Delta V_{io})$ $V_{ic} = 0\text{ V to } V_{CC}$ , $V_{out} = V_{CC}/2$ $R_L > 1\text{ M}\Omega$	$T = 25\text{ }^{\circ}\text{C}$	106	118		dB
		$-40\text{ }^{\circ}\text{C} < T < 125\text{ }^{\circ}\text{C}$	106			
$A_{vd}$	Large signal voltage gain $V_{out} = 0.5\text{ V to } (V_{CC} - 0.5\text{ V})$	$T = 25\text{ }^{\circ}\text{C}$	118	135		dB
		$-40\text{ }^{\circ}\text{C} < T < 125\text{ }^{\circ}\text{C}$	110			
$V_{OH}$	High level output voltage	$T = 25\text{ }^{\circ}\text{C}$			30	mV
		$-40\text{ }^{\circ}\text{C} < T < 125\text{ }^{\circ}\text{C}$			70	
$V_{OL}$	Low level output voltage	$T = 25\text{ }^{\circ}\text{C}$			30	mV
		$-40\text{ }^{\circ}\text{C} < T < 125\text{ }^{\circ}\text{C}$			70	
$I_{out}$	$I_{sink} (V_{out} = V_{CC})$	$T = 25\text{ }^{\circ}\text{C}$	15	18		mA
		$-40\text{ }^{\circ}\text{C} < T < 125\text{ }^{\circ}\text{C}$	12			
	$I_{source} (V_{out} = 0\text{ V})$	$T = 25\text{ }^{\circ}\text{C}$	14	16		mA
		$-40\text{ }^{\circ}\text{C} < T < 125\text{ }^{\circ}\text{C}$	10			
$I_{CC}$	Supply current (per operator, $V_{out} = V_{CC}/2$ , $R_L > 1\text{ M}\Omega$ )	$T = 25\text{ }^{\circ}\text{C}$		29	42	$\mu\text{A}$
		$-40\text{ }^{\circ}\text{C} < T < 125\text{ }^{\circ}\text{C}$			45	

**Table 4. Electrical characteristics at  $V_{CC+} = 3.3\text{ V}$  with  $V_{CC-} = 0\text{ V}$ ,  $V_{icm} = V_{CC}/2$ ,  $T = 25\text{ }^{\circ}\text{C}$ , and  $R_L = 10\text{ k}\Omega$  connected to  $V_{CC}/2$  (unless otherwise specified) (continued)**

Symbol	Parameter	Conditions	Min.	Typ.	Max.	Unit
<b>AC performance</b>						
GBP	Gain bandwidth product	$R_L = 10\text{ k}\Omega$ $C_L = 100\text{ pF}$		400		kHz
$F_u$	Unity gain frequency	$R_L = 10\text{ k}\Omega$ $C_L = 100\text{ pF}$		300		kHz
$\Phi_m$	Phase margin	$R_L = 10\text{ k}\Omega$ $C_L = 100\text{ pF}$		56		degrees
$G_m$	Gain margin	$R_L = 10\text{ k}\Omega$ $C_L = 100\text{ pF}$		19		dB
$t_s$	Settling time	To 0.1%, $V_{in} = 1\text{ V}_{p-p}$ , $R_L = 10\text{ k}\Omega$ $C_L = 100\text{ pF}$		50		$\mu\text{s}$
SR	Slew rate <sup>(3)</sup>	$R_L = 10\text{ k}\Omega$ $C_L = 100\text{ pF}$		0.19		$\text{V}/\mu\text{s}$
$e_n$	Equivalent input noise voltage	$f = 1\text{ kHz}$ $f = 10\text{ kHz}$		50 50		$\frac{\text{nV}}{\sqrt{\text{Hz}}}$
$t_{init}$	Initialization time	$T = 25\text{ }^{\circ}\text{C}$		50		$\mu\text{s}$
		$-40\text{ }^{\circ}\text{C} < T < 125\text{ }^{\circ}\text{C}$		100		

1. See [Section 4.5: Input offset voltage drift over temperature on page 20](#). Input offset voltage performance is enhanced by appropriate supply voltage decoupling, see [Section 4.7: PCB layout recommendations on page 20](#).
2. Guaranteed by design.
3. Slew rate value is calculated as the average between positive and negative slew rates.



**Table 5. Electrical characteristics at  $V_{CC+} = 5\text{ V}$  with  $V_{CC-} = 0\text{ V}$ ,  $V_{icm} = V_{CC}/2$ ,  $T = 25\text{ }^\circ\text{C}$ , and  $R_L = 10\text{ k}\Omega$  connected to  $V_{CC}/2$  (unless otherwise specified)**

Symbol	Parameter	Conditions	Min.	Typ.	Max.	Unit
<b>DC performance</b>						
$V_{io}$	Input offset voltage	$T = 25\text{ }^\circ\text{C}$		1	20	$\mu\text{V}$
		$-40\text{ }^\circ\text{C} < T < 125\text{ }^\circ\text{C}$			26	
$\Delta V_{io}/\Delta T$	Input offset voltage drift <sup>(1)</sup>	$-40\text{ }^\circ\text{C} < T < 125\text{ }^\circ\text{C}$		0.01	0.06	$\mu\text{V}/^\circ\text{C}$
$I_{io}$	Input offset current ( $V_{out} = V_{CC}/2$ )	$T = 25\text{ }^\circ\text{C}$		140	400 <sup>(2)</sup>	$\text{pA}$
		$-40\text{ }^\circ\text{C} < T < 125\text{ }^\circ\text{C}$			600 <sup>(2)</sup>	
$I_{ib}$	Input bias current ( $V_{out} = V_{CC}/2$ )	$T = 25\text{ }^\circ\text{C}$		70	200 <sup>(2)</sup>	$\text{pA}$
		$-40\text{ }^\circ\text{C} < T < 125\text{ }^\circ\text{C}$			300 <sup>(2)</sup>	
CMR	Common mode rejection ratio $20 \log (\Delta V_{icm}/\Delta V_{io})$ $V_{ic} = 0\text{ V}$ to $V_{CC}/2$ , $V_{out} = V_{CC}/2$ $R_L > 1\text{ M}\Omega$	$T = 25\text{ }^\circ\text{C}$	110	126		dB
		$-40\text{ }^\circ\text{C} < T < 125\text{ }^\circ\text{C}$	110			
SVR	Supply voltage rejection ratio $20 \log (\Delta V_{CC}/\Delta V_{io})$ $V_{CC} = 1.8$ to $5.5\text{ V}$ , $V_{out} = V_{CC}/2$ , $R_L > 1\text{ M}\Omega$	$T = 25\text{ }^\circ\text{C}$	106	115		dB
		$-40\text{ }^\circ\text{C} < T < 125\text{ }^\circ\text{C}$	106			
$A_{vd}$	Large signal voltage gain $V_{out} = 0.5\text{ V}$ to $(V_{CC} - 0.5\text{ V})$	$T = 25\text{ }^\circ\text{C}$	120	135		dB
		$-40\text{ }^\circ\text{C} < T < 125\text{ }^\circ\text{C}$	110			
$V_{OH}$	High level output voltage	$T = 25\text{ }^\circ\text{C}$			30	mV
		$-40\text{ }^\circ\text{C} < T < 125\text{ }^\circ\text{C}$			70	
$V_{OL}$	Low level output voltage	$T = 25\text{ }^\circ\text{C}$			30	mV
		$-40\text{ }^\circ\text{C} < T < 125\text{ }^\circ\text{C}$			70	
$I_{out}$	$I_{sink} (V_{out} = V_{CC}/2)$	$T = 25\text{ }^\circ\text{C}$	15	18		mA
		$-40\text{ }^\circ\text{C} < T < 125\text{ }^\circ\text{C}$	14			
	$I_{source} (V_{out} = 0\text{ V})$	$T = 25\text{ }^\circ\text{C}$	14	17		mA
		$-40\text{ }^\circ\text{C} < T < 125\text{ }^\circ\text{C}$	12			
$I_{CC}$	Supply current (per operator, $V_{out} = V_{CC}/2$ , $R_L > 1\text{ M}\Omega$ )	$T = 25\text{ }^\circ\text{C}$		31	42	$\mu\text{A}$
		$-40\text{ }^\circ\text{C} < T < 125\text{ }^\circ\text{C}$			45	

**Table 5. Electrical characteristics at  $V_{CC+} = 5\text{ V}$  with  $V_{CC-} = 0\text{ V}$ ,  $V_{icm} = V_{CC}/2$ ,  $T = 25\text{ }^{\circ}\text{C}$ , and  $R_L = 10\text{ k}\Omega$  connected to  $V_{CC}/2$  (unless otherwise specified) (continued)**

Symbol	Parameter	Conditions	Min.	Typ.	Max.	Unit
<b>AC performance</b>						
GBP	Gain bandwidth product	$R_L = 10\text{ k}\Omega$ , $C_L = 100\text{ pF}$		400		kHz
$F_u$	Unity gain frequency	$R_L = 10\text{ k}\Omega$ , $C_L = 100\text{ pF}$		300		kHz
$\Phi_m$	Phase margin	$R_L = 10\text{ k}\Omega$ , $C_L = 100\text{ pF}$		53		degrees
$G_m$	Gain margin	$R_L = 10\text{ k}\Omega$ , $C_L = 100\text{ pF}$		19		dB
$t_s$	Settling time	To 0.1%, $V_{in} = 1\text{ V}_{p-p}$ , $R_L = 10\text{ k}\Omega$ , $C_L = 100\text{ pF}$		50		$\mu\text{s}$
SR	Slew rate <sup>(3)</sup>	$R_L = 10\text{ k}\Omega$ , $C_L = 100\text{ pF}$		0.19		$\text{V}/\mu\text{s}$
$e_n$	Equivalent input noise voltage	$f = 1\text{ kHz}$ $f = 10\text{ kHz}$		50 50		$\frac{\text{nV}}{\sqrt{\text{Hz}}}$
$t_{init}$	Initialization time	$T = 25\text{ }^{\circ}\text{C}$ $-40\text{ }^{\circ}\text{C} < T < 125\text{ }^{\circ}\text{C}$		50 100		$\mu\text{s}$

1. See [Section 4.5: Input offset voltage drift over temperature on page 20](#). Input offset voltage performance is enhanced by appropriate supply voltage decoupling, see [Section 4.7: PCB layout recommendations on page 20](#).
2. Guaranteed by design.
3. Slew rate value is calculated as the average between positive and negative slew rates.

**Figure 2. Supply current vs. supply voltage at  $V_{icm} = V_{cc}/2$**

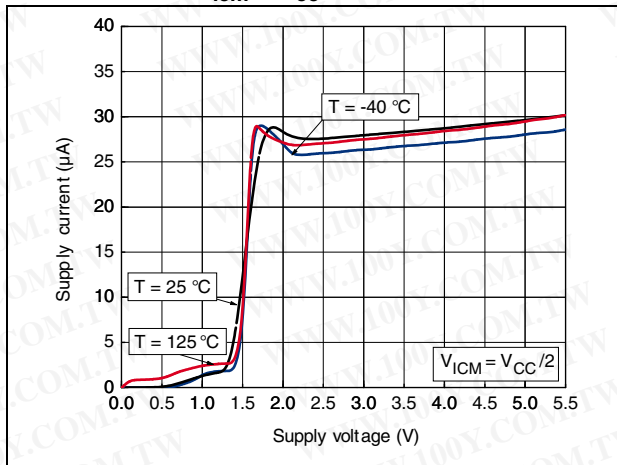

**Figure 3. Input offset voltage distribution at  $V_{CC} = 5\text{ V}$ ,  $V_{icm} = V_{cc}/2$**

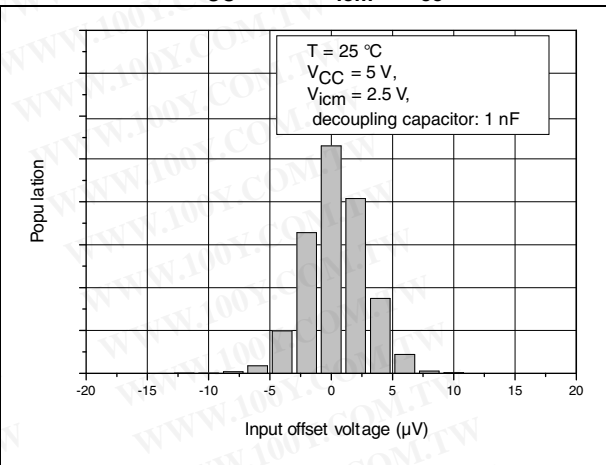

**Figure 4.  $V_{io}$  temperature coefficient distribution (absolute value)**

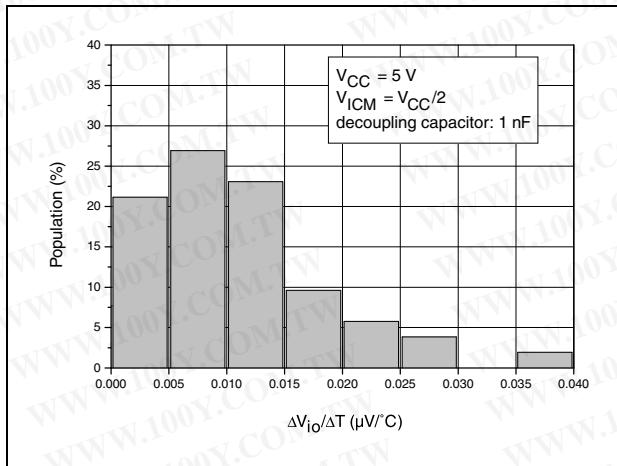

**Figure 5. Input offset voltage vs. supply voltage at  $V_{icm} = V_{CC}/2$**

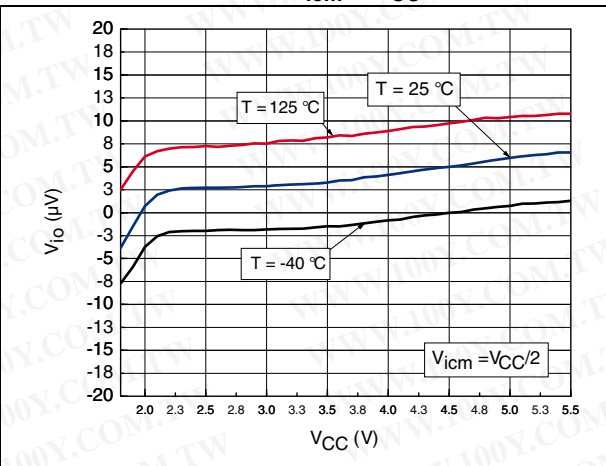

**Figure 6. Input offset voltage vs. input common-mode at  $V_{CC} = 1.8\text{ V}$**

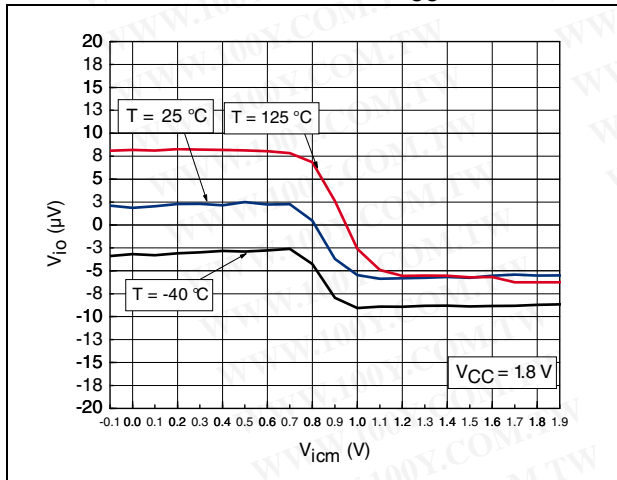

**Figure 7. Input offset voltage vs. input common-mode at  $V_{CC} = 2.7\text{ V}$**

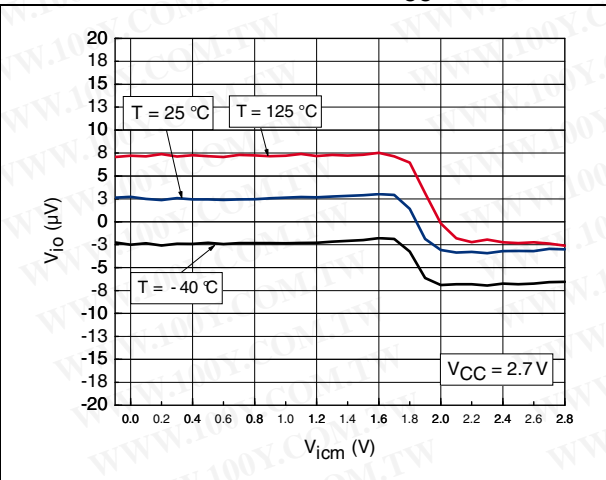

Figure 8. Input offset voltage vs. input common-mode at  $V_{CC} = 5.5\text{ V}$

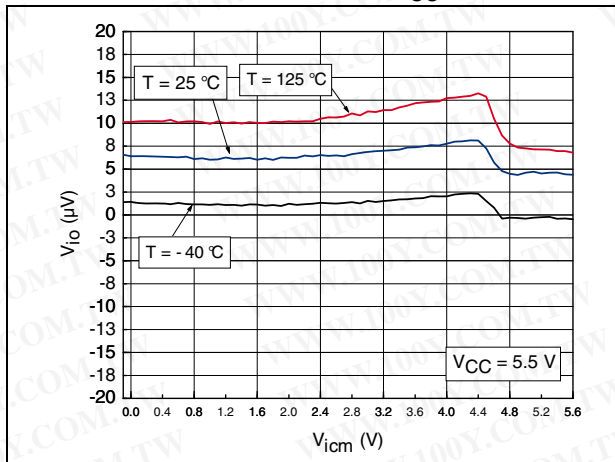

Figure 9. Input offset voltage vs. temperature

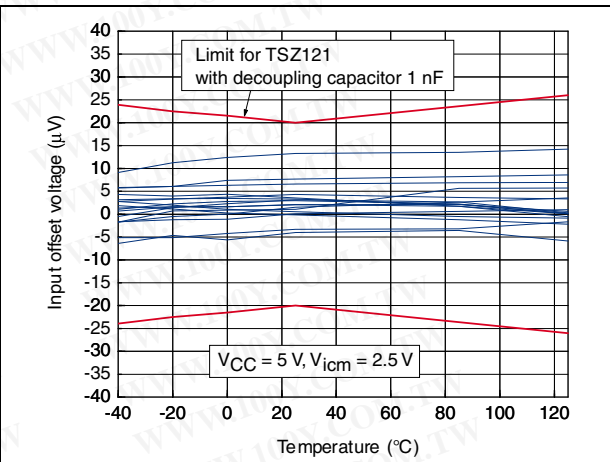

Figure 10. Output current vs. output voltage at  $V_{CC} = 1.8\text{ V}$

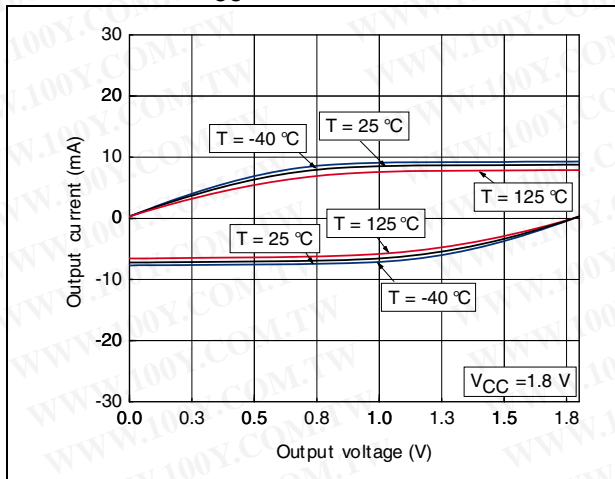

Figure 11. Output current vs. output voltage at  $V_{CC} = 5\text{ V}$

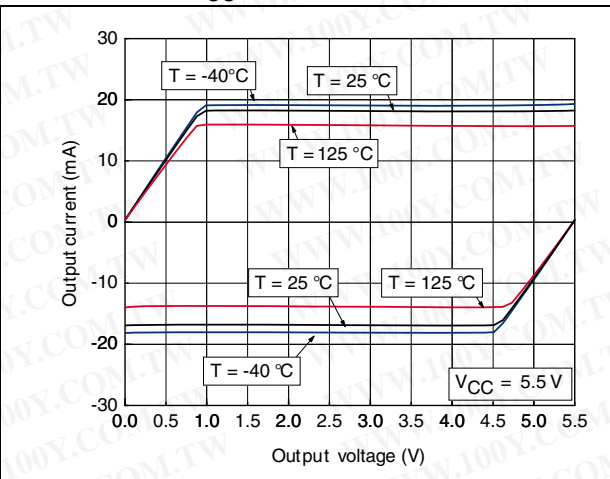

Figure 12. Input bias current vs. common mode at  $V_{CC} = 1.8\text{ V}$

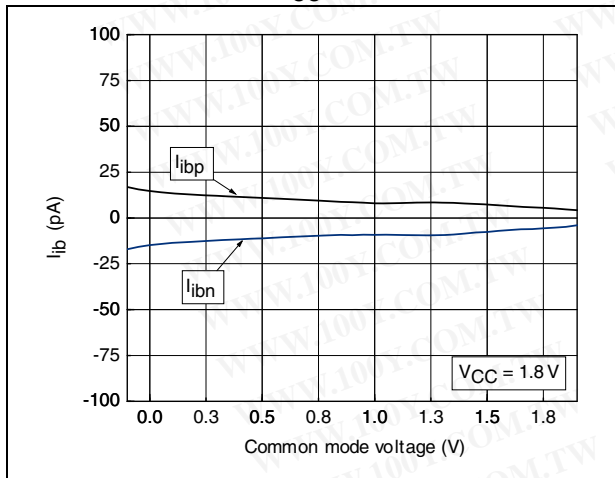

Figure 13. Input bias current vs. common mode at  $V_{CC} = 5\text{ V}$

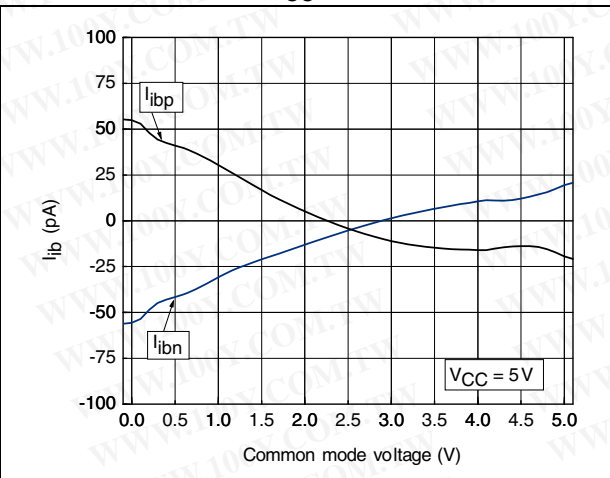



Figure 14. Output current vs. output voltage at  $V_{CC} = 1.8\text{ V}$

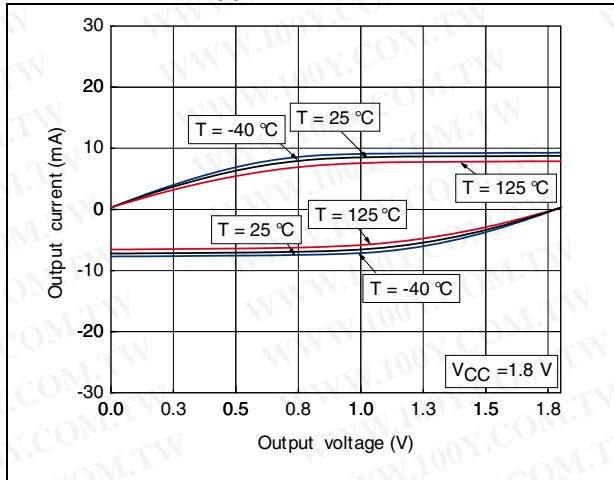

Figure 15. Output current vs. output voltage at  $V_{CC} = 5\text{ V}$

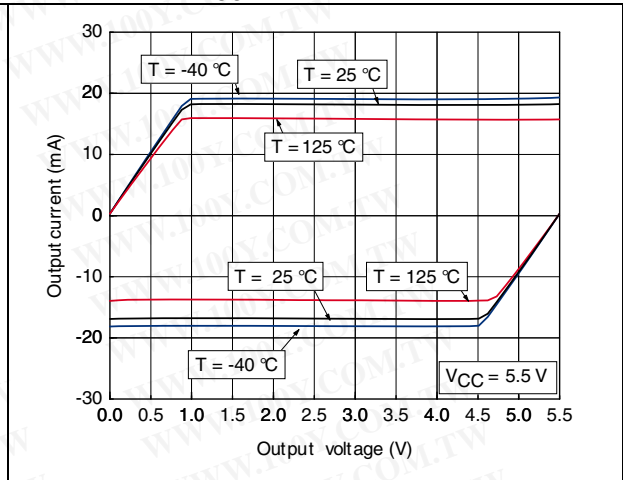

Figure 16. Bode diagram at  $V_{CC} = 1.8\text{ V}$ ,  $R_L = 10\text{ k}\Omega$

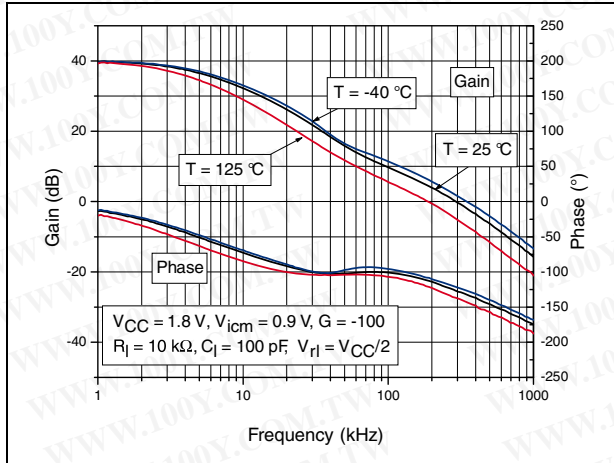

Figure 17. Bode diagram at  $V_{CC} = 2.7\text{ V}$ ,  $R_L = 10\text{ k}\Omega$

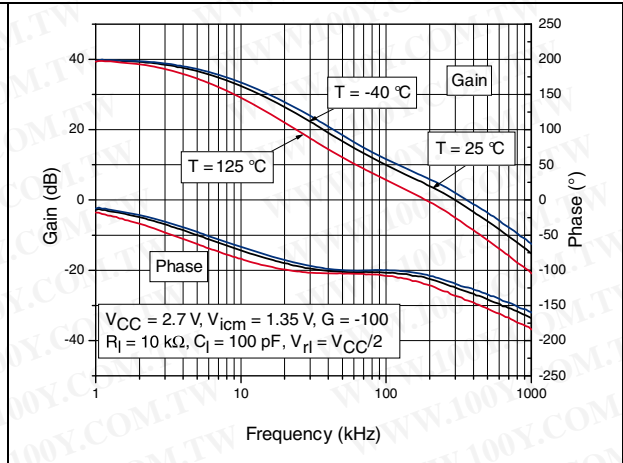

Figure 18. Bode diagram at  $V_{CC} = 5.5\text{ V}$ ,  $R_L = 10\text{ k}\Omega$

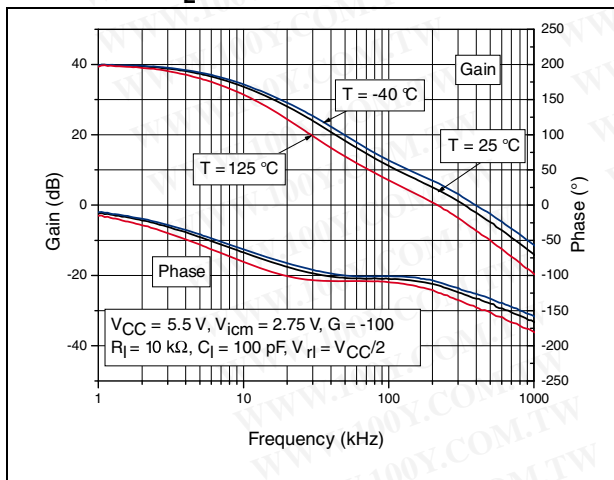

Figure 19. Open loop gain vs. frequency

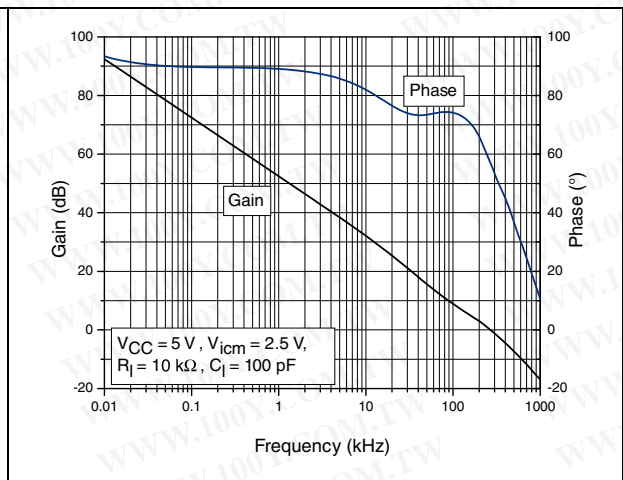



Figure 20. Output overshoot vs. load capacitance

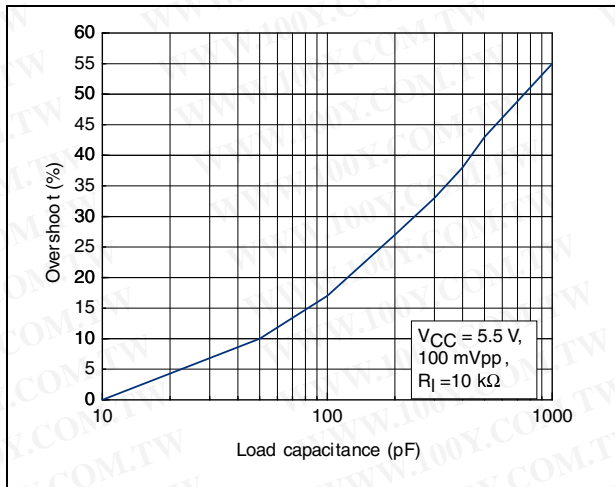

Figure 21. Output impedance vs. frequency

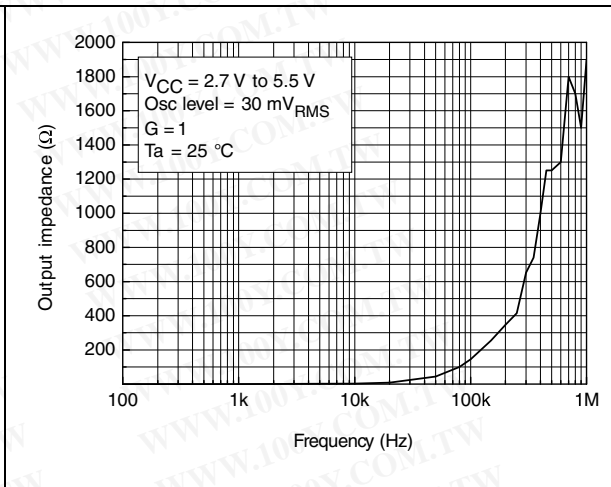

Figure 22. 0.1 Hz to 10 Hz noise

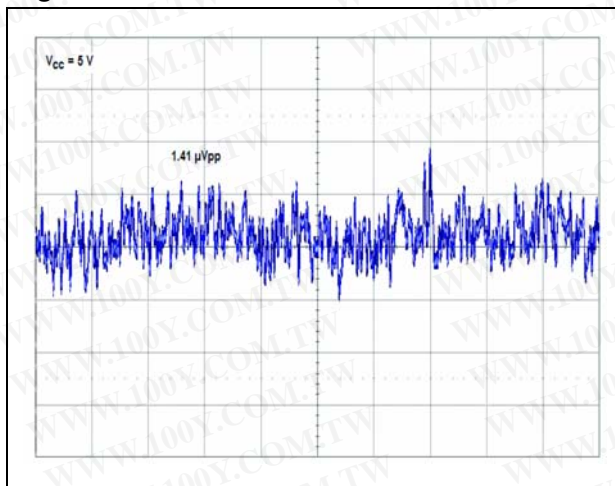

Figure 23. Noise vs. frequency

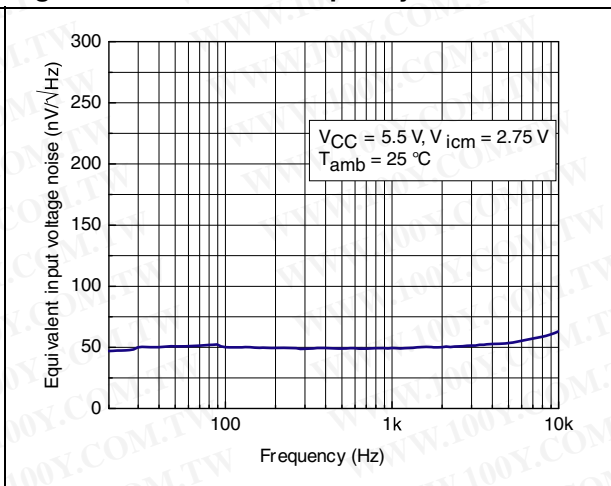

Figure 24. Small signal

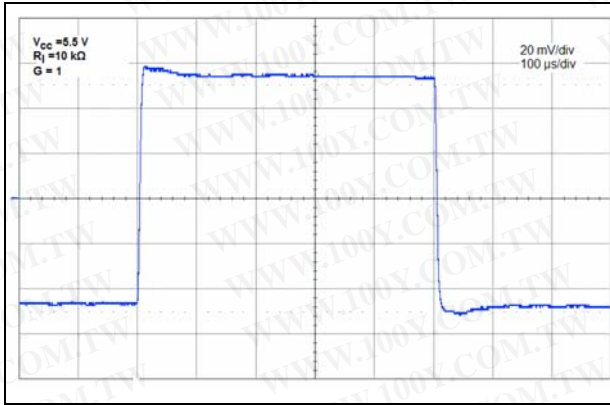

Figure 25. Large signal

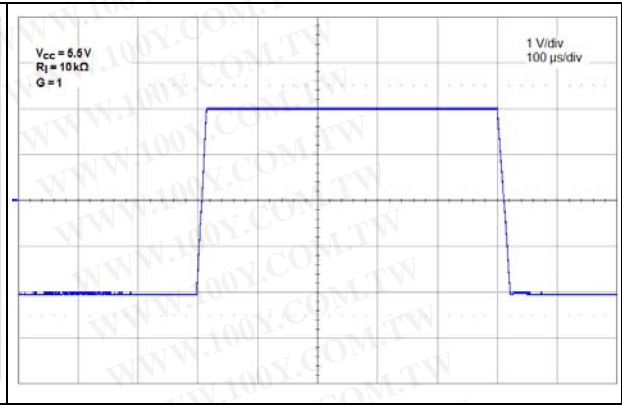

Figure 26. Positive overvoltage recovery at  $V_{CC} = 1.8\text{ V}$

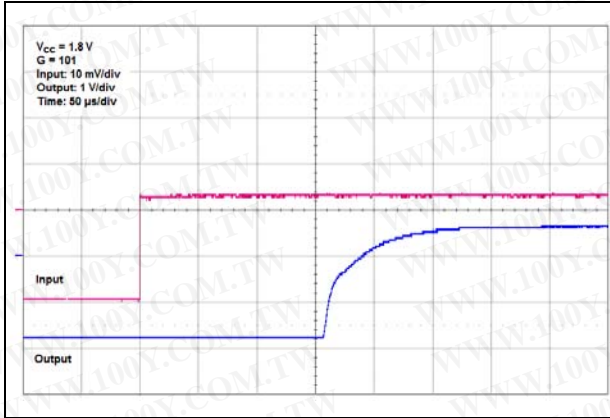

Figure 27. Positive overvoltage recovery at  $V_{CC} = 5\text{ V}$

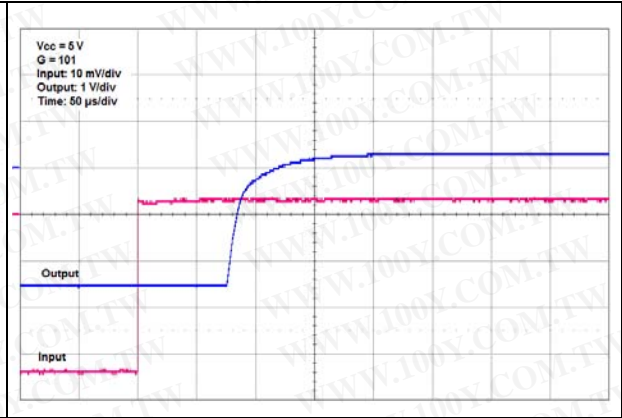

Figure 28. Negative overvoltage recovery at  $V_{CC} = 1.8\text{ V}$

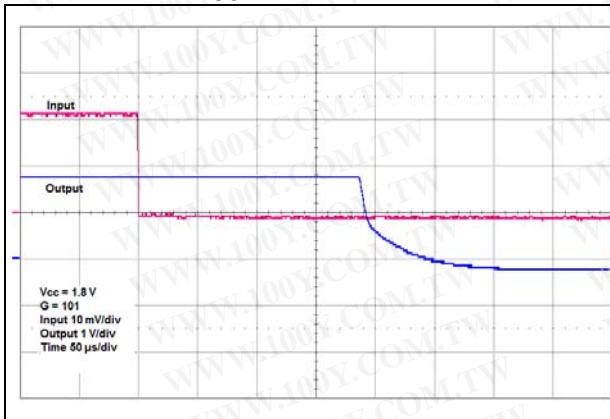

Figure 29. Negative overvoltage recovery at  $V_{CC} = 5\text{ V}$

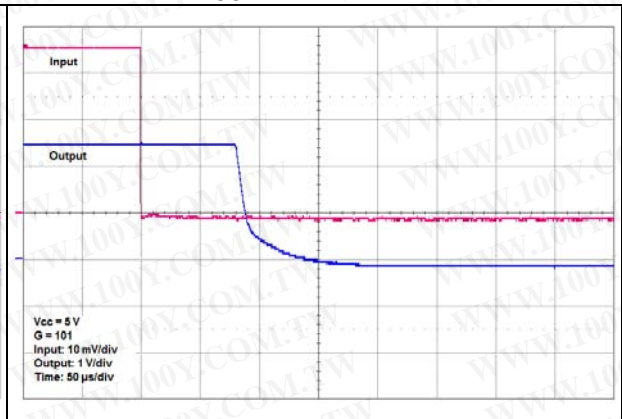

Figure 30.  $V_{OH}$  vs. supply voltage

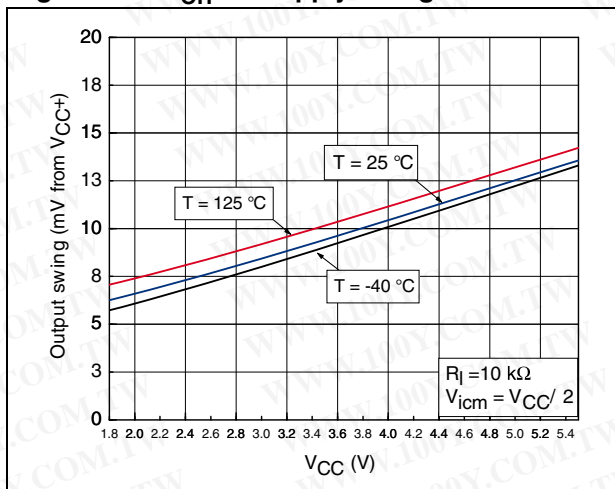

Figure 31.  $V_{OL}$  vs. supply voltage

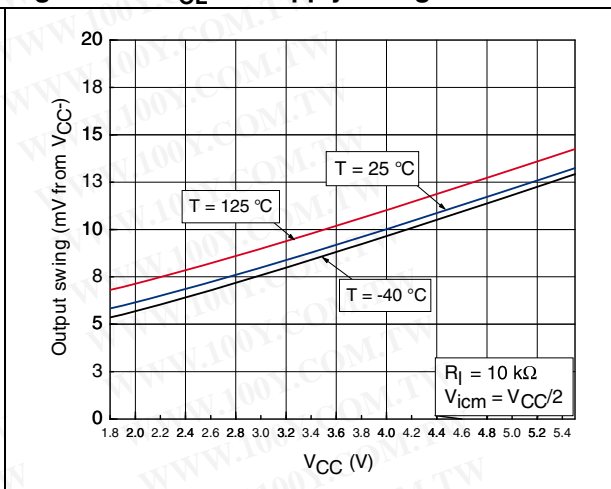

Figure 32. PSRR vs. frequency

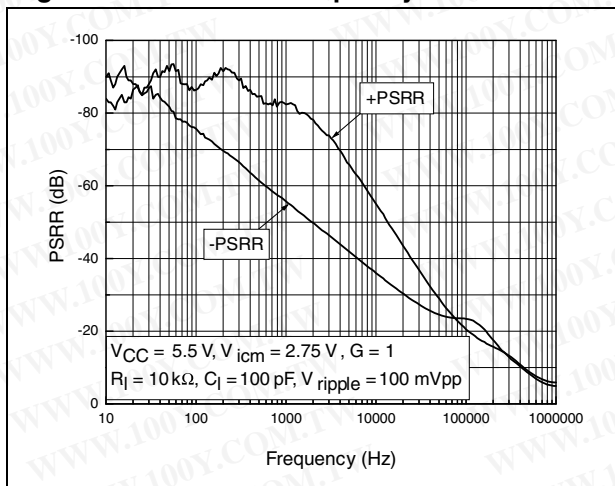

Figure 33. Input bias currents vs. temperature

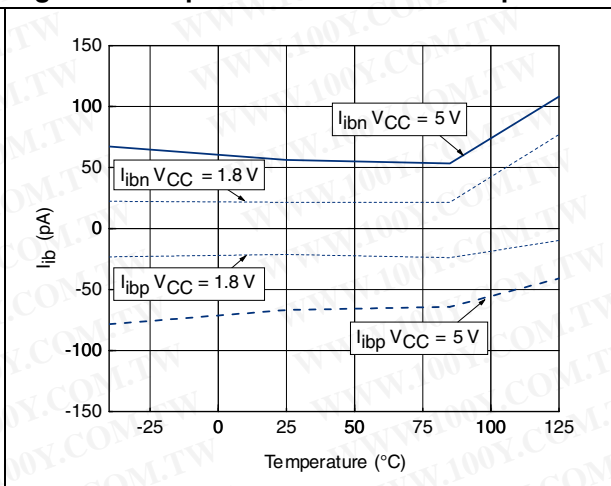

Figure 34. Positive slew rate vs. supply voltage

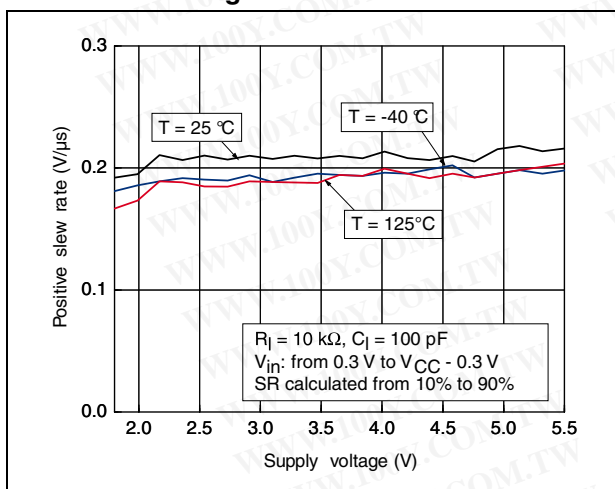
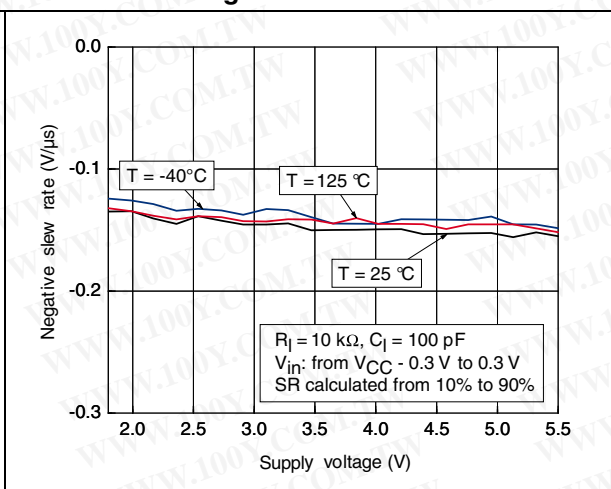

Figure 35. Negative slew rate vs. supply voltage



## 4 Application information

### 4.1 Theory of operation

The TSZ121 device is a high precision CMOS achieving a low offset drift and no  $1/f$  noise, thanks to chopper architecture. Chopper-stabilized amps constantly correct low-frequency errors across the inputs of the amplifier.

#### How a chopper-stabilized amplifier works

There are two approaches to understanding the basic chopper technique; the time domain and the frequency domain.

#### 4.1.1 Time domain

The basis of the chopper amplifier is realized in two steps. These steps are synchronized thanks to a clock running at 400 kHz.

**Figure 36. Block diagram in the time domain (step 1)**

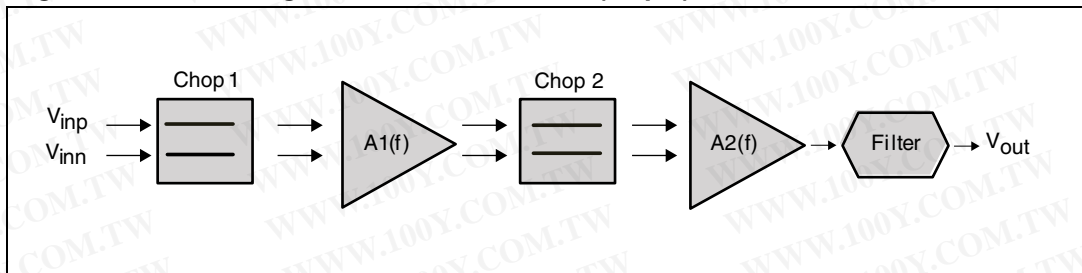

**Figure 37. Block diagram in the time domain (step 2)**

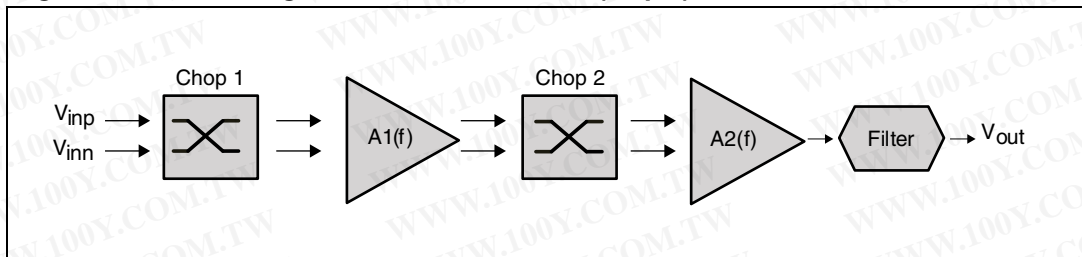

First, the  $V_{io}$  is amplified in a normal way during step 1 described in [Figure 36](#).

Next, on the second clock cycle, Chop1 and Chop2 invert the path as described by step 2 in [Figure 37](#). So at this time the  $V_{io}$  is amplified in a reverse way as compared to step 1.

At the end of these two steps, the average  $V_{io}$  is close to zero.

The  $A2(f)$  amplifier has a small impact on the  $V_{io}$ , as the  $V_{io}$  is expressed as the input offset, so divided by  $A1(f)$ .



In the time domain the offset part of the output signal before filtering is represented by [Figure 38](#).

**Figure 38.  $V_{io}$  cancellation principle**

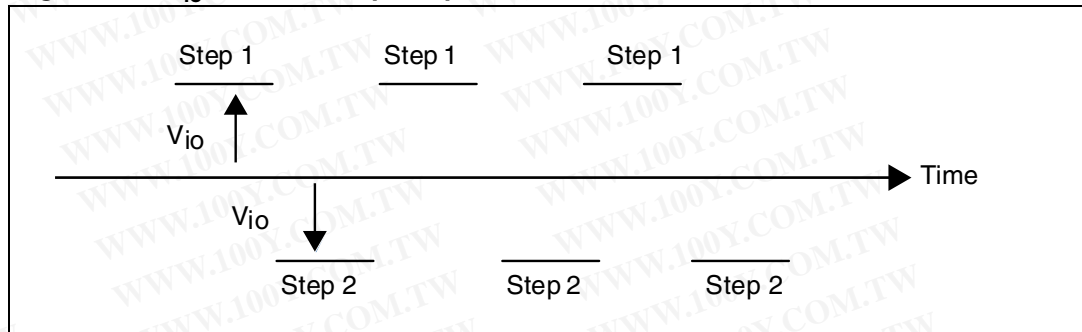

Then, the low pass filter averages the output value resulting in a null  $V_{io}$  offset.

The  $1/f$  noise can be considered as an offset in low frequency and it is nulled like the  $V_{io}$ , thanks to the chopper technique.

### 4.1.2 Frequency domain

The chopper basic techniques can also be explained in the frequency domain, which gives a more accurate vision of the architecture.

**Figure 39. Block diagram in the frequency domain**

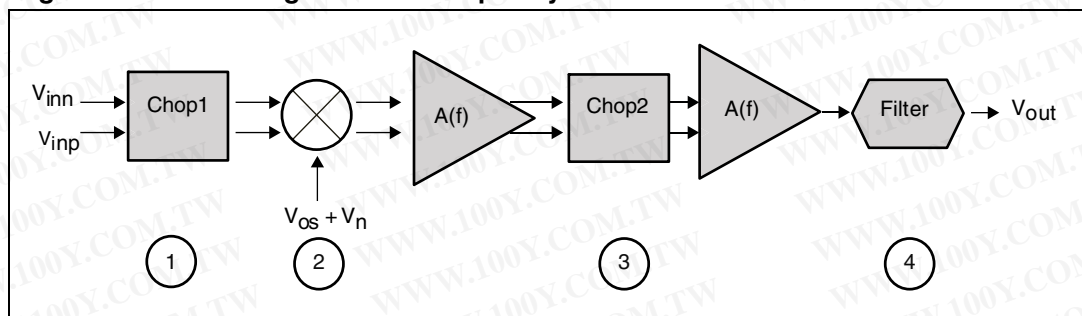

The modulation technique is to transpose the signal to a higher frequency where there is no  $1/f$  noise, and then demodulate it back after amplification.

1. According to [Figure 39](#),  $V_{in}$  is modulated one time (Chop1) so all the input signal is transposed in high frequency domain.
2. The amplifier adds its own error ( $V_{io}$  (output offset voltage) + the noise  $V_n$  ( $1/f$  noise)) to this modulated signal.
3. This signal is then demodulated (Chop2), but since the noise and the offset are modulated only once, they are transposed to the high frequency, leaving the output signal of the amplifier without any offset and low frequency noise. So the input signal is amplified with a very low offset and  $1/f$  noise.
4. To get rid of the high frequency part of the output signal (which is useless) a low pass filter is implemented.

To further suppress the remaining ripple down to a desired level, another low pass filter may be added externally on the output of the TSZ121 device.



## 4.2 Operating voltages

The TSZ12x device can operate from 1.8 to 5.5 V. The parameters are fully specified for 1.8, 3.3 and 5 V power supplies. However, the parameters are very stable in the full  $V_{CC}$  range and several characterization curves show the TSZ12x device characteristics at 1.8 V. Additionally, the main specifications are guaranteed in extended temperature ranges from -40 to +125 °C.

## 4.3 Input pins voltage range

The TSZ121 device has internal ESD diode protection on the inputs. These diodes are connected between the input and each supply rail to protect the input MOSFETs from electrical discharge.

If the input pin voltage exceeds the power supply by 0.5 V, the ESD diodes become conductive and excessive current can flow through them, and without limitation this overcurrent can damage the device.

In this case, it is important to limit the current to 10 mA, thanks to an added resistance on the input pin, as described in [Figure 40](#).

**Figure 40. Input current limitation**

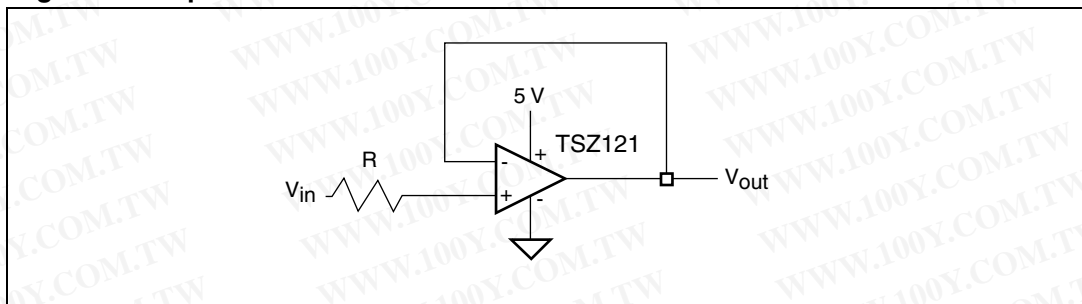

## 4.4 Rail-to-rail input

The TSZ12x device has a rail-to-rail input, and the input common mode range is extended from  $V_{CC-} - 0.1$  V to  $V_{CC+} + 0.1$  V.

## 4.5 Input offset voltage drift over temperature

The maximum input voltage drift over temperature variation is defined as the offset variation related to offset value measured at 25 °C. The operational amplifier is one of the main circuits of the signal conditioning chain, and the amplifier input offset is a major contributor to the chain accuracy. The signal chain accuracy at 25 °C can be compensated during production at application level. The maximum input voltage drift over temperature enables the system designer to anticipate the effect of temperature variations.

The maximum input voltage drift over temperature is computed with [Equation 1](#):

### Equation 1

$$\frac{\Delta V_{io}}{\Delta T} = \max \left| \frac{V_{io}(T) - V_{io}(25^\circ \text{C})}{T - 25^\circ \text{C}} \right|$$

with T = -40 °C and 125 °C.

The datasheet maximum value is guaranteed by measurement on a representative sample size ensuring a Cpk greater than 1.3.

## 4.6 Rail-to-rail output

The operational amplifiers output levels can go close to the rails: 50 mV maximum above and below the rail when connected to a 10 kΩ resistive load to  $V_{CC}/2$ .

## 4.7 PCB layout recommendations

Particular attention must be paid to the layout of the PCB, tracks connected to the amplifier, load and power supply. The power and ground traces are critical as they must provide adequate energy and grounding for all circuits. Good practice is to use short and wide PCB traces to minimize voltage drops and parasitic inductance.

In addition, to minimize parasitic impedance over the entire surface, a multi-via technique that connects the bottom and top layer ground planes together in many locations is often used.

The copper traces that connect the output pins to the load and supply pins should be as wide as possible to minimize trace resistance.

### Optimized application recommendation

The TSZ121 device is based on chopper architecture and, being a switched device, it is strongly recommended to place a 0.1 nF + 100 nF capacitor as close as possible to the supply pins.

A good decoupling has several advantages for an application. First, it helps to reduce electromagnetic interference. Due to the modulation of the chopper, the decoupling capacitance also helps to reject the small ripple that may appear on the output.

Moreover, the decoupling capacitor improves the  $V_{io}$ ,  $I_{ib}$  parameter, as shown in [Figure 41](#) and [Figure 42](#).

**Figure 41. Influence of decoupling capacitor on  $V_{io}$  characteristics**

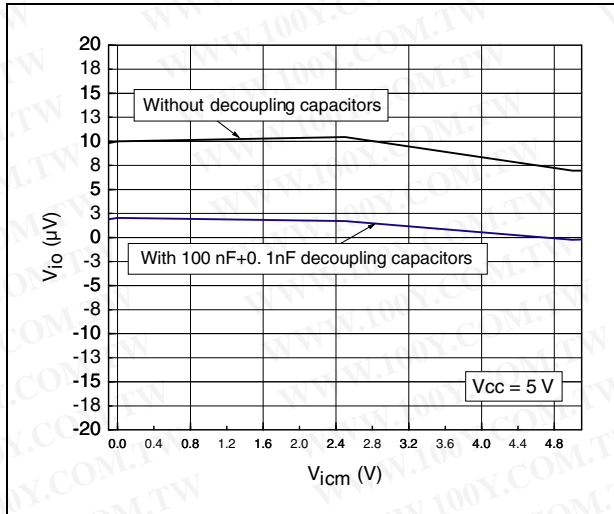

**Figure 42. Influence of decoupling capacitor on  $I_{ib}$  characteristics**

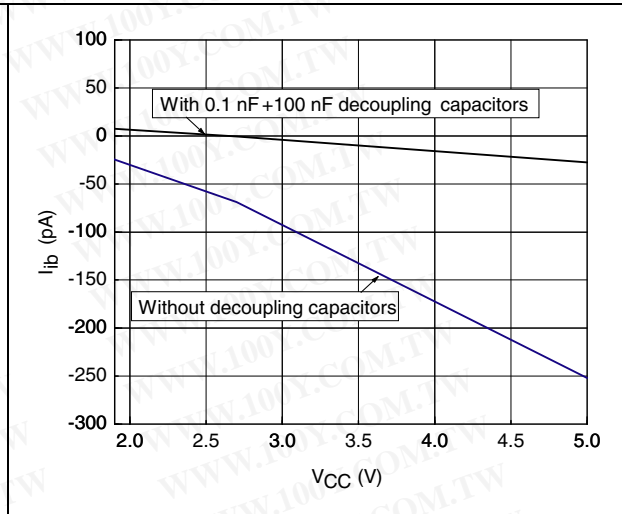

A good decoupling capacitor also improves  $\Delta V_{io}/\Delta T$ , CMRR, and SVR.

The TSZ121 device has been optimized to be used with 10 kΩ in the feedback loop gain. With this, or a higher value of resistance, the TSZ121 device offers the best performance.

## 4.8 Application examples

### 4.8.1 Oxygen sensor

The electrochemical sensor creates a current proportional to the concentration of the gas being measured. This current is converted into voltage thanks to  $R$  resistance. This voltage is then amplified by the TSZ121 device.

**Figure 43. Oxygen sensor principle schematic**

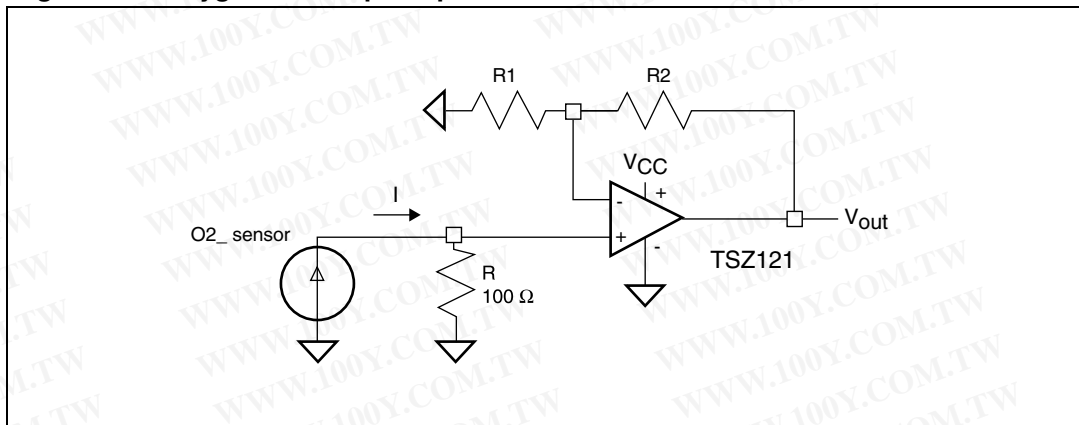

The output voltage is:

#### Equation 2

$$V_{\text{out}} = (I \times R - V_{i_o}) \times \left( \frac{R_2}{R_1} + 1 \right)$$

As the current delivered by the O2 sensor is extremely low, the impact of the  $V_{i_o}$  can become significant with a traditional operational amplifier. The use of the TSZ121 chopper amplifier, is perfect for this application.

In addition, using the TSZ121 device for the O2 sensor application ensures that the measurement of the O2 concentration is stable even at different temperature thanks to a very good  $\Delta V_{i_o} / \Delta T$ .

### 4.8.2 Precision instrumentation amplifier

The instrumentation amplifier uses three op amps. The circuit, shown in *Figure 44*, exhibits high input impedance, so that source impedance of the connected sensor has no impact on the amplification.

**Figure 44. Precision instrumentation amplifier schematic**

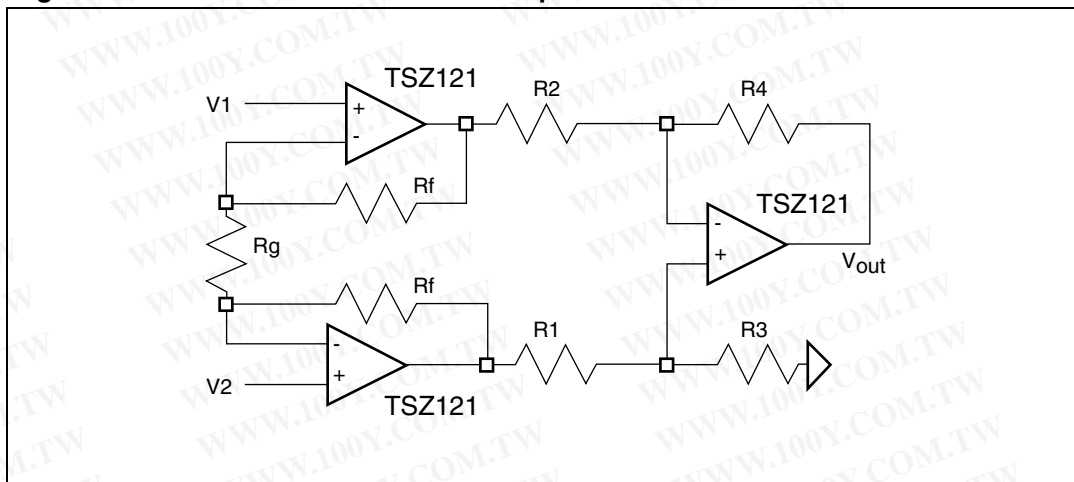

The gain is set by tuning the  $R_g$  resistor. With  $R_1=R_2$  and  $R_3=R_4$ , the output is given by the following formula:

**Equation 3**

$$V_{out} = (V_2 - V_1) \cdot \left[ \frac{R_4}{R_2} \cdot \left( \frac{2R_f}{R_g} + 1 \right) \right]$$

The matching of  $R_1$ ,  $R_2$  and  $R_3$ ,  $R_4$  is important to ensure a good CMRR.



### 4.8.3 Low-side current sensing

Power management mechanisms are found in most electronic systems. Current sensing is useful for protecting the applications. The low-side current sensing method consists in placing a sense resistor between the load and the circuit ground. The resulting voltage drop is amplified using the TSZ121 device.

**Figure 45. Low-side current sensing schematic**

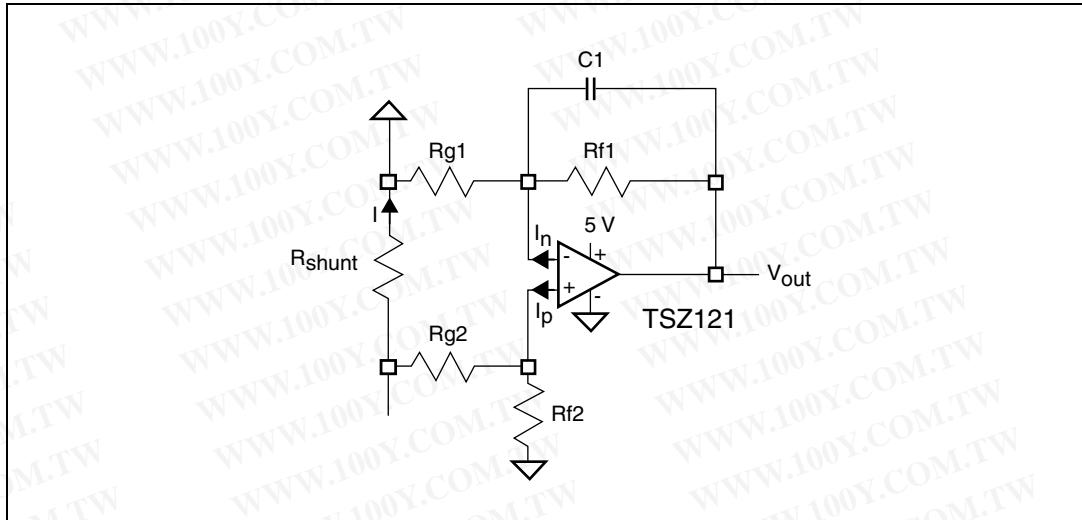

$V_{out}$  can be expressed as follows:

**Equation 4**

$$V_{out} = R_{shunt} \times I \left( 1 - \frac{R_{g2}}{R_{g2} + R_{f2}} \right) \left( 1 + \frac{R_{f1}}{R_{g1}} \right) + I_p \left( \frac{R_{g2} \times R_{f2}}{R_{g2} + R_{f2}} \right) \times \left( 1 + \frac{R_{f1}}{R_{g1}} \right) - I_n \times R_{f1} - V_{io} \left( 1 + \frac{R_{f1}}{R_{g1}} \right)$$

Assuming that  $R_{f2} = R_{f1} = R_f$  and  $R_{g2} = R_{g1} = R_g$ , the equation can be simplified as follows:

**Equation 5**

$$V_{out} = R_{shunt} \times I \left( \frac{R_f}{R_g} \right) - V_{io} \left( 1 + \frac{R_f}{R_g} \right) + R_f \times I_{io}$$

The main advantage of using the TSZ121 chopper, for a low-side current sensing, is that the error due to  $V_{io}$  and  $I_{io}$  are extremely low and may be neglected.

Therefore, for the same accuracy, the shunt resistor can be chosen with a lower value, resulting in lower power dissipation, lower drop in the ground path and lower cost.

Particular attention must be paid on the matching and precision of  $R_{g1}$ ,  $R_{g2}$ ,  $R_{f1}$ , and  $R_{f2}$ , to maximize the accuracy of the measurement.

## 5 Package information

In order to meet environmental requirements, ST offers these devices in different grades of ECOPACK® packages, depending on their level of environmental compliance. ECOPACK specifications, grade definitions and product status are available at: [www.st.com](http://www.st.com). ECOPACK is an ST trademark.

Figure 46. SC70-5 package outline

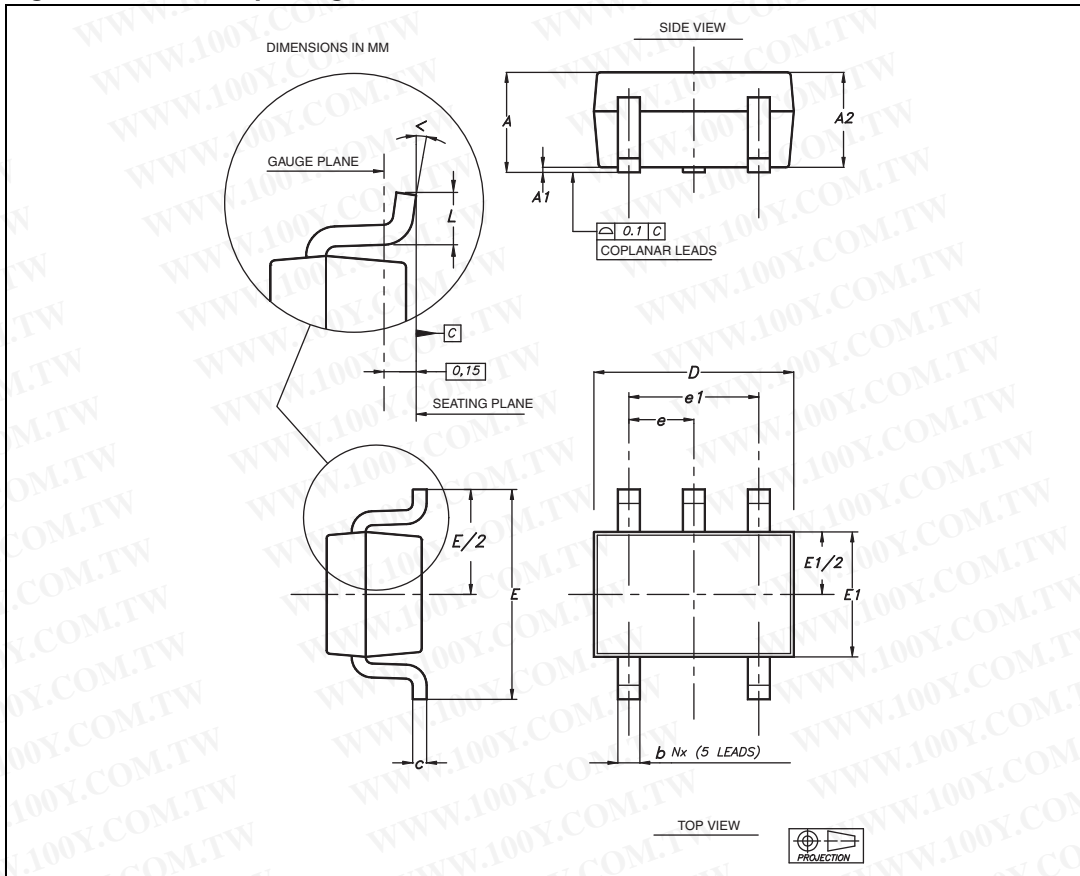

Table 6. SC70-5 package mechanical data

Symbol	Dimensions					
	Millimeters			Inches		
	Min.	Typ.	Max.	Min.	Typ.	Max.
<b>A</b>	0.80		1.10	0.032		0.043
<b>A1</b>	0		0.10			0.004
<b>A2</b>	0.80	0.90	1.00	0.032	0.035	0.039
<b>b</b>	0.15		0.30	0.006		0.012
<b>c</b>	0.10		0.22	0.004		0.009
<b>D</b>	1.80	2.00	2.20	0.071	0.079	0.087
<b>E</b>	1.80	2.10	2.40	0.071	0.083	0.094
<b>E1</b>	1.15	1.25	1.35	0.045	0.049	0.053
<b>e</b>		0.65			0.025	
<b>e1</b>		1.30			0.051	
<b>L</b>	0.26	0.36	0.46	0.010	0.014	0.018
<b>&lt;</b>	0°		8°			

Figure 47. SOT23 - 5-lead small outline transistor package outline

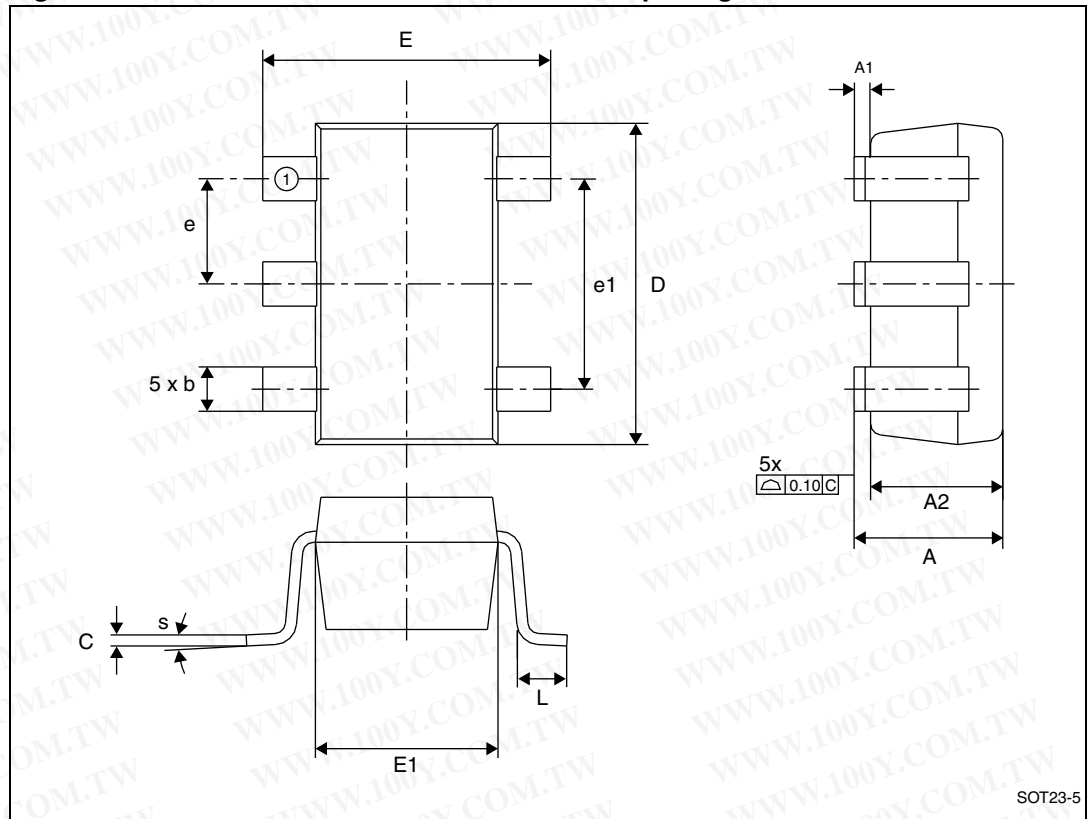
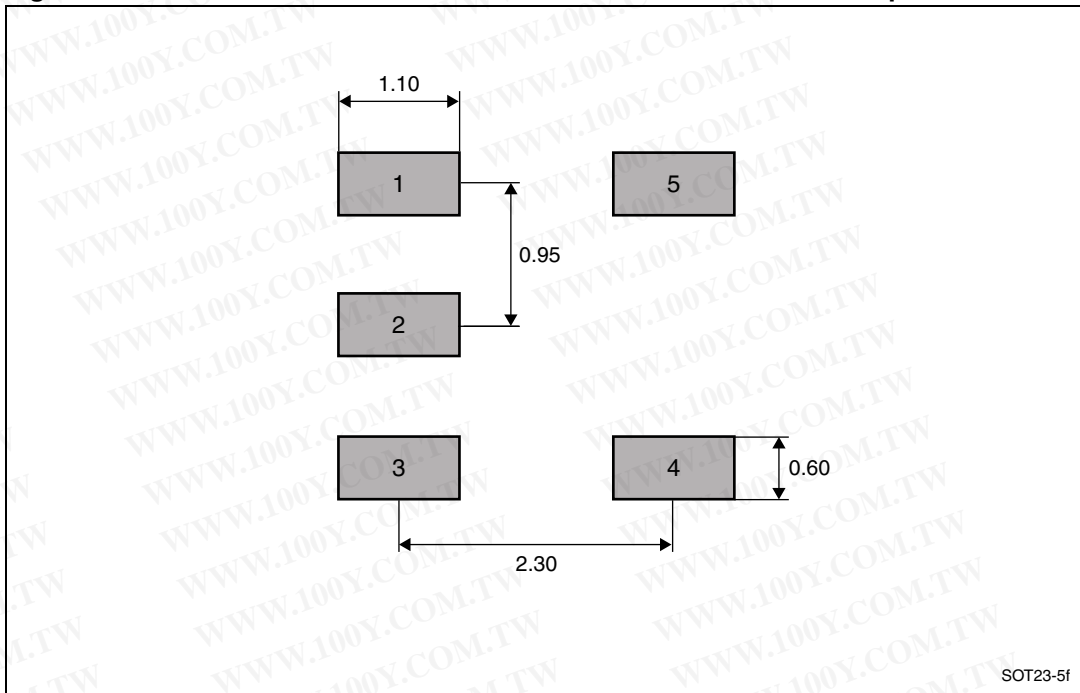

Table 7. SOT23 - 5-lead small outline transistor package mechanical data

Symbol	Dimensions						
	Millimeters			Inches			
	Typ.	Min.	Max.	Typ.	Min.	Max.	
A			1.45			0.057	
A1		0.00	0.15		0.000	0.006	
A2	1.15	0.90	1.30	0.045	0.035	0.051	
b		0.30	0.50		0.012	0.020	
c		0.08	0.22		0.003	0.009	
D	2.90			0.114			
E	2.80			0.110			
E1	1.60			0.063			
e	0.95			0.037			
e1	1.90			0.075			
L	0.45	0.30	0.60	0.018	0.012	0.024	
θ	4	0	8	4	0	8	
N		5				5	

Figure 48. SOT23 - 5-lead small outline transistor recommended footprint



SOT23-5f



## 6 Ordering information

**Table 8. Order codes**

Order code	Temperature range	Package	Packaging	Marking
TSZ121ICT	-40 to +125 °C	SC70-5	Tape and reel	K44
TSZ121ILT		SOT23-5		K143

## 7 Revision history

**Table 9. Document revision history**

Date	Revision	Changes
16-Aug-2012	1	Initial release.

勝特力材料 886-3-5753170  
勝特力电子(上海) 86-21-34970699  
勝特力电子(深圳) 86-755-83298787  
[Http://www.100y.com.tw](http://www.100y.com.tw)

**Please Read Carefully:**

Information in this document is provided solely in connection with ST products. STMicroelectronics NV and its subsidiaries ("ST") reserve the right to make changes, corrections, modifications or improvements, to this document, and the products and services described herein at any time, without notice.

All ST products are sold pursuant to ST's terms and conditions of sale.

Purchasers are solely responsible for the choice, selection and use of the ST products and services described herein, and ST assumes no liability whatsoever relating to the choice, selection or use of the ST products and services described herein.

No license, express or implied, by estoppel or otherwise, to any intellectual property rights is granted under this document. If any part of this document refers to any third party products or services it shall not be deemed a license grant by ST for the use of such third party products or services, or any intellectual property contained therein or considered as a warranty covering the use in any manner whatsoever of such third party products or services or any intellectual property contained therein.

**UNLESS OTHERWISE SET FORTH IN ST'S TERMS AND CONDITIONS OF SALE ST DISCLAIMS ANY EXPRESS OR IMPLIED WARRANTY WITH RESPECT TO THE USE AND/OR SALE OF ST PRODUCTS INCLUDING WITHOUT LIMITATION IMPLIED WARRANTIES OF MERCHANTABILITY, FITNESS FOR A PARTICULAR PURPOSE (AND THEIR EQUIVALENTS UNDER THE LAWS OF ANY JURISDICTION), OR INFRINGEMENT OF ANY PATENT, COPYRIGHT OR OTHER INTELLECTUAL PROPERTY RIGHT.**

**UNLESS EXPRESSLY APPROVED IN WRITING BY TWO AUTHORIZED ST REPRESENTATIVES, ST PRODUCTS ARE NOT RECOMMENDED, AUTHORIZED OR WARRANTED FOR USE IN MILITARY, AIR CRAFT, SPACE, LIFE SAVING, OR LIFE SUSTAINING APPLICATIONS, NOR IN PRODUCTS OR SYSTEMS WHERE FAILURE OR MALFUNCTION MAY RESULT IN PERSONAL INJURY, DEATH, OR SEVERE PROPERTY OR ENVIRONMENTAL DAMAGE. ST PRODUCTS WHICH ARE NOT SPECIFIED AS "AUTOMOTIVE GRADE" MAY ONLY BE USED IN AUTOMOTIVE APPLICATIONS AT USER'S OWN RISK.**

Resale of ST products with provisions different from the statements and/or technical features set forth in this document shall immediately void any warranty granted by ST for the ST product or service described herein and shall not create or extend in any manner whatsoever, any liability of ST.

ST and the ST logo are trademarks or registered trademarks of ST in various countries.

Information in this document supersedes and replaces all information previously supplied.

The ST logo is a registered trademark of STMicroelectronics. All other names are the property of their respective owners.

© 2012 STMicroelectronics - All rights reserved

STMicroelectronics group of companies

Australia - Belgium - Brazil - Canada - China - Czech Republic - Finland - France - Germany - Hong Kong - India - Israel - Italy - Japan - Malaysia - Malta - Morocco - Philippines - Singapore - Spain - Sweden - Switzerland - United Kingdom - United States of America

[www.st.com](http://www.st.com)