

# LM2900, LM3900 QUADRUPLE NORTON OPERATIONAL AMPLIFIERS

SLOS059 – JULY 1979 – REVISED SEPTEMBER 1990

- Wide Range of Supply Voltages, Single or Dual Supplies
- Wide Bandwidth
- Large Output Voltage Swing
- Output Short-Circuit Protection
- Internal Frequency Compensation
- Low Input Bias Current
- Designed to Be Interchangeable With National Semiconductor LM2900 and LM3900, Respectively

N PACKAGE  
(TOP VIEW)

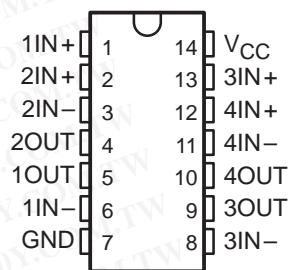

## description

These devices consist of four independent, high-gain frequency-compensated Norton operational amplifiers that were designed specifically to operate from a single supply over a wide range of voltages. Operation from split supplies is also possible. The low supply current drain is essentially independent of the magnitude of the supply voltage. These devices provide wide bandwidth and large output voltage swing.

The LM2900 is characterized for operation from  $-40^{\circ}\text{C}$  to  $85^{\circ}\text{C}$ , and the LM3900 is characterized for operation from  $0^{\circ}\text{C}$  to  $70^{\circ}\text{C}$ .

## symbol (each amplifier)

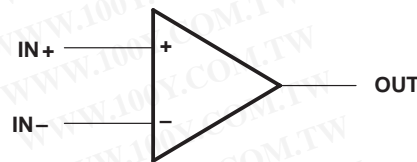

## schematic (each amplifier)

勝特力材料 886-3-5753170  
 勝特力电子(上海) 86-21-34970699  
 勝特力电子(深圳) 86-755-83298787  
[Http://www.100y.com.tw](http://www.100y.com.tw)

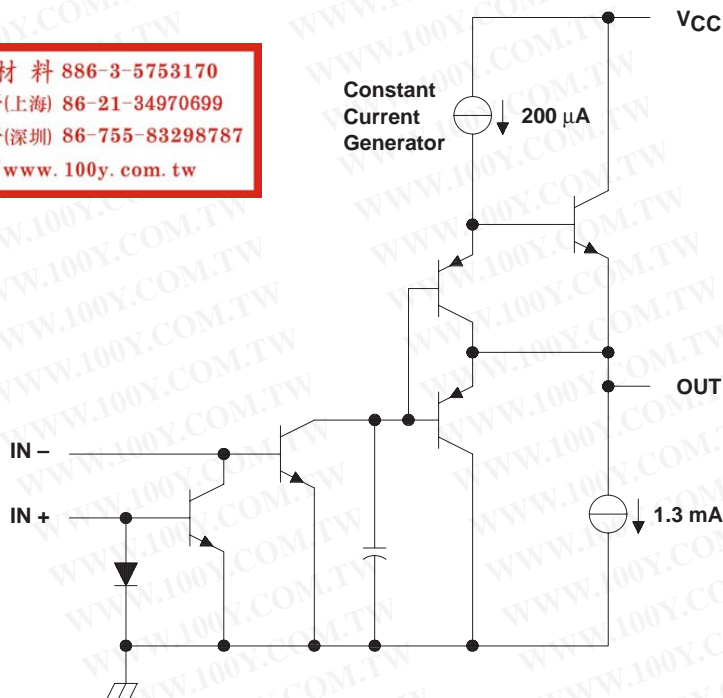

# LM2900, LM3900 QUADRUPLE NORTON OPERATIONAL AMPLIFIERS

SLOS059 – JULY 1979 – REVISED SEPTEMBER 1990

## absolute maximum ratings over operating free-air temperature range (unless otherwise noted)

	LM2900	LM3900	UNIT
Supply voltage, $V_{CC}$ (see Note 1)	36	36	V
Input current	20	20	mA
Duration of output short circuit (one amplifier) to ground at (or below) 25°C free-air temperature (see Note 2)	unlimited	unlimited	
Continuous total dissipation	See Dissipation Rating Table		
Operating free-air temperature range	-40 to 85	0 to 70	°C
Storage temperature range	-65 to 150	-65 to 150	°C
Lead temperature 1,6 mm (1/16 inch) from case for 10 seconds	260	260	°C

NOTES: 1. All voltage values, except differential voltages, are with respect to the network ground terminal.  
2. Short circuits from outputs to  $V_{CC}$  can cause excessive heating and eventual destruction.

DISSIPATION RATING TABLE

PACKAGE	$T_A \leq 25^\circ\text{C}$ POWER RATING	DERATING FACTOR ABOVE $T_A = 25^\circ\text{C}$	$T_A = 70^\circ\text{C}$ POWER RATING	$T_A = 85^\circ\text{C}$ POWER RATING
N	1150 mW	9.2 mW/°C	736 mW	598 mW

## recommended operating conditions

	LM2900		LM3900		UNIT
	MIN	MAX	MIN	MAX	
Supply voltage, $V_{CC}$ (single supply)	4.5	32	4.5	32	V
Supply voltage, $V_{CC+}$ (dual supply)	2.2	16	2.2	16	V
Supply voltage, $V_{CC-}$ (dual supply)	-2.2	-16	-2.2	-16	V
Input current (see Note 3)		-1		-1	mA
Operating free-air temperature, $T_A$	-40	85	0	70	°C

NOTE 3: Clamp transistors are included that prevent the input voltages from swinging below ground more than approximately -0.3 V. The negative input currents that may result from large signal overdrive with capacitive input coupling must be limited externally to values of approximately -1 mA. Negative input currents in excess of -4 mA causes the output voltage to drop to a low voltage. These values apply for any one of the input terminals. If more than one of the input terminals are simultaneously driven negative, maximum currents are reduced. Common-mode current biasing can be used to prevent negative input voltages.



# LM2900, LM3900 QUADRUPLE NORTON OPERATIONAL AMPLIFIERS

SLOS059 – JULY 1979 – REVISED SEPTEMBER 1990

## electrical characteristics, $V_{CC} = 15\text{ V}$ , $T_A = 25^\circ\text{C}$ (unless otherwise noted)

PARAMETER	TEST CONDITIONS†		LM2900			LM3900			UNIT
			MIN	TYP	MAX	MIN	TYP	MAX	
$I_{IB}$ Input bias current (inverting input)	$I_{I+} = 0$	$T_A = 25^\circ\text{C}$		30	200		30	200	nA
		$T_A = \text{Full range}$		300		300			
Mirror gain	$I_{I+} = 20\ \mu\text{A}$ to $200\ \mu\text{A}$ $T_A = \text{Full range}$ , See Note 4		0.9		1.1	0.9		1.1	$\mu\text{A}/\mu\text{A}$
Change in mirror gain			2%		5%	2%		5%	
Mirror current	$V_{I+} = V_{I-}$ , See Note 4			10	500		10	500	$\mu\text{A}$
$A_{VD}$ Large-signal differential voltage amplification	$V_O = 10\text{ V}$ , $f = 100\text{ Hz}$			1.2	2.8		1.2	2.8	V/mV
$r_i$ Input resistance (inverting input)				1			1		M $\Omega$
$r_o$ Output resistance				8			8		k $\Omega$
$B_1$ Unity-gain bandwidth (inverting input)				2.5			2.5		MHz
$k_{SVR}$ Supply voltage rejection ratio ( $\Delta V_{CC}/\Delta V_{IO}$ )				70			70		dB
$V_{OH}$ High-level output voltage	$I_{I+} = 0$ , $I_{I-} = 0$	$R_L = 2\text{ k}\Omega$		13.5			13.5		V
		$V_{CC} = 30\text{ V}$ , No load		29.5		29.5			
$V_{OL}$ Low-level output voltage	$I_{I+} = 0$ , $R_L = 2\text{ k}\Omega$	$I_{I-} = 10\ \mu\text{A}$		0.09	0.2		0.09	0.2	V
$I_{OS}$ Short-circuit output current (output internally high)	$I_{I+} = 0$ , $V_O = 0$	$I_{I-} = 0$		-6	-18		-6	-10	mA
Pulldown current				0.5	1.3		0.5	1.3	mA
$I_{OL}$ Low-level output current‡	$I_{I-} = 5\ \mu\text{A}$ $V_{OL} = 1\text{ V}$			5			5		mA
$I_{CC}$ Supply current (four amplifiers)	No load			6.2	10		6.2	10	mA

† All characteristics are measured under open-loop conditions with zero common-mode voltage unless otherwise specified. Full range for  $T_A$  is  $-40^\circ\text{C}$  to  $85^\circ\text{C}$  for LM2900 and  $0^\circ\text{C}$  to  $70^\circ\text{C}$  for LM3900.

‡ The output current-sink capability can be increased for large-signal conditions by overdriving the inverting input.

NOTE 4: These parameters are measured with the output balanced midway between  $V_{CC}$  and GND.

## operating characteristics, $V_{CC\pm} = \pm 15\text{ V}$ , $T_A = 25^\circ\text{C}$

PARAMETER	TEST CONDITIONS			MIN	TYP	MAX	UNIT
SR Slew rate at unity gain	Low-to-high output	$V_O = 10\text{ V}$ , $C_L = 100\text{ pF}$ , $R_L = 2\text{ k}\Omega$			0.5		V/ $\mu\text{s}$
	High-to-low output			20			



# LM2900, LM3900 QUADRUPLE NORTON OPERATIONAL AMPLIFIERS

SLOS059 – JULY 1979 – REVISED SEPTEMBER 1990

## TYPICAL CHARACTERISTICS†

INPUT BIAS CURRENT (INVERTING INPUT)  
vs  
FREE-AIR TEMPERATURE

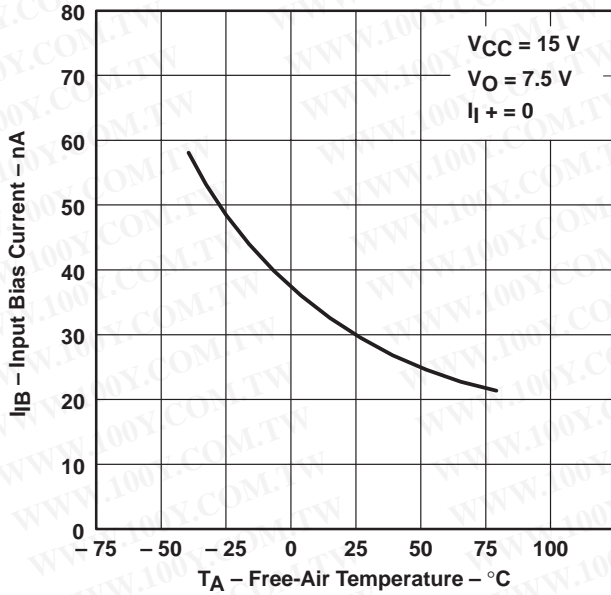

Figure 1

MIRROR GAIN  
vs  
FREE-AIR TEMPERATURE

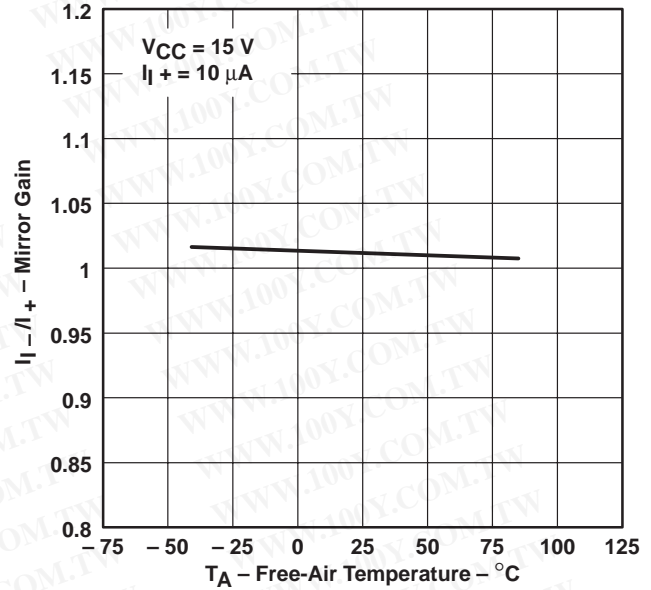

Figure 2

LARGE SIGNAL  
DIFFERENTIAL VOLTAGE AMPLIFICATION  
vs  
FREQUENCY

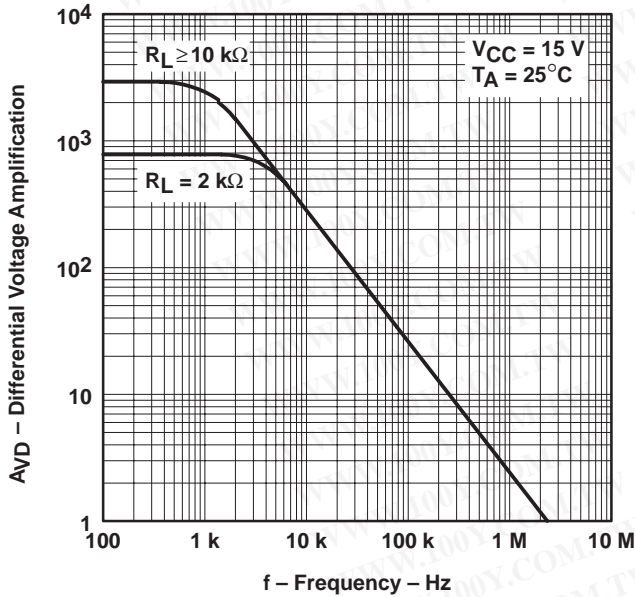

Figure 3

LARGE SIGNAL  
DIFFERENTIAL VOLTAGE AMPLIFICATION  
vs  
SUPPLY VOLTAGE

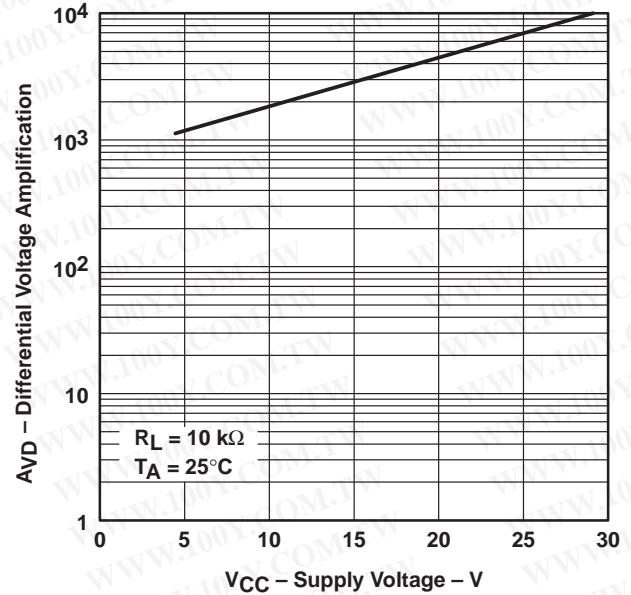

Figure 4

† Data at high and low temperatures are applicable only within the rated operating free-air temperature ranges of the various devices.



TYPICAL CHARACTERISTICS†

LARGE SIGNAL  
 DIFFERENTIAL VOLTAGE AMPLIFICATION  
 vs  
 FREE-AIR TEMPERATURE

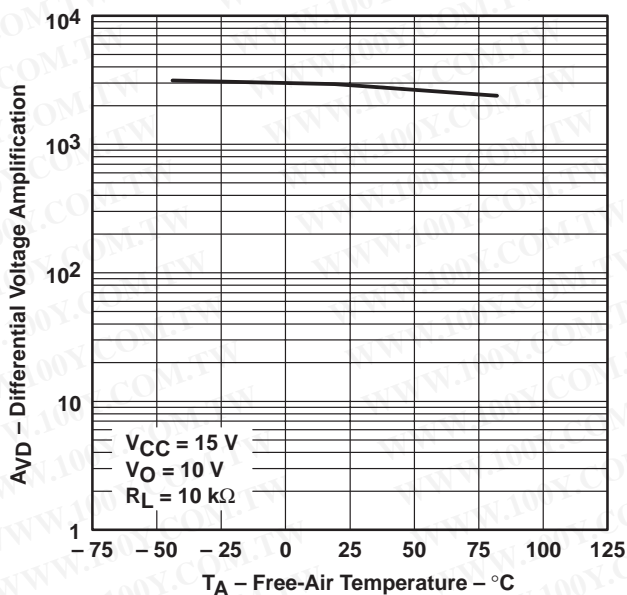

Figure 5

SUPPLY VOLTAGE REJECTION RATIO  
 vs  
 FREQUENCY

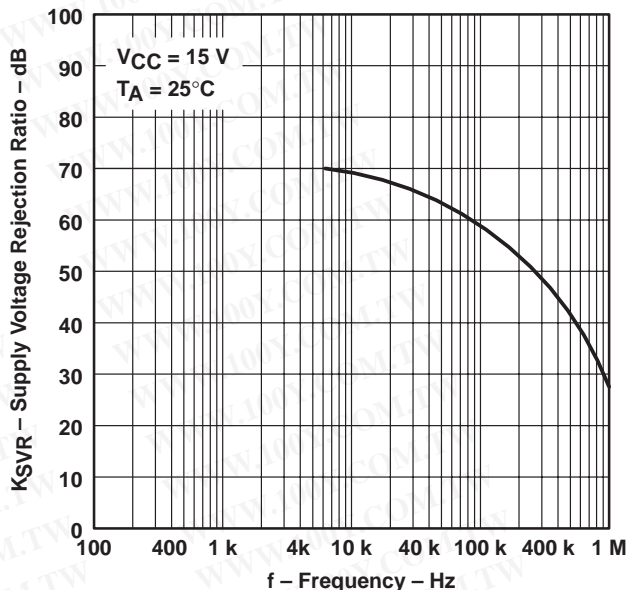

Figure 6

PEAK-TO-PEAK OUTPUT VOLTAGE  
 vs  
 FREQUENCY

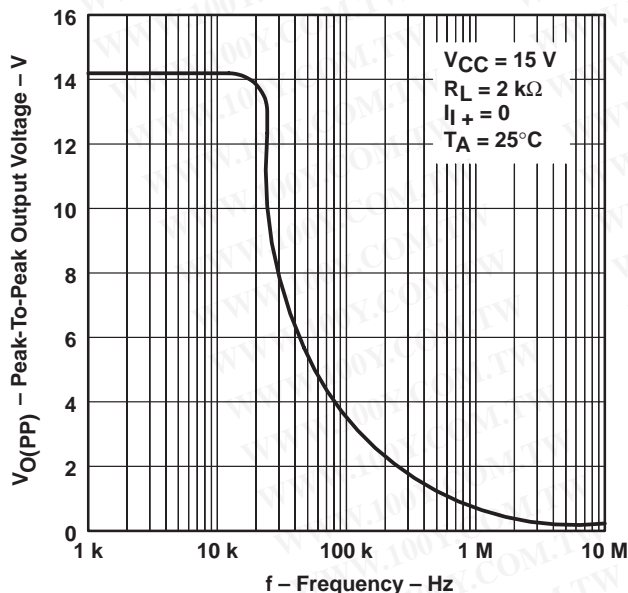

Figure 7

SHORT-CIRCUIT OUTPUT CURRENT  
 (OUTPUT INTERNALLY HIGH)  
 vs  
 SUPPLY VOLTAGE

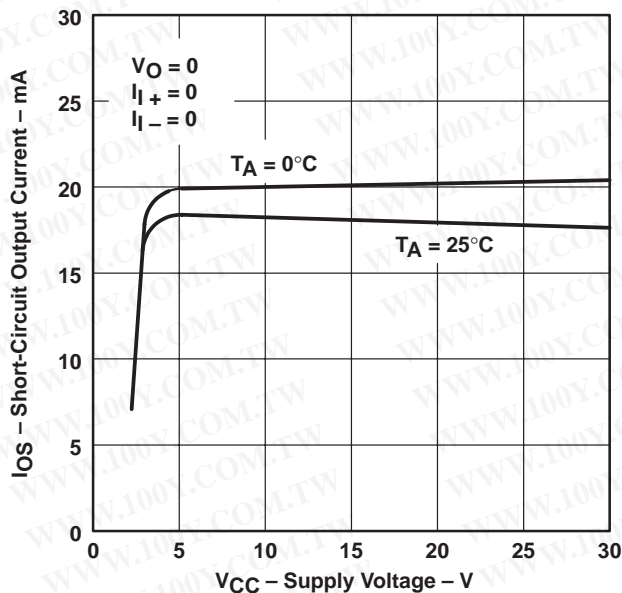

Figure 8

† Data at high and low temperatures are applicable only within the rated operating free-air temperature ranges of the various devices.

# LM2900, LM3900 QUADRUPLE NORTON OPERATIONAL AMPLIFIERS

SLOS059 – JULY 1979 – REVISED SEPTEMBER 1990

## TYPICAL CHARACTERISTICS†

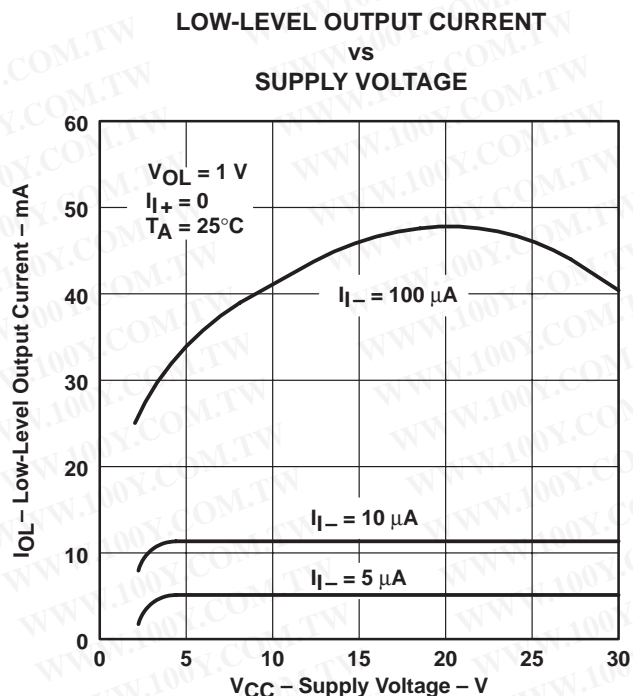

Figure 9

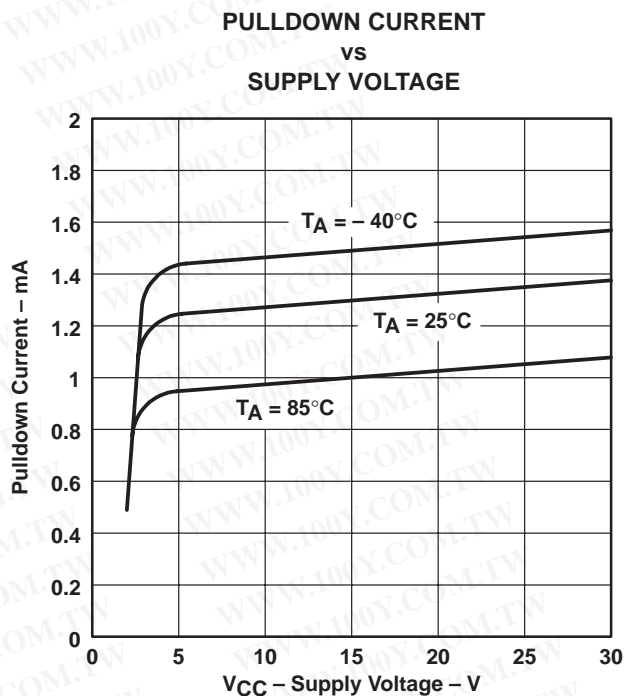

Figure 10

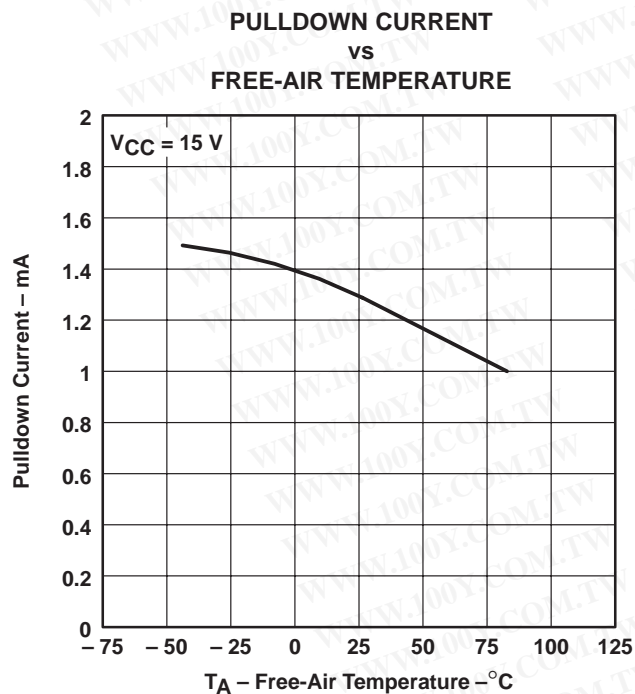

Figure 11

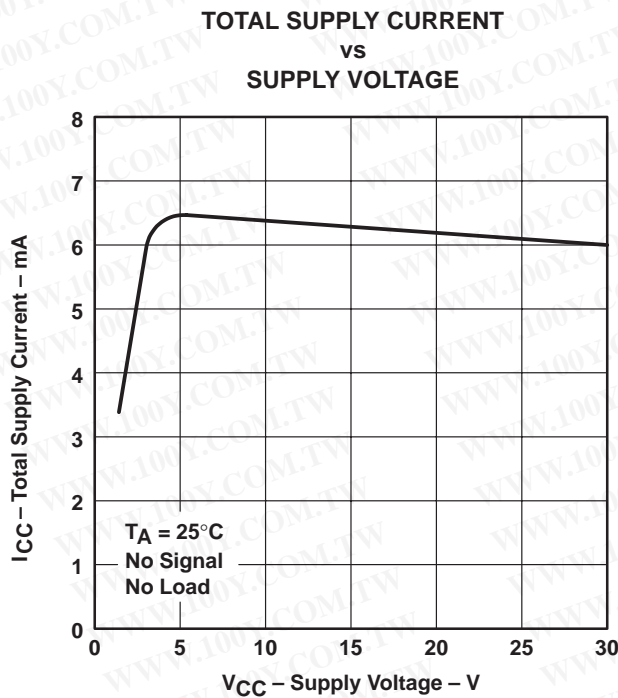

Figure 12

† Data at high and low temperatures are applicable only within the rated operating free-air temperature ranges of the various devices.

APPLICATION INFORMATION

Norton (or current-differencing) amplifiers can be used in most standard general-purpose operational amplifier applications. Performance as a dc amplifier in a single-power-supply mode is not as precise as a standard integrated-circuit operational amplifier operating from dual supplies. Operation of the amplifier can best be understood by noting that input currents are differenced at the inverting input terminal and this current then flows through the external feedback resistor to produce the output voltage. Common-mode current biasing is generally useful to allow operating with signal levels near (or even below) ground.

Internal transistors clamp negative input voltages at approximately  $-0.3\text{ V}$  but the magnitude of current flow has to be limited by the external input network. For operation at high temperature, this limit should be approximately  $-100\text{ }\mu\text{A}$ .

Noise immunity of a Norton amplifier is less than that of standard bipolar amplifiers. Circuit layout is more critical since coupling from the output to the noninverting input can cause oscillations. Care must also be exercised when driving either input from a low-impedance source. A limiting resistor should be placed in series with the input lead to limit the peak input current. Current up to  $20\text{ mA}$  will not damage the device, but the current mirror on the noninverting input will saturate and cause a loss of mirror gain at higher current levels, especially at high operating temperatures.

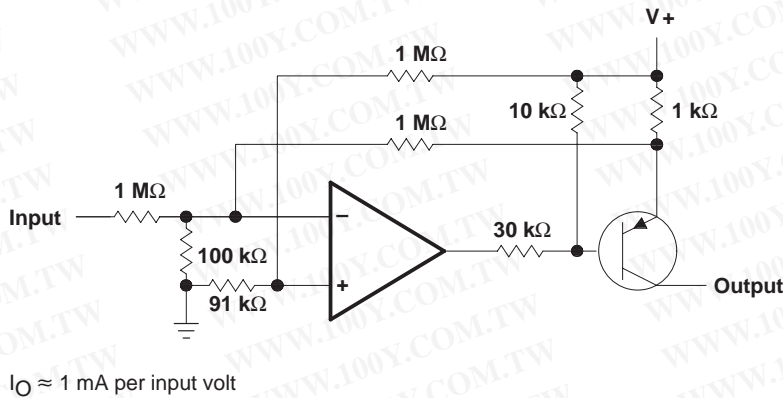

Figure 13. Voltage-Controlled Current Source

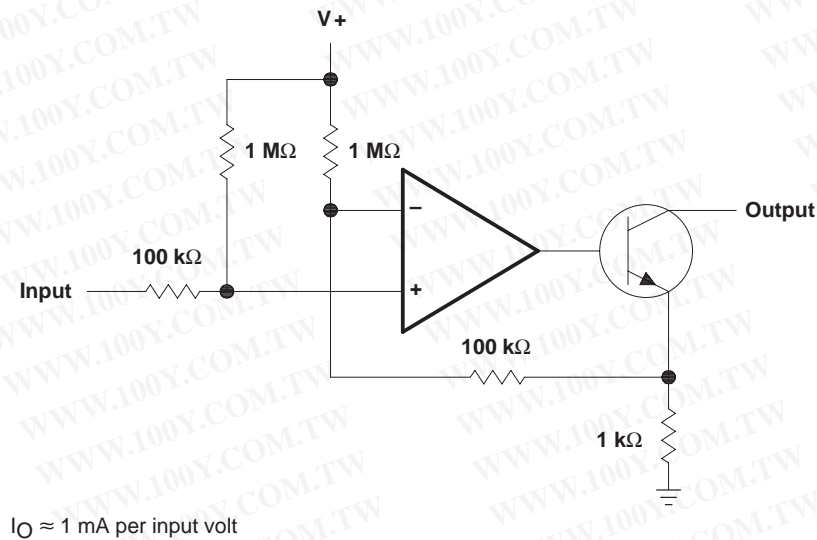

Figure 14. Voltage-Controlled Current Sink

**PACKAGING INFORMATION**

Orderable Device	Status (1)	Package Type	Package Drawing	Pins	Package Qty	Eco Plan (2)	Lead/Ball Finish (6)	MSL Peak Temp (3)	Op Temp (°C)	Device Marking (4/5)	Samples
LM2900D	ACTIVE	SOIC	D	14	50	Green (RoHS & no Sb/Br)	CU NIPDAU	Level-1-260C-UNLIM	-40 to 85	LM2900	<a href="#">Samples</a>
LM2900DR	ACTIVE	SOIC	D	14	2500	Green (RoHS & no Sb/Br)	CU NIPDAU	Level-1-260C-UNLIM	-40 to 85	LM2900	<a href="#">Samples</a>
LM2900DR	ACTIVE	SOIC	D	14	2500	Green (RoHS & no Sb/Br)	CU NIPDAU	Level-1-260C-UNLIM	-40 to 85	LM2900	<a href="#">Samples</a>
LM2900DR	ACTIVE	SOIC	D	14	2500	Green (RoHS & no Sb/Br)	CU NIPDAU	Level-1-260C-UNLIM	-40 to 85	LM2900	<a href="#">Samples</a>
LM2900N	ACTIVE	PDIP	N	14	25	Pb-Free (RoHS)	CU NIPDAU	N / A for Pkg Type	-40 to 85	LM2900N	<a href="#">Samples</a>
LM2900N	ACTIVE	PDIP	N	14	25	Pb-Free (RoHS)	CU NIPDAU	N / A for Pkg Type	-40 to 85	LM2900N	<a href="#">Samples</a>
LM2900N	ACTIVE	PDIP	N	14	25	Pb-Free (RoHS)	CU NIPDAU	N / A for Pkg Type	-40 to 85	LM2900N	<a href="#">Samples</a>
LM2900NE4	ACTIVE	PDIP	N	14	25	Pb-Free (RoHS)	CU NIPDAU	N / A for Pkg Type	-40 to 85	LM2900N	<a href="#">Samples</a>
LM2900NE4	ACTIVE	PDIP	N	14	25	Pb-Free (RoHS)	CU NIPDAU	N / A for Pkg Type	-40 to 85	LM2900N	<a href="#">Samples</a>
LM2900NE4	ACTIVE	PDIP	N	14	25	Pb-Free (RoHS)	CU NIPDAU	N / A for Pkg Type	-40 to 85	LM2900N	<a href="#">Samples</a>
LM3900D	ACTIVE	SOIC	D	14	50	Green (RoHS & no Sb/Br)	CU NIPDAU	Level-1-260C-UNLIM	0 to 70	LM3900	<a href="#">Samples</a>
LM3900D	ACTIVE	SOIC	D	14	50	Green (RoHS & no Sb/Br)	CU NIPDAU	Level-1-260C-UNLIM	0 to 70	LM3900	<a href="#">Samples</a>
LM3900D	ACTIVE	SOIC	D	14	50	Green (RoHS & no Sb/Br)	CU NIPDAU	Level-1-260C-UNLIM	0 to 70	LM3900	<a href="#">Samples</a>
LM3900DG4	ACTIVE	SOIC	D	14	50	Green (RoHS & no Sb/Br)	CU NIPDAU	Level-1-260C-UNLIM	0 to 70	LM3900	<a href="#">Samples</a>
LM3900DG4	ACTIVE	SOIC	D	14	50	Green (RoHS & no Sb/Br)	CU NIPDAU	Level-1-260C-UNLIM	0 to 70	LM3900	<a href="#">Samples</a>
LM3900DG4	ACTIVE	SOIC	D	14	50	Green (RoHS & no Sb/Br)	CU NIPDAU	Level-1-260C-UNLIM	0 to 70	LM3900	<a href="#">Samples</a>
LM3900DR	ACTIVE	SOIC	D	14	2500	Green (RoHS & no Sb/Br)	CU NIPDAU	Level-1-260C-UNLIM	0 to 70	LM3900	<a href="#">Samples</a>



Orderable Device	Status (1)	Package Type	Package Drawing	Pins	Package Qty	Eco Plan (2)	Lead/Ball Finish (6)	MSL Peak Temp (3)	Op Temp (°C)	Device Marking (4/5)	Samples
LM3900DR	ACTIVE	SOIC	D	14	2500	Green (RoHS & no Sb/Br)	CU NIPDAU	Level-1-260C-UNLIM	0 to 70	LM3900	<a href="#">Samples</a>
LM3900DR	ACTIVE	SOIC	D	14	2500	Green (RoHS & no Sb/Br)	CU NIPDAU	Level-1-260C-UNLIM	0 to 70	LM3900	<a href="#">Samples</a>
LM3900N	ACTIVE	PDIP	N	14	25	Pb-Free (RoHS)	CU NIPDAU	N / A for Pkg Type	0 to 70	LM3900N	<a href="#">Samples</a>
LM3900N	ACTIVE	PDIP	N	14	25	Pb-Free (RoHS)	CU NIPDAU	N / A for Pkg Type	0 to 70	LM3900N	<a href="#">Samples</a>
LM3900N	ACTIVE	PDIP	N	14	25	Pb-Free (RoHS)	CU NIPDAU	N / A for Pkg Type	0 to 70	LM3900N	<a href="#">Samples</a>
LM3900NE4	ACTIVE	PDIP	N	14	25	Pb-Free (RoHS)	CU NIPDAU	N / A for Pkg Type	0 to 70	LM3900N	<a href="#">Samples</a>
LM3900NE4	ACTIVE	PDIP	N	14	25	Pb-Free (RoHS)	CU NIPDAU	N / A for Pkg Type	0 to 70	LM3900N	<a href="#">Samples</a>
LM3900NE4	ACTIVE	PDIP	N	14	25	Pb-Free (RoHS)	CU NIPDAU	N / A for Pkg Type	0 to 70	LM3900N	<a href="#">Samples</a>

(1) The marketing status values are defined as follows:

**ACTIVE:** Product device recommended for new designs.

**LIFEBUY:** TI has announced that the device will be discontinued, and a lifetime-buy period is in effect.

**NRND:** Not recommended for new designs. Device is in production to support existing customers, but TI does not recommend using this part in a new design.

**PREVIEW:** Device has been announced but is not in production. Samples may or may not be available.

**OBSELETE:** TI has discontinued the production of the device.

(2) Eco Plan - The planned eco-friendly classification: Pb-Free (RoHS), Pb-Free (RoHS Exempt), or Green (RoHS & no Sb/Br) - please check <http://www.ti.com/productcontent> for the latest availability information and additional product content details.

**TBD:** The Pb-Free/Green conversion plan has not been defined.

**Pb-Free (RoHS):** TI's terms "Lead-Free" or "Pb-Free" mean semiconductor products that are compatible with the current RoHS requirements for all 6 substances, including the requirement that lead not exceed 0.1% by weight in homogeneous materials. Where designed to be soldered at high temperatures, TI Pb-Free products are suitable for use in specified lead-free processes.

**Pb-Free (RoHS Exempt):** This component has a RoHS exemption for either 1) lead-based flip-chip solder bumps used between the die and package, or 2) lead-based die adhesive used between the die and leadframe. The component is otherwise considered Pb-Free (RoHS compatible) as defined above.

**Green (RoHS & no Sb/Br):** TI defines "Green" to mean Pb-Free (RoHS compatible), and free of Bromine (Br) and Antimony (Sb) based flame retardants (Br or Sb do not exceed 0.1% by weight in homogeneous material)

(3) MSL, Peak Temp. - The Moisture Sensitivity Level rating according to the JEDEC industry standard classifications, and peak solder temperature.

(4) There may be additional marking, which relates to the logo, the lot trace code information, or the environmental category on the device.

<sup>(5)</sup> Multiple Device Markings will be inside parentheses. Only one Device Marking contained in parentheses and separated by a "~" will appear on a device. If a line is indented then it is a continuation of the previous line and the two combined represent the entire Device Marking for that device.

<sup>(6)</sup> Lead/Ball Finish - Orderable Devices may have multiple material finish options. Finish options are separated by a vertical ruled line. Lead/Ball Finish values may wrap to two lines if the finish value exceeds the maximum column width.

**Important Information and Disclaimer:** The information provided on this page represents TI's knowledge and belief as of the date that it is provided. TI bases its knowledge and belief on information provided by third parties, and makes no representation or warranty as to the accuracy of such information. Efforts are underway to better integrate information from third parties. TI has taken and continues to take reasonable steps to provide representative and accurate information but may not have conducted destructive testing or chemical analysis on incoming materials and chemicals. TI and TI suppliers consider certain information to be proprietary, and thus CAS numbers and other limited information may not be available for release.

In no event shall TI's liability arising out of such information exceed the total purchase price of the TI part(s) at issue in this document sold by TI to Customer on an annual basis.

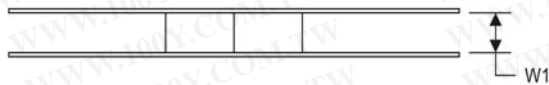
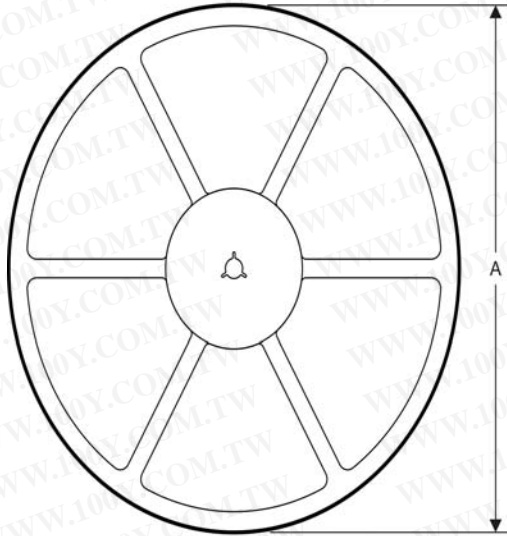
**TAPE AND REEL INFORMATION**
**REEL DIMENSIONS**

**TAPE AND REEL INFORMATION**

\*All dimensions are nominal

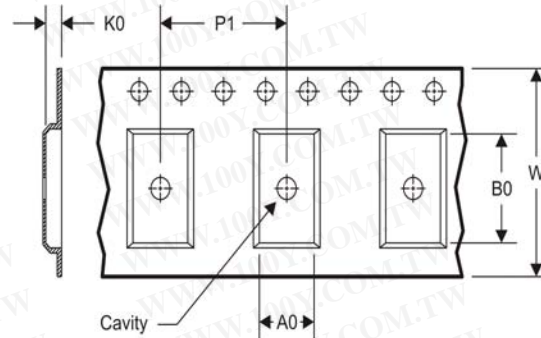
Device	Package Type	Package Drawing	Pins	SPQ	Reel Diameter (mm)	Reel Width W1 (mm)	A0 (mm)	B0 (mm)	K0 (mm)	P1 (mm)	W (mm)	Pin1 Quadrant
LM2900DR	SOIC	D	14	2500	330.0	16.4	6.5	9.0	2.1	8.0	16.0	Q1
LM3900DR	SOIC	D	14	2500	330.0	16.4	6.5	9.0	2.1	8.0	16.0	Q1

**TAPE DIMENSIONS**

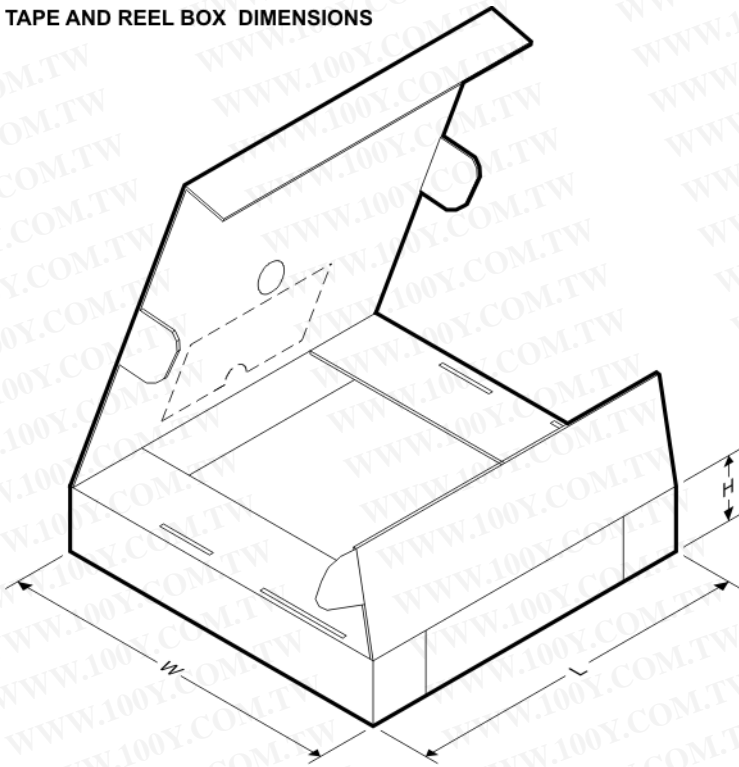
A0	Dimension designed to accommodate the component width
B0	Dimension designed to accommodate the component length
K0	Dimension designed to accommodate the component thickness
W	Overall width of the carrier tape
P1	Pitch between successive cavity centers

**TAPE AND REEL BOX DIMENSIONS**

\*All dimensions are nominal

Device	Package Type	Package Drawing	Pins	SPQ	Length (mm)	Width (mm)	Height (mm)
LM2900DR	SOIC	D	14	2500	367.0	367.0	38.0
LM3900DR	SOIC	D	14	2500	367.0	367.0	38.0



N (R-PDIP-T\*\*)

16 PINS SHOWN

PLASTIC DUAL-IN-LINE PACKAGE

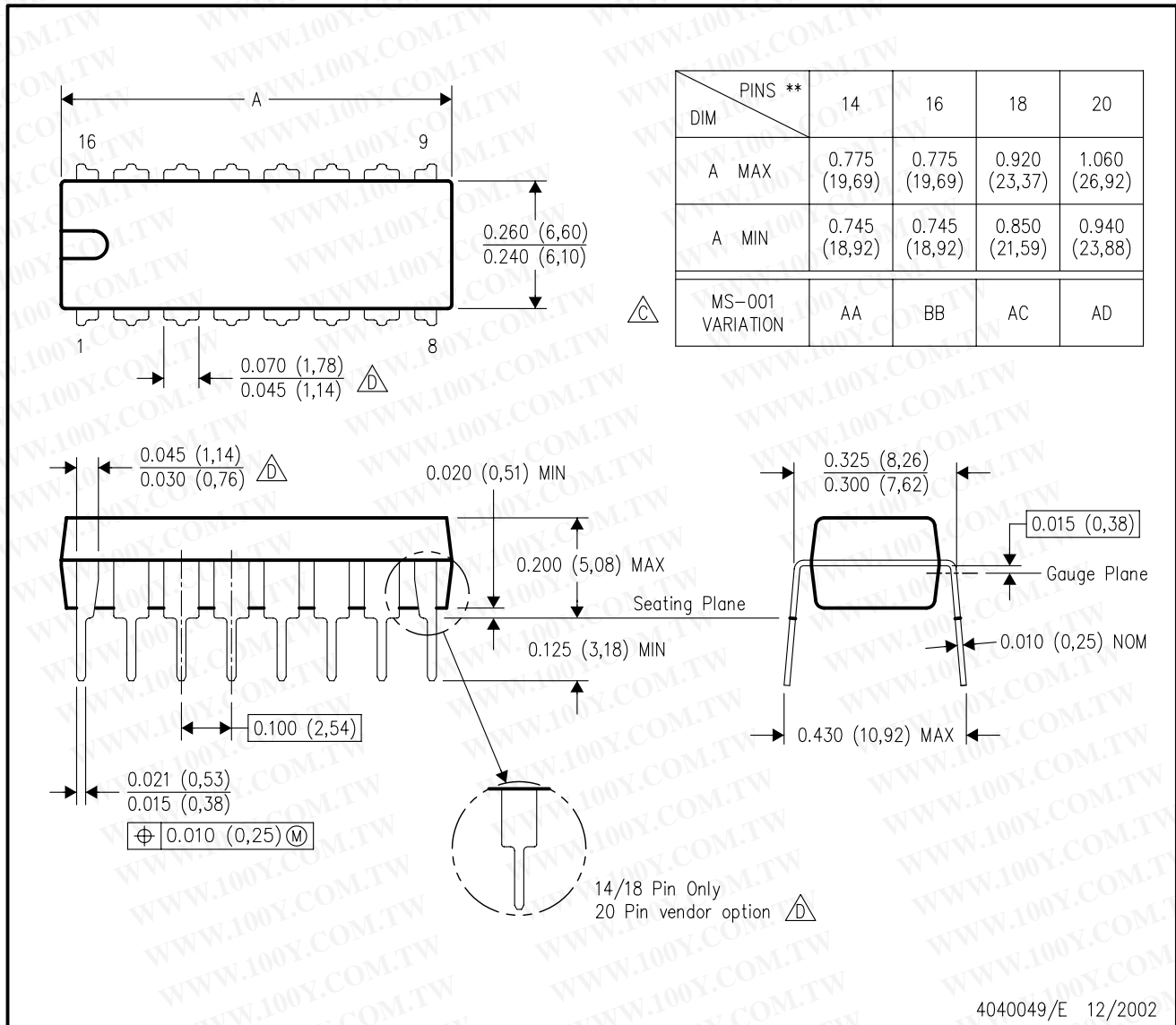

- NOTES:
- A. All linear dimensions are in inches (millimeters).
  - B. This drawing is subject to change without notice.
  - Falls within JEDEC MS-001, except 18 and 20 pin minimum body length (Dim A).
  - The 20 pin end lead shoulder width is a vendor option, either half or full width.

D (R-PDSO-G14)

PLASTIC SMALL OUTLINE

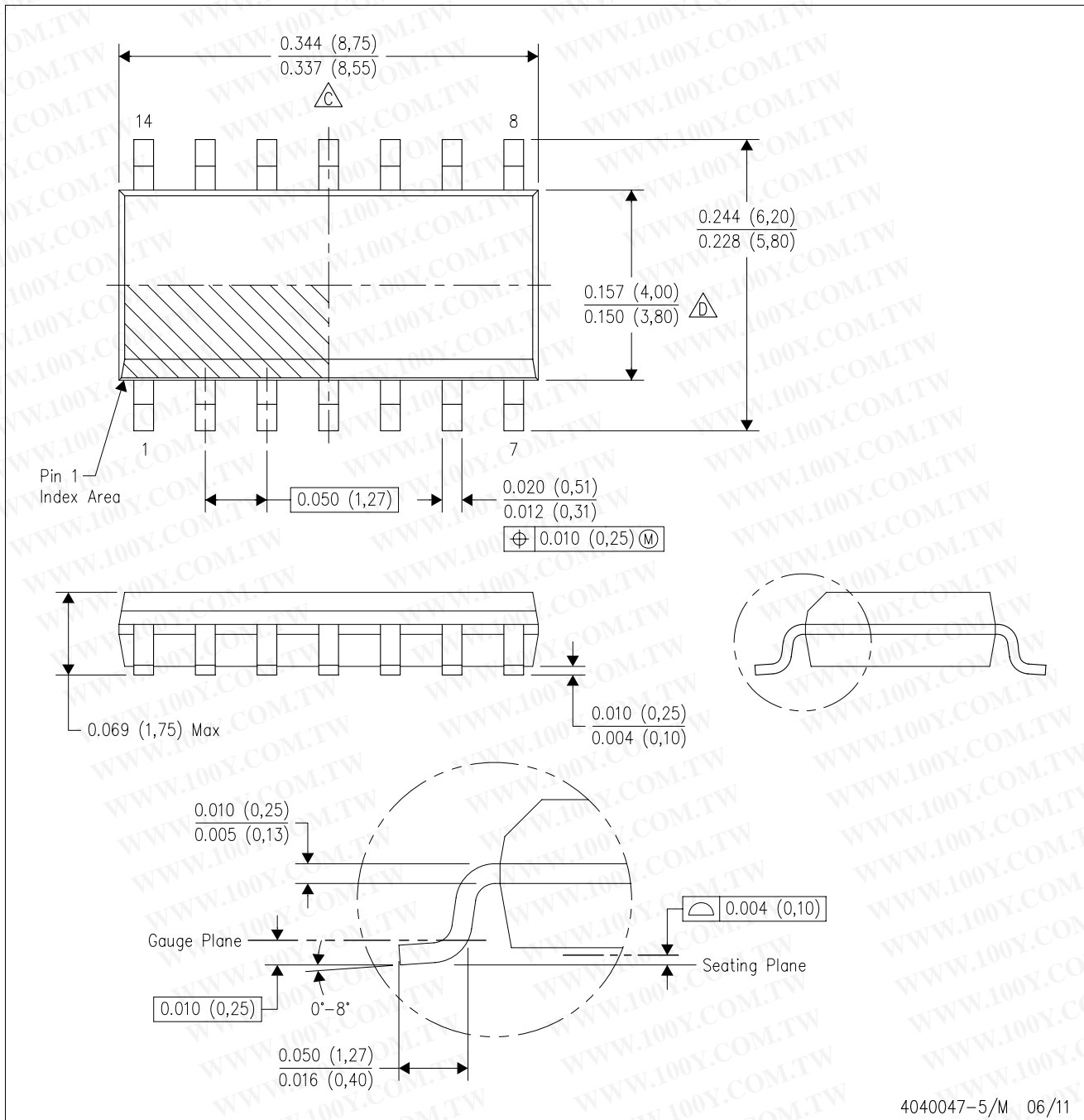

- NOTES:
- A. All linear dimensions are in inches (millimeters).
  - B. This drawing is subject to change without notice.
  - Body length does not include mold flash, protrusions, or gate burrs. Mold flash, protrusions, or gate burrs shall not exceed 0.006 (0,15) each side.
  - Body width does not include interlead flash. Interlead flash shall not exceed 0.017 (0,43) each side.
  - E. Reference JEDEC MS-012 variation AB.

D (R-PDSO-G14)

PLASTIC SMALL OUTLINE

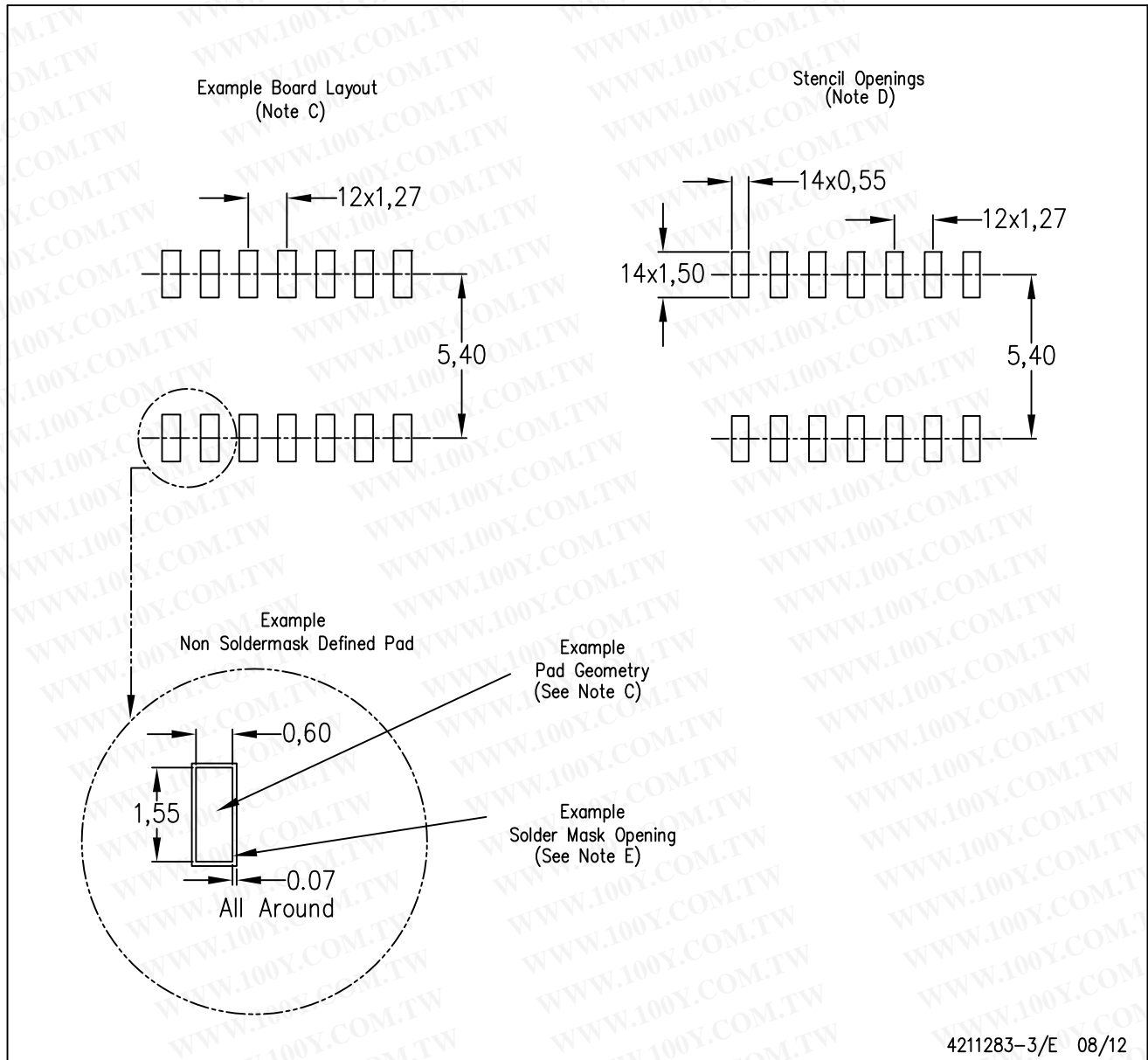

4211283-3/E 08/12

- NOTES:
- All linear dimensions are in millimeters.
  - This drawing is subject to change without notice.
  - Publication IPC-7351 is recommended for alternate designs.
  - Laser cutting apertures with trapezoidal walls and also rounding corners will offer better paste release. Customers should contact their board assembly site for stencil design recommendations. Refer to IPC-7525 for other stencil recommendations.
  - Customers should contact their board fabrication site for solder mask tolerances between and around signal pads.

勝特力材料 886-3-5753170  
勝特力电子(上海) 86-21-34970699  
勝特力电子(深圳) 86-755-83298787  
[Http://www.100y.com.tw](http://www.100y.com.tw)

## IMPORTANT NOTICE

Texas Instruments Incorporated and its subsidiaries (TI) reserve the right to make corrections, enhancements, improvements and other changes to its semiconductor products and services per JESD46, latest issue, and to discontinue any product or service per JESD48, latest issue. Buyers should obtain the latest relevant information before placing orders and should verify that such information is current and complete. All semiconductor products (also referred to herein as "components") are sold subject to TI's terms and conditions of sale supplied at the time of order acknowledgment.

TI warrants performance of its components to the specifications applicable at the time of sale, in accordance with the warranty in TI's terms and conditions of sale of semiconductor products. Testing and other quality control techniques are used to the extent TI deems necessary to support this warranty. Except where mandated by applicable law, testing of all parameters of each component is not necessarily performed.

TI assumes no liability for applications assistance or the design of Buyers' products. Buyers are responsible for their products and applications using TI components. To minimize the risks associated with Buyers' products and applications, Buyers should provide adequate design and operating safeguards.

TI does not warrant or represent that any license, either express or implied, is granted under any patent right, copyright, mask work right, or other intellectual property right relating to any combination, machine, or process in which TI components or services are used. Information published by TI regarding third-party products or services does not constitute a license to use such products or services or a warranty or endorsement thereof. Use of such information may require a license from a third party under the patents or other intellectual property of the third party, or a license from TI under the patents or other intellectual property of TI.

Reproduction of significant portions of TI information in TI data books or data sheets is permissible only if reproduction is without alteration and is accompanied by all associated warranties, conditions, limitations, and notices. TI is not responsible or liable for such altered documentation. Information of third parties may be subject to additional restrictions.

Resale of TI components or services with statements different from or beyond the parameters stated by TI for that component or service voids all express and any implied warranties for the associated TI component or service and is an unfair and deceptive business practice. TI is not responsible or liable for any such statements.

Buyer acknowledges and agrees that it is solely responsible for compliance with all legal, regulatory and safety-related requirements concerning its products, and any use of TI components in its applications, notwithstanding any applications-related information or support that may be provided by TI. Buyer represents and agrees that it has all the necessary expertise to create and implement safeguards which anticipate dangerous consequences of failures, monitor failures and their consequences, lessen the likelihood of failures that might cause harm and take appropriate remedial actions. Buyer will fully indemnify TI and its representatives against any damages arising out of the use of any TI components in safety-critical applications.

In some cases, TI components may be promoted specifically to facilitate safety-related applications. With such components, TI's goal is to help enable customers to design and create their own end-product solutions that meet applicable functional safety standards and requirements. Nonetheless, such components are subject to these terms.

No TI components are authorized for use in FDA Class III (or similar life-critical medical equipment) unless authorized officers of the parties have executed a special agreement specifically governing such use.

Only those TI components which TI has specifically designated as military grade or "enhanced plastic" are designed and intended for use in military/aerospace applications or environments. Buyer acknowledges and agrees that any military or aerospace use of TI components which have **not** been so designated is solely at the Buyer's risk, and that Buyer is solely responsible for compliance with all legal and regulatory requirements in connection with such use.

TI has specifically designated certain components as meeting ISO/TS16949 requirements, mainly for automotive use. In any case of use of non-designated products, TI will not be responsible for any failure to meet ISO/TS16949.

### Products

Audio	<a href="http://www.ti.com/audio">www.ti.com/audio</a>
Amplifiers	<a href="http://amplifier.ti.com">amplifier.ti.com</a>
Data Converters	<a href="http://dataconverter.ti.com">dataconverter.ti.com</a>
DLP® Products	<a href="http://www.dlp.com">www.dlp.com</a>
DSP	<a href="http://dsp.ti.com">dsp.ti.com</a>
Clocks and Timers	<a href="http://www.ti.com/clocks">www.ti.com/clocks</a>
Interface	<a href="http://interface.ti.com">interface.ti.com</a>
Logic	<a href="http://logic.ti.com">logic.ti.com</a>
Power Mgmt	<a href="http://power.ti.com">power.ti.com</a>
Microcontrollers	<a href="http://microcontroller.ti.com">microcontroller.ti.com</a>
RFID	<a href="http://www.ti-rfid.com">www.ti-rfid.com</a>
OMAP Applications Processors	<a href="http://www.ti.com/omap">www.ti.com/omap</a>
Wireless Connectivity	<a href="http://www.ti.com/wirelessconnectivity">www.ti.com/wirelessconnectivity</a>

### Applications

Automotive and Transportation	<a href="http://www.ti.com/automotive">www.ti.com/automotive</a>
Communications and Telecom	<a href="http://www.ti.com/communications">www.ti.com/communications</a>
Computers and Peripherals	<a href="http://www.ti.com/computers">www.ti.com/computers</a>
Consumer Electronics	<a href="http://www.ti.com/consumer-apps">www.ti.com/consumer-apps</a>
Energy and Lighting	<a href="http://www.ti.com/energy">www.ti.com/energy</a>
Industrial	<a href="http://www.ti.com/industrial">www.ti.com/industrial</a>
Medical	<a href="http://www.ti.com/medical">www.ti.com/medical</a>
Security	<a href="http://www.ti.com/security">www.ti.com/security</a>
Space, Avionics and Defense	<a href="http://www.ti.com/space-avionics-defense">www.ti.com/space-avionics-defense</a>
Video and Imaging	<a href="http://www.ti.com/video">www.ti.com/video</a>

### TI E2E Community

[e2e.ti.com](http://e2e.ti.com)

Mailing Address: Texas Instruments, Post Office Box 655303, Dallas, Texas 75265  
Copyright © 2014, Texas Instruments Incorporated