

LMC6042 CMOS Dual Micropower Operational Amplifier

Check for Samples: [LMC6042](#)

FEATURES

- **Low Supply Current:** 10 μ A/Amp (typ)
- **Operates from 4.5V to 15V Single Supply**
- **Ultra Low Input Current:** 2 fA (typ)
- **Rail-to-Rail Output Swing**
- **Input Common-Mode Range Includes Ground**

APPLICATIONS

- **Battery Monitoring and Power Conditioning**
- **Photodiode and Infrared Detector Preamplifier**
- **Silicon Based Transducer Systems**
- **Hand-Held Analytic Instruments**
- **pH Probe Buffer Amplifier**
- **Fire and Smoke Detection Systems**
- **Charge Amplifier for Piezoelectric Transducers**

DESCRIPTION

Ultra-low power consumption and low input-leakage current are the hallmarks of the LMC6042. Providing input currents of only 2 fA typical, the LMC6042 can operate from a single supply, has output swing extending to each supply rail, and an input voltage range that includes ground.

The LMC6042 is ideal for use in systems requiring ultra-low power consumption. In addition, the insensitivity to latch-up, high output drive, and output swing to ground without requiring external pull-down resistors make it ideal for single-supply battery-powered systems.

Other applications for the LMC6042 include bar code reader amplifiers, magnetic and electric field detectors, and hand-held electrometers.

This device is built with TI's advanced Double-Poly Silicon-Gate CMOS process.

See the LMC6041 for a single, and the LMC6044 for a quad amplifier with these features.

Connection Diagram

Figure 1. 8-Pin PDIP/SOIC

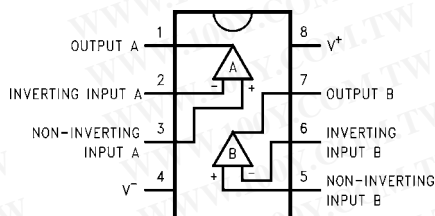
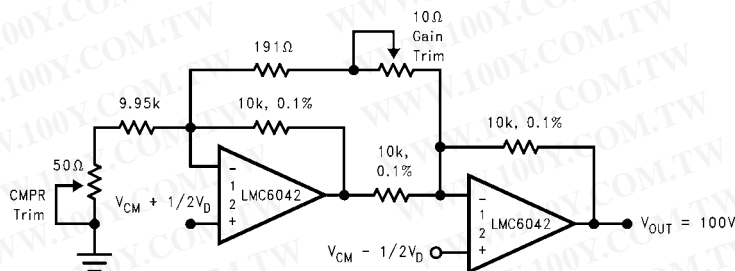

Figure 2. Low-Power Two-Op-Amp Instrumental Amplifier



Please be aware that an important notice concerning availability, standard warranty, and use in critical applications of Texas Instruments semiconductor products and disclaimers thereto appears at the end of this data sheet.

All trademarks are the property of their respective owners.



This integrated circuit can be damaged by ESD. Texas Instruments recommends that all integrated circuits be handled with appropriate precautions. Failure to observe proper handling and installation procedures can cause damage.

ESD damage can range from subtle performance degradation to complete device failure. Precision integrated circuits may be more susceptible to damage because very small parametric changes could cause the device not to meet its published specifications.

Absolute Maximum Ratings ⁽¹⁾⁽²⁾

Differential Input Voltage	±Supply Voltage
Supply Voltage ($V^+ - V^-$)	16V
Output Short Circuit to V^+	See ⁽³⁾
Output Short Circuit to V^-	See ⁽⁴⁾
Lead Temperature (Soldering, 10 seconds)	260°C
Current at Input Pin	±5 mA
Current at Output Pin	±18 mA
Current at Power Supply Pin	35 mA
Power Dissipation	See ⁽⁵⁾
Storage Temperature Range	-65°C to +150°C
Junction Temperature ⁽⁵⁾	110°C
ESD Tolerance ⁽⁶⁾	500V
Voltage at Input/Output Pin	$(V^+) + 0.3V, (V^-) - 0.3V$

- (1) Absolute Maximum Ratings indicate limits beyond which damage to the device may occur. Operating Conditions indicate conditions for which the device is intended to be functional, but do not ensure specific performance limits. For ensured specifications and test conditions, see the Electrical Characteristics. The ensured specifications apply only for the test conditions listed.
- (2) If Military/Aerospace specified devices are required, please contact the TI Sales Office/Distributors for availability and specifications.
- (3) Do not connect output to V^+ when V^+ is greater than 13V or reliability may be adversely affected.
- (4) Applies to both single-supply operation. Continuous short circuit operation at elevated ambient temperature can result in exceeding the maximum allowed junction temperature of 110°C. Output currents in excess of ±30 mA over long term may adversely affect reliability.
- (5) The maximum power dissipation is a function of $T_{J(\text{Max})}$, θ_{JA} , and T_A . The maximum allowable power dissipation at any ambient temperature is $P_D = (T_{J(\text{Max})} - T_A)/\theta_{JA}$.
- (6) Human body model, 1.5 kΩ in series with 100 pF.

Operating Ratings

Temperature Range	LMC6042AI, LMC6042I	-40°C ≤ T_J ≤ +85°C
Supply Voltage		4.5V ≤ V^+ ≤ 15.5V
Power Dissipation		See ⁽¹⁾
Thermal Resistance (θ_{JA}), ⁽²⁾	8-Pin PDIP	101°C/W
	8-Pin SOIC	165°C/W
	8-Pin CDIP	115°C/W

- (1) For operating at elevated temperatures the device must be derated based on the thermal resistance θ_{JA} with $P_D = (T_J - T_A)/\theta_{JA}$.
- (2) All numbers apply for packages soldered directly into a PC board.

Electrical Characteristics

Unless otherwise specified, all limits ensured for $T_A = T_J = 25^\circ\text{C}$. **Boldface** limits apply at the temperature extremes. $V^+ = 5V$, $V^- = 0V$, $V_{CM} = 1.5V$, $V_O = V^+/2$ and $R_L > 1M$ unless otherwise specified.

Symbol	Parameter	Conditions	Typical ⁽¹⁾	LMC6042AI	LMC6042I	Units (Limit)
				Limit ⁽²⁾	Limit ⁽²⁾	
V_{OS}	Input Offset Voltage		1	3	6	mV
				3.3	6.3	Max
TCV_{OS}	Input Offset Voltage Average Drift		1.3			μV/°C
I_B	Input Bias Current		0.002	4	4	pA (Max)
I_{OS}	Input Offset Current		0.001	2	2	pA (Max)
R_{IN}	Input Resistance		>10			TeraΩ

- (1) Typical values represent the most likely parametric norm.
- (2) All limits are specified at room temperature (standard type face) or at operating temperature extremes (bold face type).

Electrical Characteristics (continued)

Unless otherwise specified, all limits ensured for $T_A = T_J = 25^\circ\text{C}$. **Boldface** limits apply at the temperature extremes. $V^+ = 5\text{V}$, $V^- = 0\text{V}$, $V_{\text{CM}} = 1.5\text{V}$, $V_O = V^+/2$ and $R_L > 1\text{M}$ unless otherwise specified.

Symbol	Parameter	Conditions	Typical ⁽¹⁾	LMC6042AI	LMC6042I	Units (Limit)		
				Limit ⁽²⁾	Limit ⁽²⁾			
CMRR	Common Mode Rejection Ratio	$0\text{V} \leq V_{\text{CM}} \leq 12.0\text{V}$ $V^+ = 15\text{V}$	75	68	62	dB		
				66	60	Min		
+PSRR	Positive Power Supply Rejection Ratio	$5\text{V} \leq V^+ \leq 15\text{V}$ $V_O = 2.5\text{V}$	75	68 66	62 60	dB Min		
-PSRR	Negative Power Supply Rejection Ratio	$0\text{V} \leq V^- \leq -10\text{V}$ $V_O = 2.5\text{V}$	94	84 83	74 73	dB Min		
CMR	Input Common-Mode Voltage Range	$V^+ = 5\text{V}$ and 15V For $\text{CMRR} \geq 50\text{ dB}$	-0.4	-0.1	-0.1	V		
				0	0	Max		
				$V^+ - 1.9\text{V}$	$V^+ - 2.3\text{V}$ $V^+ - 2.5\text{V}$	$V^+ - 2.3\text{V}$ $V^+ - 2.4\text{V}$	V Min	
A_V	Large Signal Voltage Gain	$R_L = 100\text{ k}\Omega$ ⁽³⁾	Sourcing	1000	400	300	V/mV	
					300	200	Min	
			Sinking	500	180	90	V/mV	
				120	70	Min		
		$R_L = 25\text{ k}\Omega$ ⁽³⁾	Sourcing	1000	200	100	V/mV	
				160	80	Min		
			Sinking	250	100	50	V/mV	
				60	40	Min		
V_O	Output Swing	$V^+ = 5\text{V}$ $R_L = 100\text{ k}\Omega$ to $V^+/2$	4.987	4.970	4.940	V		
				4.950	4.910	Min		
				0.004	0.030	0.060	V	
				0.050	0.090	Max		
				$V^+ = 5\text{V}$ $R_L = 25\text{ k}\Omega$ to $V^+/2$	4.980	4.920	4.870	V
					4.870	4.820	Min	
		$V^+ = 15\text{V}$ $R_L = 100\text{ k}\Omega$ to $V^+/2$	14.970	14.920	14.880	V		
				14.880	14.820	Min		
				0.007	0.030	0.060	V	
				0.050	0.090	Max		
				$V^+ = 15\text{V}$ $R_L = 25\text{ k}\Omega$ to $V^+/2$	14.950	14.900	14.850	V
					14.850	14.800	Min	
I_{SC}	Output Current $V^+ = 5\text{V}$	Sourcing, $V_O = 0\text{V}$	22	16	13	mA		
				10	8	Min		
		Sinking, $V_O = 5\text{V}$	21	16	13	mA		
				8	8	Min		
I_{SC}	Output Current $V^+ = 15\text{V}$	Sourcing, $V_O = 0\text{V}$	40	15	15	mA		
				10	10	Min		
		Sinking, $V_O = 13\text{V}$ ⁽⁴⁾	39	24	21	mA		
				8	8	Min		

(3) $V^+ = 15\text{V}$, $V_{\text{CM}} = 7.5\text{V}$ and R_L connected to 7.5V . For Sourcing tests, $7.5\text{V} \leq V_O \leq 11.5\text{V}$. For Sinking tests, $2.5\text{V} \leq V_O \leq 7.5\text{V}$.

(4) Do not connect output to V^+ when V^+ is greater than 13V or reliability may be adversely affected.

Electrical Characteristics (continued)

Unless otherwise specified, all limits ensured for $T_A = T_J = 25^\circ\text{C}$. **Boldface** limits apply at the temperature extremes. $V^+ = 5\text{V}$, $V^- = 0\text{V}$, $V_{\text{CM}} = 1.5\text{V}$, $V_O = V^+/2$ and $R_L > 1\text{M}$ unless otherwise specified.

Symbol	Parameter	Conditions	Typical ⁽¹⁾	LMC6042AI	LMC6042I	Units (Limit)
				Limit ⁽²⁾	Limit ⁽²⁾	
I_S	Supply Current	Both Amplifiers $V_O = 1.5\text{V}$	20	34	45	μA
				39	50	Max
		Both Amplifiers $V^+ = 15\text{V}$	26	44	56	μA
				51	65	Max

AC Electrical Characteristics

Unless otherwise specified, all limits ensured for $T_A = T_J = 25^\circ\text{C}$. **Boldface** limits apply at the temperature extremes. $V^+ = 5\text{V}$, $V^- = 0\text{V}$, $V_{\text{CM}} = 1.5\text{V}$, $V_O = V^+/2$ and $R_L > 1\text{M}$ unless otherwise specified.

Symbol	Parameter	Conditions	Typ ⁽¹⁾	LMC6042AI	LMC6042I	Units (Limit)
				Limit ⁽²⁾	Limit ⁽²⁾	
SR	Slew Rate	See ⁽³⁾	0.02	0.015	0.010	$\text{V}/\mu\text{s}$
				0.010	0.007	Min
GBW	Gain-Bandwidth Product		100			kHz
ϕ_m	Phase Margin		60			Deg
	Amp-to-Amp Isolation	See ⁽⁴⁾	115			dB
e_n	Input-Referred Voltage Noise	$f = 1\text{ kHz}$	83			$\text{nV}/\sqrt{\text{Hz}}$
i_n	Input-Referred Current Noise	$f = 1\text{ kHz}$	0.0002			$\text{pA}/\sqrt{\text{Hz}}$
T.H.D.	Total Harmonic Distortion	$f = 1\text{ kHz}$, $A_V = -5$ $R_L = 100\text{ k}\Omega$, $V_O = 2\text{ V}_{\text{PP}}$ $\pm 5\text{V}$ Supply	0.01			%

(1) Typical values represent the most likely parametric norm.

(2) All limits are ensured at room temperature (standard type face) or at operating temperature extremes (bold face type).

(3) $V^+ = 15\text{V}$. Connected as Voltage Follower with 10V step input. Number specified is the slower of the positive and negative slew rates.

(4) Input referred $V^+ = 15\text{V}$ and $R_L = 100\text{ k}\Omega$ connected to $V^+/2$. Each amp excited in turn with 100 Hz to produce $V_O = 12\text{ V}_{\text{PP}}$.

Typical Performance Characteristics

$V_S = \pm 7.5V$, $T_A = 25^\circ C$ unless otherwise specified

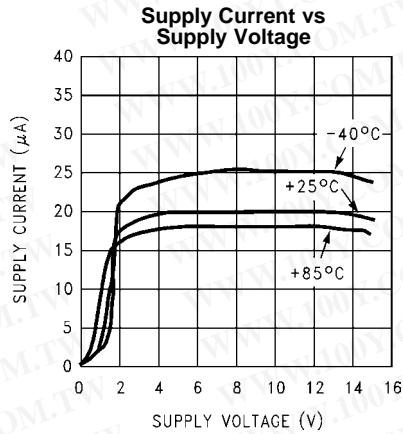

Figure 3.

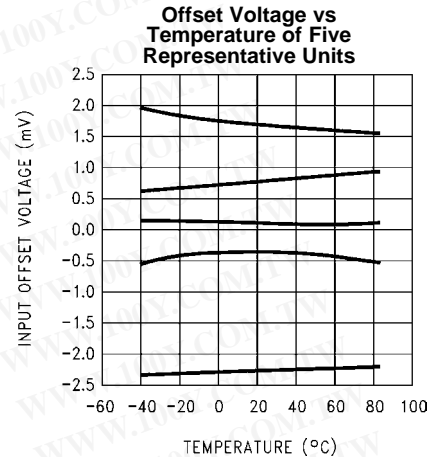

Figure 4.

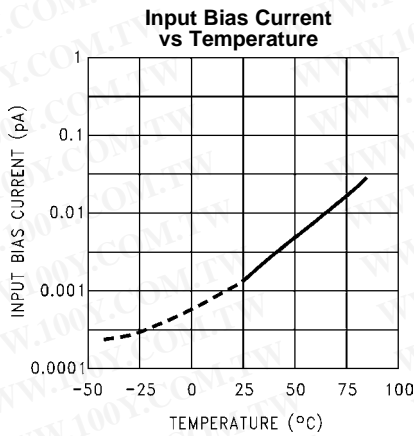

Figure 5.

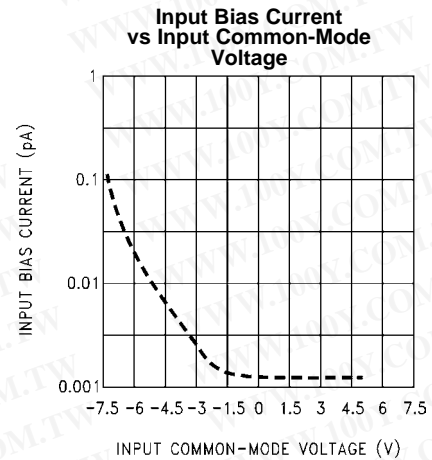

Figure 6.

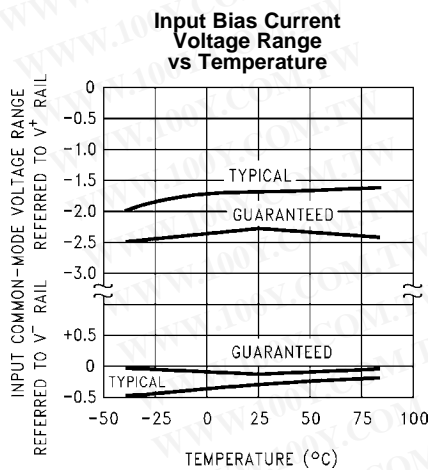

Figure 7.

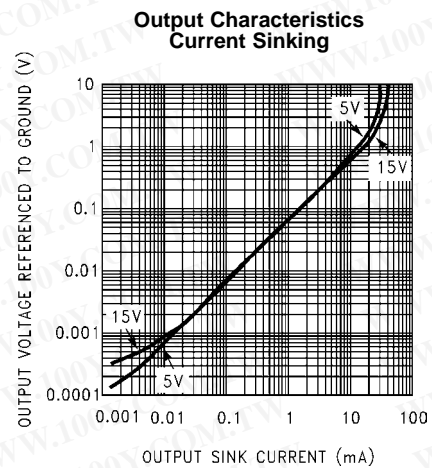

Figure 8.

Typical Performance Characteristics (continued)

$V_S = \pm 7.5V$, $T_A = 25^\circ C$ unless otherwise specified

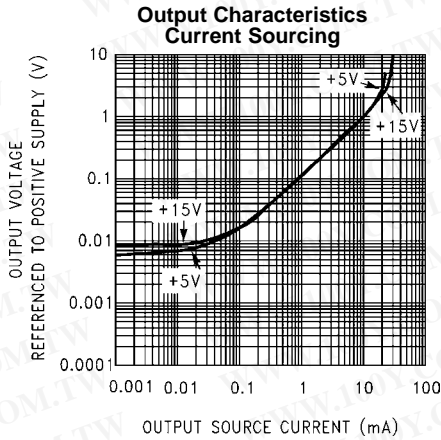

Figure 9.

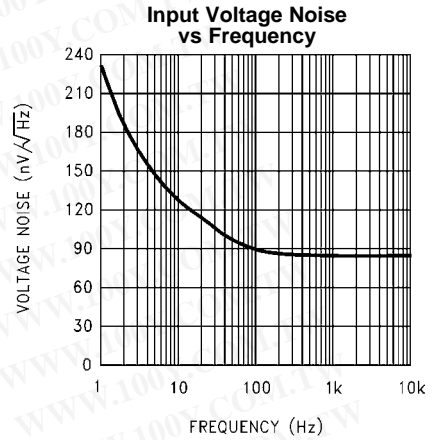

Figure 10.

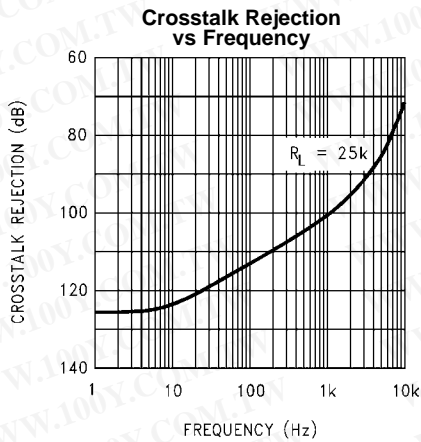

Figure 11.

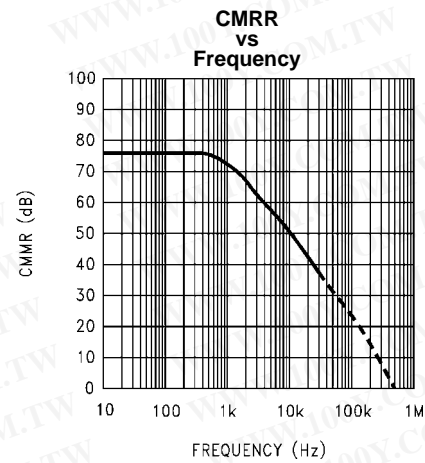

Figure 12.

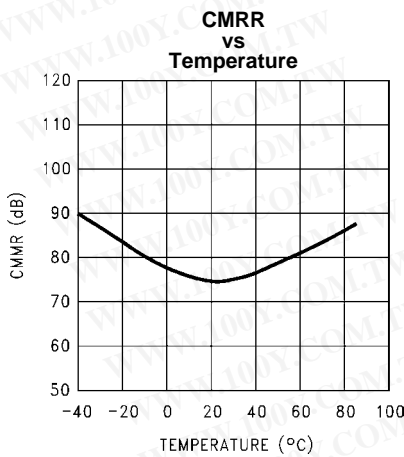

Figure 13.

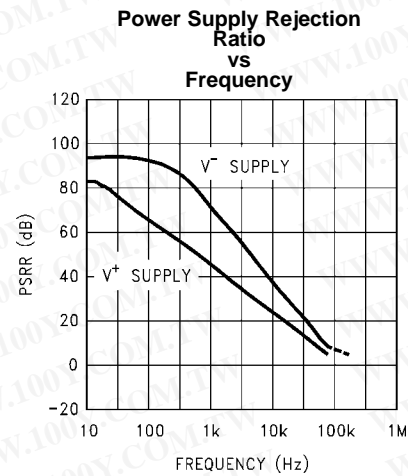

Figure 14.

Typical Performance Characteristics (continued)

$V_S = \pm 7.5V$, $T_A = 25^\circ C$ unless otherwise specified

Open-Loop Voltage Gain vs Temperature

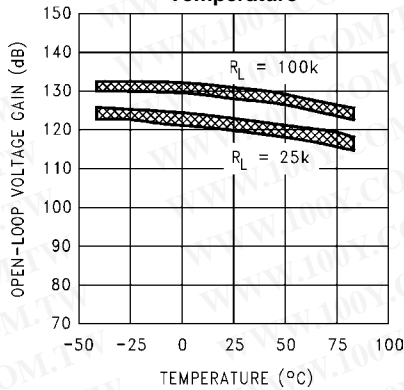

Figure 15.

Open-Loop Frequency Response

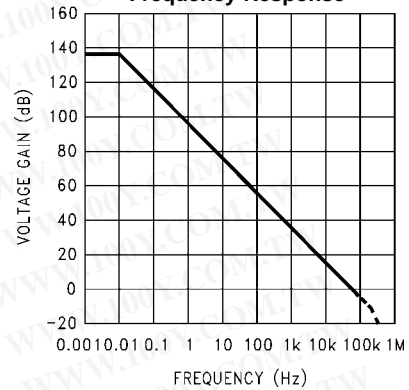

Figure 16.

Gain and Phase Responses vs Load Capacitance

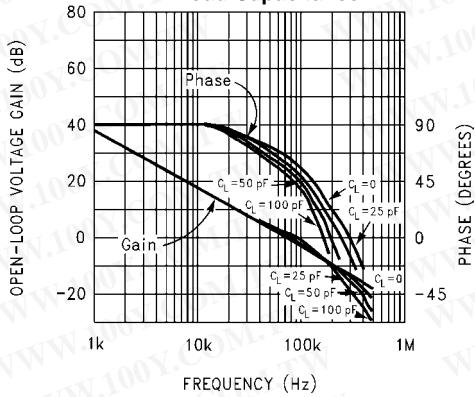

Figure 17.

Gain and Phase Response vs Temperature

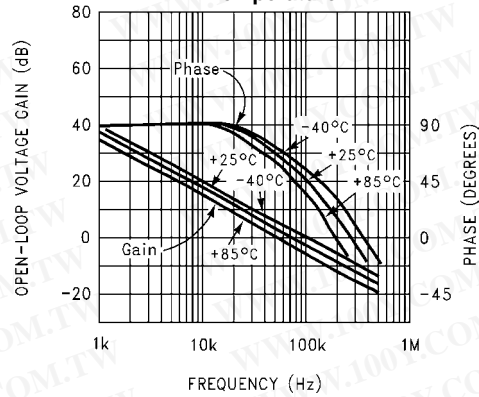

Figure 18.

Gain Error (V_{OS} vs V_{OUT})

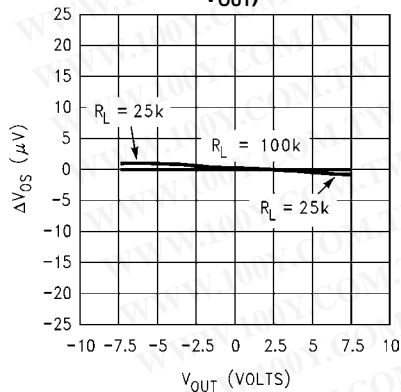

Figure 19.

Common-Mode Error vs Common-Mode Voltage of 3 Representative Units

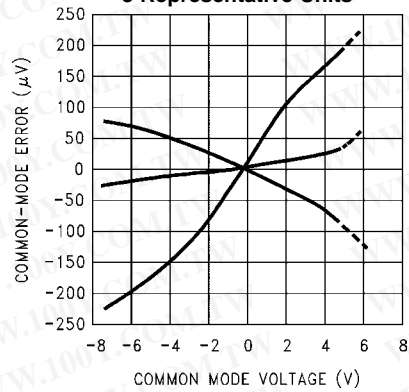

Figure 20.

Typical Performance Characteristics (continued)

$V_S = \pm 7.5V$, $T_A = 25^\circ C$ unless otherwise specified

Non-Inverting Slew Rate vs Temperature

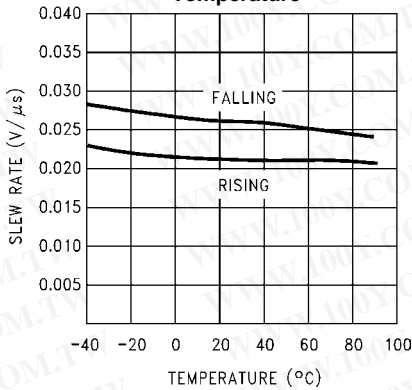

Figure 21.

Inverting Slew Rate vs Temperature

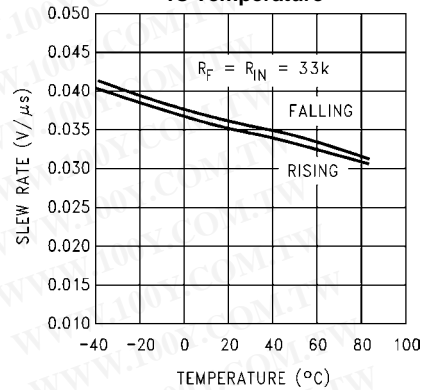

Figure 22.

Non-Inverting Large Signal Pulse Response ($A_V = +1$)

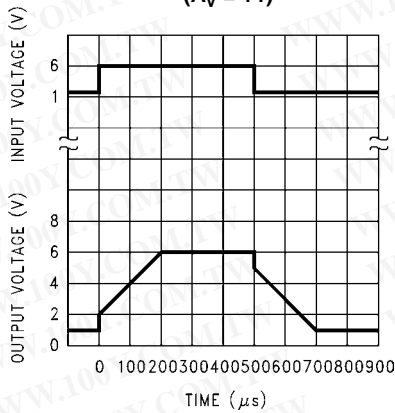

Figure 23.

Non-Inverting Small Signal Pulse Response

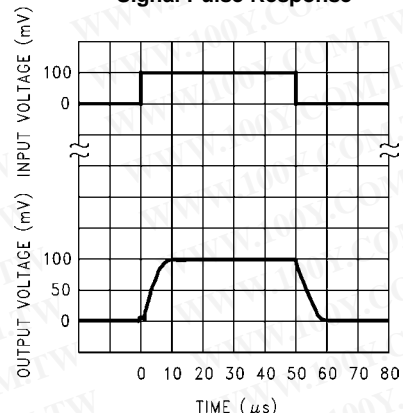

Figure 24.

Inverting Large-Signal Pulse Response

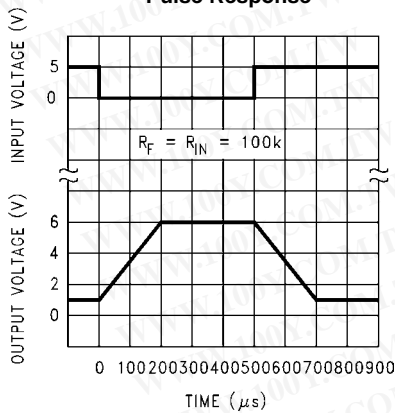

Figure 25.

Inverting Small Signal Pulse Response

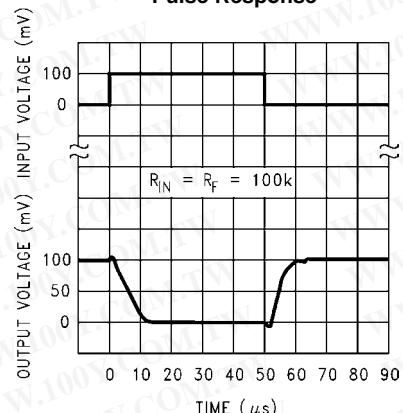

Figure 26.

Typical Performance Characteristics (continued)

$V_S = \pm 7.5V$, $T_A = 25^\circ C$ unless otherwise specified

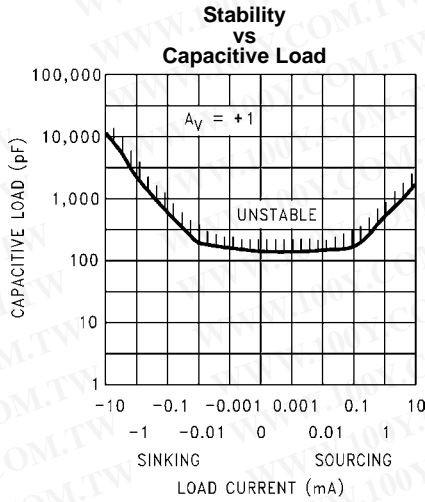

Figure 27.

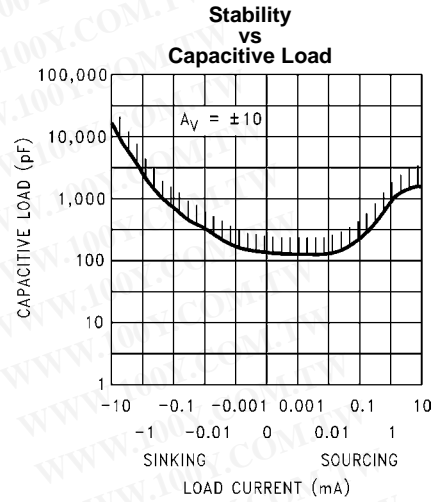

Figure 28.

APPLICATIONS HINTS

AMPLIFIER TOPOLOGY

The LMC6042 incorporates a novel op-amp design topology that enables it to maintain rail-to-rail output swing even when driving a large load. Instead of relying on a push-pull unity gain output buffer stage, the output stage is taken directly from the internal integrator, which provides both low output impedance and large gain. Special feed-forward compensation design techniques are incorporated to maintain stability over a wider range of operating conditions than traditional micropower op-amps. These features make the LMC6042 both easier to design with, and provide higher speed than products typically found in this ultra-low power class.

COMPENSATING FOR INPUT CAPACITANCE

It is quite common to use large values of feedback resistance with amplifiers with ultra-low input current, like the LMC6042.

Although the LMC6042 is highly stable over a wide range of operating conditions, certain precautions must be met to achieve the desired pulse response when a large feedback resistor is used. Large feedback resistors and even small values of input capacitance, due to transducers, photodiodes, and circuit board parasitics, reduce phase margins.

When high input impedances are demanded, guarding of the LMC6042 is suggested. Guarding input lines will not only reduce leakage, but lowers stray input capacitance as well. (See [Printed-Circuit-Board Layout for High Impedance Work](#)).

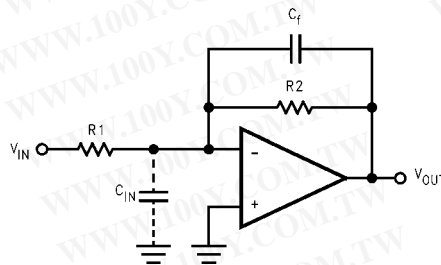

Figure 29. Cancelling the Effect of Input Capacitance

The effect of input capacitance can be compensated for by adding a capacitor. Place a capacitor, C_f , around the feedback resistor (as in [Figure 29](#)) such that:

$$\frac{1}{2\pi R_1 C_{IN}} \geq \frac{1}{2\pi R_2 C_f} \quad (1)$$

or

$$R_1 C_{IN} \leq R_2 C_f \quad (2)$$

Since it is often difficult to know the exact value of C_{IN} , C_f can be experimentally adjusted so that the desired pulse response is achieved. Refer to the LMC660 and the LMC662 for a more detailed discussion on compensating for input capacitance.

CAPACITIVE LOAD TOLERANCE

Direct capacitive loading will reduce the phase margin of many op-amps. A pole in the feedback loop is created by the combination of the op-amp's output impedance and the capacitive load. This pole induces phase lag at the unity-gain crossover frequency of the amplifier resulting in either an oscillatory or underdamped pulse response. With a few external components, op amps can easily indirectly drive capacitive loads, as shown in [Figure 30](#).

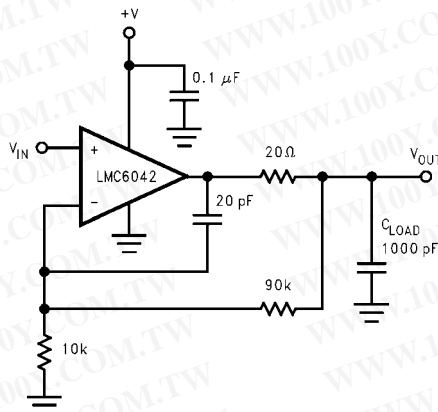

Figure 30. LMC6042 Noninverting Gain of 10 Amplifier, Compensated to Handle Capacitive Loads

In the circuit of [Figure 30](#), R1 and C1 serve to counteract the loss of phase margin by feeding the high frequency component of the output signal back to the amplifier's inverting input, thereby preserving phase margin in the overall feedback loop.

Capacitive load driving capability is enhanced by using a pull up resistor to V⁺ ([Figure 31](#)). Typically a pull up resistor conducting 10 μA or more will significantly improve capacitive load responses. The value of the pull up resistor must be determined based on the current sinking capability of the amplifier with respect to the desired output swing. Open loop gain of the amplifier can also be affected by the pull up resistor (see [Electrical Characteristics](#)).

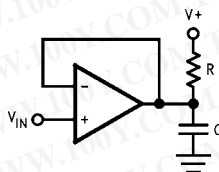

Figure 31. Compensating for Large Capacitive Loads with a Pull Up Resistor

PRINTED-CIRCUIT-BOARD LAYOUT FOR HIGH-IMPEDANCE WORK

It is generally recognized that any circuit which must operate with less than 1000 pA of leakage current requires special layout of the PC board. When one wishes to take advantage of the ultra-low bias current of the LMC6042, typically less than 2 fA, it is essential to have an excellent layout. Fortunately, the techniques of obtaining low leakages are quite simple. First, the user must not ignore the surface leakage of the PC board, even though it may sometimes appear acceptably low, because under conditions of high humidity or dust or contamination, the surface leakage will be appreciable.

To minimize the effect of any surface leakage, lay out a ring of foil completely surrounding the LMC6042's inputs and the terminals of capacitors, diodes, conductors, resistors, relay terminals etc. connected to the op-amp's inputs, as in [Figure 32](#). To have a significant effect, guard rings should be placed on both the top and bottom of the PC board. This PC foil must then be connected to a voltage which is at the same voltage as the amplifier inputs, since no leakage current can flow between two points at the same potential. For example, a PC board trace-to-pad resistance of $10^{12}\Omega$, which is normally considered a very large resistance, could leak 5 pA if the trace were a 5V bus adjacent to the pad of the input. This would cause a 100 times degradation from the LMC6042's actual performance. However, if a guard ring is held within 5 mV of the inputs, then even a resistance of $10^{11}\Omega$ would cause only 0.05 pA of leakage current. See [Figure 36](#) for typical connections of guard rings for standard op-amp configurations.

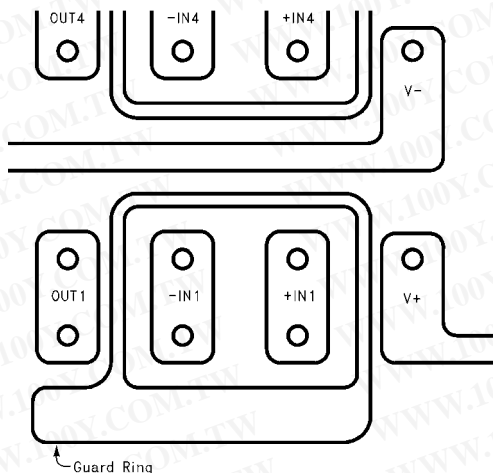

Figure 32. Example of Guard Ring in P.C. Board Layout

Figure 33. Inverting Amplifier

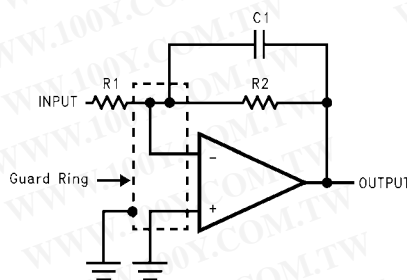

Figure 34. Non-Inverting Amplifier

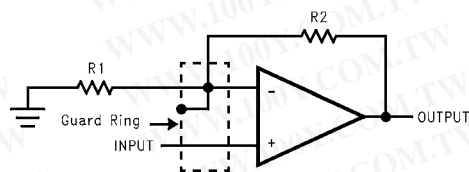

Figure 35. Follower

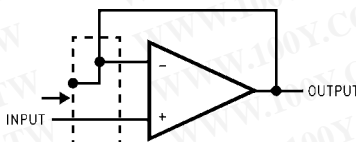
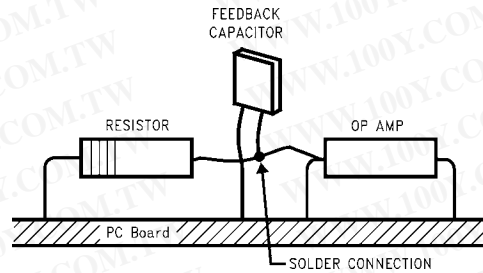

Figure 36. Typical Connections of Guard Rings

The designer should be aware that when it is inappropriate to lay out a PC board for the sake of just a few circuits, there is another technique which is even better than a guard ring on a PC board: Don't insert the amplifier's input pin into the board at all, but bend it up in the air and use only air as an insulator. Air is an excellent insulator. In this case you may have to forego some of the advantages of PC board construction, but the advantages are sometimes well worth the effort of using point-to-point up-in-the-air wiring. See [Figure 37](#).



(Input pins are lifted out of PC board and soldered directly to components. All other pins connected to PC board.)

Figure 37. Air Wiring

Typical Single-Supply Applications

$$(V^+ = 5.0 V_{DC})$$

The extremely high input impedance, and low power consumption, of the LMC6042 make it ideal for applications that require battery-powered instrumentation amplifiers. Examples of these types of applications are hand-held pH probes, analytic medical instruments, magnetic field detectors, gas detectors, and silicon based pressure transducers.

The circuit in [Figure 38](#) is recommended for applications where the common-mode input range is relatively low and the differential gain will be in the range of 10 to 1000. This two op-amp instrumentation amplifier features an independent adjustment of the gain and common-mode rejection trim, and a total quiescent supply current of less than 20 μ A. To maintain ultra-high input impedance, it is advisable to use ground rings and consider PC board layout an important part of the overall system design (see [Printed-Circuit-Board Layout for High Impedance Work](#)). Referring to [Figure 38](#), the input voltages are represented as a common-mode input V_{CM} plus a differential input V_D .

Rejection of the common-mode component of the input is accomplished by making the ratio of R_1/R_2 equal to R_3/R_4 . So that where,

$$\frac{R_3}{R_4} = \frac{R_2}{R_1}$$

$$V_{OUT} = \frac{R_4}{R_3} \left(1 + \frac{R_3}{R_4} + \frac{R_2 + R_3}{R_0} \right) V_D \quad (3)$$

A suggested design guideline is to minimize the difference of value between R_1 through R_4 . This will often result in improved resistor tempco, amplifier gain, and CMRR over temperature. If $R_N = R_1 = R_2 = R_3 = R_4$ then the gain equation can be simplified:

$$V_{OUT} = 2 \left(1 + \frac{R_N}{R_0} \right) V_D \quad (4)$$

Due to the “zero-in, zero-out” performance of the LMC6042, and output swing rail-rail, the dynamic range is only limited to the input common-mode range of 0V to $V_S - 2.3V$, worst case at room temperature. This feature of the LMC6042 makes it an ideal choice for low-power instrumentation systems.

A complete instrumentation amplifier designed for a gain of 100 is shown in [Figure 39](#). Provisions have been made for low sensitivity trimming of CMRR and gain.

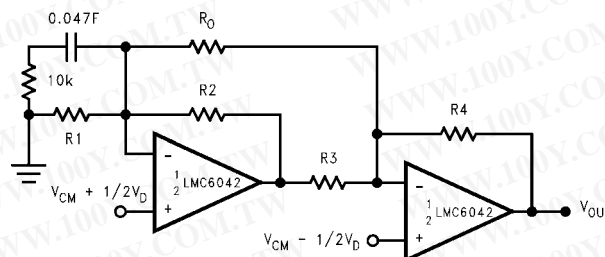

Figure 38. Two Op-Amp Instrumentation Amplifier

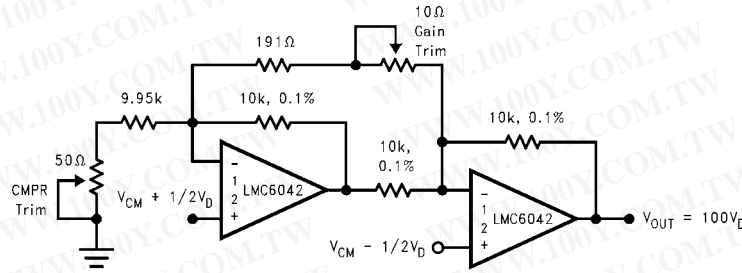

Figure 39. Low-Power Two-Op-Amp Instrumentation Amplifier

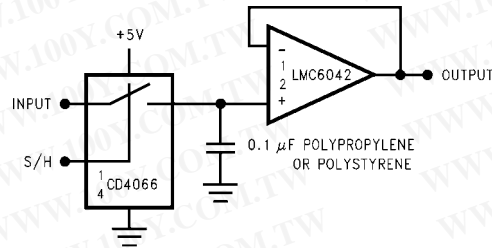

Figure 40. Low-Leakage Sample and Hold

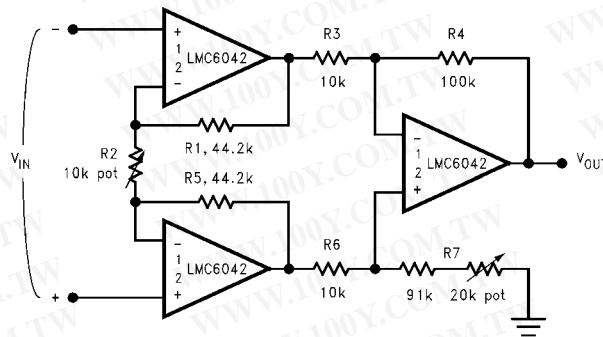

Figure 41. Instrumentation Amplifier

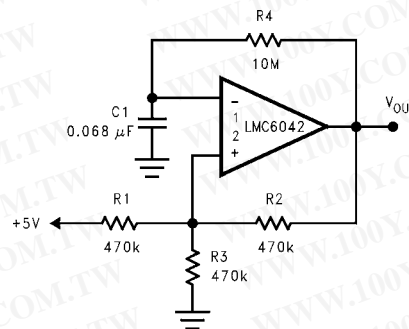

Figure 42. 1 Hz Square Wave Oscillator

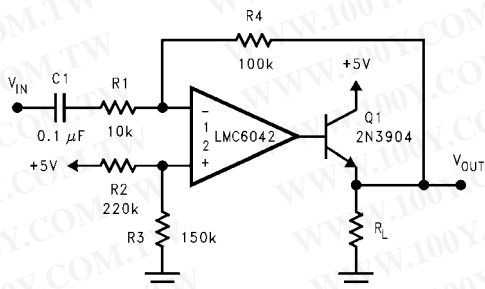

Figure 43. AC Coupled Power Amplifier

REVISION HISTORY

Changes from Revision D (March 2013) to Revision E

Page

- Changed layout of National Data Sheet to TI format 15

PACKAGING INFORMATION

Orderable Device	Status (1)	Package Type	Package Drawing	Pins	Package Qty	Eco Plan (2)	Lead/Ball Finish	MSL Peak Temp (3)	Op Temp (°C)	Top-Side Markings (4)	Samples
LMC6042AIJ	ACTIVE	CDIP	NAB	8	40	TBD	Call TI	Call TI		LMC6042AIJ	Samples
LMC6042AIM	ACTIVE	SOIC	D	8	95	TBD	Call TI	Call TI	-40 to 85	LMC6042AIM	Samples
LMC6042AIM/NOPB	ACTIVE	SOIC	D	8	95	Green (RoHS & no Sb/Br)	CU SN	Level-1-260C-UNLIM	-40 to 85	LMC6042AIM	Samples
LMC6042AIMX	ACTIVE	SOIC	D	8	2500	TBD	Call TI	Call TI	-40 to 85	LMC6042AIM	Samples
LMC6042AIMX/NOPB	ACTIVE	SOIC	D	8	2500	Green (RoHS & no Sb/Br)	CU SN	Level-1-260C-UNLIM	-40 to 85	LMC6042AIM	Samples
LMC6042AIN	ACTIVE	PDIP	P	8	40	TBD	Call TI	Call TI	-40 to 85	LMC6042AIN	Samples
LMC6042AIN/NOPB	ACTIVE	PDIP	P	8	40	Green (RoHS & no Sb/Br)	Call TI	Level-1-NA-UNLIM	-40 to 85	LMC6042AIN	Samples
LMC6042IM	ACTIVE	SOIC	D	8	95	TBD	Call TI	Call TI	-40 to 85	LMC6042IM	Samples
LMC6042IM/NOPB	ACTIVE	SOIC	D	8	95	Green (RoHS & no Sb/Br)	CU SN	Level-1-260C-UNLIM	-40 to 85	LMC6042IM	Samples
LMC6042IMX	ACTIVE	SOIC	D	8	2500	TBD	Call TI	Call TI	-40 to 85	LMC6042IM	Samples
LMC6042IMX/NOPB	ACTIVE	SOIC	D	8	2500	Green (RoHS & no Sb/Br)	CU SN	Level-1-260C-UNLIM	-40 to 85	LMC6042IM	Samples
LMC6042IN	ACTIVE	PDIP	P	8	40	TBD	Call TI	Call TI	-40 to 85	LMC6042IN	Samples
LMC6042IN/NOPB	ACTIVE	PDIP	P	8	40	Green (RoHS & no Sb/Br)	Call TI	Level-1-NA-UNLIM	-40 to 85	LMC6042IN	Samples

(1) The marketing status values are defined as follows:

ACTIVE: Product device recommended for new designs.

LIFEBUY: TI has announced that the device will be discontinued, and a lifetime-buy period is in effect.

NRND: Not recommended for new designs. Device is in production to support existing customers, but TI does not recommend using this part in a new design.

PREVIEW: Device has been announced but is not in production. Samples may or may not be available.

OBSELETE: TI has discontinued the production of the device.

(2) Eco Plan - The planned eco-friendly classification: Pb-Free (RoHS), Pb-Free (RoHS Exempt), or Green (RoHS & no Sb/Br) - please check <http://www.ti.com/productcontent> for the latest availability information and additional product content details.

TBD: The Pb-Free/Green conversion plan has not been defined.

Pb-Free (RoHS): TI's terms "Lead-Free" or "Pb-Free" mean semiconductor products that are compatible with the current RoHS requirements for all 6 substances, including the requirement that lead not exceed 0.1% by weight in homogeneous materials. Where designed to be soldered at high temperatures, TI Pb-Free products are suitable for use in specified lead-free processes.

Pb-Free (RoHS Exempt): This component has a RoHS exemption for either 1) lead-based flip-chip solder bumps used between the die and package, or 2) lead-based die adhesive used between the die and leadframe. The component is otherwise considered Pb-Free (RoHS compatible) as defined above.

Green (RoHS & no Sb/Br): TI defines "Green" to mean Pb-Free (RoHS compatible), and free of Bromine (Br) and Antimony (Sb) based flame retardants (Br or Sb do not exceed 0.1% by weight in homogeneous material)

(3) MSL, Peak Temp. -- The Moisture Sensitivity Level rating according to the JEDEC industry standard classifications, and peak solder temperature.

(4) Multiple Top-Side Markings will be inside parentheses. Only one Top-Side Marking contained in parentheses and separated by a "~" will appear on a device. If a line is indented then it is a continuation of the previous line and the two combined represent the entire Top-Side Marking for that device.

Important Information and Disclaimer: The information provided on this page represents TI's knowledge and belief as of the date that it is provided. TI bases its knowledge and belief on information provided by third parties, and makes no representation or warranty as to the accuracy of such information. Efforts are underway to better integrate information from third parties. TI has taken and continues to take reasonable steps to provide representative and accurate information but may not have conducted destructive testing or chemical analysis on incoming materials and chemicals. TI and TI suppliers consider certain information to be proprietary, and thus CAS numbers and other limited information may not be available for release.

In no event shall TI's liability arising out of such information exceed the total purchase price of the TI part(s) at issue in this document sold by TI to Customer on an annual basis.

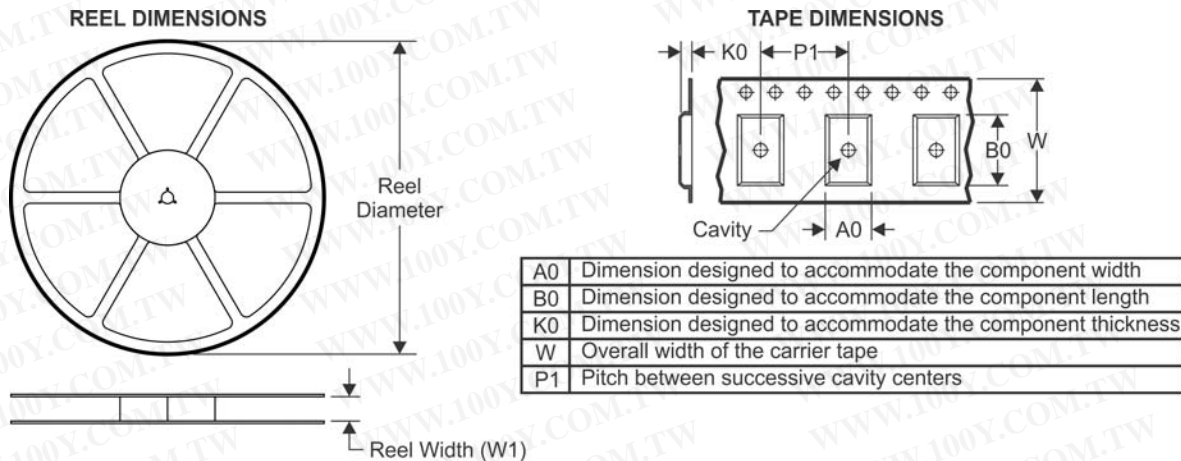
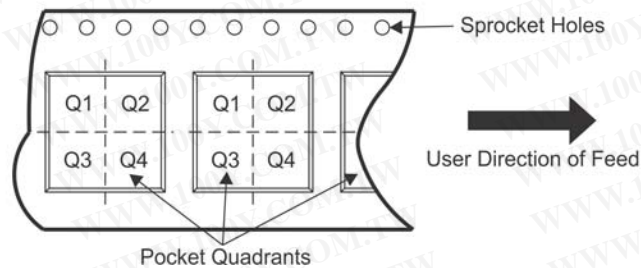
TAPE AND REEL INFORMATION

QUADRANT ASSIGNMENTS FOR PIN 1 ORIENTATION IN TAPE

*All dimensions are nominal

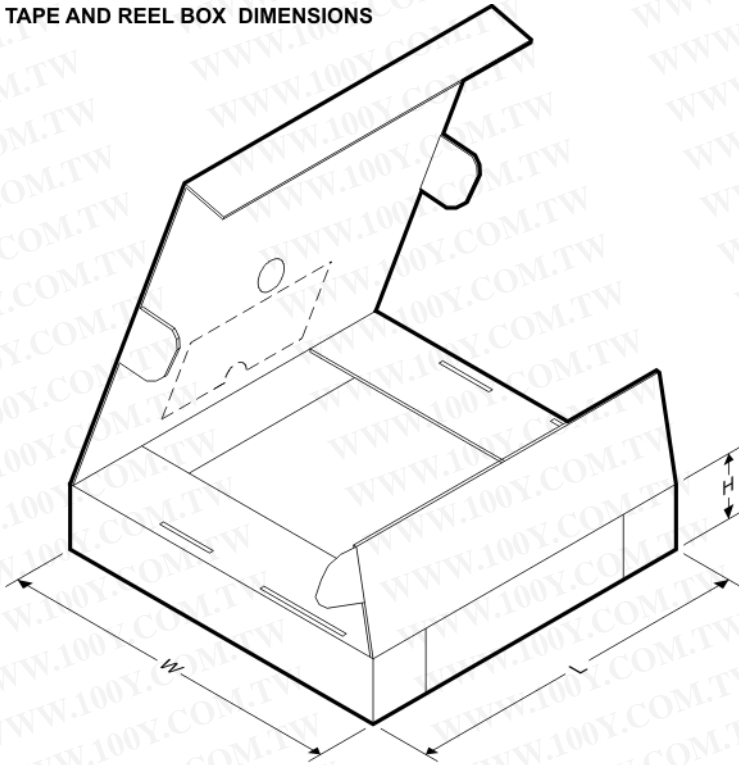
Device	Package Type	Package Drawing	Pins	SPQ	Reel Diameter (mm)	Reel Width W1 (mm)	A0 (mm)	B0 (mm)	K0 (mm)	P1 (mm)	W (mm)	Pin1 Quadrant
LMC6042AIMX	SOIC	D	8	2500	330.0	12.4	6.5	5.4	2.0	8.0	12.0	Q1
LMC6042AIMX/NOPB	SOIC	D	8	2500	330.0	12.4	6.5	5.4	2.0	8.0	12.0	Q1
LMC6042IMX	SOIC	D	8	2500	330.0	12.4	6.5	5.4	2.0	8.0	12.0	Q1
LMC6042IMX/NOPB	SOIC	D	8	2500	330.0	12.4	6.5	5.4	2.0	8.0	12.0	Q1

TAPE AND REEL BOX DIMENSIONS

*All dimensions are nominal

Device	Package Type	Package Drawing	Pins	SPQ	Length (mm)	Width (mm)	Height (mm)
LMC6042AIMX	SOIC	D	8	2500	367.0	367.0	35.0
LMC6042AIMX/NOPB	SOIC	D	8	2500	367.0	367.0	35.0
LMC6042IMX	SOIC	D	8	2500	367.0	367.0	35.0
LMC6042IMX/NOPB	SOIC	D	8	2500	367.0	367.0	35.0

NAB0008A

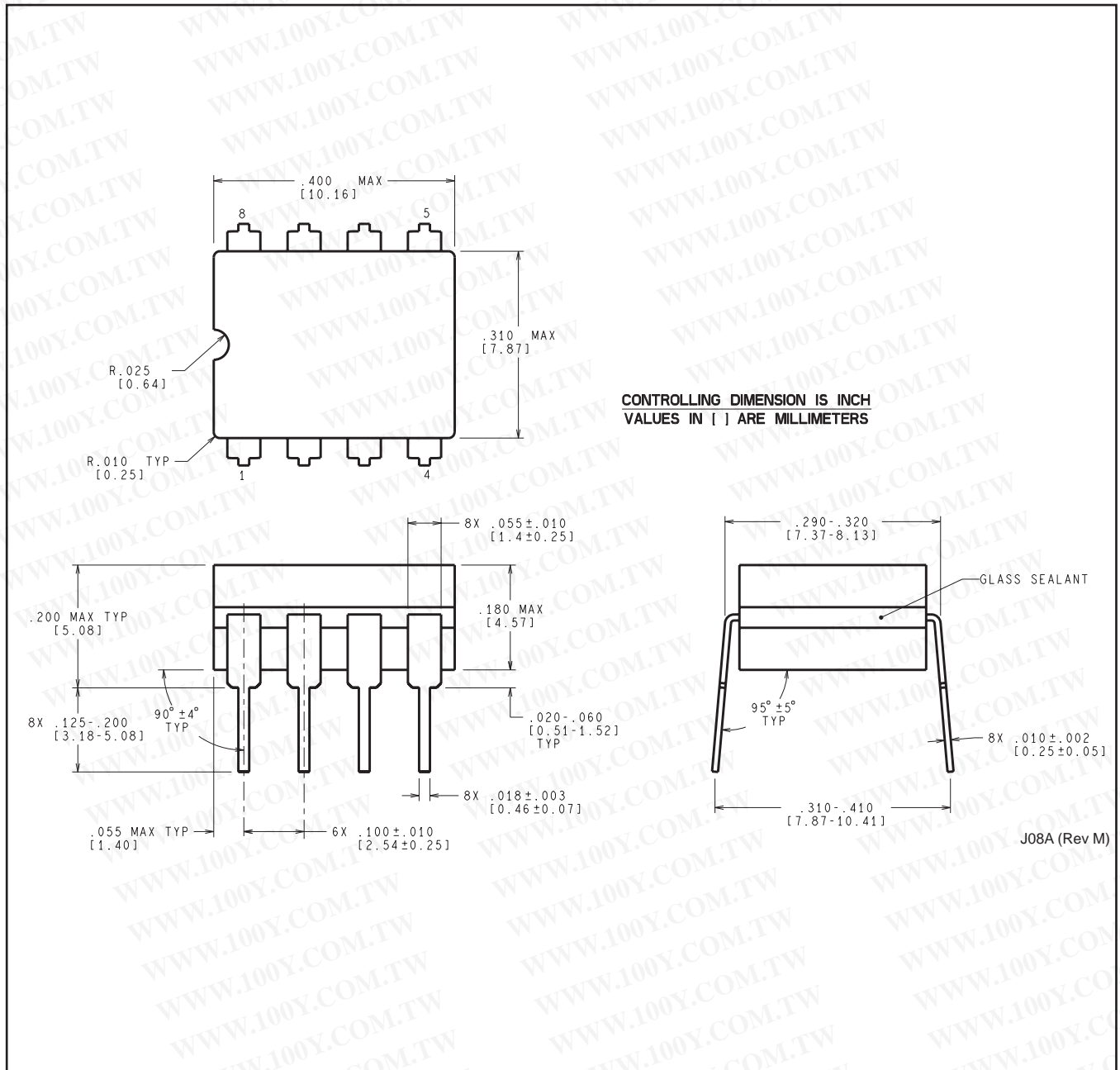

P (R-PDIP-T8)

PLASTIC DUAL-IN-LINE PACKAGE

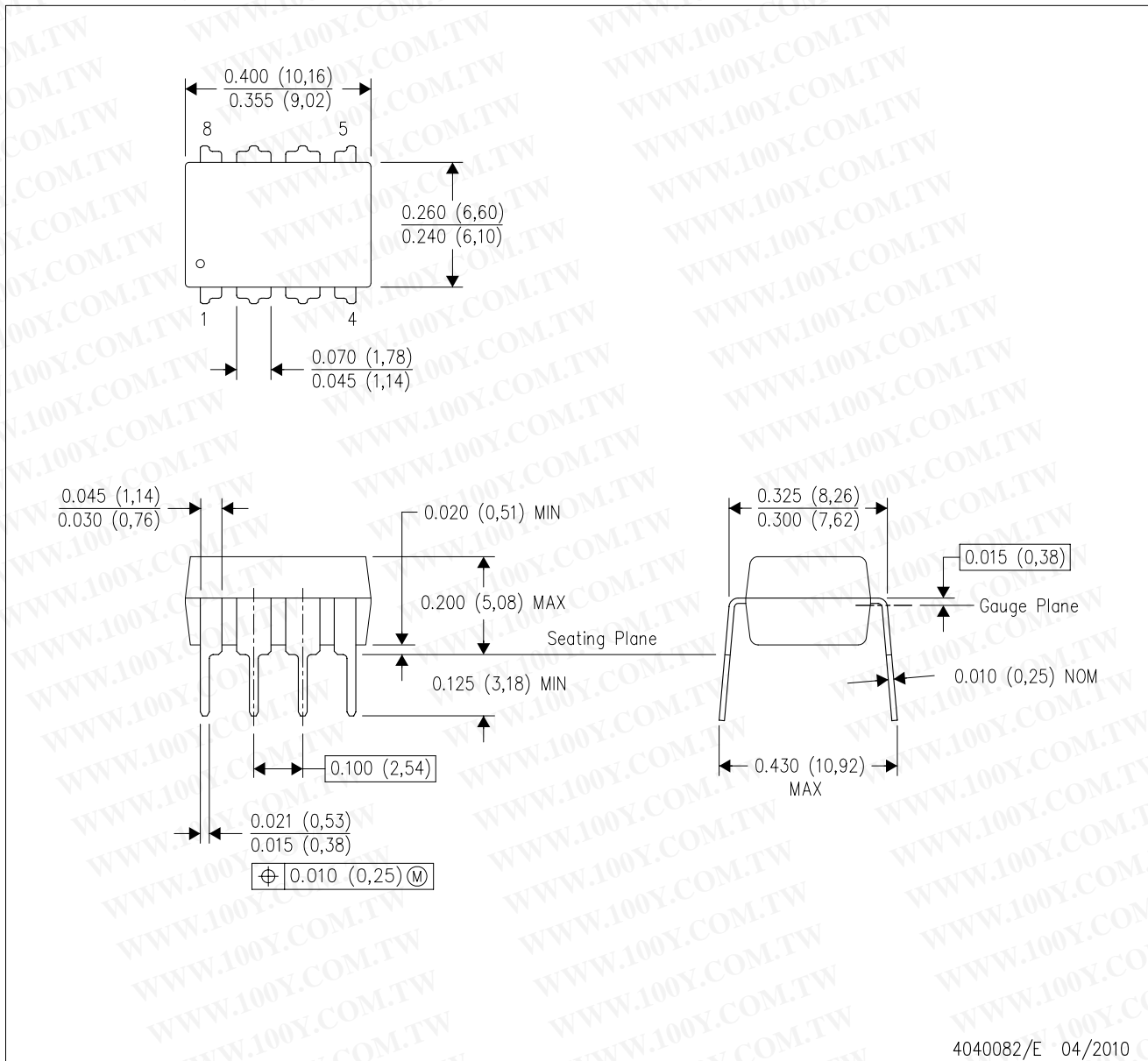

4040082/E 04/2010

- NOTES:
- A. All linear dimensions are in inches (millimeters).
 - B. This drawing is subject to change without notice.
 - C. Falls within JEDEC MS-001 variation BA.

D (R-PDSO-G8)

PLASTIC SMALL OUTLINE

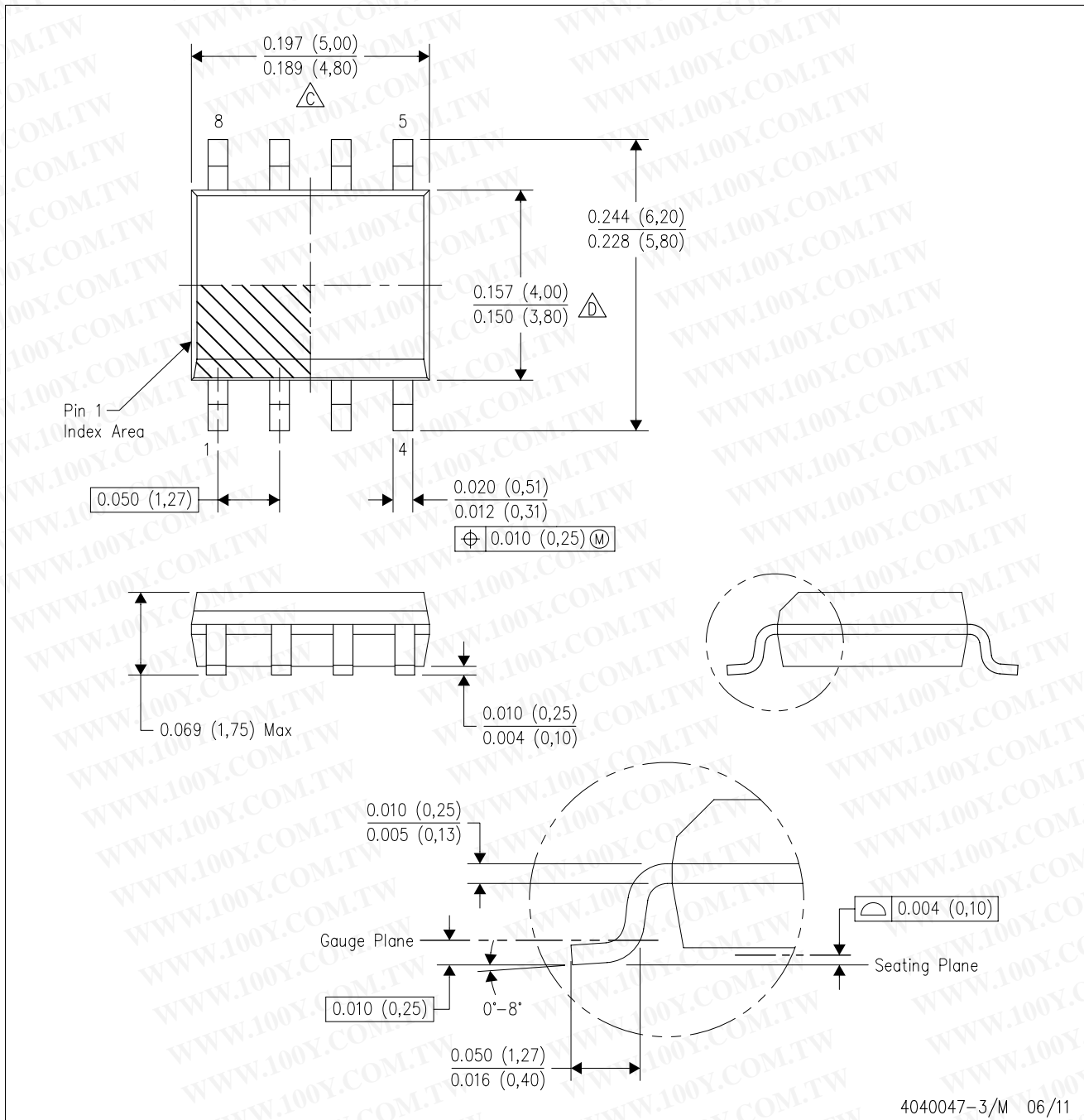

- NOTES:
- A. All linear dimensions are in inches (millimeters).
 - B. This drawing is subject to change without notice.
 - △ Body length does not include mold flash, protrusions, or gate burrs. Mold flash, protrusions, or gate burrs shall not exceed 0.006 (0,15) each side.
 - △ Body width does not include interlead flash. Interlead flash shall not exceed 0.017 (0,43) each side.
 - E. Reference JEDEC MS-012 variation AA.

勝特力材料 886-3-5753170
勝特力电子(上海) 86-21-34970699
勝特力电子(深圳) 86-755-83298787
[Http://www.100y.com.tw](http://www.100y.com.tw)

IMPORTANT NOTICE

Texas Instruments Incorporated and its subsidiaries (TI) reserve the right to make corrections, enhancements, improvements and other changes to its semiconductor products and services per JESD46, latest issue, and to discontinue any product or service per JESD48, latest issue. Buyers should obtain the latest relevant information before placing orders and should verify that such information is current and complete. All semiconductor products (also referred to herein as "components") are sold subject to TI's terms and conditions of sale supplied at the time of order acknowledgment.

TI warrants performance of its components to the specifications applicable at the time of sale, in accordance with the warranty in TI's terms and conditions of sale of semiconductor products. Testing and other quality control techniques are used to the extent TI deems necessary to support this warranty. Except where mandated by applicable law, testing of all parameters of each component is not necessarily performed.

TI assumes no liability for applications assistance or the design of Buyers' products. Buyers are responsible for their products and applications using TI components. To minimize the risks associated with Buyers' products and applications, Buyers should provide adequate design and operating safeguards.

TI does not warrant or represent that any license, either express or implied, is granted under any patent right, copyright, mask work right, or other intellectual property right relating to any combination, machine, or process in which TI components or services are used. Information published by TI regarding third-party products or services does not constitute a license to use such products or services or a warranty or endorsement thereof. Use of such information may require a license from a third party under the patents or other intellectual property of the third party, or a license from TI under the patents or other intellectual property of TI.

Reproduction of significant portions of TI information in TI data books or data sheets is permissible only if reproduction is without alteration and is accompanied by all associated warranties, conditions, limitations, and notices. TI is not responsible or liable for such altered documentation. Information of third parties may be subject to additional restrictions.

Resale of TI components or services with statements different from or beyond the parameters stated by TI for that component or service voids all express and any implied warranties for the associated TI component or service and is an unfair and deceptive business practice. TI is not responsible or liable for any such statements.

Buyer acknowledges and agrees that it is solely responsible for compliance with all legal, regulatory and safety-related requirements concerning its products, and any use of TI components in its applications, notwithstanding any applications-related information or support that may be provided by TI. Buyer represents and agrees that it has all the necessary expertise to create and implement safeguards which anticipate dangerous consequences of failures, monitor failures and their consequences, lessen the likelihood of failures that might cause harm and take appropriate remedial actions. Buyer will fully indemnify TI and its representatives against any damages arising out of the use of any TI components in safety-critical applications.

In some cases, TI components may be promoted specifically to facilitate safety-related applications. With such components, TI's goal is to help enable customers to design and create their own end-product solutions that meet applicable functional safety standards and requirements. Nonetheless, such components are subject to these terms.

No TI components are authorized for use in FDA Class III (or similar life-critical medical equipment) unless authorized officers of the parties have executed a special agreement specifically governing such use.

Only those TI components which TI has specifically designated as military grade or "enhanced plastic" are designed and intended for use in military/aerospace applications or environments. Buyer acknowledges and agrees that any military or aerospace use of TI components which have **not** been so designated is solely at the Buyer's risk, and that Buyer is solely responsible for compliance with all legal and regulatory requirements in connection with such use.

TI has specifically designated certain components as meeting ISO/TS16949 requirements, mainly for automotive use. In any case of use of non-designated products, TI will not be responsible for any failure to meet ISO/TS16949.

Products

Audio	www.ti.com/audio
Amplifiers	amplifier.ti.com
Data Converters	dataconverter.ti.com
DLP® Products	www.dlp.com
DSP	dsp.ti.com
Clocks and Timers	www.ti.com/clocks
Interface	interface.ti.com
Logic	logic.ti.com
Power Mgmt	power.ti.com
Microcontrollers	microcontroller.ti.com
RFID	www.ti-rfid.com
OMAP Applications Processors	www.ti.com/omap
Wireless Connectivity	www.ti.com/wirelessconnectivity

Applications

Automotive and Transportation	www.ti.com/automotive
Communications and Telecom	www.ti.com/communications
Computers and Peripherals	www.ti.com/computers
Consumer Electronics	www.ti.com/consumer-apps
Energy and Lighting	www.ti.com/energy
Industrial	www.ti.com/industrial
Medical	www.ti.com/medical
Security	www.ti.com/security
Space, Avionics and Defense	www.ti.com/space-avionics-defense
Video and Imaging	www.ti.com/video

TI E2E Community

e2e.ti.com

Mailing Address: Texas Instruments, Post Office Box 655303, Dallas, Texas 75265
Copyright © 2013, Texas Instruments Incorporated