

Single and Dual Precision, 17 MHz, Low Noise, CMOS Input Amplifiers

Check for Samples: [LMP7715](#), [LMP7716](#), [LMP7716Q](#)

FEATURES

- Unless Otherwise Noted, Typical Values at $V_S = 5V$.
 - Input Offset Voltage $\pm 150 \mu V$ (Max)
 - Input Bias Current 100 fA
 - Input Voltage Noise $5.8 \text{ nV}/\sqrt{\text{Hz}}$
 - Gain Bandwidth Product 17 MHz
 - Supply Current (LMP7715) 1.15 mA
 - Supply Current (LMP7716/LMP7716Q) 1.30 mA
 - Supply Voltage Range 1.8V to 5.5V
 - THD+N @ $f = 1 \text{ kHz}$ 0.001%
 - Operating Temperature Range -40°C to 125°C
 - Rail-to-rail Output Swing
 - Space Saving SOT-23 Package (LMP7715)
 - 8-Pin VSSOP Package (LMP7716/LMP7716Q)
 - LMP7716Q is AEC-Q100 Grade 1 Qualified and is Manufactured on an Automotive Grade Flow

APPLICATIONS

- Active Filters and Buffers
- Sensor Interface Applications
- Transimpedance Amplifiers
- Automotive

DESCRIPTION

The LMP7715/LMP7716/LMP7716Q are single and dual low noise, low offset, CMOS input, rail-to-rail output precision amplifiers with high gain bandwidth products. The LMP7715/LMP7716/LMP7716Q are part of the LMP™ precision amplifier family and are ideal for a variety of instrumentation applications.

Utilizing a CMOS input stage, the LMP7715/LMP7716/LMP7716Q achieve an input bias current of 100 fA, an input referred voltage noise of $5.8 \text{ nV}/\sqrt{\text{Hz}}$, and an input offset voltage of less than $\pm 150 \mu V$. These features make the LMP7715/LMP7716/LMP7716Q superior choices for precision applications.

Consuming only 1.15 mA of supply current, the LMP7715 offers a high gain bandwidth product of 17 MHz, enabling accurate amplification at high closed loop gains.

The LMP7715/LMP7716/LMP7716Q have a supply voltage range of 1.8V to 5.5V, which makes these ideal choices for portable low power applications with low supply voltage requirements.

The LMP7715/LMP7716/LMP7716Q are built with TI's advanced VIP50 process technology. The LMP7715 is offered in a 5-pin SOT-23 package and the LMP7716/LMP7716Q is offered in an 8-pin VSSOP.

The LMP7716Q incorporates enhanced manufacturing and support processes for the automotive market, including defect detection methodologies. Reliability qualification is compliant with the requirements and temperature grades defined in the AEC-Q100 standard.



Please be aware that an important notice concerning availability, standard warranty, and use in critical applications of Texas Instruments semiconductor products and disclaimers thereto appears at the end of this data sheet.

LMP is a trademark of Texas Instruments.

All other trademarks are the property of their respective owners.

Typical Performance

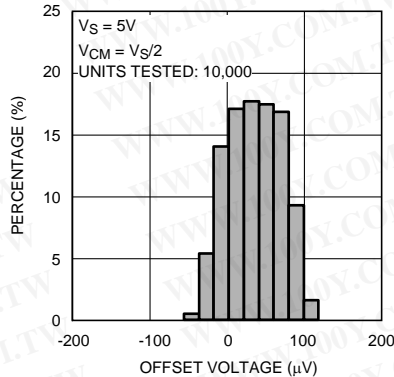

Figure 1. Offset Voltage Distribution

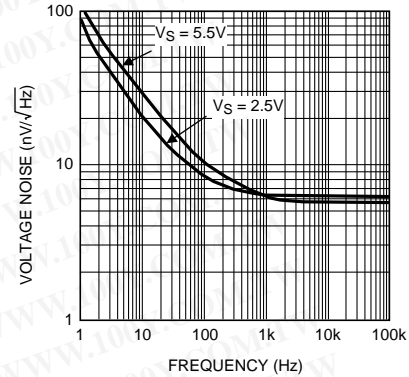

Figure 2. Input Referred Voltage Noise



These devices have limited built-in ESD protection. The leads should be shorted together or the device placed in conductive foam during storage or handling to prevent electrostatic damage to the MOS gates.

Absolute Maximum Ratings⁽¹⁾⁽²⁾

ESD Tolerance ⁽³⁾	Human Body Model	2000V
	Machine Model	200V
	Charge-Device Model	1000V
V_{IN} Differential		$\pm 0.3V$
Supply Voltage ($V_S = V^+ - V^-$)		6.0V
Voltage on Input/Output Pins		$V^+ + 0.3V, V^- - 0.3V$
Storage Temperature Range		$-65^\circ C$ to $150^\circ C$
Junction Temperature ⁽⁴⁾		$+150^\circ C$
Soldering Information	Infrared or Convection (20 sec)	$235^\circ C$
	Wave Soldering Lead Temp. (10 sec)	$260^\circ C$

- (1) Absolute Maximum Ratings indicate limits beyond which damage to the device may occur. Operating Ratings indicate conditions for which the device is intended to be functional, but specific performance is not ensured. For ensured specifications and the test conditions, see the Electrical Characteristics Tables.
- (2) If Military/Aerospace specified devices are required, please contact the Texas Instruments Sales Office/ Distributors for availability and specifications.
- (3) Human Body Model, applicable std. MIL-STD-883, Method 3015.7. Machine Model, applicable std. JESD22-A115-A (ESD MM std. of JEDEC) Field-Induced Charge-Device Model, applicable std. JESD22-C101-C (ESD FICDM std. of JEDEC).
- (4) The maximum power dissipation is a function of $T_{J(MAX)}$, θ_{JA} . The maximum allowable power dissipation at any ambient temperature is $P_D = (T_{J(MAX)} - T_A)/\theta_{JA}$. All numbers apply for packages soldered directly onto a PC Board.

Operating Ratings⁽¹⁾

Temperature Range ⁽²⁾		$-40^\circ C$ to $125^\circ C$
Supply Voltage ($V_S = V^+ - V^-$)	$0^\circ C \leq T_A \leq 125^\circ C$	1.8V to 5.5V
	$-40^\circ C \leq T_A \leq 125^\circ C$	2.0V to 5.5V
Package Thermal Resistance (θ_{JA}) ⁽²⁾	5-Pin SOT-23	$180^\circ C/W$
	8-Pin VSSOP	$236^\circ C/W$

- (1) Absolute Maximum Ratings indicate limits beyond which damage to the device may occur. Operating Ratings indicate conditions for which the device is intended to be functional, but specific performance is not ensured. For ensured specifications and the test conditions, see the Electrical Characteristics Tables.
- (2) The maximum power dissipation is a function of $T_{J(MAX)}$, θ_{JA} . The maximum allowable power dissipation at any ambient temperature is $P_D = (T_{J(MAX)} - T_A)/\theta_{JA}$. All numbers apply for packages soldered directly onto a PC Board.

2.5V Electrical Characteristics

Unless otherwise specified, all limits are ensured for $T_A = 25^\circ\text{C}$, $V^+ = 2.5\text{V}$, $V^- = 0\text{V}$, $V_O = V_{CM} = V^+/2$. **Boldface** limits apply at the temperature extremes.

Symbol	Parameter	Conditions	Min ⁽¹⁾	Typ ⁽²⁾	Max ⁽¹⁾	Units
V_{OS}	Input Offset Voltage	$-20^\circ\text{C} \leq T_A \leq 85^\circ\text{C}$		± 20	± 180 ± 330	μV
		$-40^\circ\text{C} \leq T_A \leq 125^\circ\text{C}$		± 20	± 180 ± 430	
TC V_{OS}	Input Offset Voltage Temperature Drift ⁽³⁾⁽⁴⁾	LMP7715		-1	± 4	$\mu\text{V}/^\circ\text{C}$
		LMP7716/LMP7716Q		-1.75		
I_B	Input Bias Current	$V_{CM} = 1.0\text{V}^{(4)(5)}$	$-40^\circ\text{C} \leq T_A \leq 85^\circ\text{C}$	0.05	1 25	pA
			$-40^\circ\text{C} \leq T_A \leq 125^\circ\text{C}$	0.05	1 100	
I_{OS}	Input Offset Current	$V_{CM} = 1\text{V}^{(4)}$		0.006	0.5 50	pA
CMRR	Common Mode Rejection Ratio	$0\text{V} \leq V_{CM} \leq 1.4\text{V}$	83 80	100		dB
PSRR	Power Supply Rejection Ratio	$2.0\text{V} \leq V^+ \leq 5.5\text{V}$ $V^- = 0\text{V}$, $V_{CM} = 0$	85 80	100		dB
		$1.8\text{V} \leq V^+ \leq 5.5\text{V}$ $V^- = 0\text{V}$, $V_{CM} = 0$	85	98		
CMVR	Common Mode Voltage Range	CMRR ≥ 80 dB CMRR ≥ 78 dB	-0.3 -0.3		1.5 1.5	V
A_{VOL}	Open Loop Voltage Gain	LMP7715, $V_O = 0.15$ to 2.2V $R_L = 2\text{ k}\Omega$ to $V^+/2$	88 82	98		dB
		LMP7716/LMP7716Q, $V_O = 0.15$ to 2.2V $R_L = 2\text{ k}\Omega$ to $V^+/2$	84 80	92		
		LMP7715, $V_O = 0.15$ to 2.2V $R_L = 10\text{ k}\Omega$ to $V^+/2$	92 88	110		
		LMP7716/ LMP7716Q, $V_O = 0.15$ to 2.2V $R_L = 10\text{ k}\Omega$ to $V^+/2$	90 86	95		
V_{OUT}	Output Voltage Swing High	$R_L = 2\text{ k}\Omega$ to $V^+/2$		25	70 77	mV from either rail
		$R_L = 10\text{ k}\Omega$ to $V^+/2$		20	60 66	
	Output Voltage Swing Low	$R_L = 2\text{ k}\Omega$ to $V^+/2$		30	70 73	
		$R_L = 10\text{ k}\Omega$ to $V^+/2$		15	60 62	
I_{OUT}	Output Current	Sourcing to V^- $V_{IN} = 200\text{ mV}^{(6)}$	36 30	52		mA
		Sinking to V^+ $V_{IN} = -200\text{ mV}^{(6)}$	7.5 5.0	15		
I_S	Supply Current	LMP7715		0.95	1.30 1.65	mA
		LMP7716/LMP7716Q (per channel)		1.10	1.50 1.85	
SR	Slew Rate	$A_V = +1$, Rising (10% to 90%)		8.3		V/ μs
		$A_V = +1$, Falling (90% to 10%)		10.3		

- (1) Limits are 100% production tested at 25°C . Limits over the operating temperature range are specified through correlations using the Statistical Quality Control (SQC) method.
- (2) Typical values represent the most likely parametric norm as determined at the time of characterization. Actual typical values may vary over time and will also depend on the application and configuration. The typical values are not tested and are not specified on shipped production material.
- (3) Offset voltage average drift is determined by dividing the change in V_{OS} at the temperature extremes by the total temperature change.
- (4) This parameter is specified by design and/or characterization and is not tested in production.
- (5) Positive current corresponds to current flowing into the device.
- (6) The short circuit test is a momentary open loop test.

2.5V Electrical Characteristics (continued)

Unless otherwise specified, all limits are ensured for $T_A = 25^\circ\text{C}$, $V^+ = 2.5\text{V}$, $V^- = 0\text{V}$, $V_O = V_{CM} = V^+/2$. **Boldface** limits apply at the temperature extremes.

Symbol	Parameter	Conditions	Min ⁽¹⁾	Typ ⁽²⁾	Max ⁽¹⁾	Units
GBW	Gain Bandwidth			14		MHz
e_n	Input Referred Voltage Noise Density	$f = 400\text{ Hz}$		6.8		nV/
		$f = 1\text{ kHz}$		5.8		
i_n	Input Referred Current Noise Density	$f = 1\text{ kHz}$		0.01		pA/ $\sqrt{\text{Hz}}$
THD+N	Total Harmonic Distortion + Noise	$f = 1\text{ kHz}$, $A_V = 1$, $R_L = 100\text{ k}\Omega$ $V_O = 0.9 V_{PP}$		0.003		%
		$f = 1\text{ kHz}$, $A_V = 1$, $R_L = 600\Omega$ $V_O = 0.9 V_{PP}$		0.004		

5V Electrical Characteristics

Unless otherwise specified, all limits are ensured for $T_A = 25^\circ\text{C}$, $V^+ = 5\text{V}$, $V^- = 0\text{V}$, $V_{CM} = V^+/2$. **Boldface** limits apply at the temperature extremes.

Symbol	Parameter	Conditions	Min ⁽¹⁾	Typ ⁽²⁾	Max ⁽¹⁾	Units
V_{OS}	Input Offset Voltage	$-20^\circ\text{C} \leq T_A \leq 85^\circ\text{C}$		± 10	± 150 ± 300	μV
		$-40^\circ\text{C} \leq T_A \leq 125^\circ\text{C}$		± 10	± 150 ± 400	
TC V_{OS}	Input Offset Voltage Temperature Drift ⁽³⁾⁽⁴⁾	LMP7715		-1	± 4	$\mu\text{V}/^\circ\text{C}$
		LMP7716/LMP7716Q		-1.75		
I_B	Input Bias Current	$V_{CM} = 2.0\text{V}^{(4)(5)}$	$-40^\circ\text{C} \leq T_A \leq 85^\circ\text{C}$	0.1	1 25	pA
			$-40^\circ\text{C} \leq T_A \leq 125^\circ\text{C}$	0.1	1 100	
I_{OS}	Input Offset Current	$V_{CM} = 2.0\text{V}^{(4)}$		0.01	0.5 50	pA
CMRR	Common Mode Rejection Ratio	$0\text{V} \leq V_{CM} \leq 3.7\text{V}$	85 82	100		dB
PSRR	Power Supply Rejection Ratio	$2.0\text{V} \leq V^+ \leq 5.5\text{V}$ $V^- = 0\text{V}$, $V_{CM} = 0$	85 80	100		dB
		$1.8\text{V} \leq V^+ \leq 5.5\text{V}$ $V^- = 0\text{V}$, $V_{CM} = 0$	85	98		
CMVR	Common Mode Voltage Range	CMRR $\geq 80\text{ dB}$ CMRR $\geq 78\text{ dB}$	-0.3 -0.3		4 4	V
A_{VOL}	Open Loop Voltage Gain	LMP7715, $V_O = 0.3\text{ to }4.7\text{V}$ $R_L = 2\text{ k}\Omega\text{ to }V^+/2$	88 82	107		dB
		LMP7716/LMP7716Q, $V_O = 0.3\text{ to }4.7\text{V}$ $R_L = 2\text{ k}\Omega\text{ to }V^+/2$	84 80	90		
		LMP7715, $V_O = 0.3\text{ to }4.7\text{V}$ $R_L = 10\text{ k}\Omega\text{ to }V^+/2$	92 88	110		
		LMP7716/LMP7716Q, $V_O = 0.3\text{ to }4.7\text{V}$ $R_L = 10\text{ k}\Omega\text{ to }V^+/2$	90 86	95		

- (1) Limits are 100% production tested at 25°C . Limits over the operating temperature range are specified through correlations using the Statistical Quality Control (SQC) method.
- (2) Typical values represent the most likely parametric norm as determined at the time of characterization. Actual typical values may vary over time and will also depend on the application and configuration. The typical values are not tested and are not specified on shipped production material.
- (3) Offset voltage average drift is determined by dividing the change in V_{OS} at the temperature extremes by the total temperature change.
- (4) This parameter is specified by design and/or characterization and is not tested in production.
- (5) Positive current corresponds to current flowing into the device.

5V Electrical Characteristics (continued)

Unless otherwise specified, all limits are ensured for $T_A = 25^\circ\text{C}$, $V^+ = 5\text{V}$, $V^- = 0\text{V}$, $V_{\text{CM}} = V^+/2$. **Boldface** limits apply at the temperature extremes.

Symbol	Parameter	Conditions	Min ⁽¹⁾	Typ ⁽²⁾	Max ⁽¹⁾	Units
V_{OUT}	Output Voltage Swing High	$R_L = 2\text{ k}\Omega$ to $V^+/2$		32	70 77	mV from either rail
		$R_L = 10\text{ k}\Omega$ to $V^+/2$		22	60 66	
	Output Voltage Swing Low	$R_L = 2\text{ k}\Omega$ to $V^+/2$ (LMP7715)		42	70 73	
		$R_L = 2\text{ k}\Omega$ to $V^+/2$ (LMP7716/LMP7716Q)		45	75 78	
		$R_L = 10\text{ k}\Omega$ to $V^+/2$		20	60 62	
I_{OUT}	Output Current	Sourcing to V^- $V_{\text{IN}} = 200\text{ mV}^{(6)}$	46 38	66		mA
		Sinking to V^+ $V_{\text{IN}} = -200\text{ mV}^{(6)}$	10.5 6.5	23		
I_S	Supply Current	LMP7715		1.15	1.40 1.75	mA
		LMP7716/LMP7716Q (per channel)		1.30	1.70 2.05	
SR	Slew Rate	$A_V = +1$, Rising (10% to 90%)	6.0	9.5		$\text{V}/\mu\text{s}$
		$A_V = +1$, Falling (90% to 10%)	7.5	11.5		
GBW	Gain Bandwidth			17		MHz
e_n	Input Referred Voltage Noise Density	$f = 400\text{ Hz}$		7.0		$\text{nV}/\sqrt{\text{Hz}}$
		$f = 1\text{ kHz}$		5.8		
i_n	Input Referred Current Noise Density	$f = 1\text{ kHz}$		0.01		$\text{pA}/\sqrt{\text{Hz}}$
THD+N	Total Harmonic Distortion + Noise	$f = 1\text{ kHz}$, $A_V = 1$, $R_L = 100\text{ k}\Omega$ $V_O = 4\text{ V}_{\text{PP}}$		0.001		%
		$f = 1\text{ kHz}$, $A_V = 1$, $R_L = 600\Omega$ $V_O = 4\text{ V}_{\text{PP}}$		0.004		

(6) The short circuit test is a momentary open loop test.

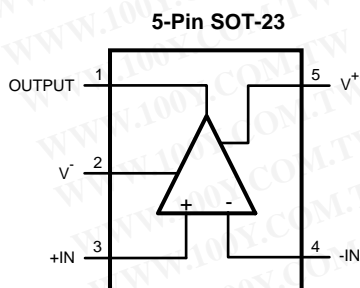
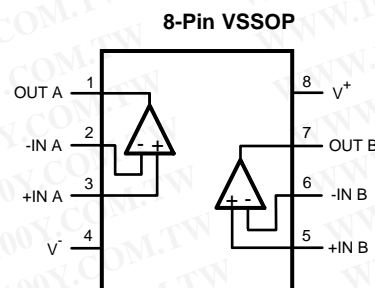
Connection Diagram

Figure 3. Top View

Figure 4. Top View

Typical Performance Characteristics

Unless otherwise noted: $T_A = 25^\circ\text{C}$, $V_S = 5\text{V}$, $V_{CM} = V_S/2$.

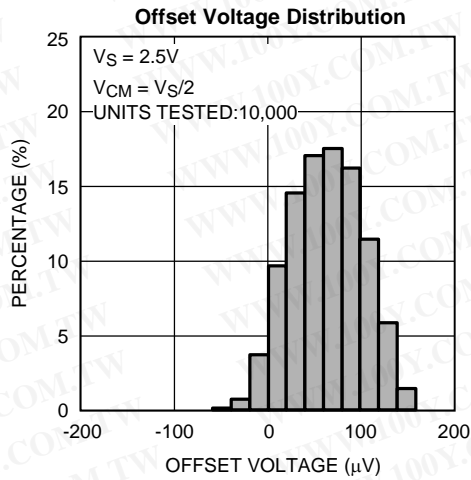

Figure 5.

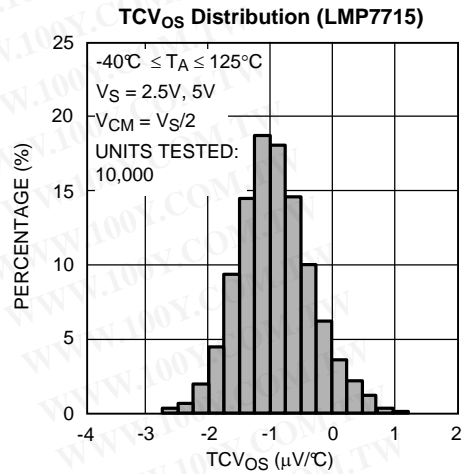

Figure 6.

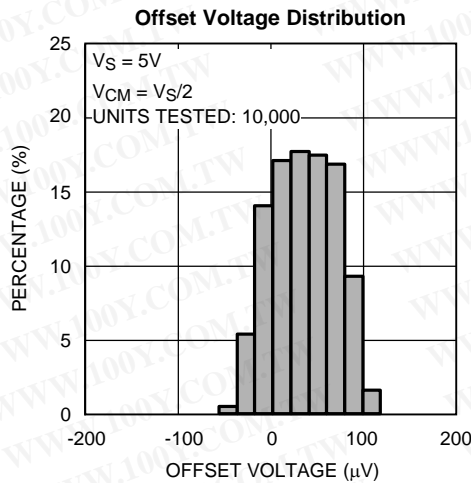

Figure 7.

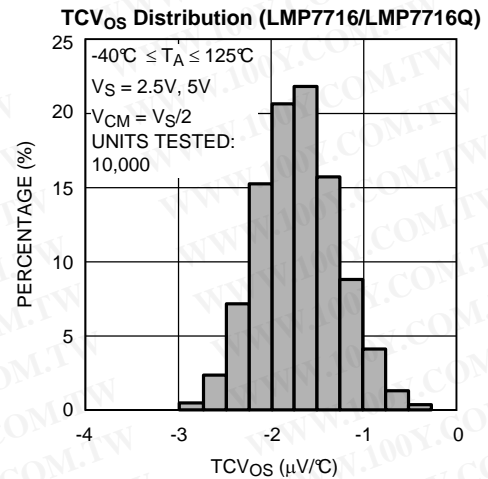

Figure 8.

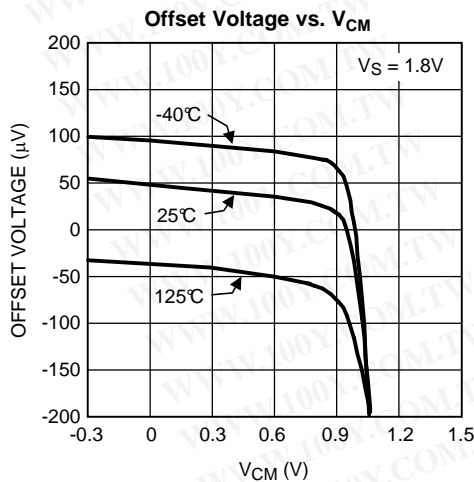

Figure 9.

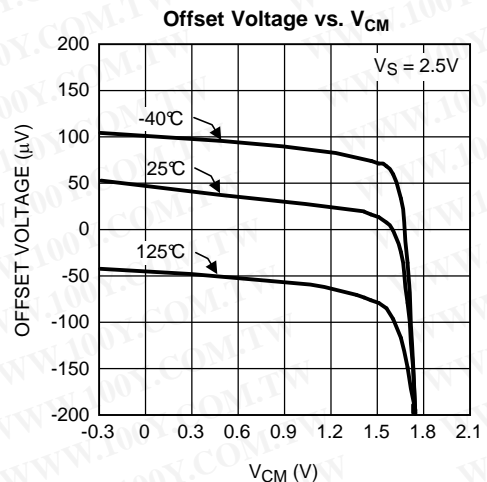

Figure 10.

Typical Performance Characteristics (continued)

Unless otherwise noted: $T_A = 25^\circ\text{C}$, $V_S = 5\text{V}$, $V_{CM} = V_S/2$.

Offset Voltage vs. V_{CM}

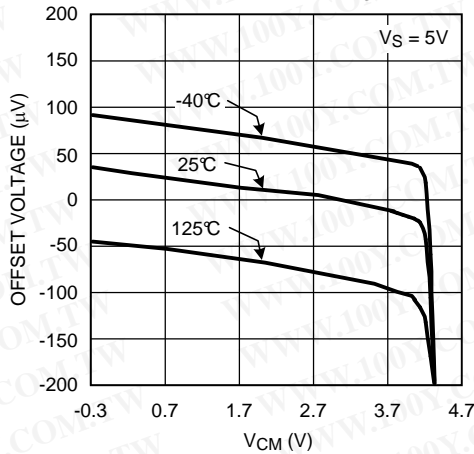

Figure 11.

Offset Voltage vs. Supply Voltage

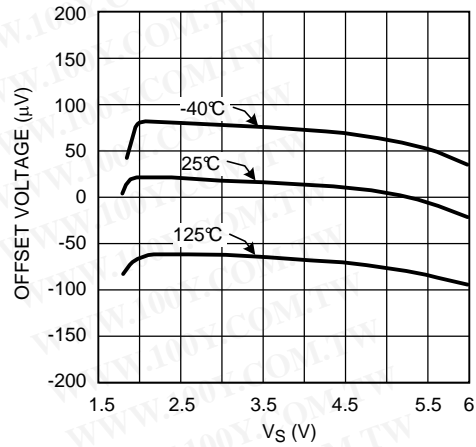

Figure 12.

Offset Voltage vs. Temperature

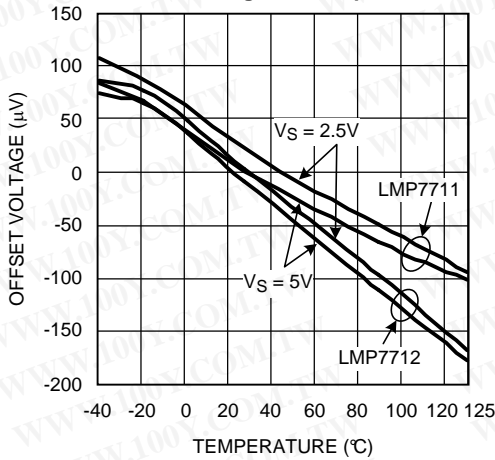

Figure 13.

CMRR vs. Frequency

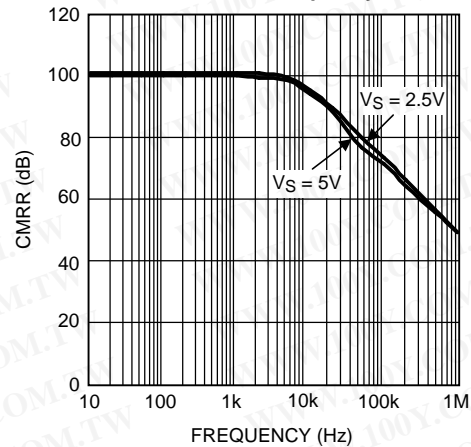

Figure 14.

Input Bias Current vs. V_{CM}

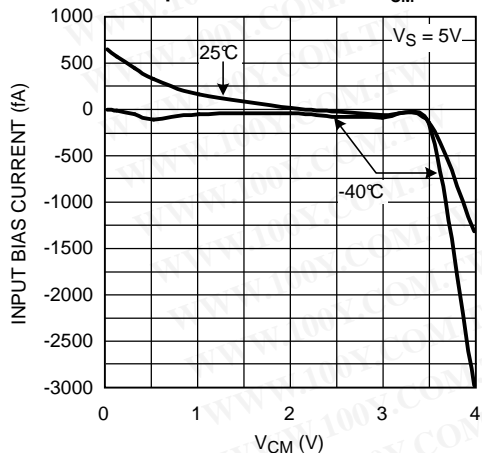

Figure 15.

Input Bias Current vs. V_{CM}

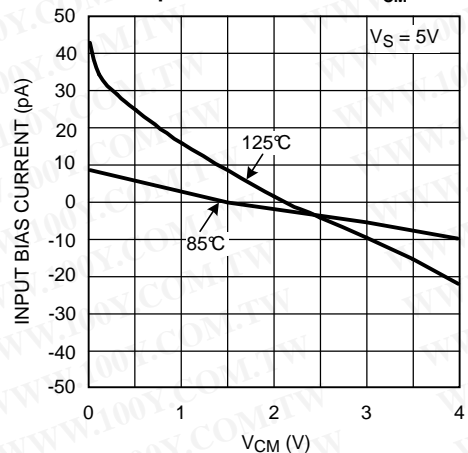

Figure 16.

Typical Performance Characteristics (continued)

Unless otherwise noted: $T_A = 25^\circ\text{C}$, $V_S = 5\text{V}$, $V_{CM} = V_S/2$.

Supply Current vs. Supply Voltage (LMP7715)

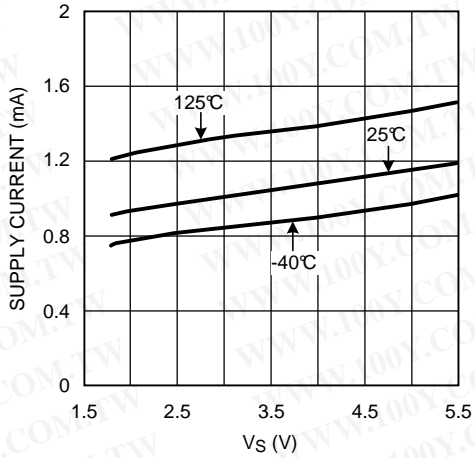

Figure 17.

Supply Current vs. Supply Voltage (LMP7716/LMP7716Q)

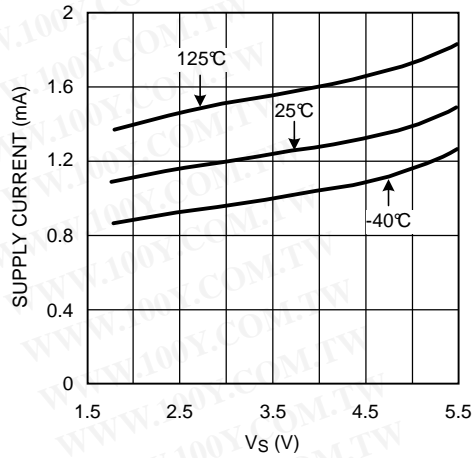

Figure 18.

Crosstalk Rejection Ratio (LMP7716/LMP7716Q)

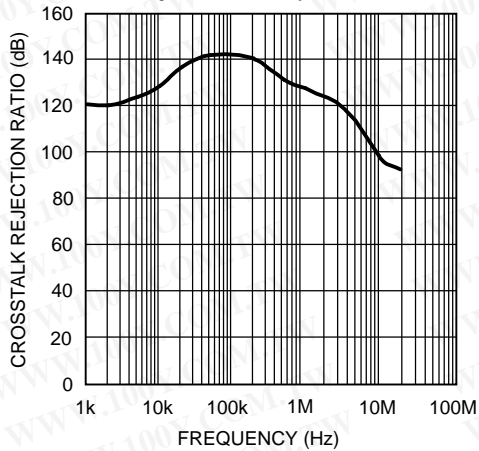

Figure 19.

Sourcing Current vs. Supply Voltage

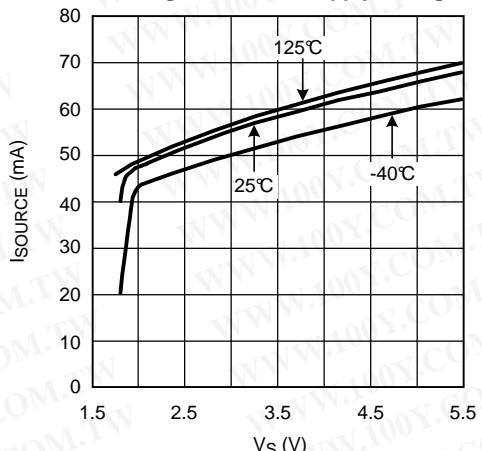

Figure 20.

Sinking Current vs. Supply Voltage

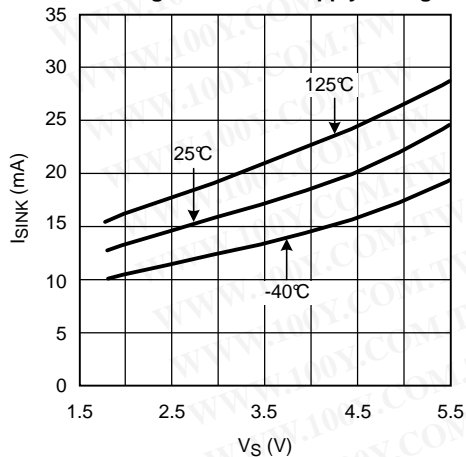

Figure 21.

Sourcing Current vs. Output Voltage

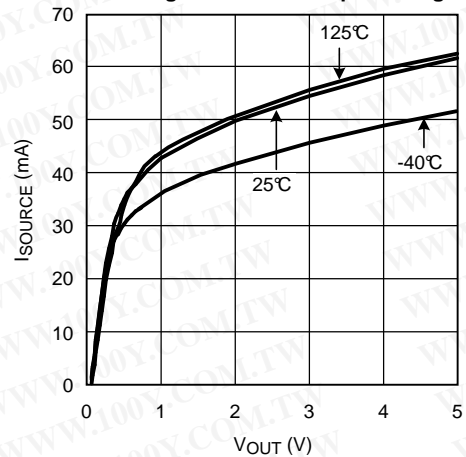

Figure 22.

Typical Performance Characteristics (continued)

Unless otherwise noted: $T_A = 25^\circ\text{C}$, $V_S = 5\text{V}$, $V_{CM} = V_S/2$.

Sinking Current vs. Output Voltage

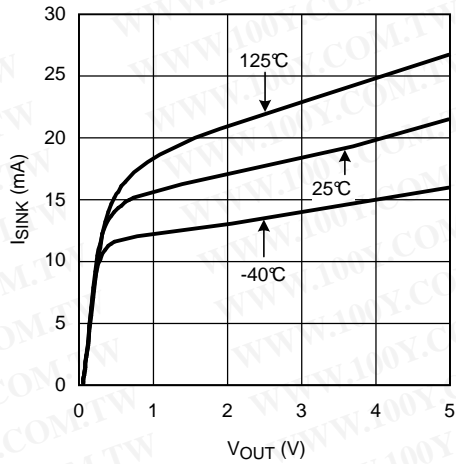

Figure 23.

Output Swing High vs. Supply Voltage

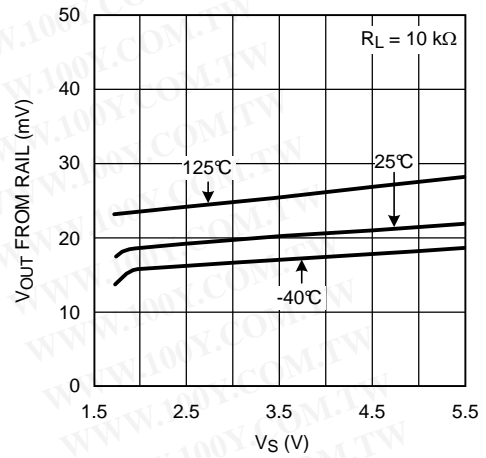

Figure 24.

Output Swing Low vs. Supply Voltage

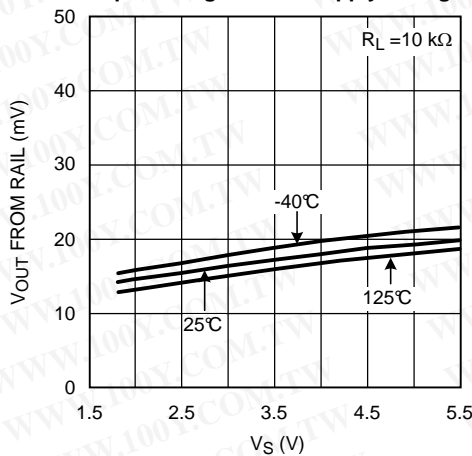

Figure 25.

Output Swing High vs. Supply Voltage

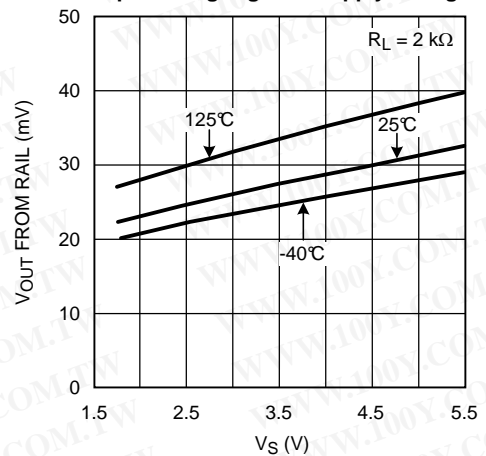

Figure 26.

Output Swing Low vs. Supply Voltage

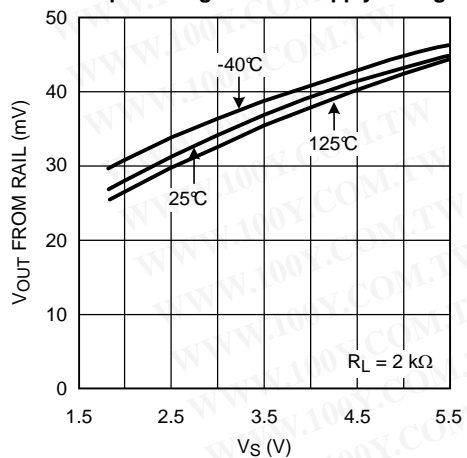

Figure 27.

Output Swing High vs. Supply Voltage

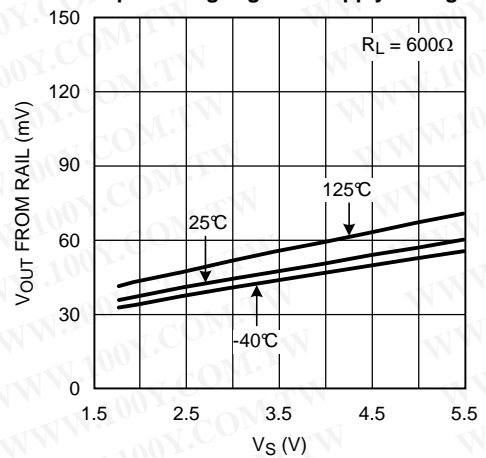

Figure 28.

Typical Performance Characteristics (continued)

Unless otherwise noted: $T_A = 25^\circ\text{C}$, $V_S = 5\text{V}$, $V_{CM} = V_S/2$.

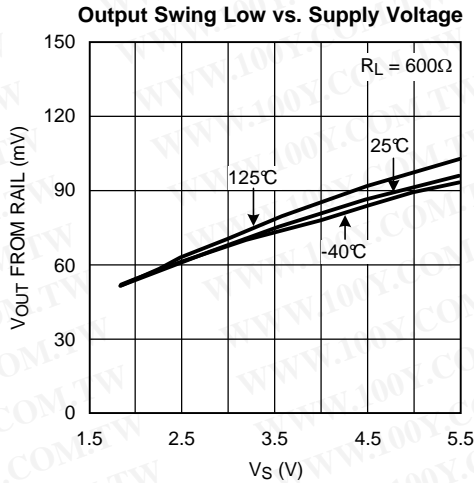

Figure 29.

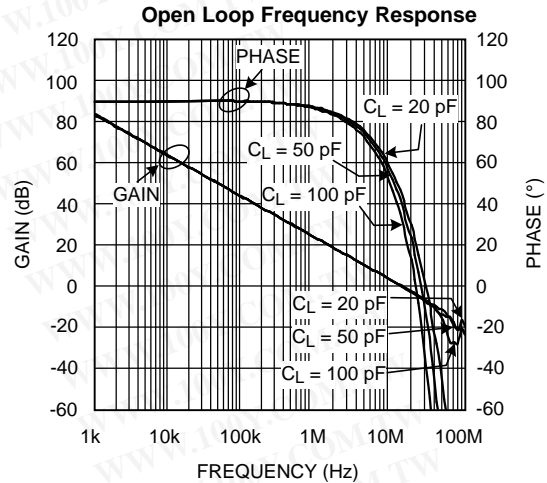

Figure 30.

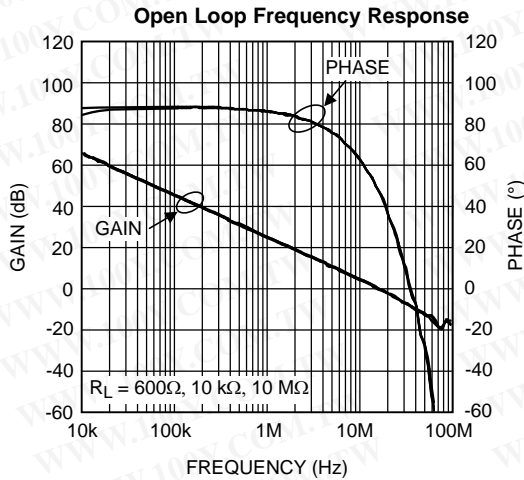

Figure 31.

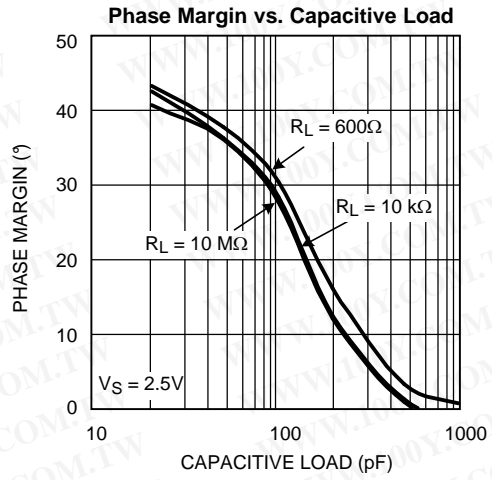

Figure 32.

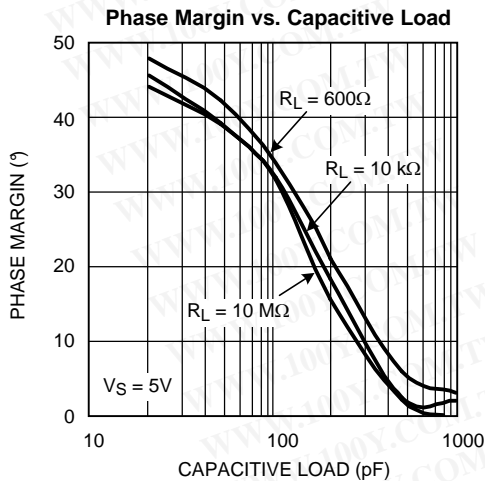

Figure 33.

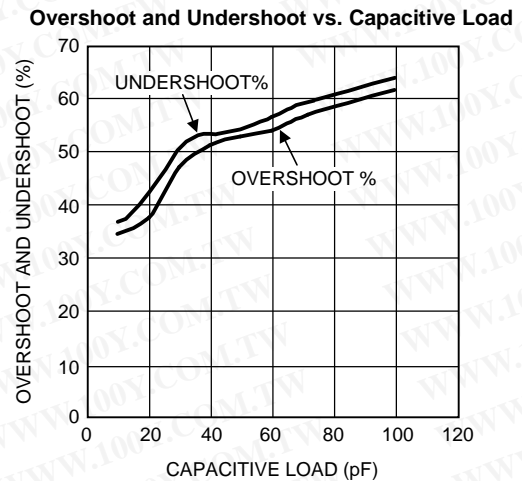

Figure 34.

Typical Performance Characteristics (continued)

Unless otherwise noted: $T_A = 25^\circ\text{C}$, $V_S = 5\text{V}$, $V_{CM} = V_S/2$.

Slew Rate vs. Supply Voltage

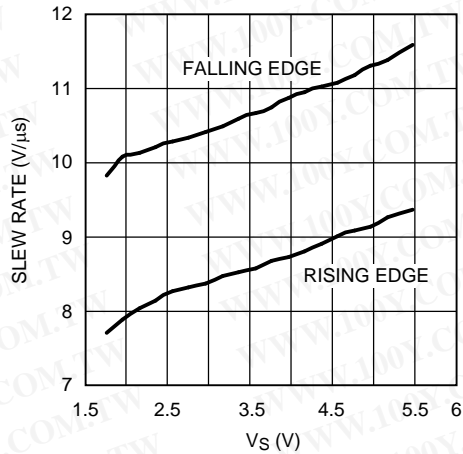

Figure 35.

Small Signal Step Response

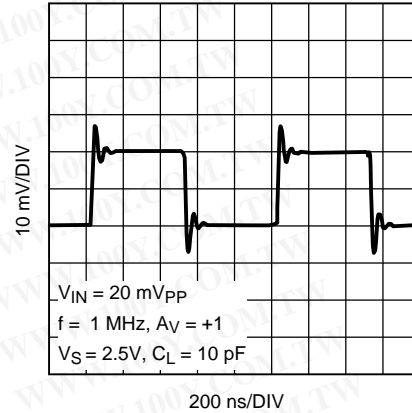

Figure 36.

Large Signal Step Response

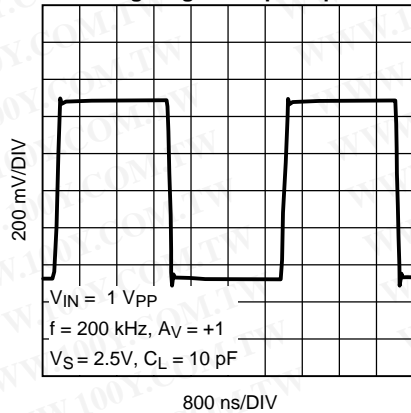

Figure 37.

Small Signal Step Response

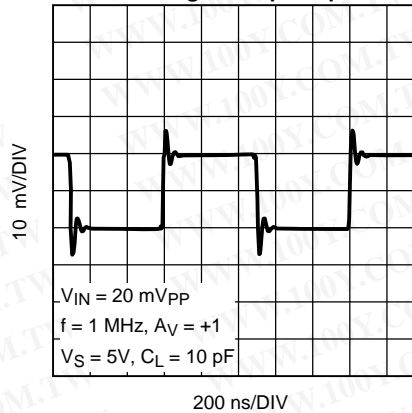

Figure 38.

Large Signal Step Response

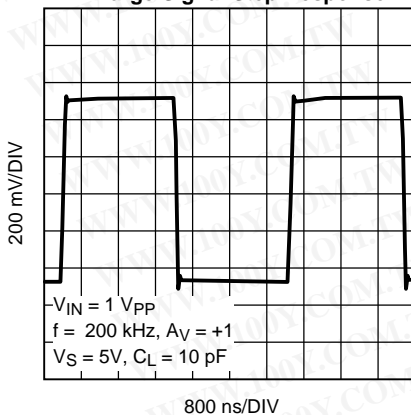

Figure 39.

THD+N vs. Output Voltage

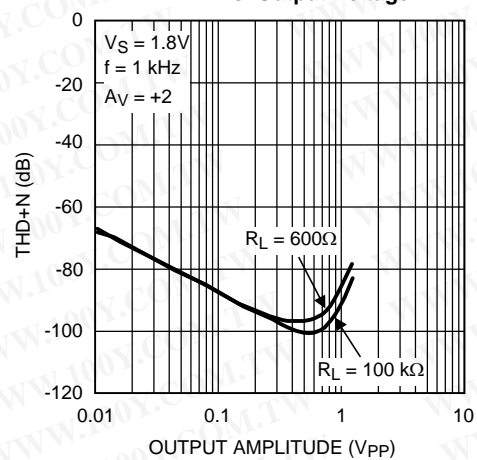

Figure 40.

Typical Performance Characteristics (continued)

Unless otherwise noted: $T_A = 25^\circ\text{C}$, $V_S = 5\text{V}$, $V_{CM} = V_S/2$.

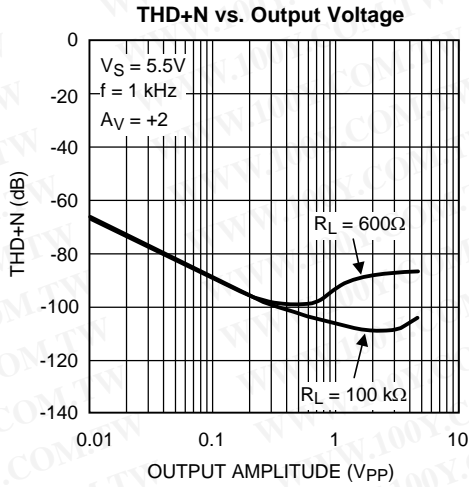

Figure 41.

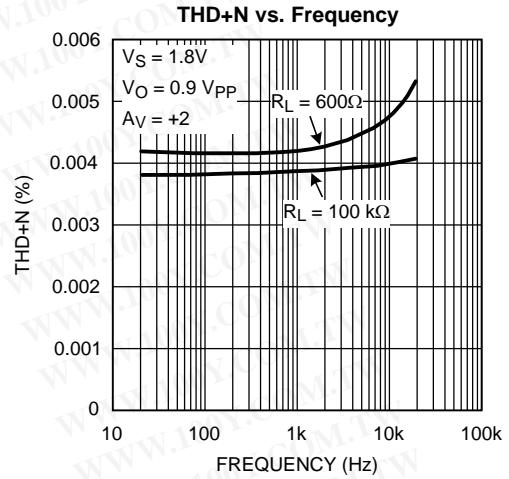

Figure 42.

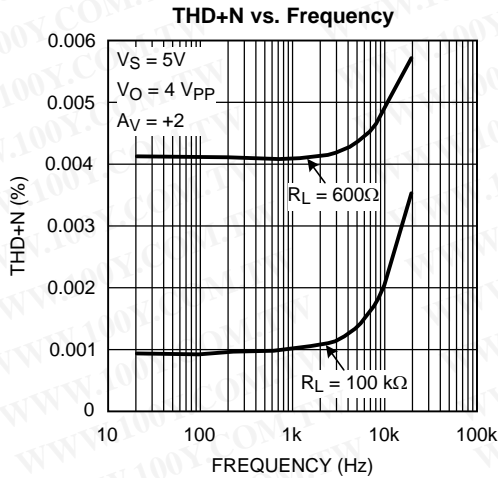

Figure 43.

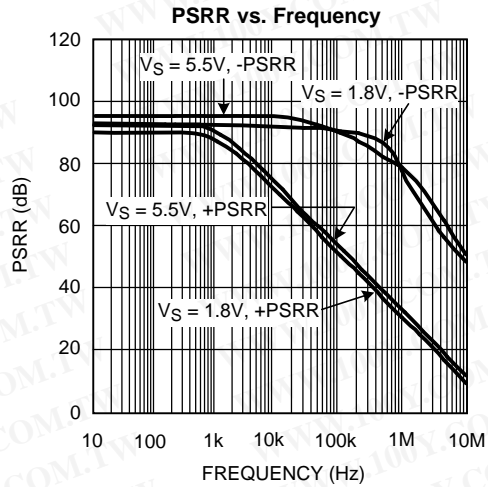

Figure 44.

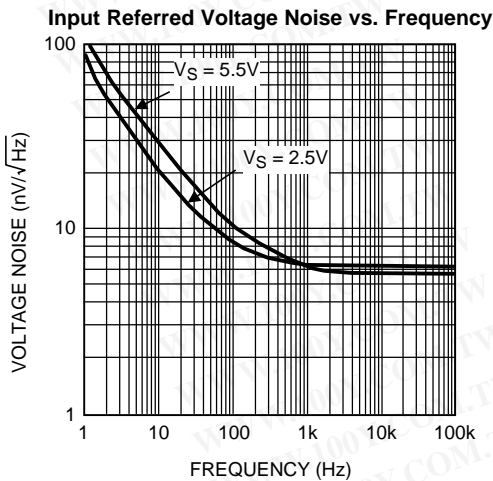

Figure 45.

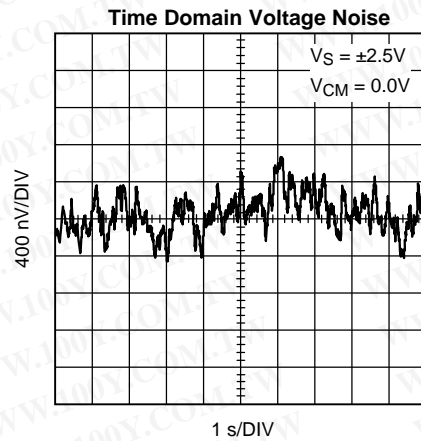

Figure 46.

Typical Performance Characteristics (continued)

Unless otherwise noted: $T_A = 25^\circ\text{C}$, $V_S = 5\text{V}$, $V_{CM} = V_S/2$.

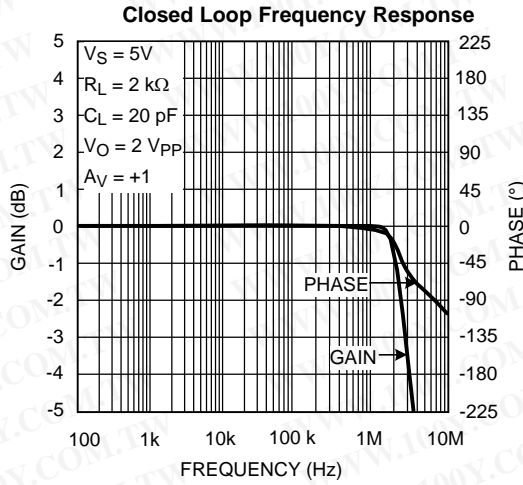

Figure 47.

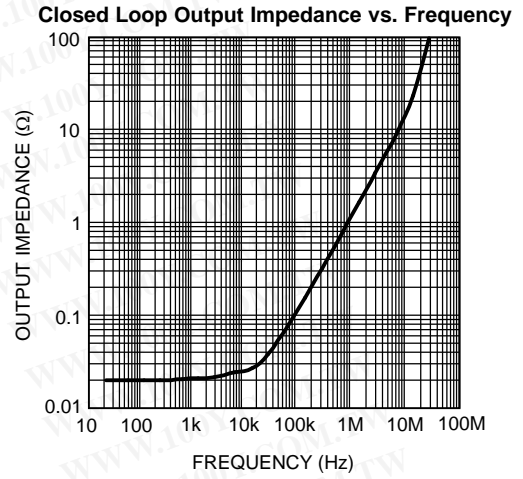

Figure 48.

APPLICATION INFORMATION

LMP7715/LMP7716/LMP7716Q

The LMP7715/LMP7716/LMP7716Q are single and dual, low noise, low offset, rail-to-rail output precision amplifiers with a wide gain bandwidth product of 17 MHz and low supply current. The wide bandwidth makes the LMP7715/LMP7716/LMP7716Q ideal choices for wide-band amplification in portable applications.

The LMP7715/LMP7716/LMP7716Q are superior for sensor applications. The very low input referred voltage noise of only $5.8 \text{ nV}/\sqrt{\text{Hz}}$ at 1 kHz and very low input referred current noise of only $10 \text{ fA}/\sqrt{\text{Hz}}$ mean more signal fidelity and higher signal-to-noise ratio.

The LMP7715/LMP7716/LMP7716Q have a supply voltage range of 1.8V to 5.5V over a wide temperature range of 0°C to 125°C . This is optimal for low voltage commercial applications. For applications where the ambient temperature might be less than 0°C , the LMP7715/LMP7716/LMP7716Q are fully operational at supply voltages of 2.0V to 5.5V over the temperature range of -40°C to 125°C .

The outputs of the LMP7715/LMP7716/LMP7716Q swing within 25 mV of either rail providing maximum dynamic range in applications requiring low supply voltage. The input common mode range of the LMP7715/LMP7716/LMP7716Q extends to 300 mV below ground. This feature enables users to utilize this device in single supply applications.

The use of a very innovative feedback topology has enhanced the current drive capability of the LMP7715/LMP7716/LMP7716Q, resulting in sourcing currents of as much as 47 mA with a supply voltage of only 1.8V.

The LMP7715 is offered in the space saving SOT-23 package and the LMP7716/LMP7716Q is offered in an 8-pin VSSOP. These small packages are ideal solutions for applications requiring minimum PC board footprint.

CAPACITIVE LOAD

The unity gain follower is the most sensitive configuration to capacitive loading. The combination of a capacitive load placed directly on the output of an amplifier along with the output impedance of the amplifier creates a phase lag which in turn reduces the phase margin of the amplifier. If phase margin is significantly reduced, the response will be either underdamped or the amplifier will oscillate.

The LMP7715/LMP7716/LMP7716Q can directly drive capacitive loads of up to 120 pF without oscillating. To drive heavier capacitive loads, an isolation resistor, R_{ISO} as shown in Figure 49, should be used. This resistor and C_L form a pole and hence delay the phase lag or increase the phase margin of the overall system. The larger the value of R_{ISO} , the more stable the output voltage will be. However, larger values of R_{ISO} result in reduced output swing and reduced output current drive.

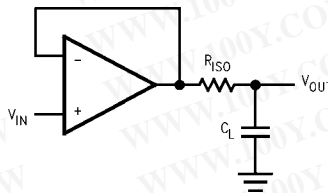

Figure 49. Isolating Capacitive Load

INPUT CAPACITANCE

CMOS input stages inherently have low input bias current and higher input referred voltage noise. The LMP7715/LMP7716/LMP7716Q enhance this performance by having the low input bias current of only 50 fA, as well as, a very low input referred voltage noise of $5.8 \text{ nV}/\sqrt{\text{Hz}}$. In order to achieve this a larger input stage has been used. This larger input stage increases the input capacitance of the LMP7715/LMP7716/LMP7716Q. Figure 50 shows typical input common mode capacitance of the LMP7715/LMP7716/LMP7716Q.

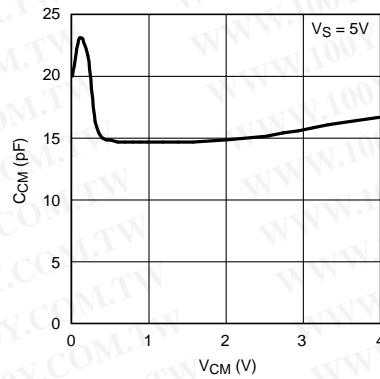
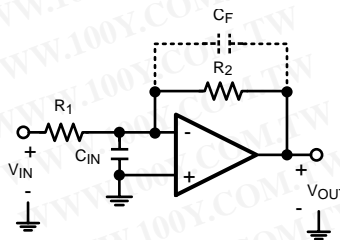

Figure 50. Input Common Mode Capacitance

This input capacitance will interact with other impedances, such as gain and feedback resistors which are seen on the inputs of the amplifier, to form a pole. This pole will have little or no effect on the output of the amplifier at low frequencies and under DC conditions, but will play a bigger role as the frequency increases. At higher frequencies, the presence of this pole will decrease phase margin and also cause gain peaking. In order to compensate for the input capacitance, care must be taken in choosing feedback resistors. In addition to being selective in picking values for the feedback resistor, a capacitor can be added to the feedback path to increase stability.

The DC gain of the circuit shown in Figure 51 is simply $-R_2/R_1$.



$$A_V = - \frac{V_{OUT}}{V_{IN}} = - \frac{R_2}{R_1}$$

Figure 51. Compensating for Input Capacitance

For the time being, ignore C_F . The AC gain of the circuit in Figure 51 can be calculated as follows:

$$\frac{V_{OUT}}{V_{IN}}(s) = \frac{-R_2/R_1}{1 + \frac{s}{\left(\frac{A_0 R_1}{R_1 + R_2}\right)} + \frac{s^2}{\left(\frac{A_0}{C_{IN} R_2}\right)}} \quad (1)$$

This equation is rearranged to find the location of the two poles:

$$P_{1,2} = \frac{-1}{2C_{IN}} \left[\frac{1}{R_1} + \frac{1}{R_2} \pm \sqrt{\left(\frac{1}{R_1} + \frac{1}{R_2}\right)^2 - \frac{4 A_0 C_{IN}}{R_2}} \right] \quad (2)$$

As shown in Equation 2, as the values of R_1 and R_2 are increased, the magnitude of the poles are reduced, which in turn decreases the bandwidth of the amplifier. Figure 52 shows the frequency response with different value resistors for R_1 and R_2 . Whenever possible, it is best to chose smaller feedback resistors.

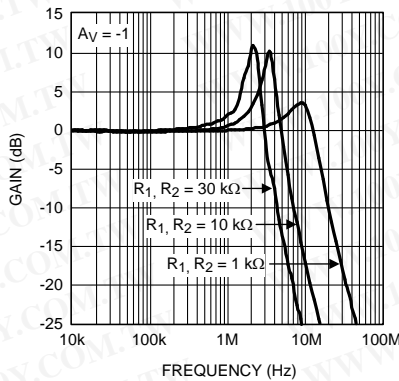

Figure 52. Closed Loop Frequency Response

As mentioned before, adding a capacitor to the feedback path will decrease the peaking. This is because C_F will form yet another pole in the system and will prevent pairs of poles, or complex conjugates from forming. It is the presence of pairs of poles that cause the peaking of gain. Figure 53 shows the frequency response of the schematic presented in Figure 51 with different values of C_F . As can be seen, using a small value capacitor significantly reduces or eliminates the peaking.

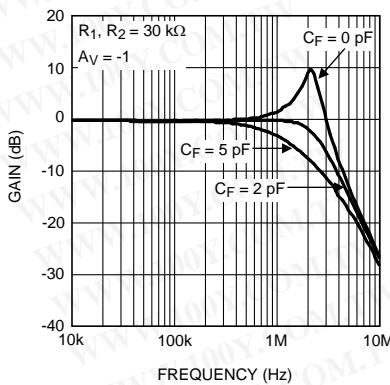

Figure 53. Closed Loop Frequency Response

TRANSIMPEDANCE AMPLIFIER

In many applications the signal of interest is a very small amount of current that needs to be detected. Current that is transmitted through a photodiode is a good example. Barcode scanners, light meters, fiber optic receivers, and industrial sensors are some typical applications utilizing photodiodes for current detection. This current needs to be amplified before it can be further processed. This amplification is performed using a current-to-voltage converter configuration or transimpedance amplifier. The signal of interest is fed to the inverting input of an op amp with a feedback resistor in the current path. The voltage at the output of this amplifier will be equal to the negative of the input current times the value of the feedback resistor. Figure 54 shows a transimpedance amplifier configuration. C_D represents the photodiode parasitic capacitance and C_{CM} denotes the common-mode capacitance of the amplifier. The presence of all of these capacitances at higher frequencies might lead to less stable topologies at higher frequencies. Care must be taken when designing a transimpedance amplifier to prevent the circuit from oscillating.

With a wide gain bandwidth product, low input bias current and low input voltage and current noise, the LMP7715/LMP7716/LMP7716Q are ideal for wideband transimpedance applications.

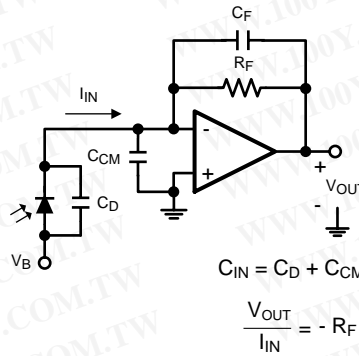

Figure 54. Transimpedance Amplifier

A feedback capacitance C_F is usually added in parallel with R_F to maintain circuit stability and to control the frequency response. To achieve a maximally flat, 2nd order response, R_F and C_F should be chosen by using Equation 3

$$C_F = \sqrt{\frac{C_{IN}}{GBWP * 2 \pi R_F}} \quad (3)$$

Calculating C_F from Equation 3 can sometimes result in capacitor values which are less than 2 pF. This is especially the case for high speed applications. In these instances, it is often more practical to use the circuit shown in Figure 55 in order to allow more sensible choices for C_F . The new feedback capacitor, C_F' , is $(1 + R_B/R_A) C_F$. This relationship holds as long as $R_A \ll R_F$.

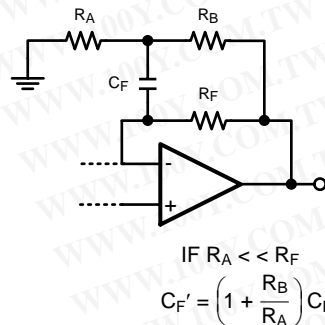

Figure 55. Modified Transimpedance Amplifier

SENSOR INTERFACE

The LMP7715/LMP7716/LMP7716Q have low input bias current and low input referred noise, which make them ideal choices for sensor interfaces such as thermopiles, Infra Red (IR) thermometry, thermocouple amplifiers, and pH electrode buffers.

Thermopiles generate voltage in response to receiving radiation. These voltages are often only a few microvolts. As a result, the operational amplifier used for this application needs to have low offset voltage, low input voltage noise, and low input bias current. Figure 56 shows a thermopile application where the sensor detects radiation from a distance and generates a voltage that is proportional to the intensity of the radiation. The two resistors, R_A and R_B , are selected to provide high gain to amplify this signal, while C_F removes the high frequency noise.

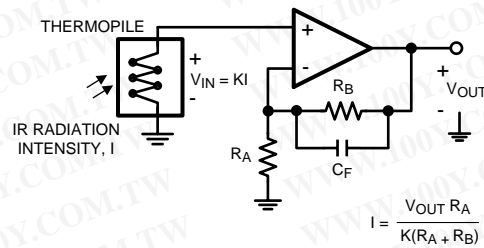

Figure 56. Thermopile Sensor Interface

PRECISION RECTIFIER

Rectifiers are electrical circuits used for converting AC signals to DC signals. Figure 57 shows a full-wave precision rectifier. Each operational amplifier used in this circuit has a diode on its output. This means for the diodes to conduct, the output of the amplifier needs to be positive with respect to ground. If V_{IN} is in its positive half cycle then only the output of the bottom amplifier will be positive. As a result, the diode on the output of the bottom amplifier will conduct and the signal will show at the output of the circuit. If V_{IN} is in its negative half cycle then the output of the top amplifier will be positive, resulting in the diode on the output of the top amplifier conducting and delivering the signal from the amplifier's output to the circuit's output.

For $R_2/R_1 \geq 2$, the resistor values can be found by using the equation shown in Figure 57. If $R_2/R_1 = 1$, then R_3 should be left open, no resistor needed, and R_4 should simply be shorted.

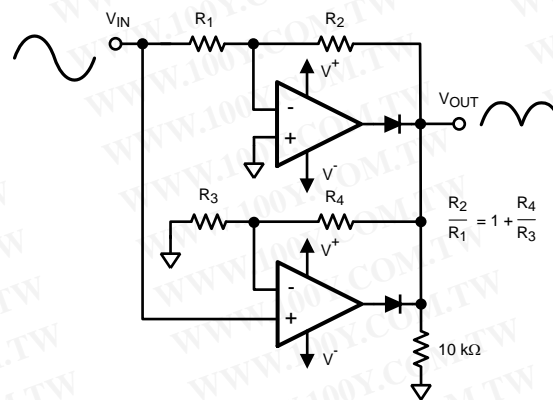

Figure 57. Precision Rectifier

REVISION HISTORY

Changes from Revision D (March 2013) to Revision E

Page

- Changed layout of National Data Sheet to TI format 18

PACKAGING INFORMATION

Orderable Device	Status (1)	Package Type	Package Drawing	Pins	Package Qty	Eco Plan (2)	Lead/Ball Finish	MSL Peak Temp (3)	Op Temp (°C)	Top-Side Markings (4)	Samples
LMP7715MF	ACTIVE	SOT-23	DBV	5	1000	TBD	Call TI	Call TI	-40 to 125	AV3A	Samples
LMP7715MF/NOPB	ACTIVE	SOT-23	DBV	5	1000	Green (RoHS & no Sb/Br)	CU SN	Level-1-260C-UNLIM	-40 to 125	AV3A	Samples
LMP7715MFE/NOPB	ACTIVE	SOT-23	DBV	5	250	Green (RoHS & no Sb/Br)	CU SN	Level-1-260C-UNLIM	-40 to 125	AV3A	Samples
LMP7715MFX	ACTIVE	SOT-23	DBV	5	3000	TBD	Call TI	Call TI	-40 to 125	AV3A	Samples
LMP7715MFX/NOPB	ACTIVE	SOT-23	DBV	5	3000	Green (RoHS & no Sb/Br)	CU SN	Level-1-260C-UNLIM	-40 to 125	AV3A	Samples
LMP7716MM	ACTIVE	VSSOP	DGK	8	1000	TBD	Call TI	Call TI	-40 to 125	AX3A	Samples
LMP7716MM/NOPB	ACTIVE	VSSOP	DGK	8	1000	Green (RoHS & no Sb/Br)	CU SN	Level-1-260C-UNLIM	-40 to 125	AX3A	Samples
LMP7716MME/NOPB	ACTIVE	VSSOP	DGK	8	250	Green (RoHS & no Sb/Br)	CU SN	Level-1-260C-UNLIM	-40 to 125	AX3A	Samples
LMP7716MMX	ACTIVE	VSSOP	DGK	8	3500	TBD	Call TI	Call TI	-40 to 125	AX3A	Samples
LMP7716MMX/NOPB	ACTIVE	VSSOP	DGK	8	3500	Green (RoHS & no Sb/Br)	CU SN	Level-1-260C-UNLIM	-40 to 125	AX3A	Samples
LMP7716QMM/NOPB	ACTIVE	VSSOP	DGK	8	1000	Green (RoHS & no Sb/Br)	CU SN	Level-1-260C-UNLIM	-40 to 125	AR5A	Samples
LMP7716QMME/NOPB	ACTIVE	VSSOP	DGK	8	250	Green (RoHS & no Sb/Br)	CU SN	Level-1-260C-UNLIM	-40 to 125	AR5A	Samples
LMP7716QMMX/NOPB	ACTIVE	VSSOP	DGK	8	3500	Green (RoHS & no Sb/Br)	CU SN	Level-1-260C-UNLIM	-40 to 125	AR5A	Samples

(1) The marketing status values are defined as follows:

ACTIVE: Product device recommended for new designs.

LIFEBUY: TI has announced that the device will be discontinued, and a lifetime-buy period is in effect.

NRND: Not recommended for new designs. Device is in production to support existing customers, but TI does not recommend using this part in a new design.

PREVIEW: Device has been announced but is not in production. Samples may or may not be available.

OBsolete: TI has discontinued the production of the device.

(2) Eco Plan - The planned eco-friendly classification: Pb-Free (RoHS), Pb-Free (RoHS Exempt), or Green (RoHS & no Sb/Br) - please check <http://www.ti.com/productcontent> for the latest availability information and additional product content details.

TBD: The Pb-Free/Green conversion plan has not been defined.

Pb-Free (RoHS): TI's terms "Lead-Free" or "Pb-Free" mean semiconductor products that are compatible with the current RoHS requirements for all 6 substances, including the requirement that lead not exceed 0.1% by weight in homogeneous materials. Where designed to be soldered at high temperatures, TI Pb-Free products are suitable for use in specified lead-free processes.

Pb-Free (RoHS Exempt): This component has a RoHS exemption for either 1) lead-based flip-chip solder bumps used between the die and package, or 2) lead-based die adhesive used between the die and leadframe. The component is otherwise considered Pb-Free (RoHS compatible) as defined above.

Green (RoHS & no Sb/Br): TI defines "Green" to mean Pb-Free (RoHS compatible), and free of Bromine (Br) and Antimony (Sb) based flame retardants (Br or Sb do not exceed 0.1% by weight in homogeneous material)

⁽³⁾ MSL, Peak Temp. -- The Moisture Sensitivity Level rating according to the JEDEC industry standard classifications, and peak solder temperature.

⁽⁴⁾ Multiple Top-Side Markings will be inside parentheses. Only one Top-Side Marking contained in parentheses and separated by a "~" will appear on a device. If a line is indented then it is a continuation of the previous line and the two combined represent the entire Top-Side Marking for that device.

Important Information and Disclaimer: The information provided on this page represents TI's knowledge and belief as of the date that it is provided. TI bases its knowledge and belief on information provided by third parties, and makes no representation or warranty as to the accuracy of such information. Efforts are underway to better integrate information from third parties. TI has taken and continues to take reasonable steps to provide representative and accurate information but may not have conducted destructive testing or chemical analysis on incoming materials and chemicals. TI and TI suppliers consider certain information to be proprietary, and thus CAS numbers and other limited information may not be available for release.

In no event shall TI's liability arising out of such information exceed the total purchase price of the TI part(s) at issue in this document sold by TI to Customer on an annual basis.

OTHER QUALIFIED VERSIONS OF LMP7716, LMP7716-Q1 :

- Catalog: [LMP7716](#)
- Automotive: [LMP7716-Q1](#)

NOTE: Qualified Version Definitions:

- Catalog - TI's standard catalog product
- Automotive - Q100 devices qualified for high-reliability automotive applications targeting zero defects

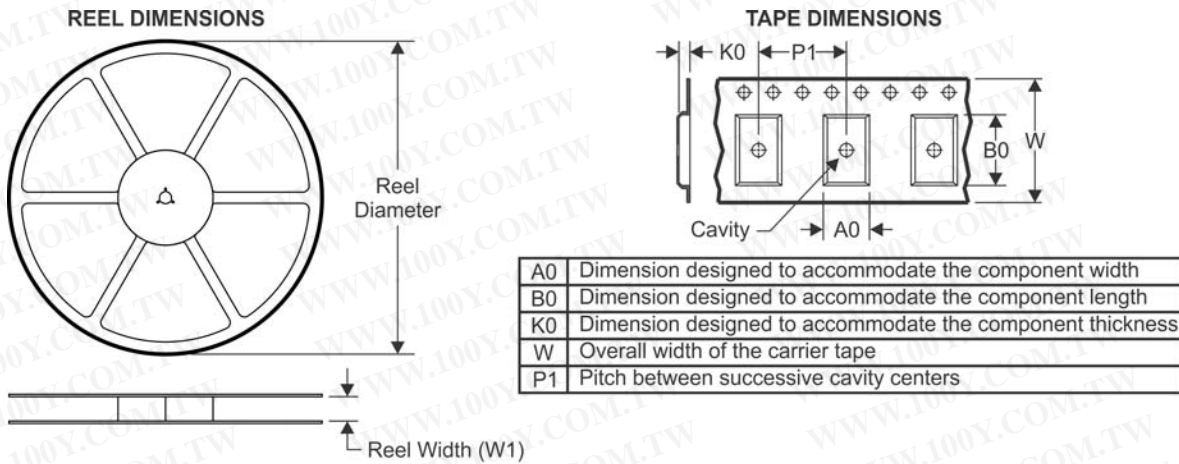
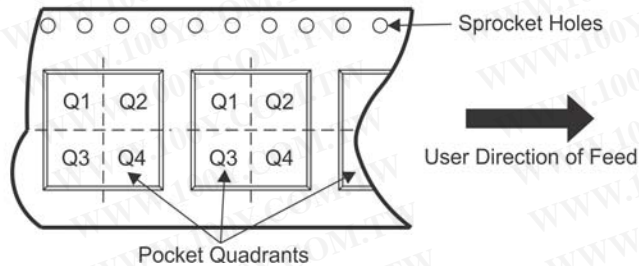
TAPE AND REEL INFORMATION

QUADRANT ASSIGNMENTS FOR PIN 1 ORIENTATION IN TAPE

*All dimensions are nominal

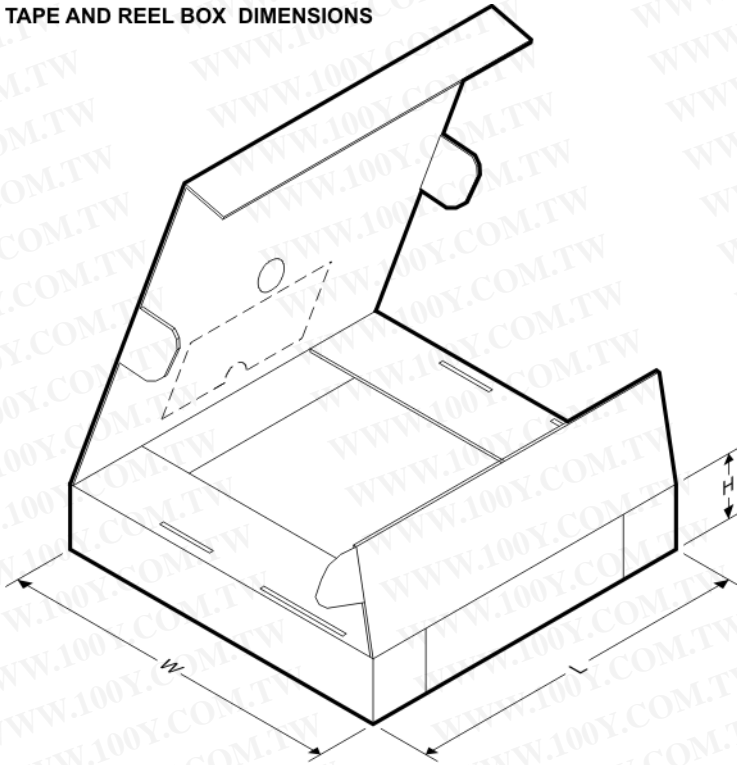
Device	Package Type	Package Drawing	Pins	SPQ	Reel Diameter (mm)	Reel Width W1 (mm)	A0 (mm)	B0 (mm)	K0 (mm)	P1 (mm)	W (mm)	Pin1 Quadrant
LMP7715MF	SOT-23	DBV	5	1000	178.0	8.4	3.2	3.2	1.4	4.0	8.0	Q3
LMP7715MF/NOPB	SOT-23	DBV	5	1000	178.0	8.4	3.2	3.2	1.4	4.0	8.0	Q3
LMP7715MFE/NOPB	SOT-23	DBV	5	250	178.0	8.4	3.2	3.2	1.4	4.0	8.0	Q3
LMP7715MFX	SOT-23	DBV	5	3000	178.0	8.4	3.2	3.2	1.4	4.0	8.0	Q3
LMP7715MFX/NOPB	SOT-23	DBV	5	3000	178.0	8.4	3.2	3.2	1.4	4.0	8.0	Q3
LMP7716MM	VSSOP	DGK	8	1000	178.0	12.4	5.3	3.4	1.4	8.0	12.0	Q1
LMP7716MM/NOPB	VSSOP	DGK	8	1000	178.0	12.4	5.3	3.4	1.4	8.0	12.0	Q1
LMP7716MME/NOPB	VSSOP	DGK	8	250	178.0	12.4	5.3	3.4	1.4	8.0	12.0	Q1
LMP7716MMX	VSSOP	DGK	8	3500	330.0	12.4	5.3	3.4	1.4	8.0	12.0	Q1
LMP7716MMX/NOPB	VSSOP	DGK	8	3500	330.0	12.4	5.3	3.4	1.4	8.0	12.0	Q1
LMP7716QMM/NOPB	VSSOP	DGK	8	1000	178.0	12.4	5.3	3.4	1.4	8.0	12.0	Q1
LMP7716QMME/NOPB	VSSOP	DGK	8	250	178.0	12.4	5.3	3.4	1.4	8.0	12.0	Q1
LMP7716QMMX/NOPB	VSSOP	DGK	8	3500	330.0	12.4	5.3	3.4	1.4	8.0	12.0	Q1

TAPE AND REEL BOX DIMENSIONS

*All dimensions are nominal

Device	Package Type	Package Drawing	Pins	SPQ	Length (mm)	Width (mm)	Height (mm)
LMP7715MF	SOT-23	DBV	5	1000	210.0	185.0	35.0
LMP7715MF/NOPB	SOT-23	DBV	5	1000	210.0	185.0	35.0
LMP7715MFE/NOPB	SOT-23	DBV	5	250	210.0	185.0	35.0
LMP7715MFX	SOT-23	DBV	5	3000	210.0	185.0	35.0
LMP7715MFX/NOPB	SOT-23	DBV	5	3000	210.0	185.0	35.0
LMP7716MM	VSSOP	DGK	8	1000	210.0	185.0	35.0
LMP7716MM/NOPB	VSSOP	DGK	8	1000	210.0	185.0	35.0
LMP7716MME/NOPB	VSSOP	DGK	8	250	210.0	185.0	35.0
LMP7716MMX	VSSOP	DGK	8	3500	367.0	367.0	35.0
LMP7716MMX/NOPB	VSSOP	DGK	8	3500	367.0	367.0	35.0
LMP7716QMM/NOPB	VSSOP	DGK	8	1000	210.0	185.0	35.0
LMP7716QMME/NOPB	VSSOP	DGK	8	250	210.0	185.0	35.0
LMP7716QMMX/NOPB	VSSOP	DGK	8	3500	367.0	367.0	35.0

DBV (R-PDSO-G5)

PLASTIC SMALL-OUTLINE PACKAGE

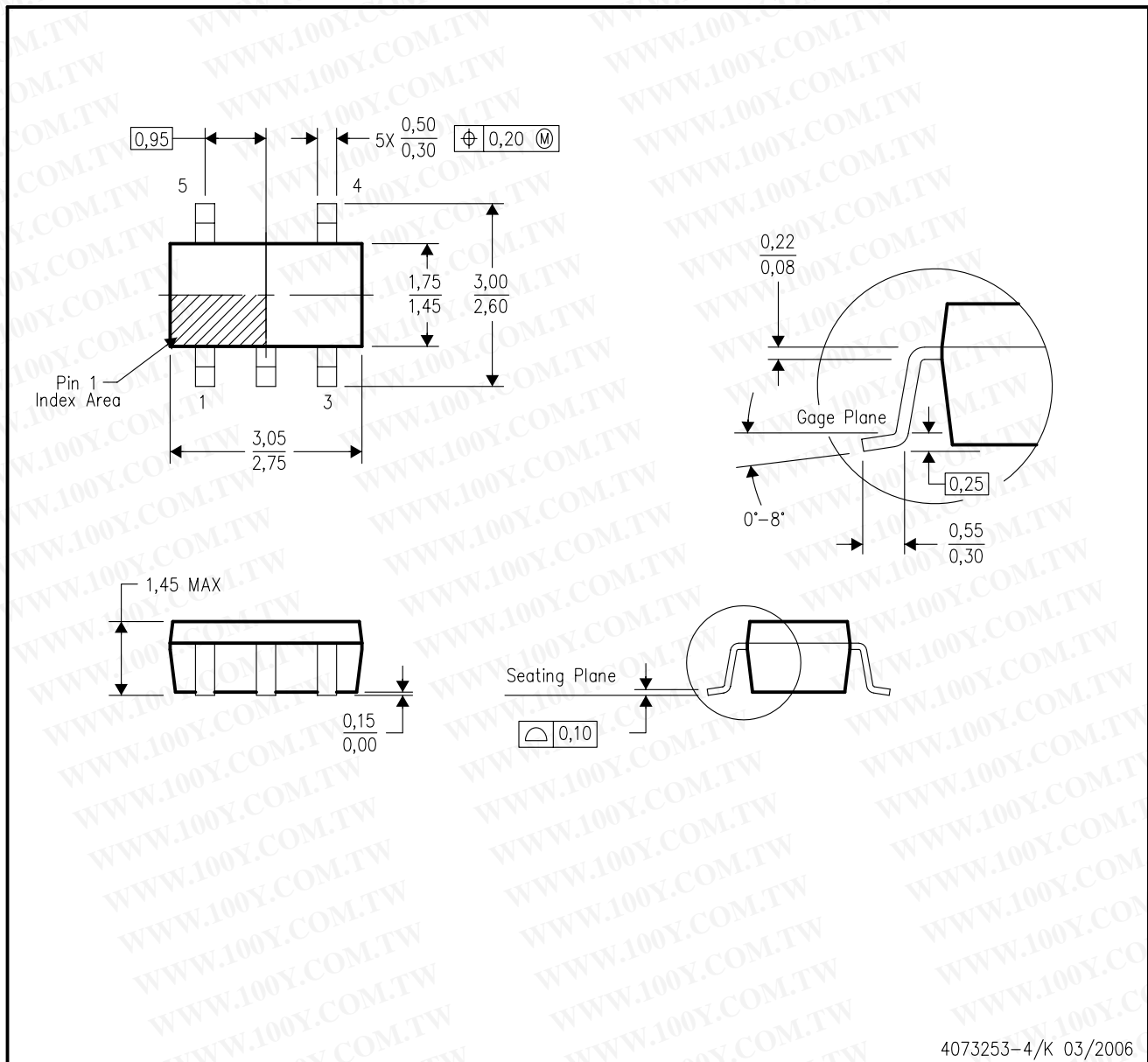

- NOTES:
- All linear dimensions are in millimeters.
 - This drawing is subject to change without notice.
 - Body dimensions do not include mold flash or protrusion. Mold flash and protrusion shall not exceed 0.15 per side.
 - Falls within JEDEC MO-178 Variation AA.

DBV (R-PDSO-G5)

PLASTIC SMALL OUTLINE

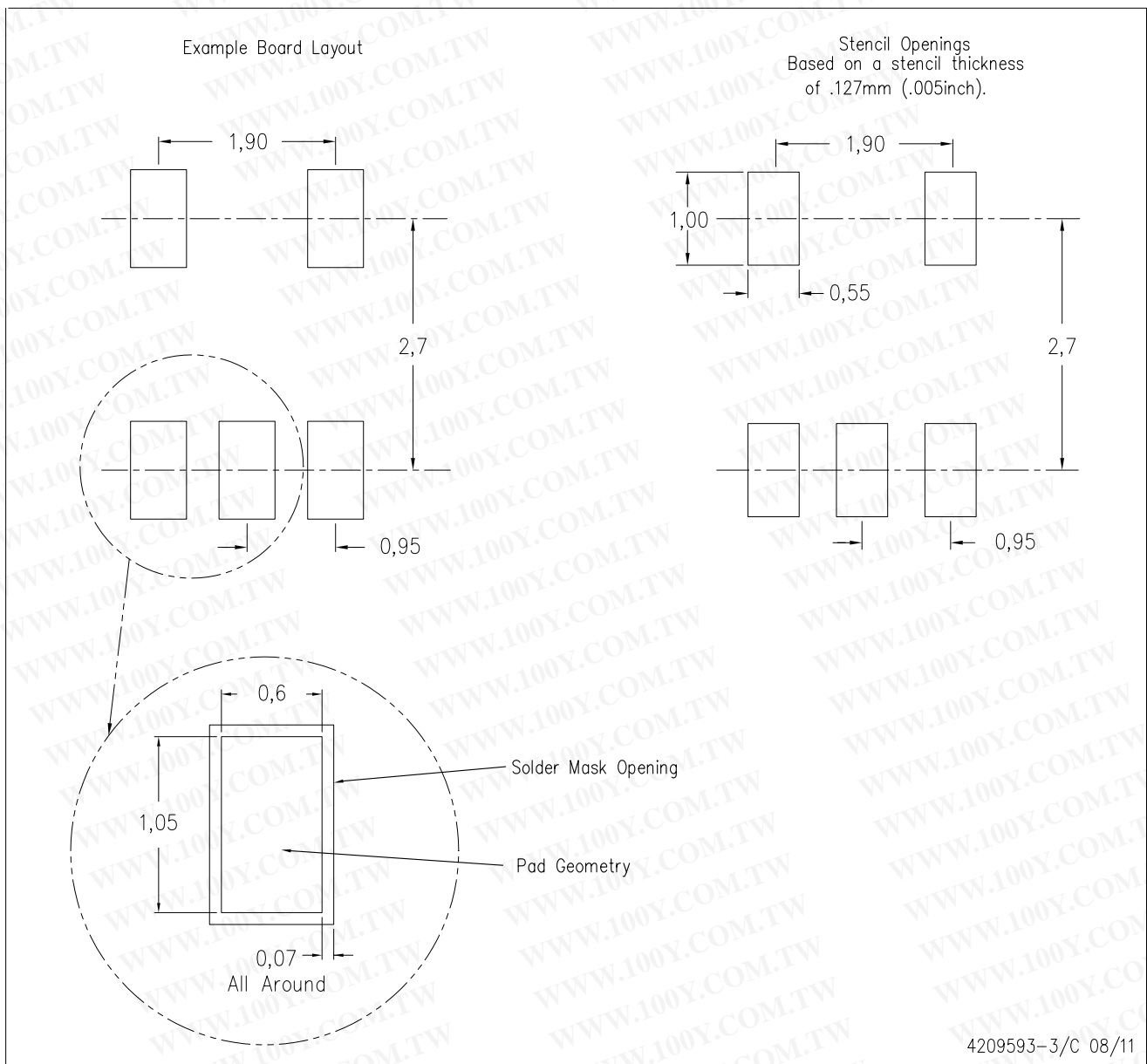

4209593-3/C 08/11

- NOTES:
- A. All linear dimensions are in millimeters.
 - B. This drawing is subject to change without notice.
 - C. Customers should place a note on the circuit board fabrication drawing not to alter the center solder mask defined pad.
 - D. Publication IPC-7351 is recommended for alternate designs.
 - E. Laser cutting apertures with trapezoidal walls and also rounding corners will offer better paste release. Customers should contact their board assembly site for stencil design recommendations. Example stencil design based on a 50% volumetric metal load solder paste. Refer to IPC-7525 for other stencil recommendations.

DGK (S-PDSO-G8)

PLASTIC SMALL-OUTLINE PACKAGE

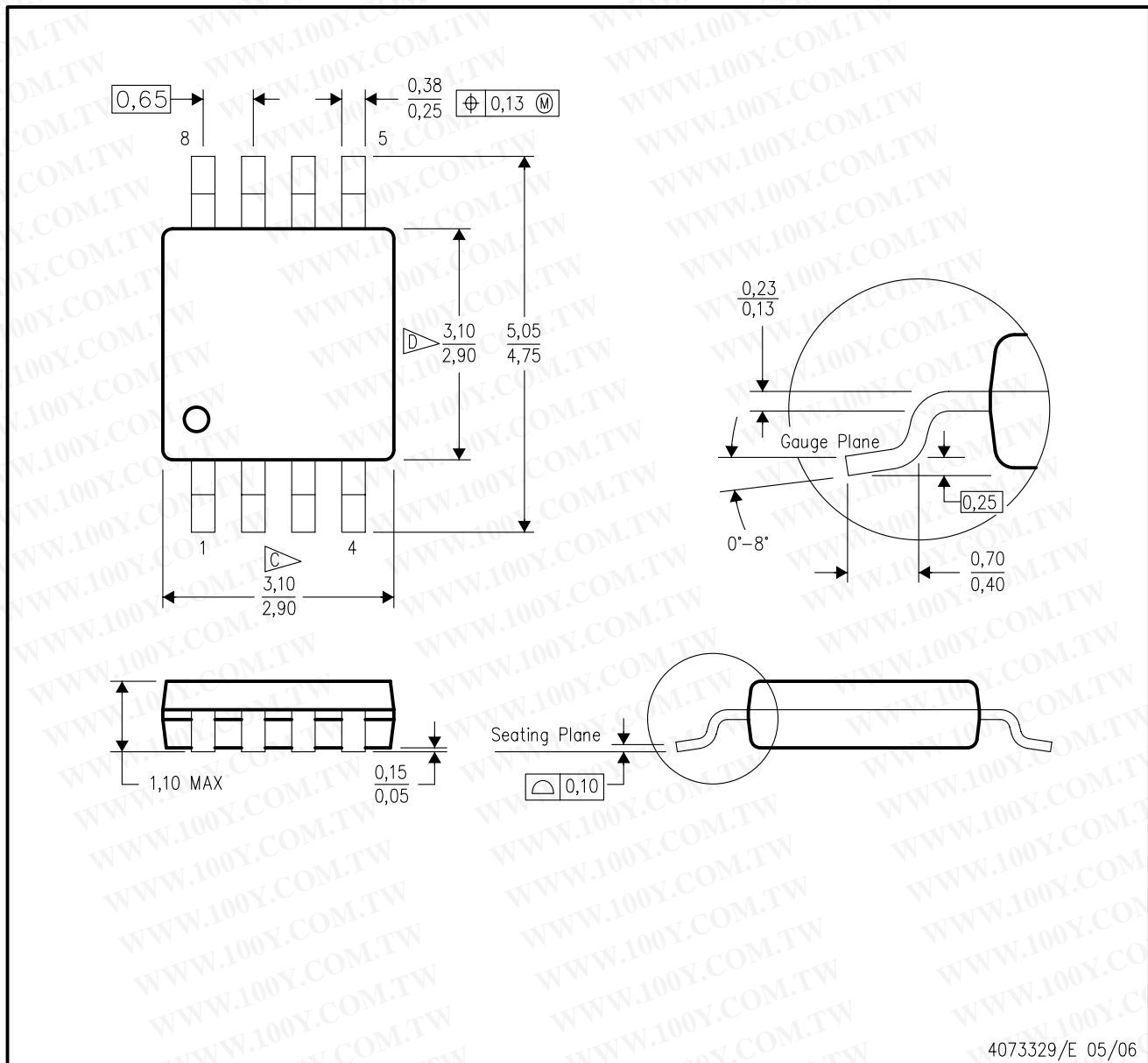

- NOTES:
- All linear dimensions are in millimeters.
 - This drawing is subject to change without notice.
 - Body length does not include mold flash, protrusions, or gate burrs. Mold flash, protrusions, or gate burrs shall not exceed 0.15 per end.
 - Body width does not include interlead flash. Interlead flash shall not exceed 0.50 per side.
 - Falls within JEDEC MO-187 variation AA, except interlead flash.

勝特力材料 886-3-5753170
勝特力电子(上海) 86-21-34970699
勝特力电子(深圳) 86-755-83298787
Http://www.100y.com.tw

IMPORTANT NOTICE

Texas Instruments Incorporated and its subsidiaries (TI) reserve the right to make corrections, enhancements, improvements and other changes to its semiconductor products and services per JESD46, latest issue, and to discontinue any product or service per JESD48, latest issue. Buyers should obtain the latest relevant information before placing orders and should verify that such information is current and complete. All semiconductor products (also referred to herein as "components") are sold subject to TI's terms and conditions of sale supplied at the time of order acknowledgment.

TI warrants performance of its components to the specifications applicable at the time of sale, in accordance with the warranty in TI's terms and conditions of sale of semiconductor products. Testing and other quality control techniques are used to the extent TI deems necessary to support this warranty. Except where mandated by applicable law, testing of all parameters of each component is not necessarily performed.

TI assumes no liability for applications assistance or the design of Buyers' products. Buyers are responsible for their products and applications using TI components. To minimize the risks associated with Buyers' products and applications, Buyers should provide adequate design and operating safeguards.

TI does not warrant or represent that any license, either express or implied, is granted under any patent right, copyright, mask work right, or other intellectual property right relating to any combination, machine, or process in which TI components or services are used. Information published by TI regarding third-party products or services does not constitute a license to use such products or services or a warranty or endorsement thereof. Use of such information may require a license from a third party under the patents or other intellectual property of the third party, or a license from TI under the patents or other intellectual property of TI.

Reproduction of significant portions of TI information in TI data books or data sheets is permissible only if reproduction is without alteration and is accompanied by all associated warranties, conditions, limitations, and notices. TI is not responsible or liable for such altered documentation. Information of third parties may be subject to additional restrictions.

Resale of TI components or services with statements different from or beyond the parameters stated by TI for that component or service voids all express and any implied warranties for the associated TI component or service and is an unfair and deceptive business practice. TI is not responsible or liable for any such statements.

Buyer acknowledges and agrees that it is solely responsible for compliance with all legal, regulatory and safety-related requirements concerning its products, and any use of TI components in its applications, notwithstanding any applications-related information or support that may be provided by TI. Buyer represents and agrees that it has all the necessary expertise to create and implement safeguards which anticipate dangerous consequences of failures, monitor failures and their consequences, lessen the likelihood of failures that might cause harm and take appropriate remedial actions. Buyer will fully indemnify TI and its representatives against any damages arising out of the use of any TI components in safety-critical applications.

In some cases, TI components may be promoted specifically to facilitate safety-related applications. With such components, TI's goal is to help enable customers to design and create their own end-product solutions that meet applicable functional safety standards and requirements. Nonetheless, such components are subject to these terms.

No TI components are authorized for use in FDA Class III (or similar life-critical medical equipment) unless authorized officers of the parties have executed a special agreement specifically governing such use.

Only those TI components which TI has specifically designated as military grade or "enhanced plastic" are designed and intended for use in military/aerospace applications or environments. Buyer acknowledges and agrees that any military or aerospace use of TI components which have **not** been so designated is solely at the Buyer's risk, and that Buyer is solely responsible for compliance with all legal and regulatory requirements in connection with such use.

TI has specifically designated certain components as meeting ISO/TS16949 requirements, mainly for automotive use. In any case of use of non-designated products, TI will not be responsible for any failure to meet ISO/TS16949.

Products

Audio	www.ti.com/audio
Amplifiers	amplifier.ti.com
Data Converters	dataconverter.ti.com
DLP® Products	www.dlp.com
DSP	dsp.ti.com
Clocks and Timers	www.ti.com/clocks
Interface	interface.ti.com
Logic	logic.ti.com
Power Mgmt	power.ti.com
Microcontrollers	microcontroller.ti.com
RFID	www.ti-rfid.com
OMAP Applications Processors	www.ti.com/omap
Wireless Connectivity	www.ti.com/wirelessconnectivity

Applications

Automotive and Transportation	www.ti.com/automotive
Communications and Telecom	www.ti.com/communications
Computers and Peripherals	www.ti.com/computers
Consumer Electronics	www.ti.com/consumer-apps
Energy and Lighting	www.ti.com/energy
Industrial	www.ti.com/industrial
Medical	www.ti.com/medical
Security	www.ti.com/security
Space, Avionics and Defense	www.ti.com/space-avionics-defense
Video and Imaging	www.ti.com/video

TI E2E Community

e2e.ti.com

Mailing Address: Texas Instruments, Post Office Box 655303, Dallas, Texas 75265
Copyright © 2013, Texas Instruments Incorporated