

LMV7291 Single 1.8V Low Power Comparator with Rail-to-Rail Input

Check for Samples: [LMV7291](#)

FEATURES

- ($V_S = 1.8V$, $T_A = 25^\circ C$, Typical Values unless Specified)
- Single Supply
- Ultra Low Supply Current $9\mu A$ per Channel
- Low Input Bias Current $10nA$
- Low Input Offset Current $200pA$
- Low ensured $V_{OS} 4mV$
- Propagation Delay $880ns$ ($20mV$ Overdrive)
- Input Common Mode Voltage Range $0.1V$ beyond Rails

APPLICATIONS

- Mobile Communications
- Laptops and PDA's
- Battery Powered Electronics
- General Purpose Low Voltage Applications

Typical Circuit

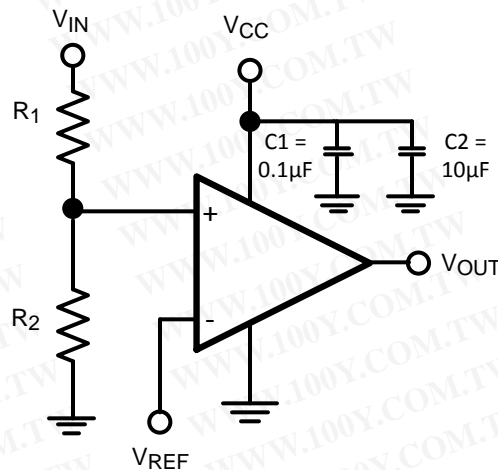

Figure 1. Threshold Detector

DESCRIPTION

The LMV7291 is a rail-to-rail input low power comparator, characterized at supply voltage $1.8V$, $2.7V$ and $5.0V$. It consumes only $9\mu A$ supply current per channel while achieving a $800ns$ propagation delay.

The LMV7291 is available in SC70 package. With this tiny package, the PC board area can be significantly reduced. It is ideal for low voltage, low power and space critical designs.

The LMV7291 features a push-pull output stage which allows operation with minimum power consumption when driving a load.

The LMV7291 is built with Texas Instruments' advance submicron silicon-gate BiCMOS process. It has bipolar inputs for improved noise performance and CMOS outputs for rail-to-rail output swing.



These devices have limited built-in ESD protection. The leads should be shorted together or the device placed in conductive foam during storage or handling to prevent electrostatic damage to the MOS gates.



Please be aware that an important notice concerning availability, standard warranty, and use in critical applications of Texas Instruments semiconductor products and disclaimers thereto appears at the end of this data sheet.

All trademarks are the property of their respective owners.

Absolute Maximum Ratings ⁽¹⁾⁽²⁾

ESD Tolerance	2KV ⁽³⁾
	200V ⁽⁴⁾
V _{IN} Differential	±Supply Voltage
Supply Voltage (V ⁺ - V ⁻)	5.5V
Voltage at Input/Output pins	V ⁺ +0.1V, V ⁻ -0.1V
Soldering Information	
Infrared or Convection (20 sec.)	235°C
Wave Soldering (10 sec.)	260°C
Storage Temperature Range	-65°C to +150°C
Junction Temperature ⁽⁵⁾	+150°C

- (1) Absolute Maximum Ratings indicate limits beyond which damage to the device may occur. Operating Ratings indicate conditions for which the device is intended to be functional, but specific performance is not ensured. For ensured specifications and the test conditions, see the Electrical Characteristics.
- (2) If Military/Aerospace specified devices are required, please contact the Texas Instruments Sales Office/ Distributors for availability and specifications.
- (3) Human body model, 1.5kΩ in series with 100pF.
- (4) Machine Model, 0Ω in series with 200pF.
- (5) Typical values represent the most likely parametric norm.

Operating Ratings ⁽¹⁾

Operating Temperature Range ⁽²⁾	-40°C to +85°C
Package Thermal Resistance ⁽²⁾	
SC70	265°C/W

- (1) Absolute Maximum Ratings indicate limits beyond which damage to the device may occur. Operating Ratings indicate conditions for which the device is intended to be functional, but specific performance is not ensured. For ensured specifications and the test conditions, see the Electrical Characteristics.
- (2) The maximum power dissipation is a function of T_{J(MAX)}, θ_{JA}, and T_A. The maximum allowable power dissipation at any ambient temperature is P_D = (T_{J(MAX)} - T_A)/θ_{JA}. All numbers apply for packages soldered directly into a PC board.

1.8V Electrical Characteristics

Unless otherwise specified, all limits ensured for $T_J = 25^\circ\text{C}$, $V^+ = 1.8\text{V}$, $V^- = 0\text{V}$. **Boldface** limits apply at the temperature extremes. ⁽¹⁾

Symbol	Parameter	Condition	Min ⁽²⁾	Typ ⁽³⁾	Max ⁽²⁾	Units
V_{OS}	Input Offset Voltage			0.3	4 6	mV
TC V_{OS}	Input Offset Temperature Drift	$V_{CM} = 0.9\text{V}$ ⁽⁴⁾		10		$\mu\text{V}/\text{C}$
I_B	Input Bias Current			10		nA
I_{OS}	Input Offset Current			200		pA
I_S	Supply Current	LMV7291		9	12 14	μA
I_{SC}	Output Short Circuit Current	Sourcing, $V_O = 0.9\text{V}$	3.5	6		mA
		Sinking, $V_O = 0.9\text{V}$	4	6		
V_{OH}	Output Voltage High	$I_O = 0.5\text{mA}$	1.7	1.74		V
		$I_O = 1.5\text{mA}$	1.58	1.63		
V_{OL}	Output Voltage Low	$I_O = -0.5\text{mA}$		52	70	mV
		$I_O = -1.5\text{mA}$		166	220	
V_{CM}	Input Common Mode Voltage Range	CMRR > 45 dB			1.9	V
			-0.1			V
CMRR	Common Mode Rejection Ratio	$0 < V_{CM} < 1.8\text{V}$	47	78		dB
PSRR	Power Supply Rejection Ratio	$V^+ = 1.8\text{V}$ to 5V	55	80		dB
$I_{LEAKAGE}$	Output Leakage Current	$V_O = 1.8\text{V}$		2		pA

- (1) Electrical Table values apply only for factory testing conditions at the temperature indicated. Factory testing conditions result in very limited self-heating of the device such that $T_J = T_A$. No ensured specification of parametric performance is indicated in the electrical tables under conditions of internal self heating where $T_J > T_A$. Absolute Maximum Ratings indicate junction temperature limits beyond which the device may be permanently degraded, either mechanically or electrically.
- (2) All limits are specified by testing or statistical analysis.
- (3) Typical values represent the most likely parametric norm.
- (4) Offset Voltage average drift determined by dividing the change in V_{OS} at temperature extremes into the total temperature change.

1.8V AC Electrical Characteristics

Unless otherwise specified, all limits ensured for $T_J = 25^\circ\text{C}$, $V^+ = 1.8\text{V}$, $V^- = 0\text{V}$, $V_{CM} = 0.5\text{V}$, $V_O = V^+/2$ and $R_L > 1\text{M}\Omega$ to V^- . **Boldface** limits apply at the temperature extremes. ⁽¹⁾

Symbol	Parameter	Condition	Min ⁽²⁾	Typ ⁽³⁾	Max ⁽²⁾	Units
t_{PHL}	Propagation Delay (High to Low)	Input Overdrive = 20mV Load = 50pF//5k Ω		880		ns
		Input Overdrive = 50mV Load = 50pF//5k Ω		570		ns
t_{PLH}	Propagation Delay (Low to High)	Input Overdrive = 20mV Load = 50pF//5k Ω		1100		ns
		Input Overdrive = 50mV Load = 50pF//5k Ω		800		ns

- (1) Electrical Table values apply only for factory testing conditions at the temperature indicated. Factory testing conditions result in very limited self-heating of the device such that $T_J = T_A$. No ensured specification of parametric performance is indicated in the electrical tables under conditions of internal self heating where $T_J > T_A$. Absolute Maximum Ratings indicate junction temperature limits beyond which the device may be permanently degraded, either mechanically or electrically.
- (2) All limits are specified by testing or statistical analysis.
- (3) Typical values represent the most likely parametric norm.

2.7V Electrical Characteristics

Unless otherwise specified, all limits ensured for $T_J = 25^\circ\text{C}$, $V^+ = 2.7\text{V}$, $V^- = 0\text{V}$. **Boldface** limits apply at the temperature extremes. ⁽¹⁾

Symbol	Parameter	Conditions	Min ⁽²⁾	Typ ⁽³⁾	Max ⁽²⁾	Units
V_{OS}	Input Offset Voltage			0.3	4 6	mV
$TC\ V_{OS}$	Input Offset Temperature Drift	$V_{CM} = 1.35\text{V}$ ⁽⁴⁾		10		$\mu\text{V}/\text{C}$
I_B	Input Bias Current			10		nA
I_{OS}	Input offset Current			200		pA
I_S	Supply Current	LMV7291		9	13 15	μA
I_{SC}	Output Short Circuit Current	Sourcing, $V_O = 1.35\text{V}$	12	15		mA
		Sinking, $V_O = 1.35\text{V}$	12	15		
V_{OH}	Output Voltage High	$I_O = 0.5\text{mA}$	2.63	2.66		V
		$I_O = 2.0\text{mA}$	2.48	2.55		
V_{OL}	Output Voltage Low	$I_O = -0.5\text{mA}$		50	70	mV
		$I_O = -2\text{mA}$		155	220	
V_{CM}	Input Common Voltage Range	CMRR > 45dB			2.8	V
			-0.1			V
CMRR	Common Mode Rejection Ratio	$0 < V_{CM} < 2.7\text{V}$	47	78		dB
PSRR	Power Supply Rejection Ratio	$V^+ = 1.8\text{V}$ to 5V	55	80		dB
$I_{LEAKAGE}$	Output Leakage Current	$V_O = 2.7\text{V}$		2		pA

- (1) Electrical Table values apply only for factory testing conditions at the temperature indicated. Factory testing conditions result in very limited self-heating of the device such that $T_J = T_A$. No ensured specification of parametric performance is indicated in the electrical tables under conditions of internal self heating where $T_J > T_A$. Absolute Maximum Ratings indicate junction temperature limits beyond which the device may be permanently degraded, either mechanically or electrically.
- (2) All limits are specified by testing or statistical analysis.
- (3) Typical values represent the most likely parametric norm.
- (4) Offset Voltage average drift determined by dividing the change in V_{OS} at temperature extremes into the total temperature change.

2.7V AC Electrical Characteristics

Unless otherwise specified, all limits ensured for $T_J = 25^\circ\text{C}$, $V^+ = 2.7\text{V}$, $V^- = 0\text{V}$, $V_{CM} = 0.5\text{V}$, $V_O = V^+/2$ and $R_L > 1\text{M}\Omega$ to V^- . **Boldface** limits apply at the temperature extremes. ⁽¹⁾

Symbol	Parameter	Condition	Min ⁽²⁾	Typ ⁽³⁾	Max ⁽²⁾	Units
t_{PHL}	Propagation Delay (High to Low)	Input Overdrive = 20mV Load = 50pF//5k Ω		1200		ns
		Input Overdrive = 50mV Load = 50pF//5k Ω		810		ns
t_{PLH}	Propagation Delay (Low to High)	Input Overdrive = 20mV Load = 50pF//5k Ω		1300		ns
		Input Overdrive = 50mV Load = 50pF//5k Ω		860		ns

- (1) Electrical Table values apply only for factory testing conditions at the temperature indicated. Factory testing conditions result in very limited self-heating of the device such that $T_J = T_A$. No ensured specification of parametric performance is indicated in the electrical tables under conditions of internal self heating where $T_J > T_A$. Absolute Maximum Ratings indicate junction temperature limits beyond which the device may be permanently degraded, either mechanically or electrically.
- (2) All limits are specified by testing or statistical analysis.
- (3) Typical values represent the most likely parametric norm.

5V Electrical Characteristics

Unless otherwise specified, all limits ensured for $T_J = 25^\circ\text{C}$, $V^+ = 5\text{V}$, $V^- = 0\text{V}$. **Boldface** limits apply at the temperature extremes. ⁽¹⁾

Symbol	Parameter	Conditions	Min ⁽²⁾	Typ ⁽³⁾	Max ⁽²⁾	Units
V_{OS}	Input Offset Voltage			0.3	4 6	mV
$TC\ V_{OS}$	Input Offset Temperature Drift	$V_{CM} = 2.5\text{V}$ ⁽⁴⁾		10		$\mu\text{V}/\text{C}$
I_B	Input Bias Current			10		nA
I_{OS}	Input Offset Current			200		pA
I_S	Supply Current	LMV7291		10	14 16	μA
I_{SC}	Output Short Circuit Current	Sourcing, $V_O = 2.5\text{V}$	28	34		mA
		Sinking, $V_O = 2.5\text{V}$	28	34		
V_{OH}	Output Voltage High	$I_O = 0.5\text{mA}$	4.93	4.96		V
		$I_O = 4.0\text{mA}$	4.70	4.77		
V_{OL}	Output Voltage Low	$I_O = -0.5\text{mA}$		27	70	mV
		$I_O = -4.0\text{mA}$		225	300	
V_{CM}	Input Common Voltage Range	CMRR > 45dB			5.1	V
			-0.1			
CMRR	Common Mode Rejection Ratio	$0 < V_{CM} < 5.0\text{V}$	47	78		dB
PSRR	Power Supply Rejection Ratio	$V^+ = 1.8\text{V}$ to 5V	55	80		dB
$I_{LEAKAGE}$	Output Leakage Current	$V_O = 5\text{V}$		2		pA

- (1) Electrical Table values apply only for factory testing conditions at the temperature indicated. Factory testing conditions result in very limited self-heating of the device such that $T_J = T_A$. No ensured specification of parametric performance is indicated in the electrical tables under conditions of internal self heating where $T_J > T_A$. Absolute Maximum Ratings indicate junction temperature limits beyond which the device may be permanently degraded, either mechanically or electrically.
- (2) All limits are specified by testing or statistical analysis.
- (3) Typical values represent the most likely parametric norm.
- (4) Offset Voltage average drift determined by dividing the change in V_{OS} at temperature extremes into the total temperature change.

5.0V AC Electrical Characteristics

Unless otherwise specified, all limits ensured for $T_J = 25^\circ\text{C}$, $V^+ = 5.0\text{V}$, $V^- = 0\text{V}$, $V_{CM} = 0.5\text{V}$, $V_O = V^+/2$ and $R_L > 1\text{M}\Omega$ to V^- . **Boldface** limits apply at the temperature extremes. ⁽¹⁾

Symbol	Parameter	Condition	Min ⁽²⁾	Typ ⁽³⁾	Max ⁽²⁾	Units
t_{PHL}	Propagation Delay (High to Low)	Input Overdrive = 20mV Load = 50pF//5k Ω		2100		ns
		Input Overdrive = 50mV Load = 50pF//5k Ω		1380		ns
t_{PLH}	Propagation Delay (Low to High)	Input Overdrive = 20mV Load = 50pF//5k Ω		1800		ns
		Input Overdrive = 50mV Load = 50pF//5k Ω		1100		ns

- (1) Electrical Table values apply only for factory testing conditions at the temperature indicated. Factory testing conditions result in very limited self-heating of the device such that $T_J = T_A$. No ensured specification of parametric performance is indicated in the electrical tables under conditions of internal self heating where $T_J > T_A$. Absolute Maximum Ratings indicate junction temperature limits beyond which the device may be permanently degraded, either mechanically or electrically.
- (2) All limits are specified by testing or statistical analysis.
- (3) Typical values represent the most likely parametric norm.

Connection Diagram

Figure 2. 5-Pin SC70 – Top View
See Package Number DCK

Typical Performance Characteristics

($T_A = 25^\circ\text{C}$, Unless otherwise specified).

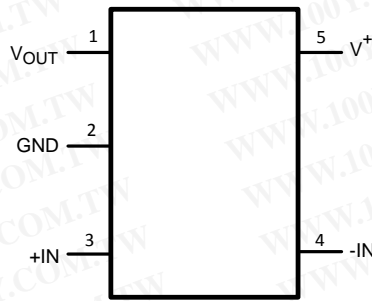
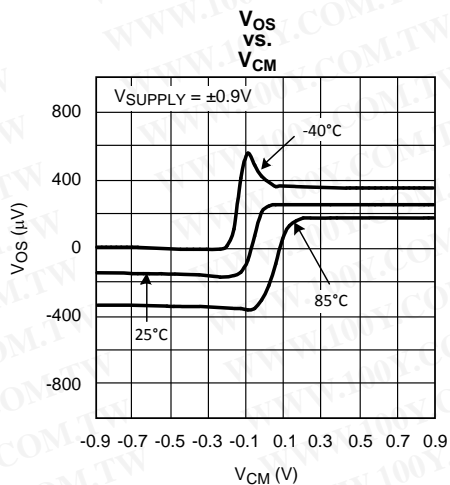

Figure 3.

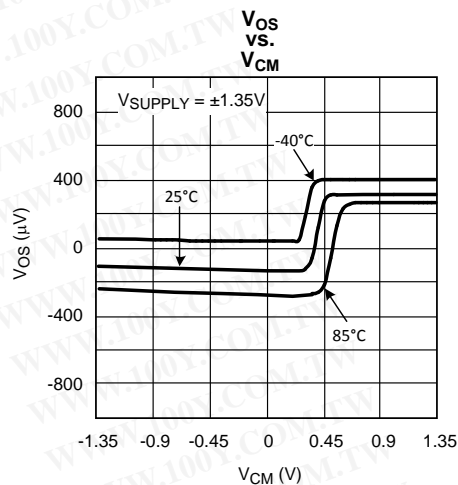

Figure 4.

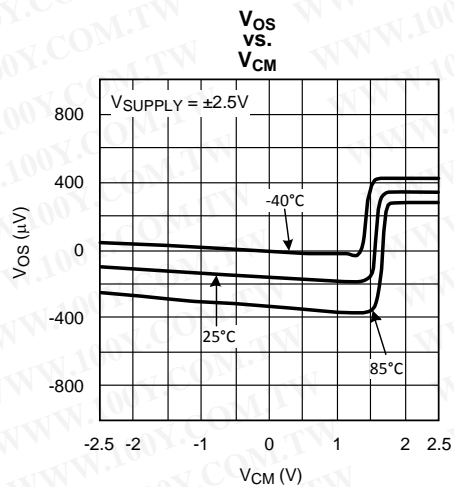

Figure 5.

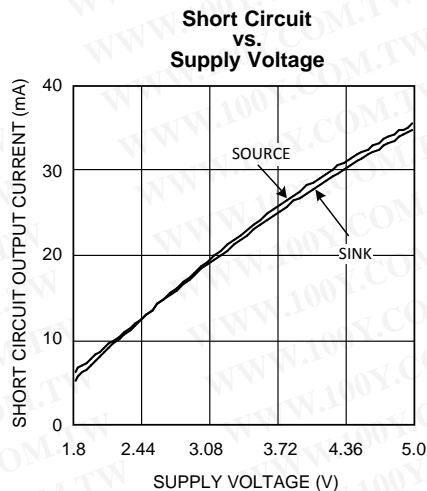

Figure 6.

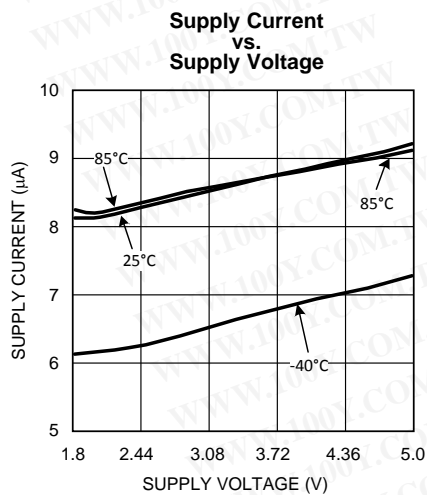

Figure 7.

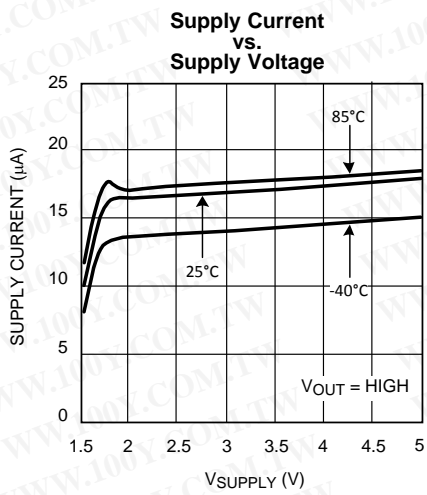

Figure 8.

Typical Performance Characteristics (continued)

($T_A = 25^\circ\text{C}$, Unless otherwise specified).

Supply Current vs. Supply Voltage

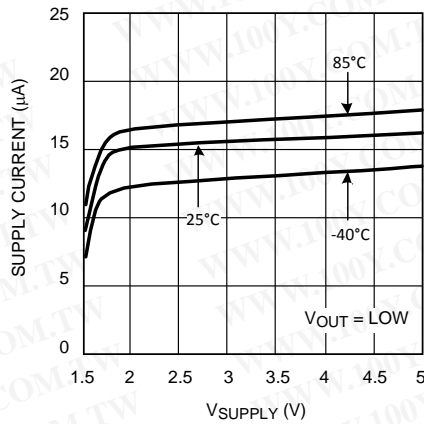

Figure 9.

Output Positive Swing vs. V_{SUPPLY}

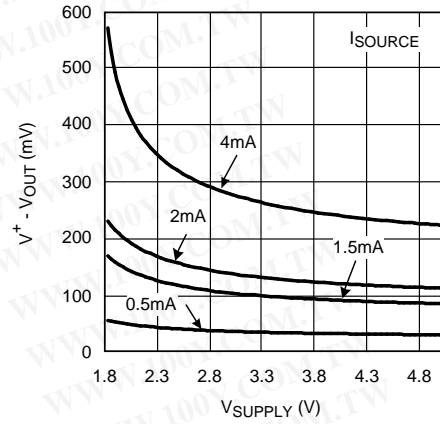

Figure 10.

Output Negative Swing vs. V_{SUPPLY}

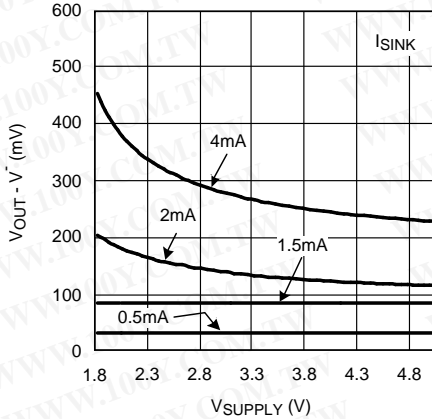

Figure 11.

Output Positive Swing vs. I_{SOURCE}

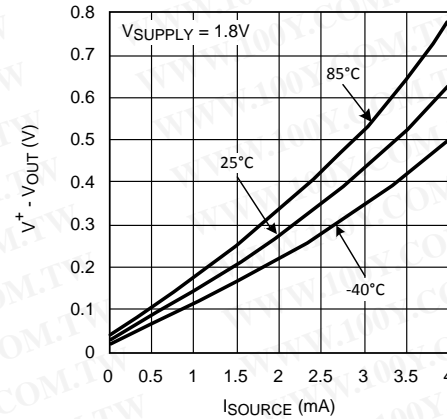

Figure 12.

Output Negative Swing vs. I_{SINK}

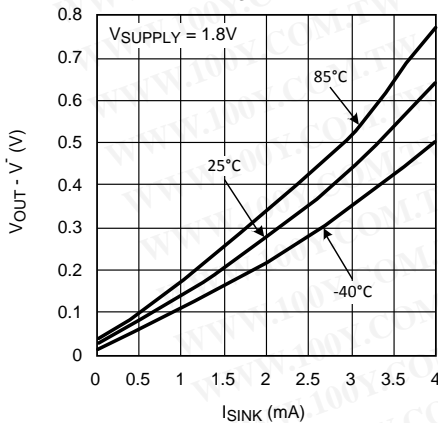

Figure 13.

Output Positive Swing vs. I_{SOURCE}

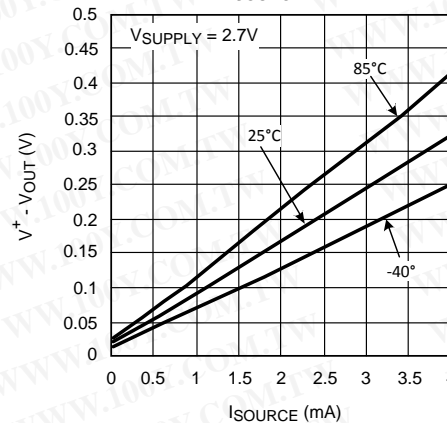

Figure 14.

Typical Performance Characteristics (continued)

($T_A = 25^\circ\text{C}$, Unless otherwise specified).

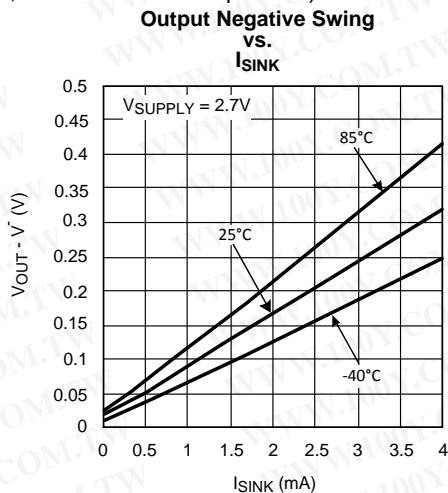

Figure 15.

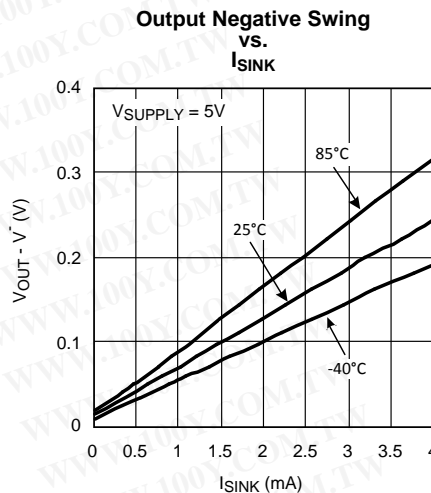

Figure 16.

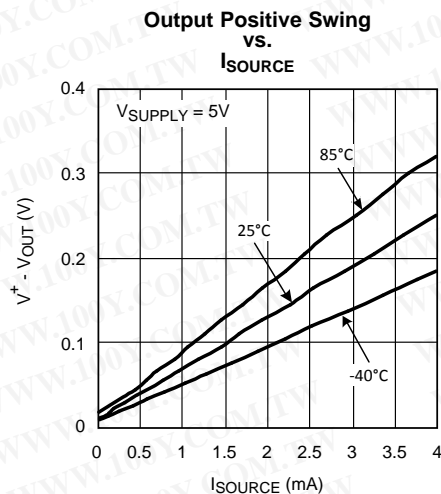

Figure 17.

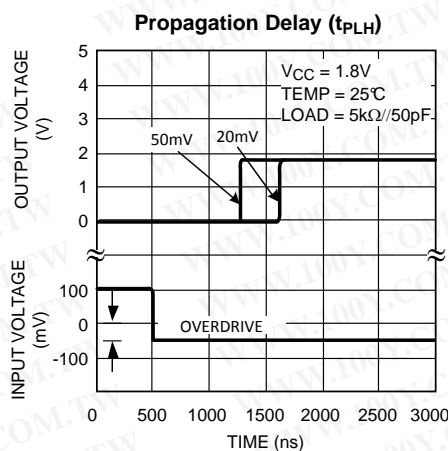

Figure 18.

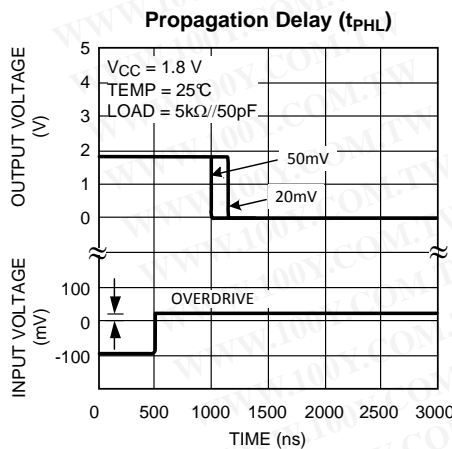

Figure 19.

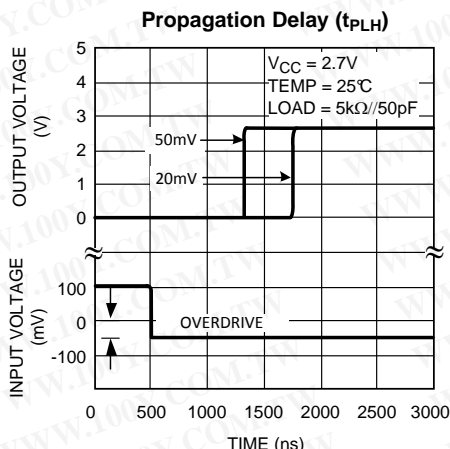

Figure 20.

Typical Performance Characteristics (continued)

($T_A = 25^\circ\text{C}$, Unless otherwise specified).

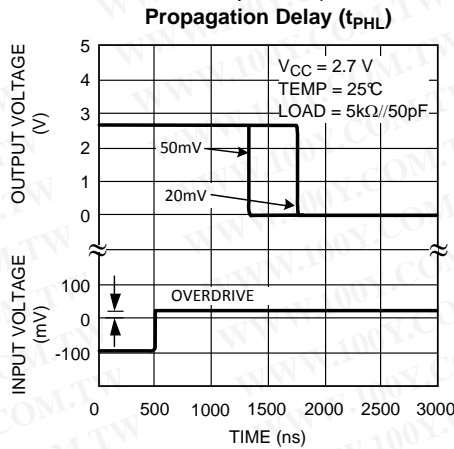

Figure 21.

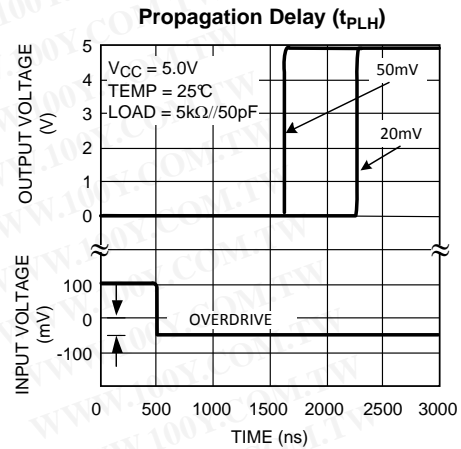

Figure 22.

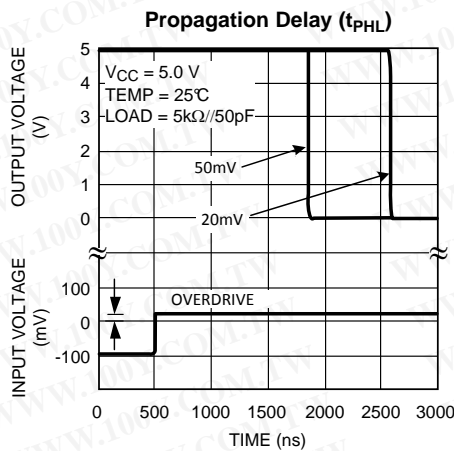

Figure 23.

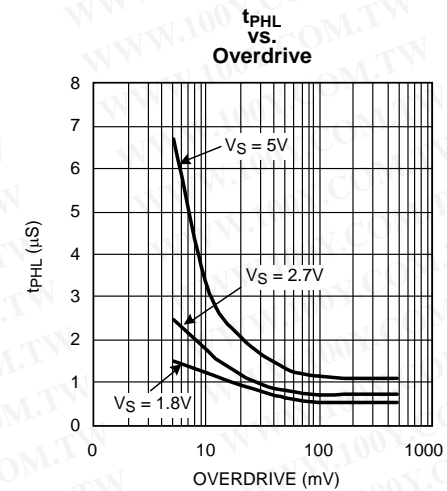

Figure 24.

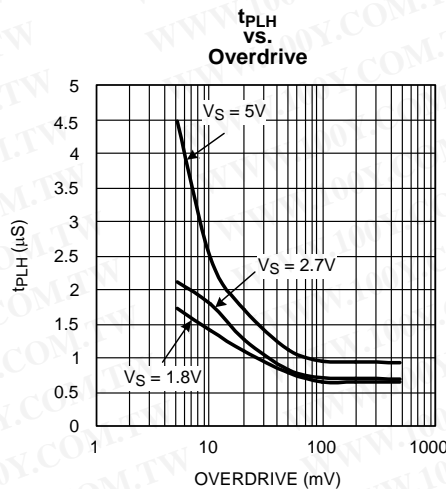

Figure 25.

APPLICATION NOTES

BASIC COMPARATOR

A comparator is often used to convert an analog signal to a digital signal. As shown in [Figure 26](#), the comparator compares an input voltage (V_{IN}) to a reference voltage (V_{REF}). If V_{IN} is less than V_{REF} , the output (V_O) is low. However, if V_{IN} is greater than V_{REF} , the output voltage (V_O) is high.

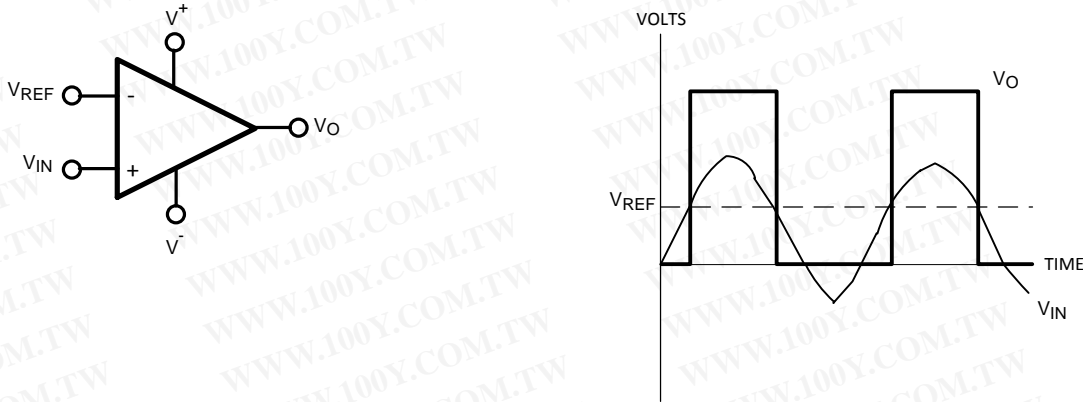

Figure 26. LMV7291 Basic Comparator

RAIL-TO-RAIL INPUT STAGE

The LMV7291 has an input common mode voltage range (V_{CM}) of $-0.1V$ below the V^- to $0.1V$ above V^+ . This is achieved by using paralleled PNP and NPN differential input pairs. When the V_{CM} is near V^+ , the NPN pair is on and the PNP pair is off. When the V_{CM} is near V^- , the NPN pair is off and the PNP pair is on. The crossover point between the NPN and PNP input stages is around $950mV$ from V^+ . Since each input stage has its own offset voltage (V_{OS}), the V_{OS} of the comparator becomes a function of the V_{CM} . See [Figure 3](#), [Figure 4](#), and [Figure 5](#) in [Typical Performance Characteristics](#). In application design, it is recommended to keep the V_{CM} away from the crossover point to avoid problems. The wide input voltage range makes LMV7291 ideal in power supply monitoring circuits, where the comparators are used to sense signals close to gnd and power supplies.

OUTPUT STAGE

The LMV7291 has a push-pull output stage. This output stage keeps the total system power consumption to the absolute minimum. The only current consumed is the low supply current and the current going directly into the load. When output switches, both PMOS and NMOS at the output stage are on at the same time for a very short time. This allows current to flow directly between V^+ and V^- through output transistors. The result is a short spike of current (shoot-through current) drawn from the supply and glitches in the supply voltages. The glitches can spread to other parts of the board as noise. To prevent the glitches in supply lines, power supply bypass capacitors must be installed. See [CIRCUIT TECHNIQUES FOR AVOIDING OSCILLATIONS IN COMPARATOR APPLICATIONS](#) for details.

HYSTERESIS

It is a standard procedure to use hysteresis (positive feedback) around a comparator, to prevent oscillation, and to avoid excessive noise on the output because the comparator is a good amplifier of its own noise.

Inverting Comparator with Hysteresis

The inverting comparator with hysteresis requires a three resistor network that are referenced to the supply voltage V_{CC} of the comparator ([Figure 27](#)). When V_{IN} at the inverting input is less than V_A , the voltage at the non-inverting node of the comparator ($V_{IN} < V_A$), the output voltage is high (for simplicity assume V_O switches as high as V_{CC}). The three network resistors can be represented as $R_1 || R_3$ in series with R_2 . The lower input trip voltage V_{A1} is defined as

$$V_{A1} = \frac{V_{CC} R_2}{(R_1 || R_3) + R_2} \quad (1)$$

When V_{IN} is greater than V_A ($V_{IN} > V_A$), the output voltage is low and very close to ground. In this case the three network resistors can be presented as R_2/R_3 in series with R_1 . The upper trip voltage V_{A2} is defined as

$$V_{A2} = \frac{V_{CC} (R_2 || R_3)}{R_1 + (R_2 || R_3)} \quad (2)$$

The total hysteresis provided by the network is defined as

$$\Delta V_A = V_{A1} - V_{A2} \quad (3)$$

A good typical value of ΔV_A would be in the range of 5 to 50 mV. This is easily obtained by choosing R_3 as 100 to 100 times $(R_1 || R_2)$ for 5V operation, or as 300 to 30 times $(R_1 || R_2)$ for 1.8V operation.

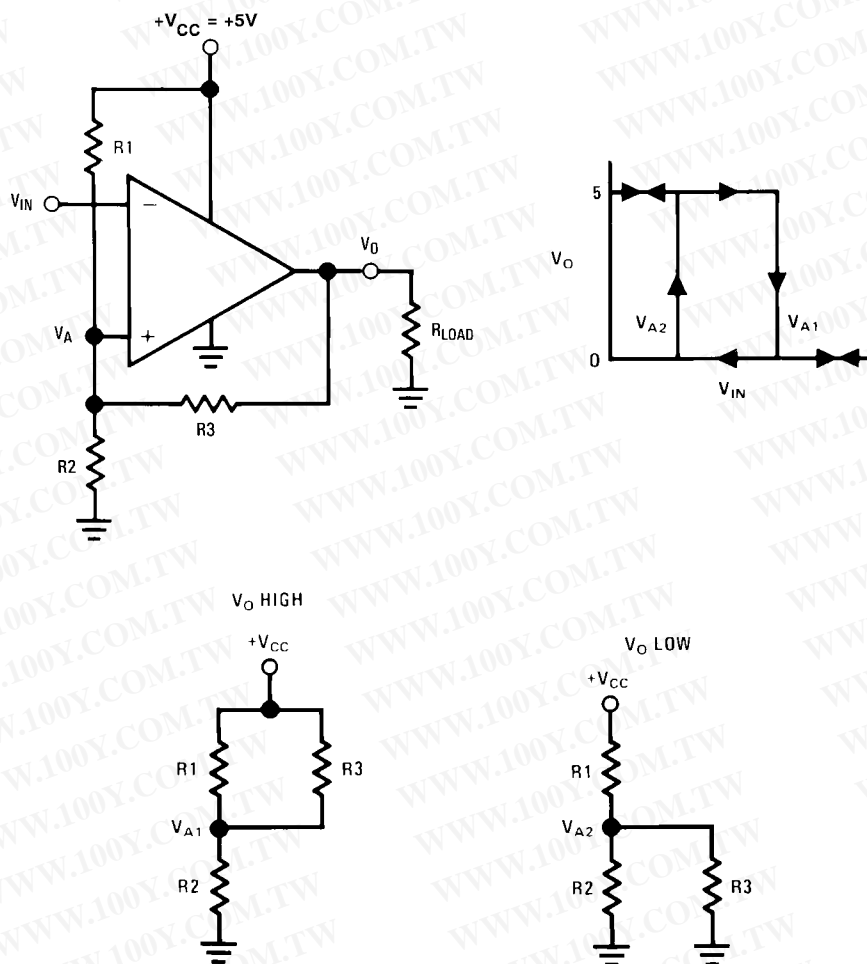

Figure 27. Inverting Comparator with Hysteresis

Non-Inverting Comparator with Hysteresis

A non-inverting comparator with hysteresis requires a two resistor network, and a voltage reference (V_{REF}) at the inverting input (Figure 28). When V_{IN} is low, the output is also low. For the output to switch from low to high, V_{IN} must rise up to V_{IN1} , where V_{IN1} is calculated by

$$V_{in1} = \frac{V_{ref} (R_1 + R_2)}{R_2} \quad (4)$$

When V_{IN} is high, the output is also high. To make the comparator switch back to its low state, V_{IN} must equal V_{REF} before V_A will again equal V_{REF} . V_{IN} can be calculated by:

$$V_{in2} = \frac{V_{ref}(R_1 + R_2) - V_{CC}R_1}{R_2} \quad (5)$$

The hysteresis of this circuit is the difference between V_{IN1} and V_{IN2} .

$$\Delta V_{IN} = V_{CC}R_1/R_2 \quad (6)$$

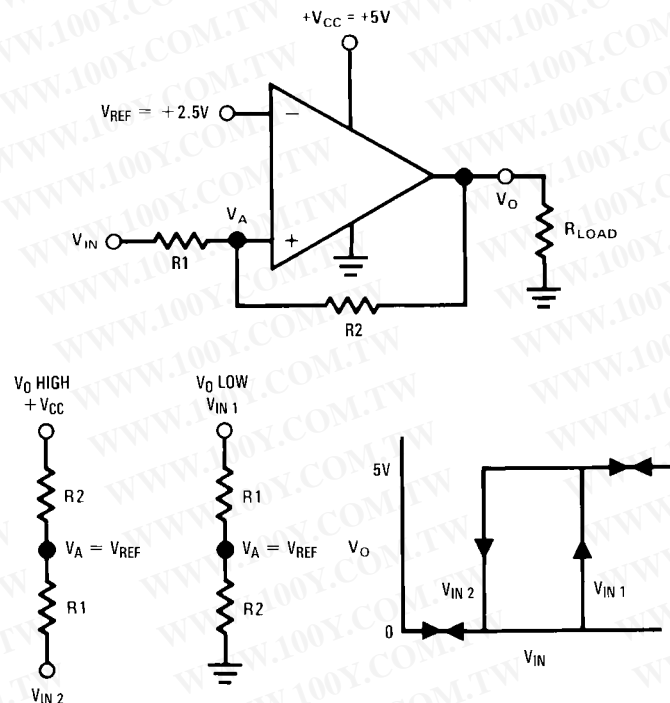

Figure 28. Non-Inverting Comparator with Hysteresis

CIRCUIT TECHNIQUES FOR AVOIDING OSCILLATIONS IN COMPARATOR APPLICATIONS

Feedback to almost any pin of a comparator can result in oscillation. In addition, when the input signal is a slow voltage ramp or sine wave, the comparator may also burst into oscillation near the crossing point. To avoid oscillation or instability, PCB layout should be engineered thoughtfully. Several precautions are recommended:

1. Power supply bypassing is critical, and will improve stability and transient response. Resistance and inductance from power supply wires and board traces increase power supply line impedance. When supply current changes, the power supply line will move due to its impedance. Large enough supply line shift will cause the comparator to mis-operate. To avoid problems, a small bypass capacitor, such as 0.1µF ceramic, should be placed immediately adjacent to the supply pins. An additional 6.8µF or greater tantalum capacitor should be placed at the point where the power supply for the comparator is introduced onto the board. These capacitors act as an energy reservoir and keep the supply impedance low. In dual supply application, a 0.1µF capacitor is recommended to be placed across V^+ and V^- pins.
2. Keep all leads short to reduce stray capacitance and lead inductance. It will also minimize any unwanted coupling from any high-level signals (such as the output). The comparators can easily oscillate if the output lead is inadvertently allowed to capacitively couple to the inputs via stray capacitance. This shows up only during the output voltage transition intervals as the comparator changes states. Try to avoid a long loop which could act as an inductor (coil).
3. It is a good practice to use an unbroken ground plane on a printed circuit board to provide all components with a low inductive ground connection. Make sure ground paths are low-impedance where heavier currents are flowing to avoid ground level shift. Preferably there should be a ground plane under the component.
4. The output trace should be routed away from inputs. The ground plane should extend between the output and inputs to act as a guard.

5. When the signal source is applied through a resistive network to one input of the comparator, it is usually advantageous to connect the other input with a resistor with the same value, for both DC and AC consideration. Input traces should be laid out symmetrically if possible.
6. All pins of any unused comparators should be tied to the negative supply.

Typical Applications

POSITIVE PEAK DETECTOR

A positive peak detect circuit is basically a comparator operated in a unity gain follower configuration, with a capacitor as a load to maintain the highest voltage. A diode is added at the output to prevent the capacitor from discharging through the output, and a $1\text{M}\Omega$ resistor added in parallel to the capacitor to provide a high impedance discharge path. When the input V_{IN} increases, the inverting input of the comparator follows it, thus charging the capacitor. When it decreases, the cap discharges through the $1\text{M}\Omega$ resistor. The decay time can be modified by changing the resistor. The output should be accessed through a follower circuit to prevent loading.

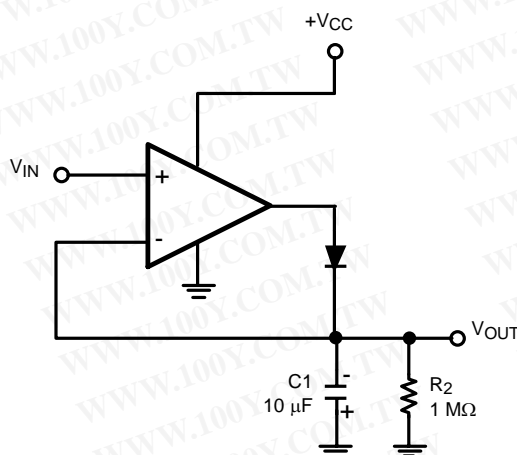

Figure 29. Positive Peak Detector

NEGATIVE PEAK DETECTOR

For the negative detector, the output transistor of the comparator acts as a low impedance current sink. Since there is no pull-up resistor, the only discharge path will be the $1\text{M}\Omega$ resistor and any load impedance used. Decay time is changed by varying the $1\text{M}\Omega$ resistor.

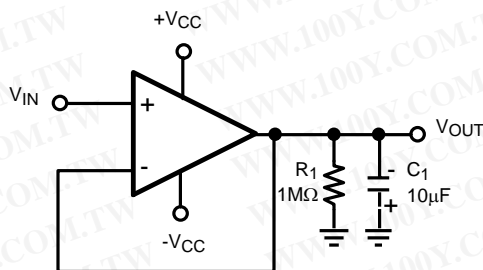

Figure 30. Negative Peak Detector

SQUARE WAVE GENERATOR

A typical application for a comparator is as a square wave oscillator. The circuit below generates a square wave whose period is set by the RC time constant of the capacitor C_1 and resistor R_4 . The maximum frequency is limited by the large signal propagation delay of the comparator, and by the capacitive loading at the output, which limits the output slew rate.

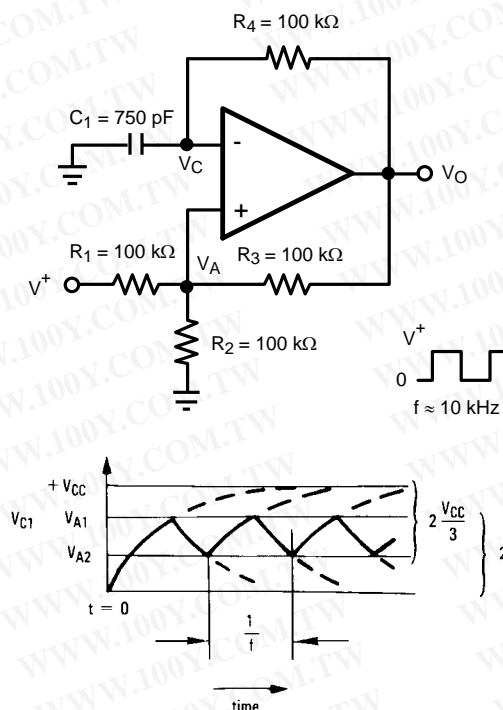

Figure 31. Squarewave Oscillator

To analyze the circuit, consider it when the output is high. That implies that the inverted input (V_C) is lower than the non-inverting input (V_A). This causes the C_1 to get charged through R_4 , and the voltage V_C increases till it is equal to the non-inverting input. The value of V_A at this point is

$$V_{A1} = \frac{V_{CC} \cdot R_2}{R_2 + R_1 \parallel R_3} \quad (7)$$

If $R_1 = R_2 = R_3$ then $V_{A1} = 2V_{CC}/3$

At this point the comparator switches pulling down the output to the negative rail. The value of V_A at this point is

$$V_{A2} = \frac{V_{CC} (R_2 \parallel R_3)}{R_1 + (R_2 \parallel R_3)} \quad (8)$$

If $R_1 = R_2 = R_3$ then $V_{A2} = V_{CC}/3$

The capacitor C_1 now discharges through R_4 , and the voltage V_C decreases till it is equal to V_{A2} , at which point the comparator switches again, bringing it back to the initial stage. The time period is equal to twice the time it takes to discharge C_1 from $2V_{CC}/3$ to $V_{CC}/3$, which is given by $R_4 C_1 \ln 2$. Hence the formula for the frequency is:

$$F = 1/(2 \cdot R_4 \cdot C_1 \cdot \ln 2)$$

REVISION HISTORY

Changes from Revision D (March 2013) to Revision E

Page

- Changed layout of National Data Sheet to TI format 15

PACKAGING INFORMATION

Orderable Device	Status (1)	Package Type	Package Drawing	Pins	Package Qty	Eco Plan (2)	Lead/Ball Finish	MSL Peak Temp (3)	Op Temp (°C)	Top-Side Markings (4)	Samples
LMV7291MG	ACTIVE	SC70	DCK	5	1000	TBD	Call TI	Call TI	-40 to 85	C36	Samples
LMV7291MG/NOPB	ACTIVE	SC70	DCK	5	1000	Green (RoHS & no Sb/Br)	CU SN	Level-1-260C-UNLIM	-40 to 85	C36	Samples
LMV7291MGX	ACTIVE	SC70	DCK	5	3000	TBD	Call TI	Call TI	-40 to 85	C36	Samples
LMV7291MGX/NOPB	ACTIVE	SC70	DCK	5	3000	Green (RoHS & no Sb/Br)	CU SN	Level-1-260C-UNLIM	-40 to 85	C36	Samples

(1) The marketing status values are defined as follows:

ACTIVE: Product device recommended for new designs.

LIFEBUY: TI has announced that the device will be discontinued, and a lifetime-buy period is in effect.

NRND: Not recommended for new designs. Device is in production to support existing customers, but TI does not recommend using this part in a new design.

PREVIEW: Device has been announced but is not in production. Samples may or may not be available.

OBSELETE: TI has discontinued the production of the device.

(2) Eco Plan - The planned eco-friendly classification: Pb-Free (RoHS), Pb-Free (RoHS Exempt), or Green (RoHS & no Sb/Br) - please check <http://www.ti.com/productcontent> for the latest availability information and additional product content details.

TBD: The Pb-Free/Green conversion plan has not been defined.

Pb-Free (RoHS): TI's terms "Lead-Free" or "Pb-Free" mean semiconductor products that are compatible with the current RoHS requirements for all 6 substances, including the requirement that lead not exceed 0.1% by weight in homogeneous materials. Where designed to be soldered at high temperatures, TI Pb-Free products are suitable for use in specified lead-free processes.

Pb-Free (RoHS Exempt): This component has a RoHS exemption for either 1) lead-based flip-chip solder bumps used between the die and package, or 2) lead-based die adhesive used between the die and leadframe. The component is otherwise considered Pb-Free (RoHS compatible) as defined above.

Green (RoHS & no Sb/Br): TI defines "Green" to mean Pb-Free (RoHS compatible), and free of Bromine (Br) and Antimony (Sb) based flame retardants (Br or Sb do not exceed 0.1% by weight in homogeneous material)

(3) MSL, Peak Temp. -- The Moisture Sensitivity Level rating according to the JEDEC industry standard classifications, and peak solder temperature.

(4) Multiple Top-Side Markings will be inside parentheses. Only one Top-Side Marking contained in parentheses and separated by a "--" will appear on a device. If a line is indented then it is a continuation of the previous line and the two combined represent the entire Top-Side Marking for that device.

Important Information and Disclaimer: The information provided on this page represents TI's knowledge and belief as of the date that it is provided. TI bases its knowledge and belief on information provided by third parties, and makes no representation or warranty as to the accuracy of such information. Efforts are underway to better integrate information from third parties. TI has taken and continues to take reasonable steps to provide representative and accurate information but may not have conducted destructive testing or chemical analysis on incoming materials and chemicals. TI and TI suppliers consider certain information to be proprietary, and thus CAS numbers and other limited information may not be available for release.

In no event shall TI's liability arising out of such information exceed the total purchase price of the TI part(s) at issue in this document sold by TI to Customer on an annual basis.

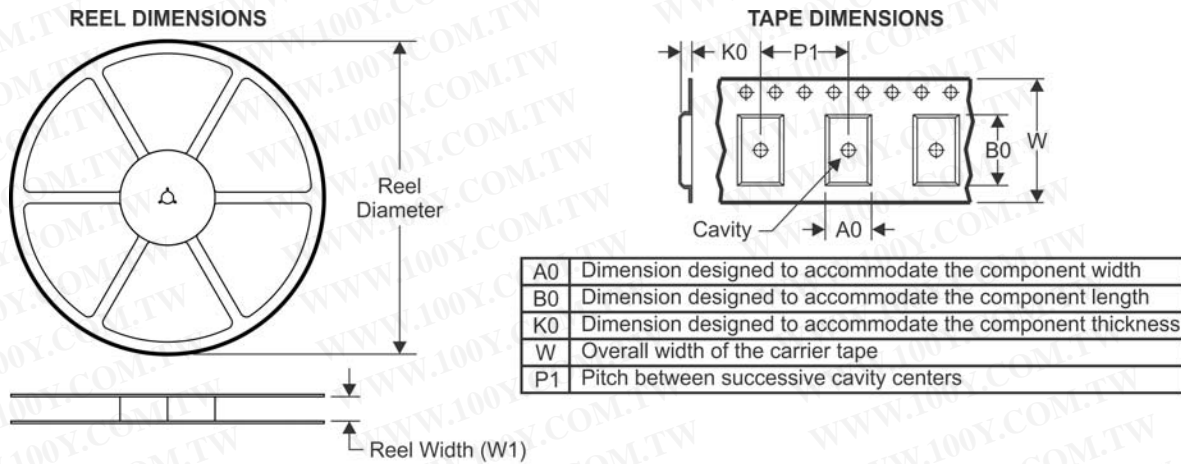
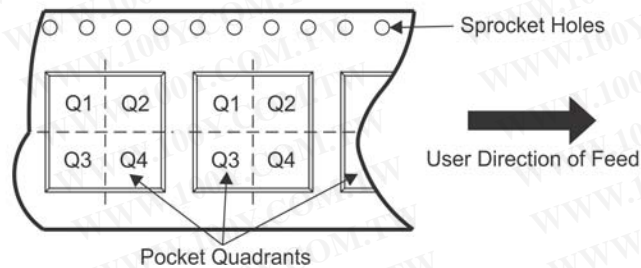
TAPE AND REEL INFORMATION

QUADRANT ASSIGNMENTS FOR PIN 1 ORIENTATION IN TAPE

*All dimensions are nominal

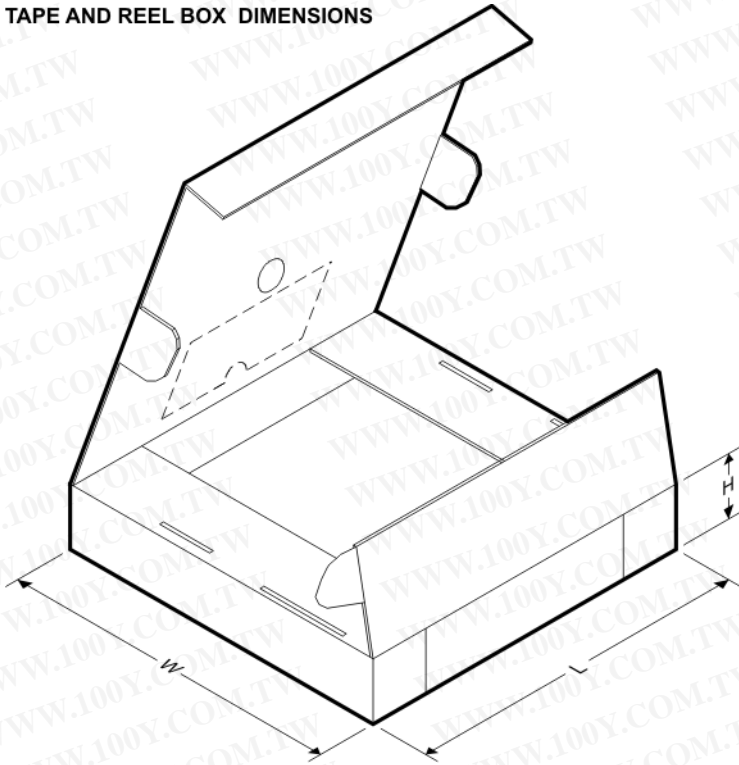
Device	Package Type	Package Drawing	Pins	SPQ	Reel Diameter (mm)	Reel Width W1 (mm)	A0 (mm)	B0 (mm)	K0 (mm)	P1 (mm)	W (mm)	Pin1 Quadrant
LMV7291MG	SC70	DCK	5	1000	178.0	8.4	2.25	2.45	1.2	4.0	8.0	Q3
LMV7291MG/NOPB	SC70	DCK	5	1000	178.0	8.4	2.25	2.45	1.2	4.0	8.0	Q3
LMV7291MGX	SC70	DCK	5	3000	178.0	8.4	2.25	2.45	1.2	4.0	8.0	Q3
LMV7291MGX/NOPB	SC70	DCK	5	3000	178.0	8.4	2.25	2.45	1.2	4.0	8.0	Q3

TAPE AND REEL BOX DIMENSIONS

*All dimensions are nominal

Device	Package Type	Package Drawing	Pins	SPQ	Length (mm)	Width (mm)	Height (mm)
LMV7291MG	SC70	DCK	5	1000	210.0	185.0	35.0
LMV7291MG/NOPB	SC70	DCK	5	1000	210.0	185.0	35.0
LMV7291MGX	SC70	DCK	5	3000	210.0	185.0	35.0
LMV7291MGX/NOPB	SC70	DCK	5	3000	210.0	185.0	35.0

DCK (R-PDSO-G5)

PLASTIC SMALL-OUTLINE PACKAGE

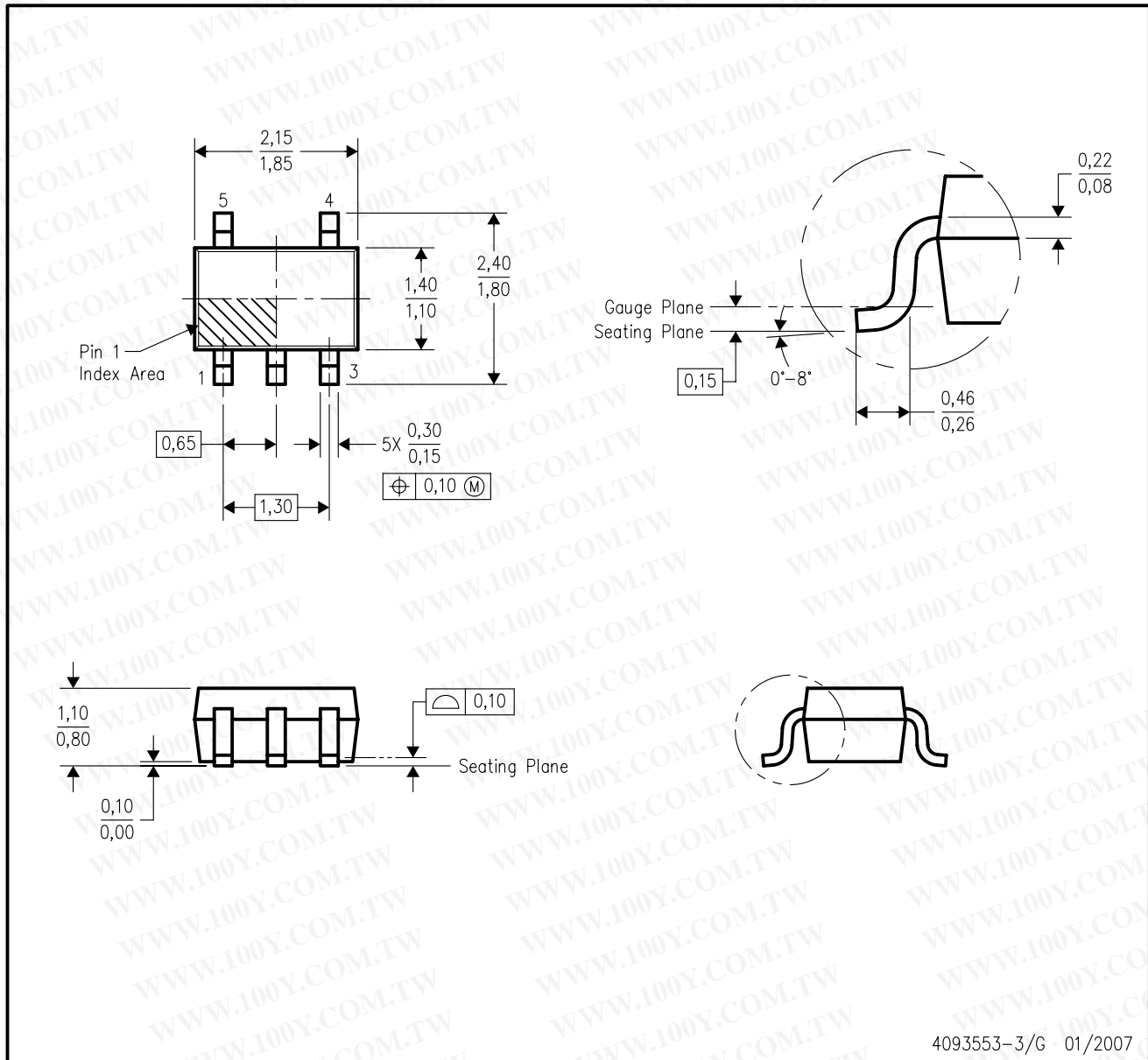

- NOTES:
- All linear dimensions are in millimeters.
 - This drawing is subject to change without notice.
 - Body dimensions do not include mold flash or protrusion. Mold flash and protrusion shall not exceed 0.15 per side.
 - Falls within JEDEC MO-203 variation AA.

勝特力材料 886-3-5753170
勝特力电子(上海) 86-21-34970699
勝特力电子(深圳) 86-755-83298787
Http://www.100y.com.tw

IMPORTANT NOTICE

Texas Instruments Incorporated and its subsidiaries (TI) reserve the right to make corrections, enhancements, improvements and other changes to its semiconductor products and services per JESD46, latest issue, and to discontinue any product or service per JESD48, latest issue. Buyers should obtain the latest relevant information before placing orders and should verify that such information is current and complete. All semiconductor products (also referred to herein as "components") are sold subject to TI's terms and conditions of sale supplied at the time of order acknowledgment.

TI warrants performance of its components to the specifications applicable at the time of sale, in accordance with the warranty in TI's terms and conditions of sale of semiconductor products. Testing and other quality control techniques are used to the extent TI deems necessary to support this warranty. Except where mandated by applicable law, testing of all parameters of each component is not necessarily performed.

TI assumes no liability for applications assistance or the design of Buyers' products. Buyers are responsible for their products and applications using TI components. To minimize the risks associated with Buyers' products and applications, Buyers should provide adequate design and operating safeguards.

TI does not warrant or represent that any license, either express or implied, is granted under any patent right, copyright, mask work right, or other intellectual property right relating to any combination, machine, or process in which TI components or services are used. Information published by TI regarding third-party products or services does not constitute a license to use such products or services or a warranty or endorsement thereof. Use of such information may require a license from a third party under the patents or other intellectual property of the third party, or a license from TI under the patents or other intellectual property of TI.

Reproduction of significant portions of TI information in TI data books or data sheets is permissible only if reproduction is without alteration and is accompanied by all associated warranties, conditions, limitations, and notices. TI is not responsible or liable for such altered documentation. Information of third parties may be subject to additional restrictions.

Resale of TI components or services with statements different from or beyond the parameters stated by TI for that component or service voids all express and any implied warranties for the associated TI component or service and is an unfair and deceptive business practice. TI is not responsible or liable for any such statements.

Buyer acknowledges and agrees that it is solely responsible for compliance with all legal, regulatory and safety-related requirements concerning its products, and any use of TI components in its applications, notwithstanding any applications-related information or support that may be provided by TI. Buyer represents and agrees that it has all the necessary expertise to create and implement safeguards which anticipate dangerous consequences of failures, monitor failures and their consequences, lessen the likelihood of failures that might cause harm and take appropriate remedial actions. Buyer will fully indemnify TI and its representatives against any damages arising out of the use of any TI components in safety-critical applications.

In some cases, TI components may be promoted specifically to facilitate safety-related applications. With such components, TI's goal is to help enable customers to design and create their own end-product solutions that meet applicable functional safety standards and requirements. Nonetheless, such components are subject to these terms.

No TI components are authorized for use in FDA Class III (or similar life-critical medical equipment) unless authorized officers of the parties have executed a special agreement specifically governing such use.

Only those TI components which TI has specifically designated as military grade or "enhanced plastic" are designed and intended for use in military/aerospace applications or environments. Buyer acknowledges and agrees that any military or aerospace use of TI components which have **not** been so designated is solely at the Buyer's risk, and that Buyer is solely responsible for compliance with all legal and regulatory requirements in connection with such use.

TI has specifically designated certain components as meeting ISO/TS16949 requirements, mainly for automotive use. In any case of use of non-designated products, TI will not be responsible for any failure to meet ISO/TS16949.

Products

Audio	www.ti.com/audio
Amplifiers	amplifier.ti.com
Data Converters	dataconverter.ti.com
DLP® Products	www.dlp.com
DSP	dsp.ti.com
Clocks and Timers	www.ti.com/clocks
Interface	interface.ti.com
Logic	logic.ti.com
Power Mgmt	power.ti.com
Microcontrollers	microcontroller.ti.com
RFID	www.ti-rfid.com
OMAP Applications Processors	www.ti.com/omap
Wireless Connectivity	www.ti.com/wirelessconnectivity

Applications

Automotive and Transportation	www.ti.com/automotive
Communications and Telecom	www.ti.com/communications
Computers and Peripherals	www.ti.com/computers
Consumer Electronics	www.ti.com/consumer-apps
Energy and Lighting	www.ti.com/energy
Industrial	www.ti.com/industrial
Medical	www.ti.com/medical
Security	www.ti.com/security
Space, Avionics and Defense	www.ti.com/space-avionics-defense
Video and Imaging	www.ti.com/video

TI E2E Community

e2e.ti.com

Mailing Address: Texas Instruments, Post Office Box 655303, Dallas, Texas 75265
Copyright © 2013, Texas Instruments Incorporated