



1.6 GHz Clock Distribution IC, Dividers, Delay Adjust, Two Outputs

AD9515

FEATURES

- 1.6 GHz differential clock input
- 2 programmable dividers
 - Divide-by in range from 1 to 32
 - Phase select for coarse delay adjust
- 1.6 GHz LVPECL clock output
 - Additive output jitter 225 fs rms
- 800 MHz/250 MHz LVDS/CMOS clock output
 - Additive output jitter 300 fs rms/290 fs rms
 - Time delays up to 10 ns
- Device configured with 4-level logic pins
- Space-saving, 32-lead LFCSP

APPLICATIONS

- Low jitter, low phase noise clock distribution
- Clocking high speed ADCs, DACs, DDSs, DDCs, DUCs, MxFEs
- High performance wireless transceivers
- High performance instrumentation
- Broadband infrastructure
- ATE

GENERAL DESCRIPTION

The AD9515 features a two-output clock distribution IC in a design that emphasizes low jitter and phase noise to maximize data converter performance. Other applications with demanding phase noise and jitter requirements also benefit from this part.

There are two independent clock outputs. One output is LVPECL, while the other output can be set to either LVDS or CMOS levels. The LVPECL output operates to 1.6 GHz. The other output operates to 800 MHz in LVDS mode and to 250 MHz in CMOS mode.

Each output has a programmable divider that can be set to divide by a selected set of integers ranging from 1 to 32. The phase of one clock output relative to the other clock output can be set by means of a divider phase select function that serves as a coarse timing adjustment.

FUNCTIONAL BLOCK DIAGRAM

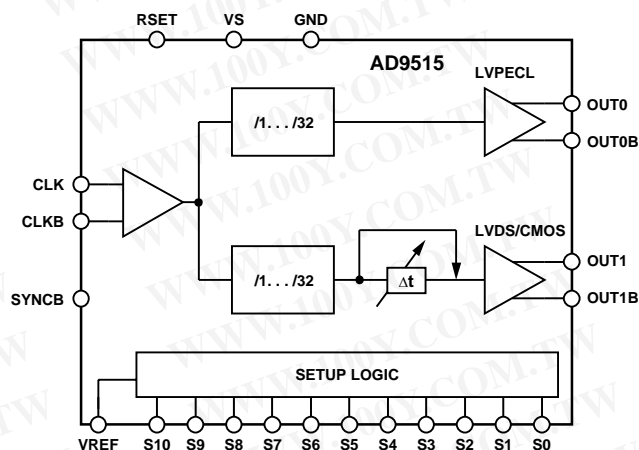

Figure 1.

The LVDS/CMOS output features a delay element with three selectable full-scale delay values (1.5 ns, 5 ns, and 10 ns), each with 16 steps of fine adjustment.

The AD9515 does not require an external controller for operation or setup. The device is programmed by means of 11 pins (S0 to S10) using 4-level logic. The programming pins are internally biased to $\frac{1}{2} V_s$. The VREF pin provides a level of $\frac{2}{3} V_s$. V_s (3.3 V) and GND (0 V) provide the other two logic levels.

The AD9515 is ideally suited for data converter clocking applications where maximum converter performance is achieved by encode signals with subpicosecond jitter.

The AD9515 is available in a 32-lead LFCSP and operates from a single 3.3 V supply. The temperature range is -40°C to $+85^{\circ}\text{C}$.

勝特力材料 886-3-5753170
勝特力电子(上海) 86-21-34970699
勝特力电子(深圳) 86-755-83298787
[Http://www.100y.com.tw](http://www.100y.com.tw)

Rev. 0

Information furnished by Analog Devices is believed to be accurate and reliable. However, no responsibility is assumed by Analog Devices for its use, nor for any infringements of patents or other rights of third parties that may result from its use. Specifications subject to change without notice. No license is granted by implication or otherwise under any patent or patent rights of Analog Devices. Trademarks and registered trademarks are the property of their respective owners.

One Technology Way, P.O. Box 9106, Norwood, MA 02062-9106, U.S.A.
Tel: 781.329.4700 www.analog.com
Fax: 781.461.3113 © 2005 Analog Devices, Inc. All rights reserved.

TABLE OF CONTENTS

Features	1	Synchronization.....	18
Applications.....	1	R _{SET} Resistor	19
Functional Block Diagram	1	VREF.....	19
General Description	1	Setup Configuration.....	19
Revision History	2	Programming.....	20
Specifications.....	3	Divider Phase Offset.....	22
Clock Input.....	3	Delay Block	22
Clock Outputs.....	3	Outputs	23
Timing Characteristics	4	Power Supply.....	23
Clock Output Phase Noise	5	Power Management	24
Clock Output Additive Time Jitter.....	8	Applications.....	25
SYNCB, VREF, and Setup Pins.....	9	Using the AD9515 Outputs for ADC Clock Applications....	25
Power.....	10	LVPECL Clock Distribution	25
Timing Diagrams.....	11	LVDS Clock Distribution.....	26
Absolute Maximum Ratings.....	12	CMOS Clock Distribution	26
Thermal Characteristics	12	Setup Pins (S0 to S10).....	26
ESD Caution.....	12	Power and Grounding Considerations and Power Supply Rejection.....	26
Pin Configuration and Function Descriptions.....	13	Phase Noise and Jitter Measurement Setups.....	27
Terminology	14	Outline Dimensions	28
Typical Performance Characteristics	15	Ordering Guide	28
Functional Description	18		
Overall.....	18		
CLK, CLKB—Differential Clock Input	18		

REVISION HISTORY

7/05—Revision 0: Initial Version

SPECIFICATIONS

Typical (typ) is given for $V_S = 3.3 \text{ V} \pm 5\%$, $T_A = 25^\circ\text{C}$, $R_{SET} = 4.12 \text{ k}\Omega$, LVPECL swing = 790 mV, unless otherwise noted. Minimum (min) and maximum (max) values are given over full V_S and T_A (-40°C to $+85^\circ\text{C}$) variation.

CLOCK INPUT

Table 1.

Parameter	Min	Typ	Max	Unit	Test Conditions/Comments
CLOCK INPUT (CLK)					
Input Frequency ¹	0		1.6	GHz	
Input Sensitivity ¹		150		mV p-p	
Input Common-Mode Voltage, V_{CM}	1.5	1.6	1.7	V	Self-biased; enables ac coupling
Input Common-Mode Range, V_{CMR}	1.3		1.8	V	With 200 mV p-p signal applied; dc-coupled
Input Sensitivity, Single-Ended		150		mV p-p	CLK ac-coupled; CLKB ac-bypassed to RF ground
Input Resistance	4.0	4.8	5.6	k Ω	Self-biased
Input Capacitance		2		pF	

¹A slew rate of 1 V/ns is required to meet jitter, phase noise, and propagation delay specifications.

CLOCK OUTPUTS

Table 2.

Parameter	Min	Typ	Max	Unit	Test Conditions/Comments
LVPECL CLOCK OUTPUT					
(OUT0) Differential					Termination = 50 Ω to $V_S - 2 \text{ V}$
Output Frequency	0		1.6	GHz	
Output High Voltage (V_{OH})	$V_S - 1.1$	$V_S - 0.96$	$V_S - 0.82$	V	
Output Low Voltage (V_{OL})	$V_S - 1.90$	$V_S - 1.76$	$V_S - 1.52$	V	
Output Differential Voltage (V_{OD})	640	790	960	mV	
LVDS CLOCK OUTPUT					
(OUT1) Differential					Termination = 100 Ω differential
Output Frequency	0		800	MHz	
Differential Output Voltage (V_{OD})	250	350	450	mV	
Delta V_{OD}			30	mV	
Output Offset Voltage (V_{OS})	1.125	1.23	1.375	V	
Delta V_{OS}			25	mV	
Short-Circuit Current (I_{SA} , I_{SB})		14	24	mA	Output shorted to GND
CMOS CLOCK OUTPUT					
(OUT1) Single-Ended					Single-ended measurements; termination open
Output Frequency	0		250	MHz	Complementary output on (OUT1B)
Output Voltage High (V_{OH})	$V_S - 0.1$			V	With 5 pF load
Output Voltage Low (V_{OL})			0.1	V	@ 1 mA load
					@ 1 mA load

AD9515

TIMING CHARACTERISTICS

CLK input slew rate = 1 V/ns or greater.

Table 3.

Parameter	Min	Typ	Max	Unit	Test Conditions/Comments
LVPECL					Termination = 50 Ω to $V_S - 2V$
Output Rise Time, t_{RP}		60	100	ps	20% to 80%, measured differentially
Output Fall Time, t_{FP}		60	100	ps	80% to 20%, measured differentially
PROPAGATION DELAY, t_{PECL} , CLK-TO-LVPECL OUT					
Divide = 1	355	480	635	ps	
Divide = 2 – 32	395	530	710	ps	
Variation with Temperature		0.5		ps/°C	
OUTPUT SKEW, LVPECL OUTPUT					
LVPECL OUT Across Multiple Parts, $t_{SKP_AB3}^1$			125	ps	
LVDS					Termination = 100 Ω differential
Output Rise Time, t_{RL}		200	350	ps	20% to 80%, measured differentially
Output Fall Time, t_{FL}		210	350	ps	80% to 20%, measured differentially
PROPAGATION DELAY, t_{LVDS} , CLK-TO-LVDS OUT					Delay off on OUT4
OUT3 to OUT4					
Divide = 1	1.00	1.25	1.55	ns	
Divide = 2 – 32	1.05	1.30	1.60	ns	
Variation with Temperature		0.9		ps/°C	
OUTPUT SKEW, LVDS OUTPUT					Delay off on OUT4
LVDS OUT Across Multiple Parts, $t_{SKV_AB}^1$			230	ps	
CMOS					B outputs are inverted; termination = open
Output Rise Time, t_{RC}		650	865	ps	20% to 80%; $C_{LOAD} = 3\text{ pF}$
Output Fall Time, t_{FC}		650	990	ps	80% to 20%; $C_{LOAD} = 3\text{ pF}$
PROPAGATION DELAY, t_{CMOS} , CLK-TO-CMOS OUT					Delay off on OUT4
Divide = 1	1.10	1.45	1.75	ns	
Divide = 2 – 32	1.15	1.50	1.80	ns	
Variation with Temperature		1		ps/°C	
OUTPUT SKEW, CMOS OUTPUT					Delay off on OUT4
CMOS OUT Across Multiple Parts, $t_{SKC_AB}^1$			300	ps	
LVPECL-TO-LVDS OUT					Everything the same; different logic type
Output Delay, t_{SKP_V}	700	970	1150	ps	LVPECL to LVDS on same part
LVPECL-TO-CMOS OUT					Everything the same; different logic type
Output Delay, t_{SKP_C}	0.88	1.14	1.43	ns	LVPECL to CMOS on same part
DELAY ADJUST (OUT2; LVDS AND CMOS)					
S0 = 1/3					
Zero Scale Delay Time ²		0.34		ns	
Zero Scale Variation with Temperature		0.20		ps/°C	
Full Scale Time Delay ²		1.7		ns	
Full Scale Variation with Temperature		-0.38		ps/°C	
S0 = 2/3					
Zero Scale Delay Time ²		0.45		ns	
Zero Scale Variation with Temperature		0.31		ps/°C	
Full Scale Time Delay ²		5.9		ns	
Full Scale Variation with Temperature		-1.3		ps/°C	

Parameter	Min	Typ	Max	Unit	Test Conditions/Comments
S0 = 1					
Zero Scale Delay Time ²		0.56		ns	
Zero Scale Variation with Temperature		0.47		ps/°C	
Full Scale Time Delay ²		11.4		ns	
Full Scale Variation with Temperature		-5		ps/°C	
Linearity, DNL		0.2		LSB	
Linearity, INL		0.2		LSB	

¹ This is the difference between any two similar delay paths across multiple devices operating at the same voltage and temperature.

² Incremental delay; does not include propagation delay.

CLOCK OUTPUT PHASE NOISE

CLK input slew rate = 1 V/ns or greater.

Table 4.

Parameter	Min	Typ	Max	Unit	Test Conditions/Comments
CLK-TO-LVPECL ADDITIVE PHASE NOISE					
CLK = 622.08 MHz, OUT = 622.08 MHz					
Divide = 1					
@ 10 Hz Offset		-125		dBc/Hz	
@ 100 Hz Offset		-132		dBc/Hz	
@ 1 kHz Offset		-140		dBc/Hz	
@ 10 kHz Offset		-148		dBc/Hz	
@ 100 kHz Offset		-153		dBc/Hz	
>1 MHz Offset		-154		dBc/Hz	
CLK = 622.08 MHz, OUT = 155.52 MHz					
Divide = 4					
@ 10 Hz Offset		-128		dBc/Hz	
@ 100 Hz Offset		-140		dBc/Hz	
@ 1 kHz Offset		-148		dBc/Hz	
@ 10 kHz Offset		-155		dBc/Hz	
@ 100 kHz Offset		-161		dBc/Hz	
>1 MHz Offset		-161		dBc/Hz	
CLK = 622.08 MHz, OUT = 38.88 MHz					
Divide = 16					
@ 10 Hz Offset		-135		dBc/Hz	
@ 100 Hz Offset		-145		dBc/Hz	
@ 1 kHz Offset		-158		dBc/Hz	
@ 10 kHz Offset		-165		dBc/Hz	
@ 100 kHz Offset		-165		dBc/Hz	
>1 MHz Offset		-166		dBc/Hz	
CLK = 491.52 MHz, OUT = 61.44 MHz					
Divide = 8					
@ 10 Hz Offset		-131		dBc/Hz	
@ 100 Hz Offset		-142		dBc/Hz	
@ 1 kHz Offset		-153		dBc/Hz	
@ 10 kHz Offset		-160		dBc/Hz	
@ 100 kHz Offset		-165		dBc/Hz	
> 1 MHz Offset		-165		dBc/Hz	

AD9515

Parameter	Min	Typ	Max	Unit	Test Conditions/Comments
CLK = 491.52 MHz, OUT = 245.76 MHz Divide = 2 @ 10 Hz Offset @ 100 Hz Offset @ 1 kHz Offset @ 10 kHz Offset @ 100 kHz Offset >1 MHz Offset CLK = 245.76 MHz, OUT = 61.44 MHz Divide = 4 @ 10 Hz Offset @ 100 Hz Offset @ 1 kHz Offset @ 10 kHz Offset @ 100 kHz Offset >1 MHz Offset					
		-125		dBc/Hz	
		-132		dBc/Hz	
		-140		dBc/Hz	
		-151		dBc/Hz	
		-157		dBc/Hz	
		-158		dBc/Hz	
		-138		dBc/Hz	
		-144		dBc/Hz	
		-154		dBc/Hz	
		-163		dBc/Hz	
		-164		dBc/Hz	
		-165		dBc/Hz	
CLK-TO-LVDS ADDITIVE PHASE NOISE CLK = 622.08 MHz, OUT = 622.08 MHz Divide = 1 @ 10 Hz Offset @ 100 Hz Offset @ 1 kHz Offset @ 10 kHz Offset @ 100 kHz Offset @ 1 MHz Offset >10 MHz Offset CLK = 622.08 MHz, OUT = 155.52 MHz Divide = 4 @ 10 Hz Offset @ 100 Hz Offset @ 1 kHz Offset @ 10 kHz Offset @ 100 kHz Offset @ 1 MHz Offset >10 MHz Offset CLK = 491.52 MHz, OUT = 245.76 MHz Divide = 2 @ 10 Hz Offset @ 100 Hz Offset @ 1 kHz Offset @ 10 kHz Offset @ 100 kHz Offset @ 1 MHz Offset >10 MHz Offset					
		-100		dBc/Hz	
		-110		dBc/Hz	
		-118		dBc/Hz	
		-129		dBc/Hz	
		-135		dBc/Hz	
		-140		dBc/Hz	
		-148		dBc/Hz	
		-112		dBc/Hz	
		-122		dBc/Hz	
		-132		dBc/Hz	
		-142		dBc/Hz	
		-148		dBc/Hz	
		-152		dBc/Hz	
		-155		dBc/Hz	
		-108		dBc/Hz	
		-118		dBc/Hz	
		-128		dBc/Hz	
		-138		dBc/Hz	
		-145		dBc/Hz	
		-148		dBc/Hz	
		-154		dBc/Hz	

Parameter	Min	Typ	Max	Unit	Test Conditions/Comments
CLK = 491.52 MHz, OUT = 122.88 MHz					
Divide = 4					
@ 10 Hz Offset		-118		dBc/Hz	
@ 100 Hz Offset		-129		dBc/Hz	
@ 1 kHz Offset		-136		dBc/Hz	
@ 10 kHz Offset		-147		dBc/Hz	
@ 100 kHz Offset		-153		dBc/Hz	
@ 1 MHz Offset		-156		dBc/Hz	
>10 MHz Offset		-158		dBc/Hz	
CLK = 245.76 MHz, OUT = 245.76 MHz					
Divide = 1					
@ 10 Hz Offset		-108		dBc/Hz	
@ 100 Hz Offset		-118		dBc/Hz	
@ 1 kHz Offset		-128		dBc/Hz	
@ 10 kHz Offset		-138		dBc/Hz	
@ 100 kHz Offset		-145		dBc/Hz	
@ 1 MHz Offset		-148		dBc/Hz	
>10 MHz Offset		-155		dBc/Hz	
CLK = 245.76 MHz, OUT = 122.88 MHz					
Divide = 2					
@ 10 Hz Offset		-118		dBc/Hz	
@ 100 Hz Offset		-127		dBc/Hz	
@ 1 kHz Offset		-137		dBc/Hz	
@ 10 kHz Offset		-147		dBc/Hz	
@ 100 kHz Offset		-154		dBc/Hz	
@ 1 MHz Offset		-156		dBc/Hz	
>10 MHz Offset		-158		dBc/Hz	
CLK-TO-CMOS ADDITIVE PHASE NOISE					
CLK = 245.76 MHz, OUT = 245.76 MHz					
Divide = 1					
@ 10 Hz Offset		-110		dBc/Hz	
@ 100 Hz Offset		-121		dBc/Hz	
@ 1 kHz Offset		-130		dBc/Hz	
@ 10 kHz Offset		-140		dBc/Hz	
@ 100 kHz Offset		-145		dBc/Hz	
@ 1 MHz Offset		-149		dBc/Hz	
>10 MHz Offset		-156		dBc/Hz	
CLK = 245.76 MHz, OUT = 61.44 MHz					
Divide = 4					
@ 10 Hz Offset		-125		dBc/Hz	
@ 100 Hz Offset		-132		dBc/Hz	
@ 1 kHz Offset		-143		dBc/Hz	
@ 10 kHz Offset		-152		dBc/Hz	
@ 100 kHz Offset		-158		dBc/Hz	
@ 1 MHz Offset		-160		dBc/Hz	
>10 MHz Offset		-162		dBc/Hz	

AD9515

Parameter	Min	Typ	Max	Unit	Test Conditions/Comments
CLK = 78.6432 MHz, OUT = 78.6432 MHz					
Divide = 1					
@ 10 Hz Offset		-122		dBc/Hz	
@ 100 Hz Offset		-132		dBc/Hz	
@ 1 kHz Offset		-140		dBc/Hz	
@ 10 kHz Offset		-150		dBc/Hz	
@ 100 kHz Offset		-155		dBc/Hz	
@ 1 MHz Offset		-158		dBc/Hz	
>10 MHz Offset		-160		dBc/Hz	
CLK = 78.6432 MHz, OUT = 39.3216 MHz					
Divide = 2					
@ 10 Hz Offset		-128		dBc/Hz	
@ 100 Hz Offset		-136		dBc/Hz	
@ 1 kHz Offset		-146		dBc/Hz	
@ 10 kHz Offset		-155		dBc/Hz	
@ 100 kHz Offset		-161		dBc/Hz	
>1 MHz Offset		-162		dBc/Hz	

CLOCK OUTPUT ADDITIVE TIME JITTER

Table 5.

Parameter	Min	Typ	Max	Unit	Test Conditions/Comments
LVPECL OUTPUT ADDITIVE TIME JITTER					
CLK = 622.08 MHz		40		fs rms	BW = 12 kHz – 20 MHz (OC-12)
LVPECL (OUT0) = 622.08 MHz					OUT1 off
Divide = 1					
CLK = 622.08 MHz		55		fs rms	BW = 12 kHz – 20 MHz (OC-3)
LVPECL (OUT0) = 155.52 MHz					OUT1 off
Divide = 4					
CLK = 400 MHz		215		fs rms	Calculated from SNR of ADC method
LVPECL (OUT0) = 100 MHz					OUT1 off
Divide = 4					
CLK = 400 MHz		215		fs rms	Calculated from SNR of ADC method
LVPECL (OUT0) = 100 MHz					
Divide = 4					
LVDS (OUT1) = 100 MHz					Interferer
CLK = 400 MHz		225		fs rms	Calculated from SNR of ADC method
LVPECL (OUT0) = 100 MHz					
Divide = 4					
LVDS (OUT1) = 50 MHz					Interferer
CLK = 400 MHz		230		fs rms	Calculated from SNR of ADC method
LVPECL (OUT0) = 100 MHz					
Divide = 4					
CMOS (OUT1) = 50 MHz					Interferer
LVDS OUTPUT ADDITIVE TIME JITTER					
CLK = 400 MHz		300		fs rms	Delay off
LVDS (OUT1) = 100 MHz					Calculated from SNR of ADC method
Divide = 4					OUT0 off
CLK = 400 MHz		350		fs rms	Calculated from SNR of ADC method
LVDS (OUT1) = 100 MHz					OUT0 off
Divide = 4					
LVPECL (OUT0) = 50 MHz					Interferer

Parameter	Min	Typ	Max	Unit	Test Conditions/Comments
CMOS OUTPUT ADDITIVE TIME JITTER					Delay off
CLK = 400 MHz CMOS (OUT1) = 100 MHz Divide = 4		290		fs rms	Calculated from SNR of ADC method
CLK = 400 MHz CMOS (OUT1) = 100 MHz Divide = 4 LVPECL (OUT0) = 50 MHz		315		fs rms	Calculated from SNR of ADC method Interferer
DELAY BLOCK ADDITIVE TIME JITTER ¹					100 MHz output; incremental additive jitter
Delay FS = 1.5 ns Fine Adj. 00000		0.71		ps rms	
Delay FS = 1.5 ns Fine Adj. 11111		1.2		ps rms	
Delay FS = 5 ns Fine Adj. 00000		1.3		ps rms	
Delay FS = 5 ns Fine Adj. 11111		2.7		ps rms	
Delay FS = 10 ns Fine Adj. 00000		2.0		ps rms	
Delay FS = 10 ns Fine Adj. 11111		2.8		ps rms	

¹ This value is incremental. That is, it is in addition to the jitter of the LVDS or CMOS output without the delay. To estimate the total jitter, the LVDS or CMOS output jitter should be added to this value using the root sum of the squares (RSS) method.

SYNCB, VREF, AND SETUP PINS

Table 6.

Parameter	Min	Typ	Max	Unit	Test Conditions/Comments
SYNCB					
Logic High	2.7			V	
Logic Low			0.40	V	
Capacitance		2		pF	
VREF					
Output Voltage	0.62 V _S		0.76 V _S	V	Minimum – maximum from 0 mA to 1 mA load
S0 TO S10					
Levels					
0			0.1 V _S	V	
1/3	0.2 V _S		0.45 V _S	V	
2/3	0.55 V _S		0.8 V _S	V	
1	0.9 V _S			V	

AD9515

POWER

Table 7.

Parameter	Min	Typ	Max	Unit	Test Conditions/Comments
POWER-ON SYNCHRONIZATION ¹ V _S Transit Time from 2.2 V to 3.1 V			35	ms	See the Power-On SYNC section.
POWER DISSIPATION	215	285	380	mW	Both outputs on. LVPECL (divide = 2), LVDS (divide = 2). No clock. Does not include power dissipated in external resistors.
	300	370	465	mW	Both outputs on. LVPECL (divide = 2), CMOS (divide = 2); at 62.5 MHz out (5 pF load).
	330	405	510	mW	Both outputs on. LVPECL, CMOS (divide = 2); at 125 MHz out (5 pF load).
POWER DELTA					
Divider (Divide = 2 to Divide = 1)	15	30	45	mW	For each divider. No clock.
LVPECL Output	65	90	125	mW	For each output. No clock.
LVDS Output	20	50	85	mW	No clock.
CMOS Output (Static)	30	40	50	mW	No clock.
CMOS Output (@ 62.5 MHz)	80	110	140	mW	Single-ended. At 62.5 MHz out with 5 pF load.
CMOS Output (@ 125 MHz)	110	150	190	mW	Single-ended. At 125 MHz out with 5 pF load.
Delay Block	30	45	65	mW	Off to 1.5 ns fs, delay word = 60; output clocking at 62.5 MHz.

¹ This is the rise time of the V_S supply that is required to ensure that a synchronization of the outputs occurs on power-up. The critical factor is the time it takes the V_S to transition the range from 2.2 V to 3.1 V. If the rise time is too slow, the outputs will not be synchronized.

TIMING DIAGRAMS

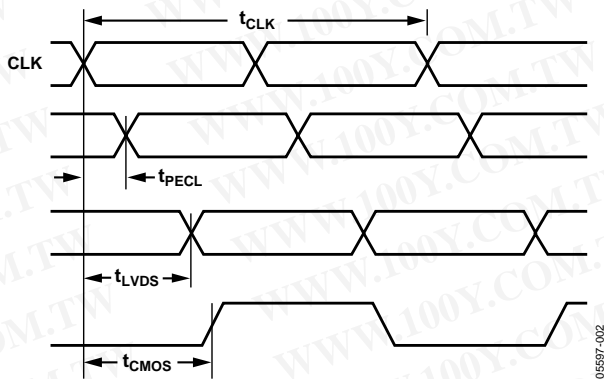

Figure 2. CLK/CLKB to Clock Output Timing, Divide = 1 Mode

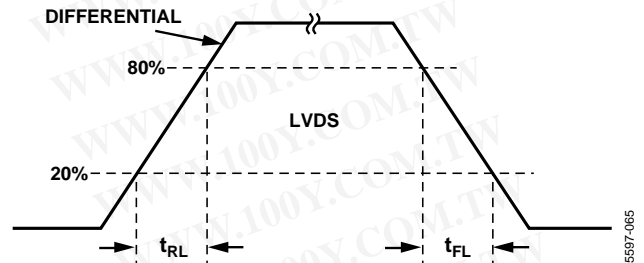

Figure 4. LVDS Timing, Differential

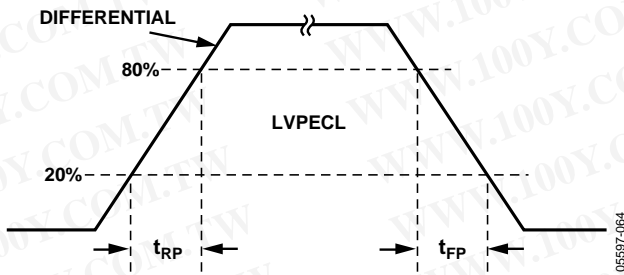

Figure 3. LVPECL Timing, Differential

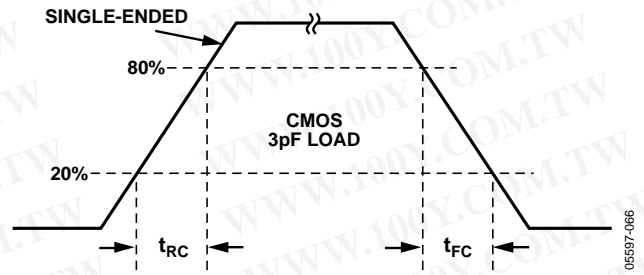

Figure 5. CMOS Timing, Single-Ended, 3 pF Load

ABSOLUTE MAXIMUM RATINGS

Table 8.

Parameter or Pin	With Respect to	Min	Max	Unit
VS	GND	-0.3	+3.6	V
RSET	GND	-0.3	$V_S + 0.3$	V
CLK, CLKB	GND	-0.3	$V_S + 0.3$	V
CLK	CLKB	-1.2	+1.2	V
OUT0, OUT0B, OUT1, OUT1B	GND	-0.3	$V_S + 0.3$	V
Junction Temperature ¹			150	°C
Storage Temperature		-65	+150	°C
Lead Temperature (10 sec)			300	°C

Stresses above those listed under Absolute Maximum Ratings may cause permanent damage to the device. This is a stress rating only; functional operation of the device at these or any other conditions above those indicated in the operational section of this specification is not implied. Exposure to absolute maximum ratings for extended periods may affect device reliability.

THERMAL CHARACTERISTICS²

Thermal Resistance

32-Lead LFCSP³

$$\theta_{JA} = 36.6^{\circ}\text{C/W}$$

¹ See Thermal Characteristics for θ_{JA} .

² Thermal impedance measurements were taken on a 4-layer board in still air in accordance with EIA/JESD51-7.

³ The external pad of this package must be soldered to adequate copper land on board.

ESD CAUTION

ESD (electrostatic discharge) sensitive device. Electrostatic charges as high as 4000 V readily accumulate on the human body and test equipment and can discharge without detection. Although this product features proprietary ESD protection circuitry, permanent damage may occur on devices subjected to high energy electrostatic discharges. Therefore, proper ESD precautions are recommended to avoid performance degradation or loss of functionality.



PIN CONFIGURATION AND FUNCTION DESCRIPTIONS

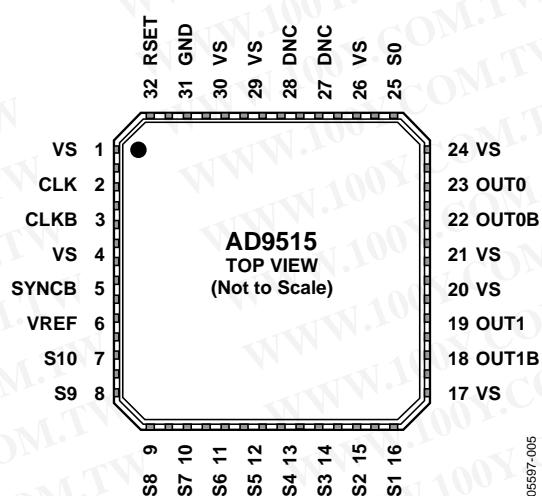

Figure 6. 32-Lead LFCSP Pin Configuration

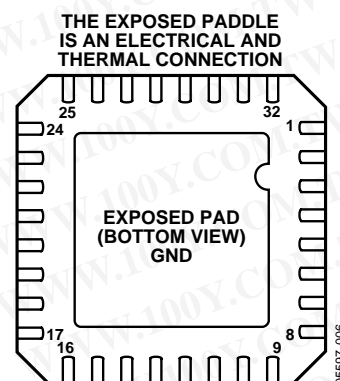

Figure 7. Exposed Paddle

Note that the exposed paddle on this package is an electrical connection as well as a thermal enhancement. For the device to function properly, the paddle *must* be soldered to a PCB land that functions as both a heat dissipation path as well as an electrical ground (analog).

Table 9. Pin Function Descriptions

Pin No.	Mnemonic	Description
1, 4, 17, 20, 21, 24, 26, 29, 30	VS	Power Supply (3.3 V).
2	CLK	Clock Input.
3	CLKB	Complementary Clock Input. Used in conjunction with CLK.
5	SYNCB	Used to Synchronize the Outputs; Active Low Signal.
6	VREF	Provides 2/3 V _s Reference Voltage for Use with Programming Pins S0 to S10.
7 to 16, 25	S0 to S10	Programming Pins. These pins determine the operation of the AD9515; 4-state logic.
18	OUT1B	Complementary LVDS/Inverted CMOS Output. Includes a delay block.
19	OUT1	LVDS/CMOS Output. Includes a delay block.
22	OUT0B	Complementary LVPECL Output.
23	OUT0	LVPECL Output.
27, 28	DNC	Do Not Connect.
31, Exposed Paddle	GND	Ground. The exposed paddle on the back of the chip is also GND.
32	RSET	Current Sets Resistor to Ground. Nominal value = 4.12 kΩ.

TERMINOLOGY

Phase Jitter and Phase Noise

An ideal sine wave can be thought of as having a continuous and even progression of phase with time from 0 to 360 degrees for each cycle. Actual signals, however, display a certain amount of variation from ideal phase progression over time. This phenomenon is called phase jitter. Although there are many causes that can contribute to phase jitter, one major component is due to random noise that is characterized statistically as being Gaussian (normal) in distribution.

This phase jitter leads to a spreading out of the energy of the sine wave in the frequency domain, producing a continuous power spectrum. This power spectrum is usually reported as a series of values whose units are dBc/Hz at a given offset in frequency from the sine wave (carrier). The value is a ratio (expressed in dB) of the power contained within a 1 Hz bandwidth with respect to the power at the carrier frequency. For each measurement, the offset from the carrier frequency is also given.

It is also meaningful to integrate the total power contained within some interval of offset frequencies (for example, 10 kHz to 10 MHz). This is called the integrated phase noise over that frequency offset interval and can be readily related to the time jitter due to the phase noise within that offset frequency interval.

Phase noise has a detrimental effect on the performance of ADCs, DACs, and RF mixers. It lowers the achievable dynamic range of the converters and mixers, although they are affected in somewhat different ways.

Time Jitter

Phase noise is a frequency domain phenomenon. In the time domain, the same effect is exhibited as time jitter. When observing a sine wave, the time of successive zero crossings is seen to vary. For a square wave, the time jitter is seen as a displacement of the edges from their ideal (regular) times of occurrence. In both cases, the variations in timing from the ideal are the time jitter. Since these variations are random in nature, the time jitter is specified in units of seconds root mean square (rms) or 1 sigma of the Gaussian distribution.

Time jitter that occurs on a sampling clock for a DAC or an ADC decreases the SNR and dynamic range of the converter. A sampling clock with the lowest possible jitter provides the highest performance from a given converter.

Additive Phase Noise

It is the amount of phase noise that is attributable to the device or subsystem being measured. The phase noise of any external oscillators or clock sources has been subtracted. This makes it possible to predict the degree to which the device affects the total system phase noise when used in conjunction with the various oscillators and clock sources, each of which contribute their own phase noise to the total. In many cases, the phase noise of one element dominates the system phase noise.

Additive Time Jitter

It is the amount of time jitter that is attributable to the device or subsystem being measured. The time jitter of any external oscillators or clock sources has been subtracted. This makes it possible to predict the degree to which the device will affect the total system time jitter when used in conjunction with the various oscillators and clock sources, each of which contribute their own time jitter to the total. In many cases, the time jitter of the external oscillators and clock sources dominates the system time jitter.

TYPICAL PERFORMANCE CHARACTERISTICS

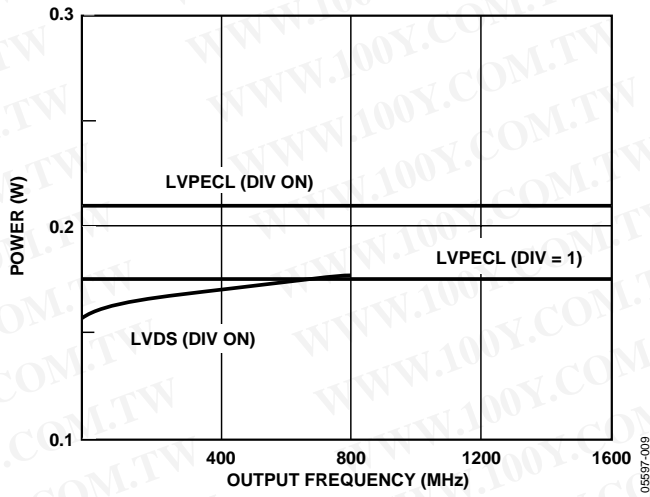

Figure 8. Power vs. Frequency—LVPECL, LVDS

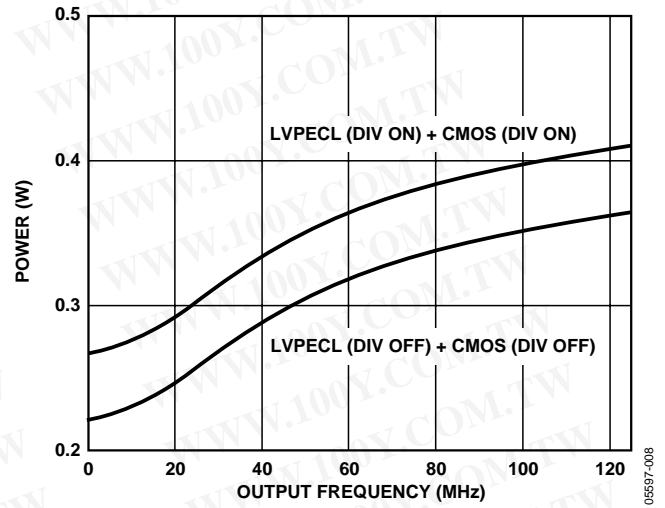

Figure 10. Power vs. Frequency—LVPECL, CMOS

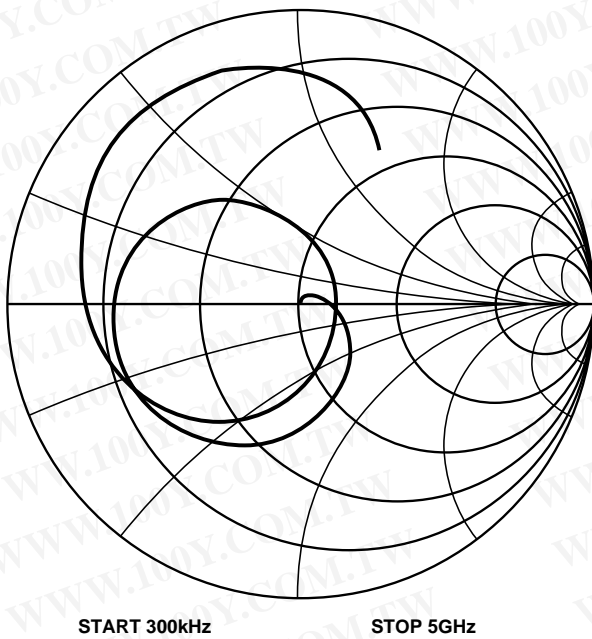

Figure 9. CLK Smith Chart (Evaluation Board)

AD9515

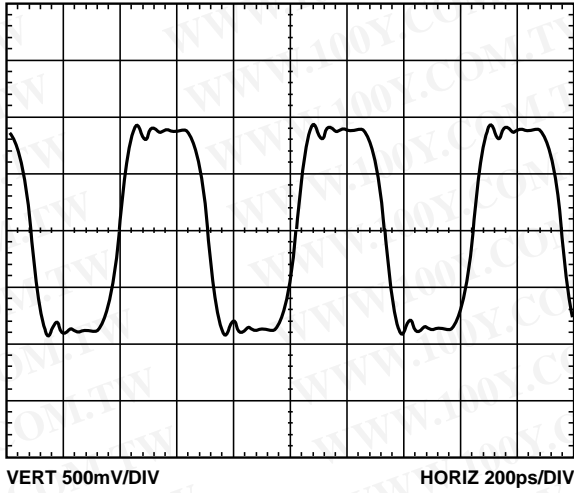

Figure 11. LVPECL Differential Output @ 1600 MHz

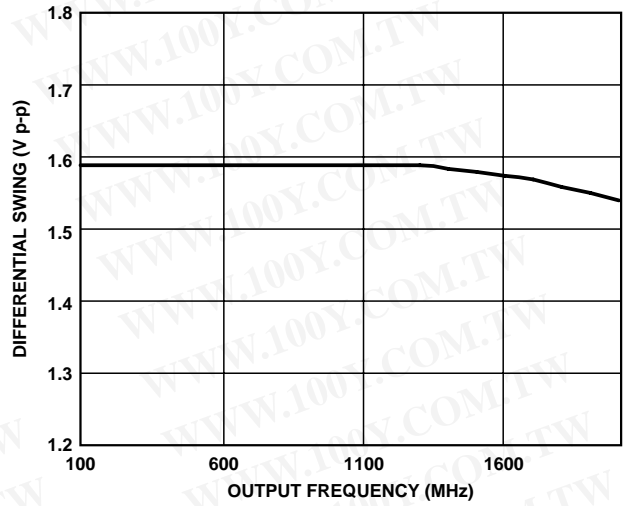

Figure 14. LVPECL Differential Output Swing vs. Frequency

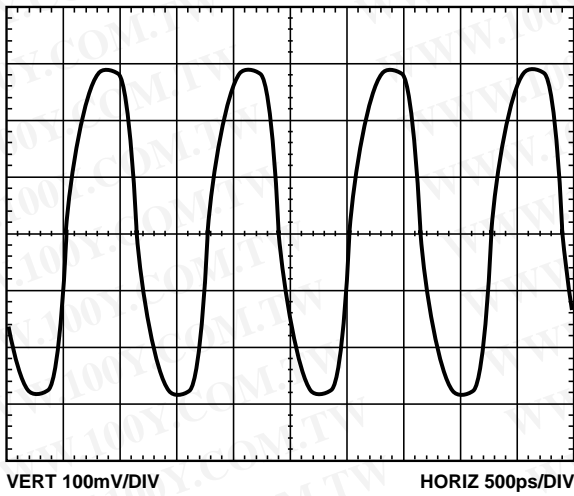

Figure 12. LVDS Differential Output @ 800 MHz

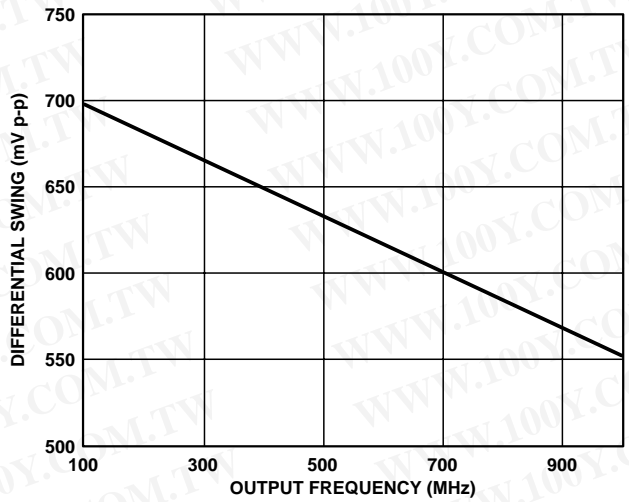

Figure 15. LVDS Differential Output Swing vs. Frequency

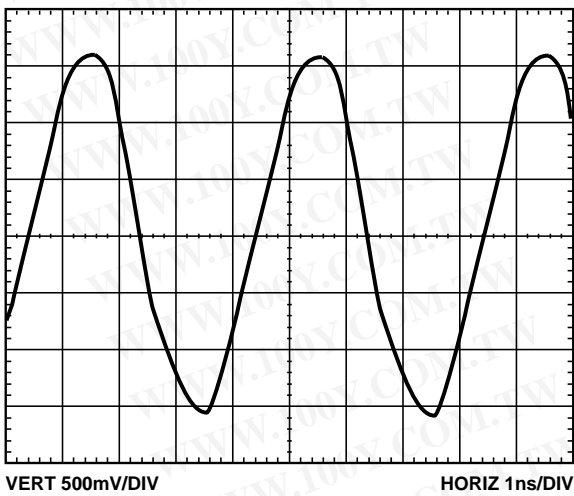

Figure 13. CMOS Single-Ended Output @ 250 MHz with 10 pF Load

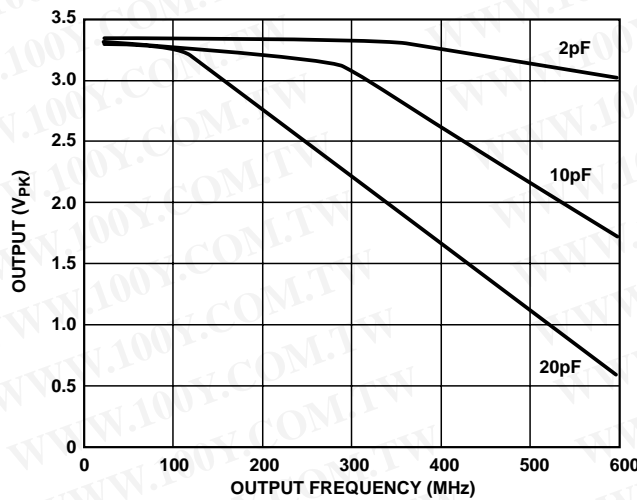

Figure 16. CMOS Single-Ended Output Swing vs. Frequency and Load

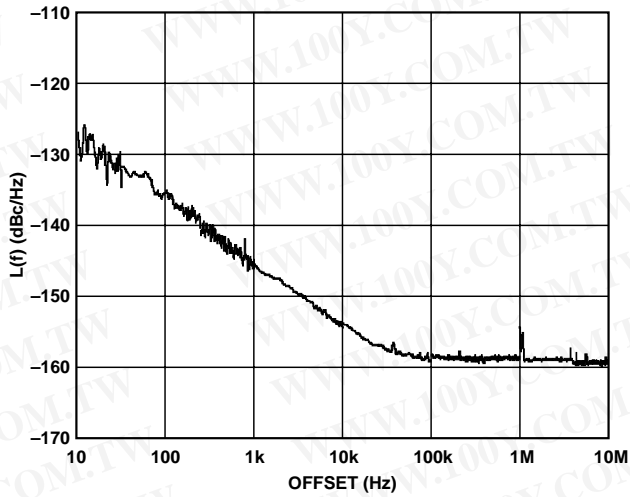

Figure 17. Additive Phase Noise—LVPECL, Divide = 1, 245.76 MHz

05597-061

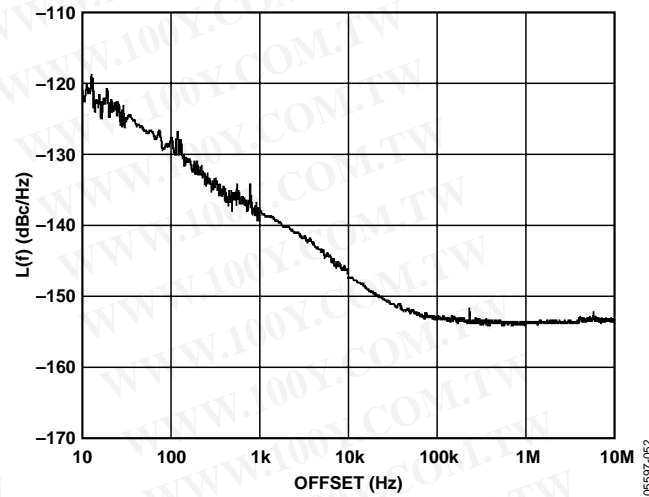

Figure 20. Additive Phase Noise—LVPECL, Divide = 1, 622.08 MHz

05597-062

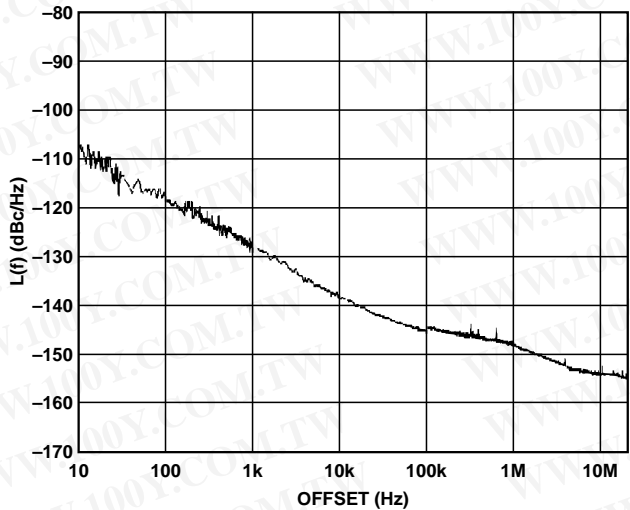

Figure 18. Additive Phase Noise—LVDS, Divide = 1, 245.76 MHz

05597-048

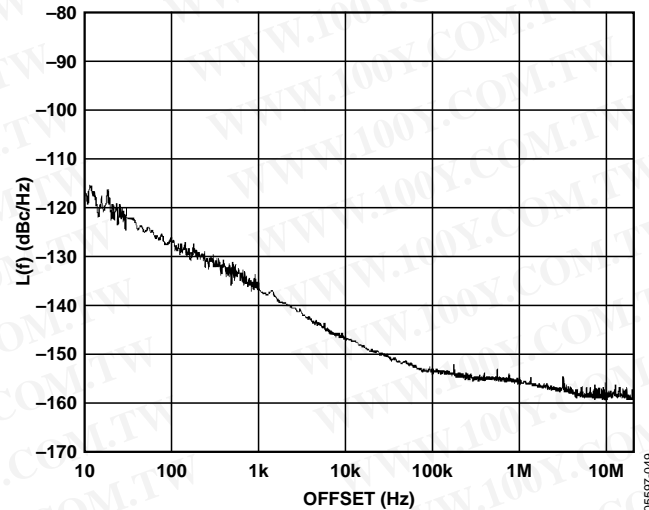

Figure 21. Additive Phase Noise—LVDS, Divide = 2, 122.88 MHz

05597-049

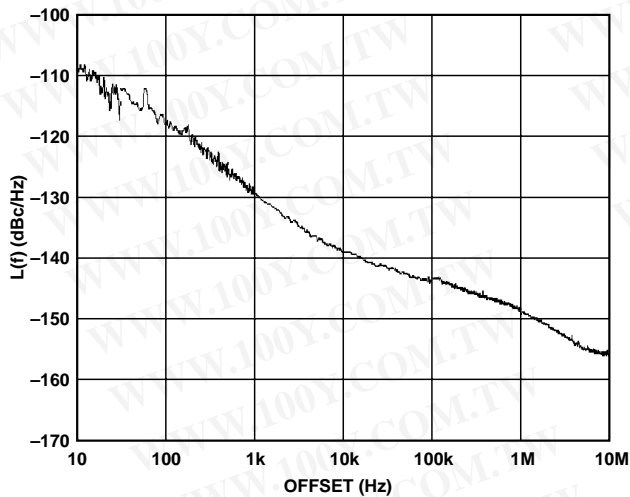

Figure 19. Additive Phase Noise—CMOS, Divide = 1, 245.76 MHz

05597-045

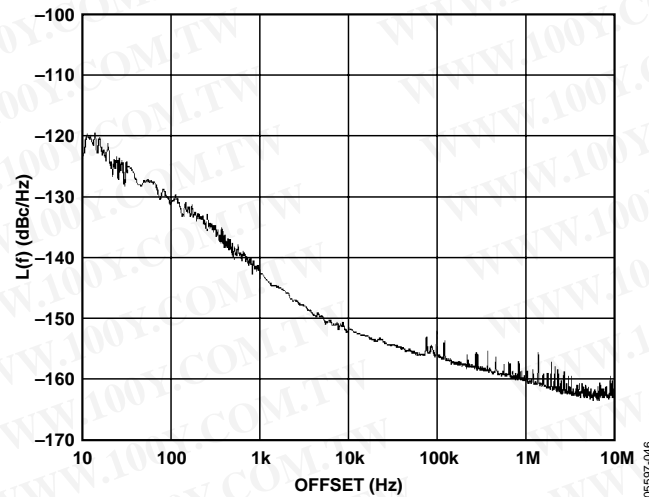

Figure 22. Additive Phase Noise—CMOS, Divide = 4, 61.44 MHz

05597-046

FUNCTIONAL DESCRIPTION

OVERALL

The AD9515 provides for the distribution of its input clock on one or both of its outputs. OUT0 is an LVPECL output. OUT1 can be set to either LVDS or CMOS logic levels. Each output has its own divider that can be set for a divide ratio selected from a list of integer values from 1 (bypassed) to 32.

OUT1 includes an analog delay block that can be set to add an additional delay of 1.5 ns, 5 ns, or 10 ns full scale, each with 16 levels of fine adjustment.

CLK, CLKB—DIFFERENTIAL CLOCK INPUT

The CLK and CLKB pins are differential clock input pins. This input works up to 1600 MHz. The jitter performance is degraded by a slew rate below 1 V/ns. The input level should be between approximately 150 mV p-p to no more than 2 V p-p. Anything greater can result in turning on the protection diodes on the input pins.

See Figure 23 for the CLK equivalent input circuit. This input is fully differential and self-biased. The signal should be ac-coupled using capacitors. If a single-ended input must be used, this can be accommodated by ac coupling to one side of the differential input only. The other side of the input should be bypassed to a quiet ac ground by a capacitor.

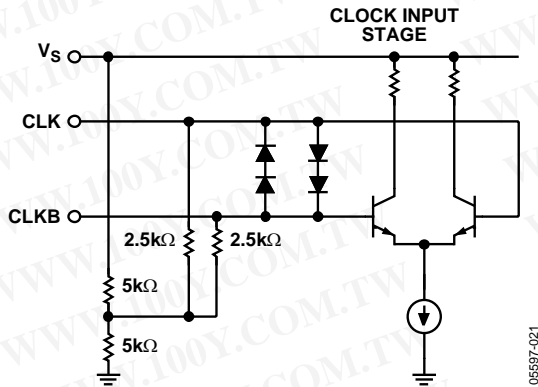

Figure 23. Clock Input Equivalent Circuit

SYNCHRONIZATION

Power-On SYNC

A power-on sync (POS) is issued when the V_s power supply is turned on to ensure that the outputs start in synchronization. The power-on sync works only if the V_s power supply transitions the region from 2.2 V to 3.1 V within 35 ms. The POS can occur up to 65 ms after V_s crosses 2.2 V. Only outputs which are not divide = 1 are synchronized.

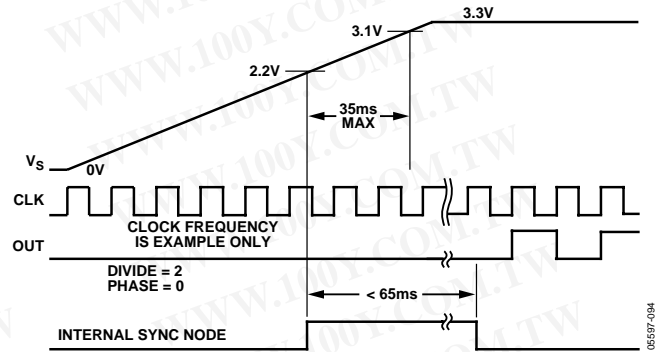

Figure 24. Power-On Sync Timing

SYNCB

If the setup configuration of the AD9515 is changed during operation, the outputs can become unsynchronized. The outputs can be re-synchronized to each other at any time. Synchronization occurs when the SYNCB pin is pulled low and released. The clock outputs (except where divide = 1) are forced into a fixed state (determined by the divide and phase settings) and held there in a static condition, until the SYNCB pin is returned to high. Upon release of the SYNCB pin, after four cycles of the clock signal at CLK, all outputs continue clocking in synchronicity (except where divide = 1).

When divide = 1 for an output, that output is not affected by SYNCB.

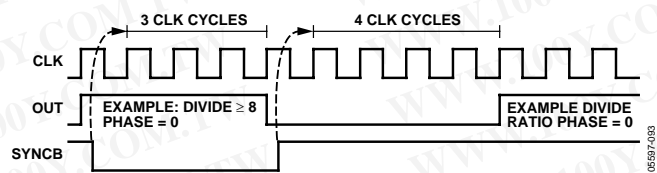

Figure 25. SYNCB Timing with Clock Present

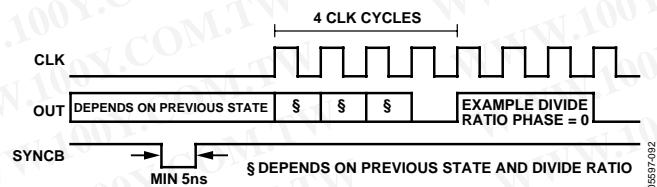

Figure 26. SYNCB Timing with No Clock Present

The outputs of the AD9515 can be synchronized by using the SYNCB pin. Synchronization aligns the phases of the clock outputs, respecting any phase offset that has been set on an output's divider.

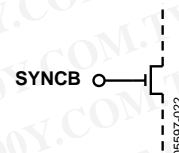

Figure 27. SYNCB Equivalent Input Circuit

Synchronization is initiated by pulling the SYNCB pin low for a minimum of 5 ns. The input clock does not have to be present at the time the command is issued. The synchronization occurs after four input clock cycles.

The synchronization applies to clock outputs:

- that are not turned OFF
- where the divider is not divide = 1 (divider bypassed)

An output with its divider set to divide = 1 (divider bypassed) is always synchronized with the input clock, with a propagation delay.

The SYNCB pin must be pulled up for normal operation. Do not let the SYNCB pin float.

R_{SET} RESISTOR

The internal bias currents of the AD9515 are set by the R_{SET} resistor. This resistor should be as close as possible to the value given as a condition in the Specifications section (R_{SET} = 4.12 kΩ). This is a standard 1% resistor value and should be readily obtainable. The bias currents set by this resistor determine the logic levels and operating conditions of the internal blocks of the AD9515. The performance figures given in the Specifications section assume that this resistor value is used for R_{SET}.

VREF

The VREF pin provides a voltage level of $\frac{2}{3} V_S$. This voltage is one of the four logic levels used by the setup pins (S0 to S10). These pins set the operation of the AD9515. The VREF pin provides sufficient drive capability to drive as many of the setup pins as necessary, up to all on a single part. The VREF pin should be used for no other purpose.

SETUP CONFIGURATION

The specific operation of the AD9515 is set by the logic levels applied to the setup pins (S10 to S0). These pins use four-state logic. The logic levels used are V_S and GND, plus $\frac{1}{3} V_S$ and $\frac{2}{3} V_S$. The $\frac{1}{3} V_S$ level is provided by the internal self-biasing on each of the setup pins (S10 to S0). This is the level seen by a setup pin that is left not connected (NC). The $\frac{2}{3} V_S$ level is

provided by the VREF pin. All setup pins requiring the $\frac{2}{3} V_S$ level must be tied to the VREF pin.

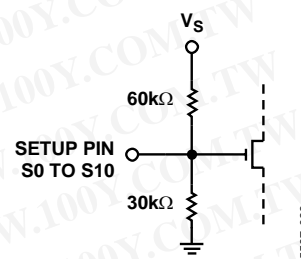

Figure 28. Setup Pin (S0 to S10) Equivalent Circuit

The AD9515 operation is determined by the combination of logic levels present at the setup pins. The setup configurations for the AD9515 are shown in Table 10 to Table 15. The four logic levels are referred to as 0, $\frac{1}{3}$, $\frac{2}{3}$, and 1. These numbers represent the fraction of the V_S voltage that defines the logic levels. See the setup pin thresholds in Table 6.

The meaning of some of the setup pins depends on the logic level set on other pins. For example, the effect of the S9/S10 pair of pins depends on the state of S8. S8 selects whether the phase value selected by S9/S10 affects either OUT0 or OUT1. In addition, if OUT1 is selected to have its phase controlled, the effect further depends on the state of S0. If S = 0, the delay block for OUT1 is bypassed, and the logic levels on S9/S10 set the phase value of the OUT1 divider. However, if S0 ≠ 0, then the full-scale delay for OUT1 is set by the logic level on S0, and S9/S10 set the delay block fine delay (fraction of full scale).

Additionally, if a nonzero phase value is selected by S2/S3/S4 (for OUT0) or S5/S6/S7 (for OUT1), this phase overrides the phase value selected by S9/S10. This allows a phase delay to be selected on OUT0 while also selecting a time delay on OUT1.

S1 selects the logic level of each output. OUT0 is LVPECL. The LVPECL output differential voltage (V_{OD}) can be selected from two levels: 400 mV or 780 mV. OUT1 can be set to either LVDS or CMOS levels.

OUT0 can be turned off (powered down) by setting S2/S3/S4 to 0/1/0. OUT1 can be turned off by setting S5/S6/S7 to 0/1/0.

Do not set S2/S3/S4/S5/S6/S7 to 1/1/1/1/1/1.

AD9515

PROGRAMMING

Table 10. S0—OUT1 Delay Full Scale

S0	Delay
0	Bypassed
1/3	1.5 ns
2/3	5 ns
1	10 ns

Table 11. S1—Output Logic Configuration

S1	OUT0	OUT1
0	LVPECL 790 mV	LVDS
1/3	LVPECL 400 mV	LVDS
2/3	LVPECL 790 mV	CMOS
1	LVPECL 400 mV	CMOS

Table 12. S2, S3, and S4—OUT0

S2	S3	S4	OUT0 Divide (Duty Cycle ¹)	OUT0 Phase
0	0	0	1	0
1/3	0	0	2 (50%)	0
2/3	0	0	3 (33%)	0
1	0	0	4 (50%)	0
0	1/3	0	5 (40%)	0
1/3	1/3	0	6 (50%)	0
2/3	1/3	0	7 (43%)	0
1	1/3	0	8 (50%)	0
0	2/3	0	9 (44%)	0
1/3	2/3	0	10 (50%)	0
2/3	2/3	0	11 (45%)	0
1	2/3	0	12 (50%)	0
0	1	0	OUT0 OFF	0
1/3	1	0	14 (50%)	0
2/3	1	0	15 (47%)	0
1	1	0	16 (50%)	0
0	0	1/3	17 (47%)	0
1/3	0	1/3	18 (50%)	0
2/3	0	1/3	19 (47%)	0
1	0	1/3	20 (50%)	0
0	1/3	1/3	21 (48%)	0
1/3	1/3	1/3	22 (50%)	0
2/3	1/3	1/3	23 (48%)	0
1	1/3	1/3	24 (50%)	0
0	2/3	1/3	25 (48%)	0

S2	S3	S4	OUT0 Divide (Duty Cycle ¹)	OUT0 Phase
1/3	2/3	1/3	26 (50%)	0
2/3	2/3	1/3	27 (48%)	0
1	2/3	1/3	28 (50%)	0
0	1	1/3	29 (48%)	0
1/3	1	1/3	30 (50%)	0
2/3	1	1/3	31 (48%)	0
1	1	1/3	32 (50%)	0
0	0	2/3	2 (50%)	1
1/3	0	2/3	4 (50%)	1
2/3	0	2/3	4 (50%)	2
1	0	2/3	4 (50%)	3
0	1/3	2/3	8 (50%)	1
1/3	1/3	2/3	8 (50%)	2
2/3	1/3	2/3	8 (50%)	3
1	1/3	2/3	8 (50%)	4
0	2/3	2/3	8 (50%)	5
1/3	2/3	2/3	8 (50%)	6
2/3	2/3	2/3	8 (50%)	7
1	2/3	2/3	16 (50%)	1
0	1	2/3	16 (50%)	2
1/3	1	2/3	16 (50%)	3
2/3	1	2/3	16 (50%)	4
1	1	2/3	16 (50%)	5
0	0	1	16 (50%)	6
1/3	0	1	16 (50%)	7
2/3	0	1	16 (50%)	8
1	0	1	16 (50%)	9
0	1/3	1	16 (50%)	10
1/3	1/3	1	16 (50%)	11
2/3	1/3	1	16 (50%)	12
1	1/3	1	16 (50%)	13
0	2/3	1	16 (50%)	14
1/3	2/3	1	16 (50%)	15
2/3	2/3	1	32 (50%)	1
1	2/3	1	32 (50%)	2
0	1	1	32 (50%)	3
1/3	1	1	32 (50%)	4
2/3	1	1	32 (50%)	5
1	1	1	Do not use	

¹ Duty cycle is the clock signal high time divided by the total period.

Table 13. S5, S6, and S7—OUT1

S5	S6	S7	OUT1 Divide (Duty Cycle ¹)	OUT1 Phase
0	0	0	1	0
1/3	0	0	2 (50%)	0
2/3	0	0	3 (33%)	0
1	0	0	4 (50%)	0
0	1/3	0	5 (40%)	0
1/3	1/3	0	6 (50%)	0
2/3	1/3	0	7 (43%)	0
1	1/3	0	8 (50%)	0
0	2/3	0	9 (44%)	0
1/3	2/3	0	10 (50%)	0
2/3	2/3	0	11 (45%)	0
1	2/3	0	12 (50%)	0
0	1	0	OUT1 OFF	
1/3	1	0	14 (50%)	0
2/3	1	0	15 (47%)	0
1	1	0	16 (50%)	0
0	0	1/3	17 (47%)	0
1/3	0	1/3	18 (50%)	0
2/3	0	1/3	19 (47%)	0
1	0	1/3	20 (50%)	0
0	1/3	1/3	21 (48%)	0
1/3	1/3	1/3	22 (50%)	0
2/3	1/3	1/3	23 (48%)	0
1	1/3	1/3	24 (50%)	0
0	2/3	1/3	25 (48%)	0
1/3	2/3	1/3	26 (50%)	0
2/3	2/3	1/3	27 (48%)	0
1	2/3	1/3	28 (50%)	0
0	1	1/3	29 (48%)	0
1/3	1	1/3	30 (50%)	0
2/3	1	1/3	31 (48%)	0
1	1	1/3	32 (50%)	0
0	0	2/3	2 (50%)	1
1/3	0	2/3	4 (50%)	1
2/3	0	2/3	4 (50%)	2
1	0	2/3	4 (50%)	3
0	1/3	2/3	8 (50%)	1
1/3	1/3	2/3	8 (50%)	2
2/3	1/3	2/3	8 (50%)	3
1	1/3	2/3	8 (50%)	4
0	2/3	2/3	8 (50%)	5
1/3	2/3	2/3	8 (50%)	6
2/3	2/3	2/3	8 (50%)	7
1	2/3	2/3	16 (50%)	1
0	1	2/3	16 (50%)	2
1/3	1	2/3	16 (50%)	3
2/3	1	2/3	16 (50%)	4
1	1	2/3	16 (50%)	5
0	0	1	16 (50%)	6

S5	S6	S7	OUT1 Divide (Duty Cycle ¹)	OUT1 Phase
1/3	0	1	16 (50%)	7
2/3	0	1	16 (50%)	8
1	0	1	16 (50%)	9
0	1/3	1	16 (50%)	10
1/3	1/3	1	16 (50%)	11
2/3	1/3	1	16 (50%)	12
1	1/3	1	16 (50%)	13
0	2/3	1	16 (50%)	14
1/3	2/3	1	16 (50%)	15
2/3	2/3	1	32 (50%)	1
1	2/3	1	32 (50%)	2
0	1	1	32 (50%)	3
1/3	1	1	32 (50%)	4
2/3	1	1	32 (50%)	5
1	1	1	Do not use	

¹ Duty cycle is the clock signal high time divided by the total period.

Table 14. S8—OUT0/OUT1 Phase (Delay) Select (Used with S9 to S10)

S8	OUT0	OUT1 (Delay if S0 ≠ 0)
0	No Phase	Phase (Delay)
1/3	Phase	No Phase
2/3	No Phase	Phase (Delay) (Start High)
1	Phase (Start High)	No Phase

Table 15. S9 and S10

S9	S10	OUT0 or OUT1 Phase (Depends on S8)	OUT1 Delay (S0 ≠ 0) (Depends on S8)
		Phase ¹	Fine Delay
0	0	0	0
1/3	0	1	1/16
2/3	0	2	1/8
1	0	3	3/16
0	1/3	4	1/4
1/3	1/3	5	5/16
2/3	1/3	6	3/8
1	1/3	7	7/16
0	2/3	8	1/2
1/3	2/3	9	9/16
2/3	2/3	10	5/8
1	2/3	11	11/16
0	1	12	3/4
1/3	1	13	13/16
2/3	1	14	7/8
1	1	15	15/16

¹ A phase > 0 in Table 12 or overrides the phase in Table 15.

DIVIDER PHASE OFFSET

The phase offset of OUT0 and OUT1 can be selected (see Table 12 to Table 15). This allows the relative phase of OUT0 and OUT1 to be set.

After a SYNC operation (see the Synchronization section), the phase offset word of each divider determines the number of input clock (CLK) cycles to wait before initiating a clock output edge. By giving each divider a different phase offset, output-to-output delays can be set in increments of the fast clock period, t_{CLK} .

Figure 29 shows four cases, each with the divider set to divide = 4. By incrementing the phase offset from 0 to 3, the output is offset from the initial edge by a multiple of t_{CLK} .

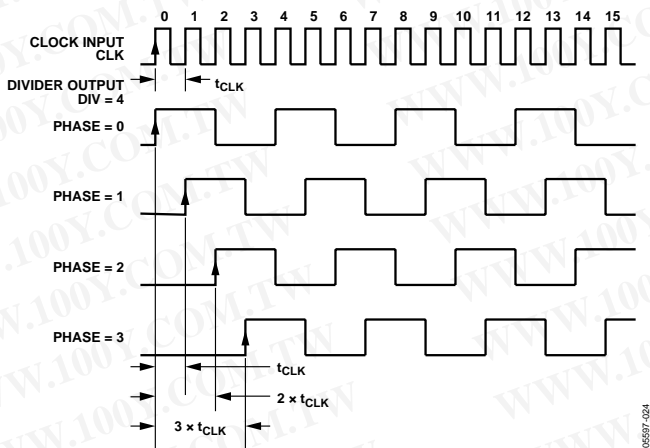

Figure 29. Phase Offset—Divider Set for Divide = 4, Phase Set from 0 to 2

For example:

$$CLK = 491.52 \text{ MHz}$$

$$t_{CLK} = 1/491.52 = 2.0345 \text{ ns}$$

For Divide = 4:

$$\text{Phase Offset } 0 = 0 \text{ ns}$$

$$\text{Phase Offset } 1 = 2.0345 \text{ ns}$$

$$\text{Phase Offset } 2 = 4.069 \text{ ns}$$

$$\text{Phase Offset } 3 = 6.104 \text{ ns}$$

The outputs can also be described as:

$$\text{Phase Offset } 0 = 0^\circ$$

$$\text{Phase Offset } 1 = 90^\circ$$

$$\text{Phase Offset } 2 = 180^\circ$$

$$\text{Phase Offset } 3 = 270^\circ$$

Setting the phase offset to Phase = 4 results in the same relative phase as Phase = 0° or 360°.

The resolution of the phase offset is set by the fast clock period (t_{CLK}) at CLK. The maximum unique phase offset is less than the divide ratio, up to a phase offset of 15.

Phase offsets can be related to degrees by calculating the phase step for a particular divide ratio:

$$\text{Phase Step} = 360^\circ / \text{Divide Ratio}$$

Using some of the same examples:

$$\text{Divide} = 4$$

$$\text{Phase Step} = 360^\circ / 4 = 90^\circ$$

$$\text{Unique Phase Offsets in Degrees Are Phase} = 0^\circ, 90^\circ, 180^\circ, 270^\circ$$

$$\text{Divide} = 9$$

$$\text{Phase Step} = 360^\circ / 9 = 40^\circ$$

$$\text{Unique Phase Offsets in Degrees Are Phase} = 0^\circ, 40^\circ, 80^\circ, 120^\circ, 160^\circ, 200^\circ, 240^\circ, 280^\circ, 320^\circ$$

DELAY BLOCK

OUT1 includes an analog delay element that gives variable time delays (ΔT) in the clock signal passing through that output.

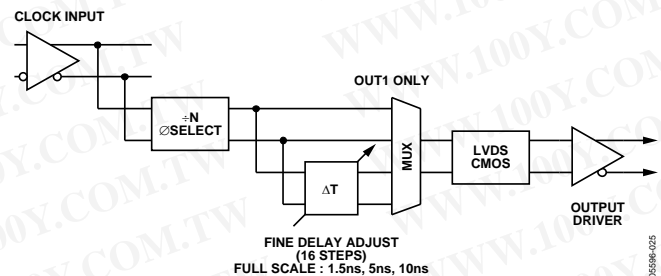

Figure 30. Analog Delay Block

The amount of delay that can be used is determined by the output frequency. The amount of delay is limited to less than one-half cycle of the clock period. For example, for a 10 MHz clock, the delay can extend to the full 10 ns maximum. However, for a 100 MHz clock, the maximum delay is less than 5 ns (or half of the period).

The AD9515 allows for the selection of three full-scale delays, 1.5 ns, 5 ns, and 10 ns, set by delay full scale (see Table 10). Each of these full-scale delays can be scaled by 16 fine adjustment values, which are set by the delay word (see Table 14 and Table 15).

The delay block adds some jitter to the output. This means that the delay function should be used primarily for clocking digital chips, such as FPGA, ASIC, DUC, and DDC, rather than for supplying a sample clock for data converters. The jitter is higher for longer full scales because the delay block uses a ramp and trip points to create the variable delay. A longer ramp means more noise has a chance of being introduced.

When the delay block is OFF (bypassed), it is also powered down.

OUTPUTS

The AD9515 offers three different output level choices: LVPECL, LVDS, and CMOS. OUT0/OUT0B offers an LVPECL differential output. The LVPECL differential voltage swing (V_{OD}) can be selected as either 400 mV or 790 mV (see Table 11).

OUT1/OUT1B can be selected as either an LVDS differential output or a pair of CMOS single-ended outputs. If selected as CMOS, OUT1 is a noninverted, single-ended output, and OUT1B is an inverted, single-ended output.

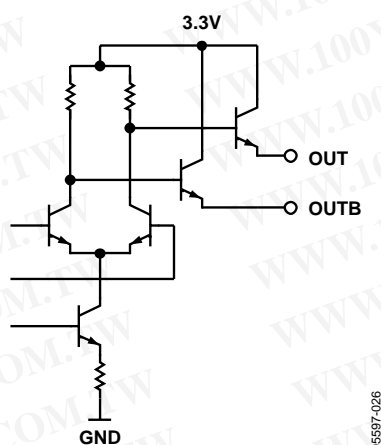

Figure 31. LVPECL Output Simplified Equivalent Circuit

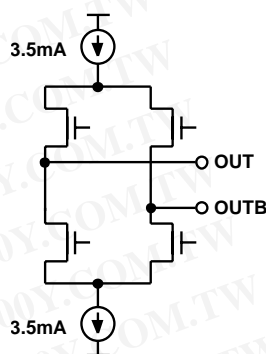

Figure 32. LVDS Output Simplified Equivalent Circuit

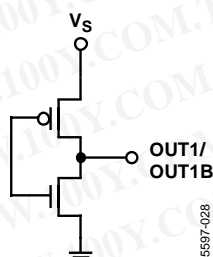

Figure 33. CMOS Equivalent Output Circuit

POWER SUPPLY

The AD9515 requires a $3.3\text{ V} \pm 5\%$ power supply for V_S . The tables in the Specifications section give the performance expected from the AD9515 with the power supply voltage within this range. In no case should the absolute maximum range of -0.3 V to $+3.6\text{ V}$, with respect to GND, be exceeded on Pin VS.

Good engineering practice should be followed in the layout of power supply traces and the ground plane of the PCB. The power supply should be bypassed on the PCB with adequate capacitance ($>10\text{ }\mu\text{F}$). The AD9515 should be bypassed with adequate capacitors ($0.1\text{ }\mu\text{F}$) at all power pins as close as possible to the part. The layout of the AD9515 evaluation board (AD9515/PCB) is a good example.

AD9515

Exposed Metal Paddle

The exposed metal paddle on the AD9515 package is an electrical connection, as well as a thermal enhancement. For the device to function properly, the paddle must be properly attached to ground (GND).

The exposed paddle of the AD9515 package must be soldered down. The AD9515 must dissipate heat through its exposed paddle. The PCB acts as a heat sink for the AD9515. The PCB attachment must provide a good thermal path to a larger heat dissipation area, such as a ground plane on the PCB. This requires a grid of vias from the top layer down to the ground plane (see Figure 34). The AD9515 evaluation board (AD9515/PCB) provides a good example of how the part should be attached to the PCB.

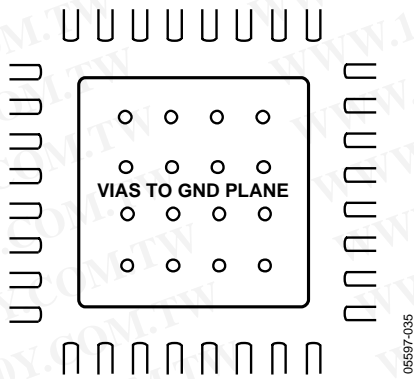

Figure 34. PCB Land for Attaching Exposed Paddle

POWER MANAGEMENT

In some cases, the AD9515 can be configured to use less power by turning off functions that are not being used.

The power-saving options include the following:

- A divider is powered down when set to divide = 1 (bypassed).
- Adjustable delay block on OUT1 is powered down when in off mode (S0 = 0).
- An unneeded output can be powered down (see Table 12 and Table 13). This also powers down the divider for that output.

APPLICATIONS

USING THE AD9515 OUTPUTS FOR ADC CLOCK APPLICATIONS

Any high speed, analog-to-digital converter (ADC) is extremely sensitive to the quality of the sampling clock provided by the user. An ADC can be thought of as a sampling mixer, and any noise, distortion, or timing jitter on the clock is combined with the desired signal at the A/D output. Clock integrity requirements scale with the analog input frequency and resolution, with higher analog input frequency applications at ≥ 14 -bit resolution being the most stringent. The theoretical SNR of an ADC is limited by the ADC resolution and the jitter on the sampling clock. Considering an ideal ADC of infinite resolution where the step size and quantization error can be ignored, the available SNR can be expressed approximately by

$$SNR = 20 \times \log \left[\frac{1}{2\pi f t_j} \right]$$

where f is the highest analog frequency being digitized.

t_j is the rms jitter on the sampling clock.

Figure 35 shows the required sampling clock jitter as a function of the analog frequency and effective number of bits (ENOB).

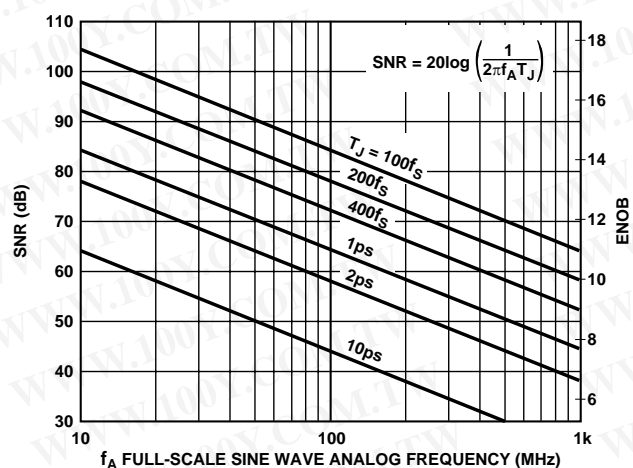

Figure 35. ENOB and SNR vs. Analog Input Frequency

See Application Notes AN-756 and AN-501 at www.analog.com.

Many high performance ADCs feature differential clock inputs to simplify the task of providing the required low jitter clock on a noisy PCB. (Distributing a single-ended clock on a noisy PCB can result in coupled noise on the sample clock. Differential distribution has inherent common-mode rejection that can provide superior clock performance in a noisy environment.) The AD9515 features both LVPECL and LVDS outputs that provide differential clock outputs, which enable clock solutions that maximize converter SNR performance. The input requirements of the ADC (differential or single-ended, logic level, termination) should be considered when selecting the best clocking/converter solution.

LVPECL CLOCK DISTRIBUTION

The low voltage, positive emitter-coupled, logic (LVPECL) outputs of the AD9515 provide the lowest jitter clock signals available from the AD9515. The LVPECL outputs (because they are open emitter) require a dc termination to bias the output transistors. The simplified equivalent circuit in Figure 31 shows the LVPECL output stage.

In most applications, a standard LVPECL far-end termination is recommended, as shown in Figure 36. The resistor network is designed to match the transmission line impedance (50Ω) and the switching threshold ($V_S - 1.3V$).

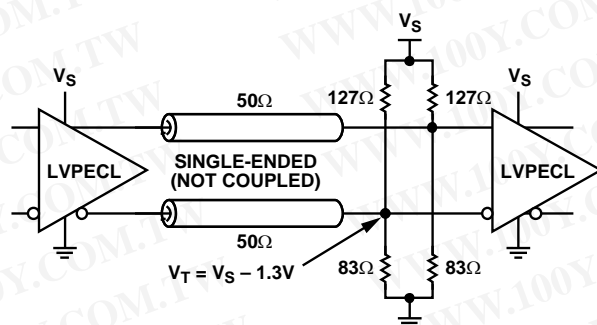

Figure 36. LVPECL Far-End Termination

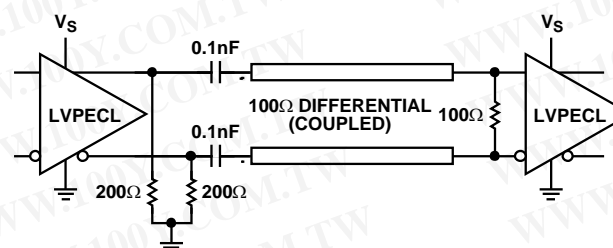

Figure 37. LVPECL with Parallel Transmission Line

LVDS CLOCK DISTRIBUTION

The AD9515 provides one clock output (OUT2) that is selectable as either CMOS or LVDS levels. Low voltage differential signaling (LVDS) is a differential output option for OUT2. LVDS uses a current mode output stage. The current is 3.5 mA, which yields 350 mV output swing across a 100 Ω resistor. The LVDS output meets or exceeds all ANSI/TIA/EIA-644 specifications.

A recommended termination circuit for the LVDS outputs is shown in Figure 38.

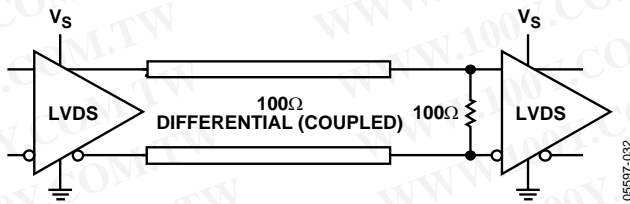

Figure 38. LVDS Output Termination

See Application Note AN-586 at www.analog.com for more information on LVDS.

CMOS CLOCK DISTRIBUTION

The AD9515 provides one output (OUT1) that is selectable as either CMOS or LVDS levels. When selected as CMOS, this output provides for driving devices requiring CMOS level logic at their clock inputs.

Whenever single-ended CMOS clocking is used, some of the following general guidelines should be used.

Point-to-point nets should be designed such that a driver has only one receiver on the net, if possible. This allows for simple termination schemes and minimizes ringing due to possible mismatched impedances on the net. Series termination at the source is generally required to provide transmission line matching and/or to reduce current transients at the driver. The value of the resistor is dependent on the board design and timing requirements (typically 10 Ω to 100 Ω is used). CMOS outputs are also limited in terms of the capacitive load or trace length that they can drive. Typically, trace lengths less than 3 inches are recommended to preserve signal rise/fall times and preserve signal integrity.

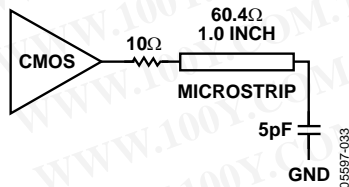

Figure 39. Series Termination of CMOS Output

Termination at the far end of the PCB trace is a second option. The CMOS outputs of the AD9515 do not supply enough current to provide a full voltage swing with a low impedance resistive, far-end termination, as shown in Figure 40. The far-end termination network should match the PCB trace impedance and provide the desired switching point. The reduced signal swing may still meet receiver input requirements in some applications. This can be useful when driving long trace lengths on less critical nets.

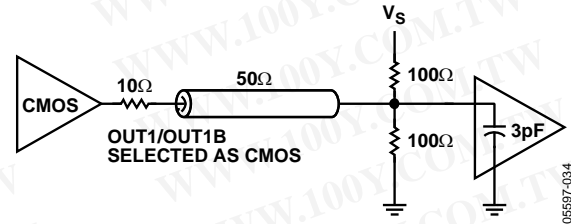

Figure 40. CMOS Output with Far-End Termination

Because of the limitations of single-ended CMOS clocking, consider using differential outputs when driving high speed signals over long traces. The AD9515 offers both LVPECL and LVDS outputs that are better suited for driving long traces where the inherent noise immunity of differential signaling provides superior performance for clocking converters.

SETUP PINS (S0 TO S10)

The setup pins that require a logic level of $\frac{1}{2} V_s$ (internal self-bias) should be tied together and bypassed to ground via a capacitor.

The setup pins that require a logic level of $\frac{2}{3} V_s$ should be tied together, along with the VREF pin, and bypassed to ground via a capacitor.

POWER AND GROUNDING CONSIDERATIONS AND POWER SUPPLY REJECTION

Many applications seek high speed and performance under less than ideal operating conditions. In these application circuits, the implementation and construction of the PCB is as important as the circuit design. Proper RF techniques must be used for device selection, placement, and routing, as well as power supply bypassing and grounding to ensure optimum performance.

PHASE NOISE AND JITTER MEASUREMENT SETUPS

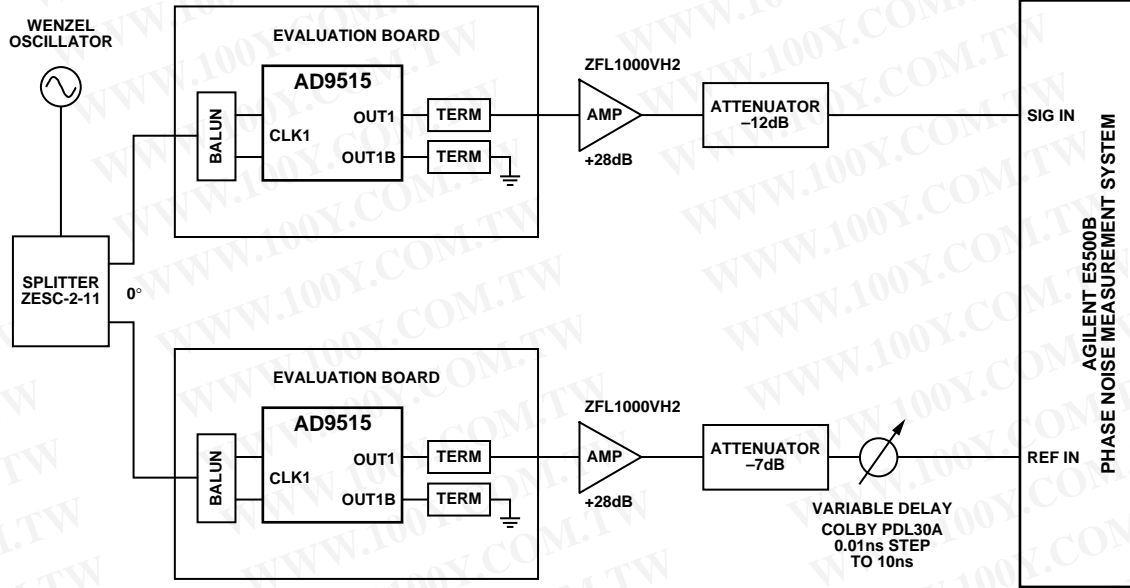

Figure 41. Additive Phase Noise Measurement Configuration

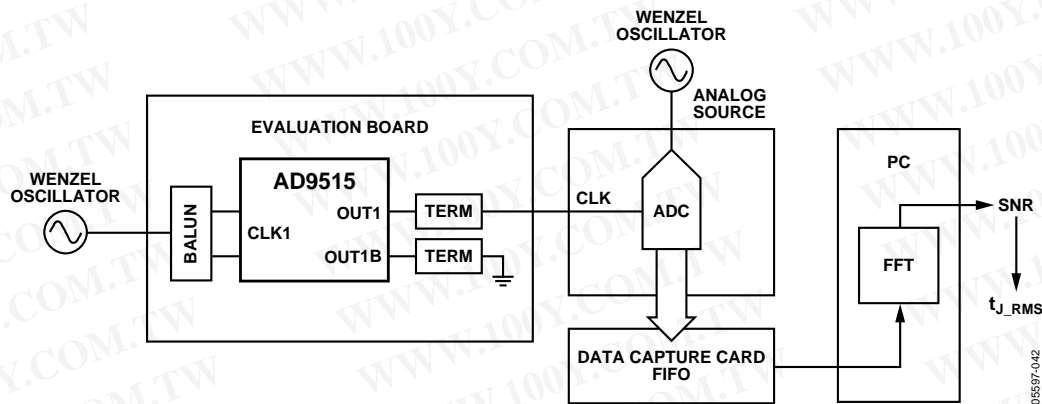

Figure 42. Jitter Determination by Measuring SNR of ADC

$$t_{J_RMS} = \sqrt{\frac{\left[\frac{V_{A_RMS}}{SNR} \right]^2 - \left(SND \times \sqrt{BW} \right)^2 - \left(\theta_{QUANTIZATION}^2 + \theta_{THERMAL}^2 + \theta_{DNL}^2 \right)}{\left[2\pi \times f_A \times V_{A_PK} \right]^2}}$$

where:

t_{J_RMS} is the rms time jitter.

SNR is the signal-to-noise ratio.

SND is the source noise density in nV/√Hz.

BW is the SND filter bandwidth.

V_A is the analog source voltage.

f_A is the analog frequency.

The θ terms are the quantization, thermal, and DNL errors.

AD9515

OUTLINE DIMENSIONS

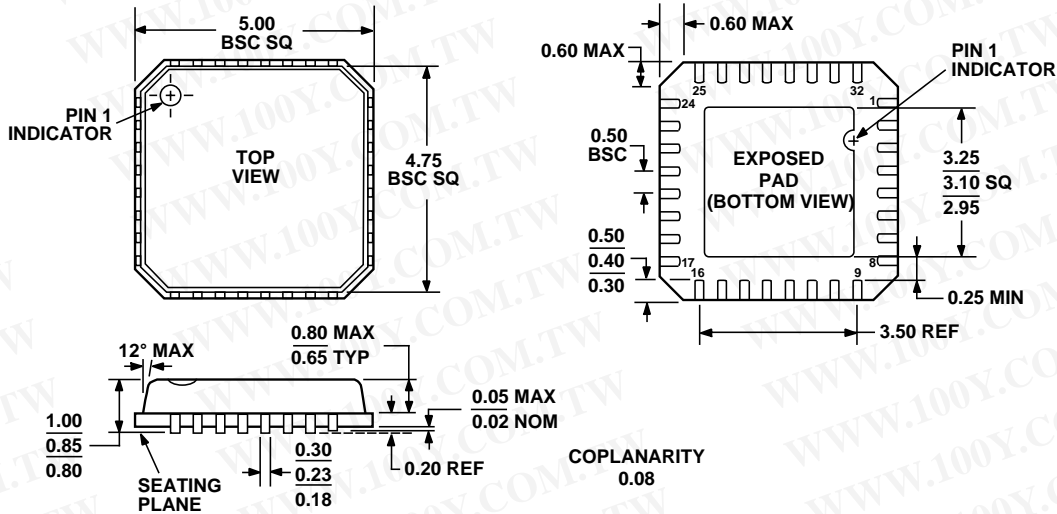

COMPLIANT TO JEDEC STANDARDS MO-220-VHHD-2

Figure 43. 32-Lead Lead Frame Chip Scale Package [LFCSP_VQ]
 5 mm x 5 mm Body, Very Thin Quad (CP-32-2)
 Dimensions shown in millimeters

ORDERING GUIDE

Model	Temperature Range	Package Description	Package Option
AD9515BCPZ ¹	-40°C to +85°C	32-Lead Lead Frame Chip Scale Package (LFCSP_VQ)	CP-32-2
AD9515BCPZ-REEL7 ¹	-40°C to +85°C	32-Lead Lead Frame Chip Scale Package (LFCSP_VQ)	CP-32-2
AD9515/PCB		Evaluation Board	

¹ Z = Pb-free part.

勝特力材料 886-3-5753170
 勝特力电子(上海) 86-21-34970699
 勝特力电子(深圳) 86-755-83298787
[Http://www.100y.com.tw](http://www.100y.com.tw)