

Half-Duplex RS-485/RS-422 Transceivers in μ DFN

General Description

The MAX13485E/MAX13486E +5V, half-duplex, ± 15 kV ESD-protected RS-485 transceivers feature one driver and one receiver. These devices include fail-safe circuitry, guaranteeing a logic-high receiver output when receiver inputs are open or shorted. The receiver outputs a logic-high if all transmitters on a terminated bus are disabled (high impedance). The MAX13485E/MAX13486E include a hot-swap capability to eliminate false transitions on the bus during power-up or live-insertion.

The MAX13485E features reduced slew-rate drivers that minimize EMI and reduce reflections caused by improperly terminated cables, allowing error-free transmission up to 500kbps. The MAX13486E driver slew rate is not limited, allowing transmit speeds up to 16Mbps.

The MAX13485E/MAX13486E feature a 1/4-unit load receiver input impedance, allowing up to 128 transceivers on the bus. These devices are intended for half-duplex communications. All driver outputs are protected to ± 15 kV ESD using the Human Body Model. The MAX13485E/MAX13486E are available in 8-pin SO and space-saving 8-pin μ DFN packages. The devices operate over the extended -40°C to $+85^{\circ}\text{C}$ temperature range.

Applications

Utility Meters
 Industrial Controls
 Industrial Motor Drives
 Automated HVAC Systems

Features

- ◆ +5V Operation
- ◆ True Fail-Safe Receiver While Maintaining EIA/TIA-485 Compatibility
- ◆ Hot-Swappable for Telecom Applications
- ◆ Enhanced Slew-Rate Limiting Facilitates Error-Free Data Transmission (MAX13485E)
- ◆ High-Speed Version (MAX13486E) Allows for Transmission Speeds Up to 16Mbps
- ◆ Extended ESD Protection for RS-485/RS-422 I/O Pins ± 15 kV Using Human Body Model
- ◆ 1/4 Unit Load, Allowing Up to 128 Transceivers on the Bus
- ◆ Available in Space-Saving 8-Pin μ DFN or Industry Standard 8-Pin SO Packages

Ordering Information/ Selector Guide

PART	PIN-PACKAGE	SLEW-RATE LIMITED	PKG CODE
MAX13485EELA+T	8 μ DFN	Yes	L822-1
MAX13485EESA+	8 SO	Yes	S8-2
MAX13486EELA+T	8 μ DFN	No	L822-1
MAX13486EESA+	8 SO	No	S8-2

+Denotes a lead-free package.

Note: All devices are specified over the -40°C to $+85^{\circ}\text{C}$ operating temperature range.

Pin Configurations

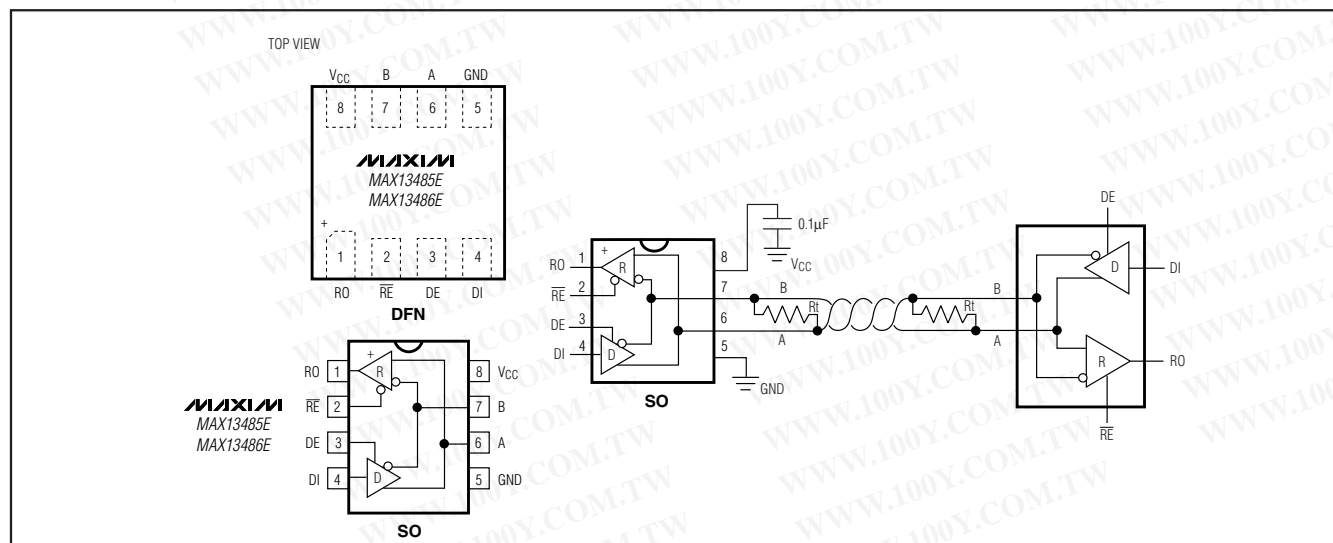

Half-Duplex RS-485/RS-422 Transceivers in μ DFN

ABSOLUTE MAXIMUM RATINGS

(All voltages referenced to GND.)

V_{CC}	+6V
DE, \overline{RE} , DI	-0.3V to +6V
A, B	-8V to 13V
Short-Circuit Duration (RO, A, B) to GND	Continuous
Continuous Power Dissipation ($T_A = +70^\circ\text{C}$)	
8-Pin SO (derate 5.9mW/ $^\circ\text{C}$ above $+70^\circ\text{C}$)	471mW
8-Pin μ DFN (derate 4.8mW/ $^\circ\text{C}$ above $+70^\circ\text{C}$)	380.6mW

Operating Temperature Range	-40 $^\circ\text{C}$ to +85 $^\circ\text{C}$
Junction Temperature	+150 $^\circ\text{C}$
Storage Temperature Range	-65 $^\circ\text{C}$ to +150 $^\circ\text{C}$
Lead Temperature (soldering, 10s)	+300 $^\circ\text{C}$

Stresses beyond those listed under "Absolute Maximum Ratings" may cause permanent damage to the device. These are stress ratings only, and functional operation of the device at these or any other conditions beyond those indicated in the operational sections of the specifications is not implied. Exposure to absolute maximum rating conditions for extended periods may affect device reliability.

ELECTRICAL CHARACTERISTICS

($V_{CC} = +5V \pm 5\%$, $T_A = T_{MIN}$ to T_{MAX} , unless otherwise noted. Typical values are at $V_{CC} = +5V$ and $T_A = +25^\circ\text{C}$.) (Notes 1, 2)

PARAMETER	SYMBOL	CONDITIONS	MIN	TYP	MAX	UNITS
DRIVER						
Differential Driver Output	V_{OD}	$R_{DIFF} = 100\Omega$, Figure 1	2.0		V_{CC}	V
		$R_{DIFF} = 54\Omega$, Figure 1	1.5			
		No load			V_{CC}	
Change in Magnitude of Differential Output Voltage	ΔV_{OD}	$R_{DIFF} = 100\Omega$ or 54Ω , Figure 1 (Note 3)			0.2	V
Driver Common-Mode Output Voltage	V_{OC}	$R_{DIFF} = 100\Omega$ or 54Ω , Figure 1		$\frac{V_{CC}}{2}$	3	V
Change in Magnitude of Common-Mode Voltage	ΔV_{OC}	$R_{DIFF} = 100\Omega$ or 54Ω , Figure 1 (Note 3)			0.2	V
Input-High Voltage	V_{IH}	DI, DE, \overline{RE}	2.0			V
Input-Low Voltage	V_{IL}	DI, DE, \overline{RE}			0.8	V
Input Current	I_{IN}	DI, DE, \overline{RE}			± 1	μA
Driver Short-Circuit Output Current (Note 4)	I_{OSD}	$0V \leq V_{OUT} \leq +12V$	+50		+250	mA
		$-7V \leq V_{OUT} \leq 0V$	-250		-50	
Driver Short-Circuit Foldback Output Current Note 3)	I_{OSDF}	$(V_{CC} - 1V) \leq V_{OUT} \leq +12V$	20			mA
		$-7V \leq V_{OUT} \leq 0V$			-20	
RECEIVER						
Input Current (A and B)	$I_{A, B}$	DE = GND, $V_{CC} = \text{GND}$ or +5V	$V_{IN} = +12V$		250	μA
			$V_{IN} = -7V$		-200	
Receiver-Differential-Threshold Voltage	V_{TH}	$-7V \leq V_{CM} \leq +12V$	-200		-50	mV
Receiver Input Hysteresis	ΔV_{TH}	$V_A + V_B = 0V$		25		mV
Output-High Voltage	V_{OH}	$I_O = -1.6\text{mA}$, $V_A - V_B > V_{TH}$	$V_{CC} - 1.5$			V

Half-Duplex RS-485/RS-422 Transceivers in μ DFN

MAX13485E/MAX13486E

ELECTRICAL CHARACTERISTICS (continued)

($V_{CC} = +5V \pm 5\%$, $T_A = T_{MIN}$ to T_{MAX} , unless otherwise noted. Typical values are at $V_{CC} = +5V$ and $T_A = +25^\circ C$.) (Notes 1, 2)

PARAMETER	SYMBOL	CONDITIONS	MIN	TYP	MAX	UNITS
Output-Low Voltage	V_{OL}	$I_O = 1mA$, $V_A - V_B < -V_{TH}$			0.4	V
Tri-State Output Current at Receiver	I_{OZR}	$0V \leq V_O \leq V_{CC}$			± 1	μA
Receiver Input Resistance	R_{IN}	$-7V \leq V_{CM} \leq +12V$	48			$k\Omega$
Receiver-Output Short-Circuit Current	I_{OSR}	$0V \leq V_{RO} \leq V_{CC}$	± 7		± 95	mA
POWER SUPPLY						
Supply Voltage	V_{CC}		4.75		5.25	V
Supply Current	I_{CC}	$DE = 1$, $\overline{RE} = 0$, no load			4.5	mA
Shutdown Supply Current	I_{SHDN}	$DE = 0$, $\overline{RE} = 1$			10	μA
ESD PROTECTION						
ESD Protection (A, B)		Air Gap Discharge IEC61000-4-2 (MAX13485E)		± 15		kV
		Human Body Model		± 15		
ESD Protection (All Other Pins)		Human Body Model		± 2		kV

SWITCHING CHARACTERISTICS—MAX13485E

($V_{CC} = +5V \pm 5\%$, $T_A = T_{MIN}$ to T_{MAX} , unless otherwise noted. Typical values are at $V_{CC} = +5V$ and $T_A = +25^\circ C$.) (Note 1)

PARAMETER	SYMBOL	CONDITIONS	MIN	TYP	MAX	UNITS
DRIVER						
Driver Propagation Delay	t_{DPLH}	$R_{DIFF} = 54\Omega$, $C_L = 50pF$, Figures 2 and 3	200		1000	ns
	t_{DPLH}		200		1000	
Driver-Differential Output Rise or Fall Time	t_{HL}	$R_{DIFF} = 54\Omega$, $C_L = 50pF$, Figures 2 and 3	250		900	ns
	t_{LH}		250		900	
Driver-Differential Output Skew $ t_{DPLH} - t_{DPLH} $	t_{DSKEW}	$R_{DIFF} = 54\Omega$, $C_L = 50pF$, Figures 2 and 3			140	ns
Maximum Data Rate			500			kbps
Driver Enable to Output High	t_{DZH}	Figures 4 and 5			2500	ns
Driver Enable to Output Low	t_{DZL}	Figures 4 and 5			2500	ns
Driver Disable Time from High	t_{DHZ}	Figures 4 and 5			100	ns
Driver Disable Time from Low	t_{DLZ}	Figures 4 and 5			100	ns
Driver Enable from Shutdown to Output High	$t_{DZH(SHDN)}$	Figures 4 and 5			5500	ns
Driver Enable from Shutdown to Output Low	$t_{DZL(SHDN)}$	Figures 4 and 5			5500	ns
Time to Shutdown	t_{SHDN}		50	340	700	ns
RECEIVER						
Receiver Propagation Delay	t_{RPLH}	$C_L = 15pF$, Figures 6 and 7			80	ns
	t_{RPHL}				80	
Receiver Output Skew	t_{RSKEW}	$C_L = 15pF$, Figure 7			13	ns
Maximum Data Rate			500			kbps

Half-Duplex RS-485/RS-422 Transceivers in μ DFN

SWITCHING CHARACTERISTICS—MAX13485E (continued)

($V_{CC} = +5V \pm 5\%$, $T_A = T_{MIN}$ to T_{MAX} , unless otherwise noted. Typical values are at $V_{CC} = +5V$ and $T_A = +25^\circ C$.) (Note 1)

PARAMETER	SYMBOL	CONDITIONS	MIN	TYP	MAX	UNITS
Receiver Enable to Output High	t _{RZH}	Figure 8			50	ns
Receiver Enable to Output Low	t _{RZL}	Figure 8			50	ns
Receiver Disable Time from High	t _{RHZ}	Figure 8			50	ns
Receiver Disable Time from Low	t _{RLZ}	Figure 8			50	ns
Receiver Enable from Shutdown to Output High	t _{RZH(SHDN)}	Figure 8			2200	ns
Receiver Enable from Shutdown to Output Low	t _{RZL(SHDN)}	Figure 8			2200	ns
Time to Shutdown	t _{SHDN}		50	340	700	ns

SWITCHING CHARACTERISTICS—MAX13486E

($V_{CC} = +5V \pm 5\%$, $T_A = T_{MIN}$ to T_{MAX} , unless otherwise noted. Typical values are at $V_{CC} = +5V$ and $T_A = +25^\circ C$.) (Note 1)

PARAMETER	SYMBOL	CONDITIONS	MIN	TYP	MAX	UNITS
DRIVER						
Driver Propagation Delay	t _{DPLH}	R _{DIFF} = 54 Ω , C _L = 50pF, Figures 2 and 3			50	ns
	t _{DPHL}				50	
Driver Differential Output Rise or Fall Time	t _{HL}	R _{DIFF} = 54 Ω , C _L = 50pF, Figures 2 and 3			15	ns
	t _{LH}				15	
Differential Driver Output Skew (t _{DPLH} - t _{DPHL})	t _{DSKEW}	R _{DIFF} = 54 Ω , C _L = 50pF, Figures 2 and 3			8	ns
Maximum Data Rate			16			Mbps
Driver Enable to Output High	t _{DZH}	Figures 4 and 5			50	ns
Driver Enable to Output Low	t _{DZL}	Figures 4 and 5			50	ns
Driver Disable Time from High	t _{DHZ}	Figures 4 and 5			50	ns
Driver Disable Time from Low	t _{DLZ}	Figures 4 and 5			50	ns
Driver Enable from Shutdown to Output High	t _{DZH(SHDN)}	Figures 4 and 5			2200	ns
Driver Enable from Shutdown to Output Low	t _{DZL(SHDN)}	Figures 4 and 5			2200	ns
Time to Shutdown	t _{SHDN}		50	340	700	ns
RECEIVER						
Receiver Propagation Delay	t _{RPLH}	C _L = 15pF, Figures 6 and 7			80	ns
	t _{RPHL}				80	
Receiver Output Skew	t _{RSKEW}	C _L = 15pF, Figure 7			13	ns
Maximum Data Rate			16			Mbps

Half-Duplex RS-485/RS-422 Transceivers in μ DFN

SWITCHING CHARACTERISTICS—MAX13486E (continued)

($V_{CC} = +5V \pm 5\%$, $T_A = T_{MIN}$ to T_{MAX} , unless otherwise noted. Typical values are at $V_{CC} = +5V$ and $T_A = +25^\circ C$.) (Note 1)

PARAMETER	SYMBOL	CONDITIONS	MIN	TYP	MAX	UNITS
Receiver Enable to Output High	t_{RZH}	Figure 8			50	ns
Receiver Enable to Output Low	t_{RZL}	Figure 8			50	ns
Receiver Disable Time from High	t_{RHZ}	Figure 8			50	ns
Receiver Disable Time from Low	t_{RLZ}	Figure 8			50	ns
Receiver Enable from Shutdown to Output High	$t_{RZH}(SHDN)$	Figure 8			2200	ns
Receiver Enable from Shutdown to Output Low	$t_{RZL}(SHDN)$	Figure 8			2200	ns
Time to Shutdown	t_{SHDN}		50	340	700	ns

Note 1: μ DFN devices production tested at $+25^\circ C$. Overtemperature limits are generated by design.

Note 2: All currents into the device are positive. All currents out of the device are negative. All voltages referred to device ground, unless otherwise noted.

Note 3: ΔV_{OD} and ΔV_{OC} are the changes in V_{OD} and V_{OC} when the DI input changes states.

Note 4: The short-circuit output current applied to peak current just prior to foldback current limiting. The short-circuit foldback output current applies during current limiting to allow a recovery from bus contention.

MAX13485E/MAX13486E

Typical Operating Characteristics

($V_{CC} = +5V$, $T_A = +25^\circ C$, unless otherwise noted.)

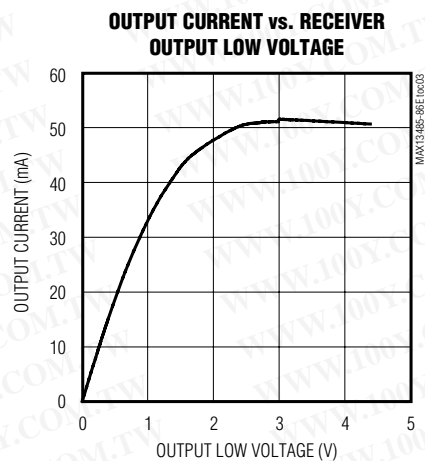
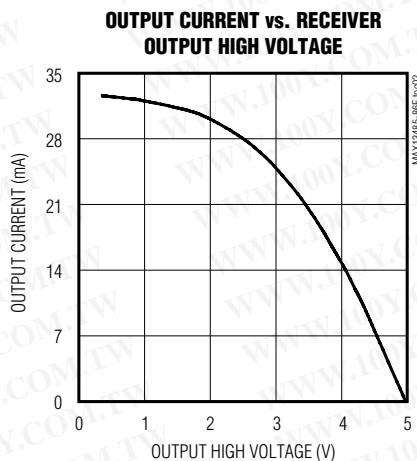
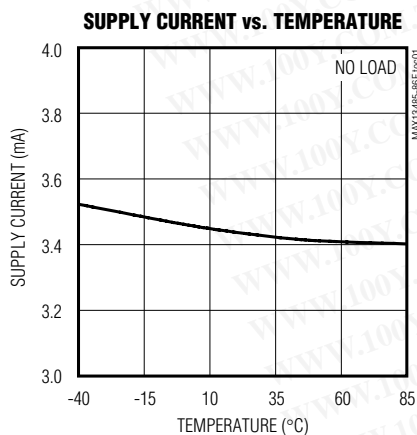

Half-Duplex RS-485/RS-422 Transceivers in μ DFN

Typical Operating Characteristics (continued)

($V_{CC} = +5V$, $T_A = +25^\circ C$, unless otherwise noted.)

RECEIVER OUTPUT HIGH VOLTAGE vs. TEMPERATURE

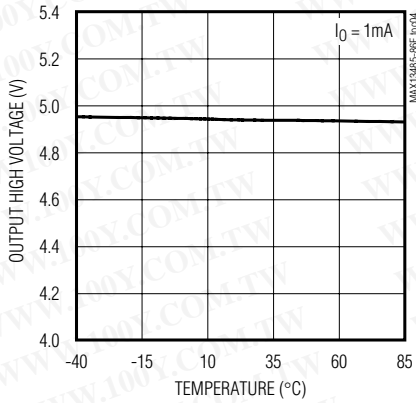

RECEIVER OUTPUT LOW VOLTAGE vs. TEMPERATURE

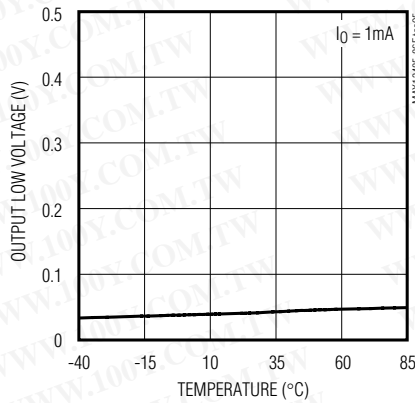

DIFFERENTIAL OUTPUT CURRENT vs. DIFFERENTIAL OUTPUT VOLTAGE

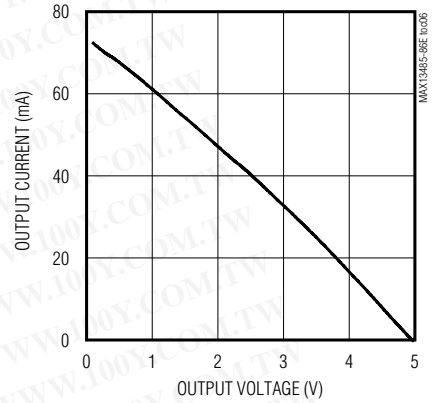

DRIVER-DIFFERENTIAL OUTPUT VOLTAGE vs. TEMPERATURE

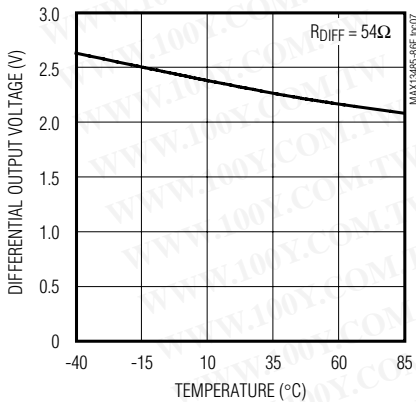

OUTPUT CURRENT vs. TRANSMITTER OUTPUT HIGH VOLTAGE

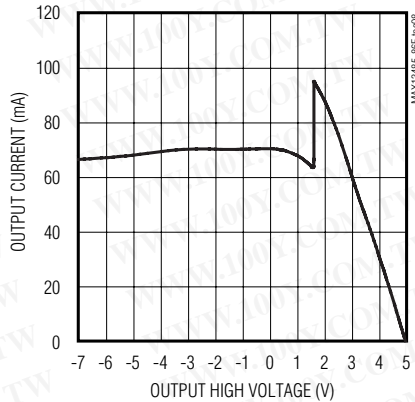

OUTPUT CURRENT vs. TRANSMITTER OUTPUT LOW VOLTAGE

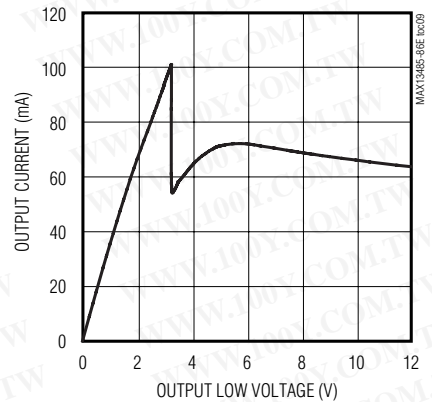

SHUTDOWN CURRENT vs. TEMPERATURE

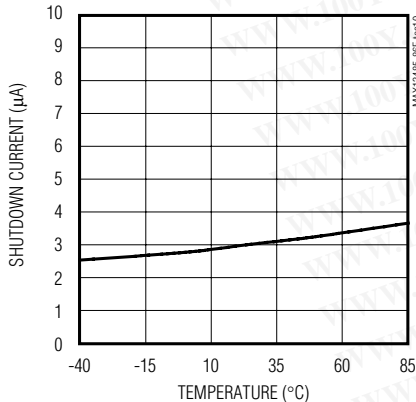

DRIVER PROPAGATION vs. TEMPERATURE (MAX13485E)

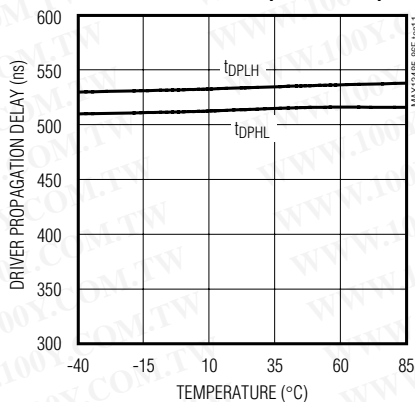

DRIVER PROPAGATION DELAY vs. TEMPERATURE (MAX13486E)

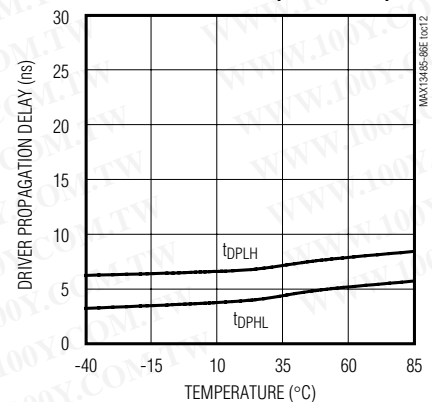

Half-Duplex RS-485/RS-422 Transceivers in μ DFN

Typical Operating Characteristics (continued)

($V_{CC} = +5V$, $T_A = +25^\circ C$, unless otherwise noted.)

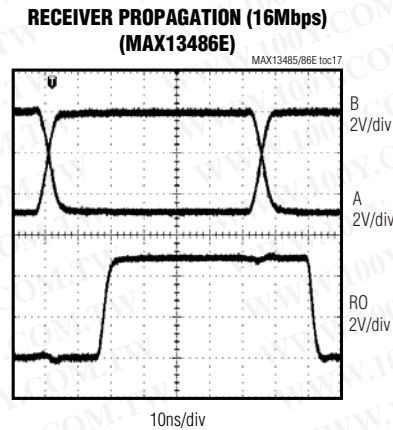
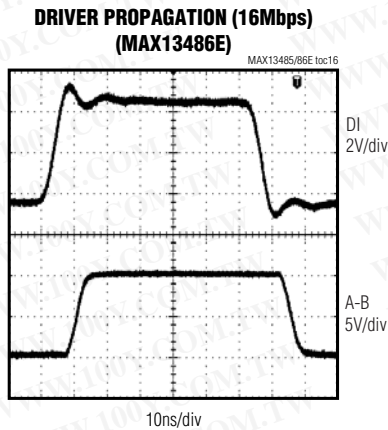
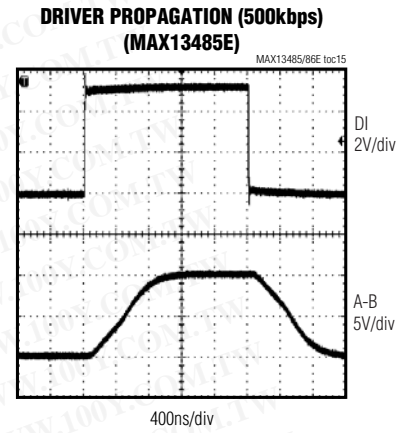
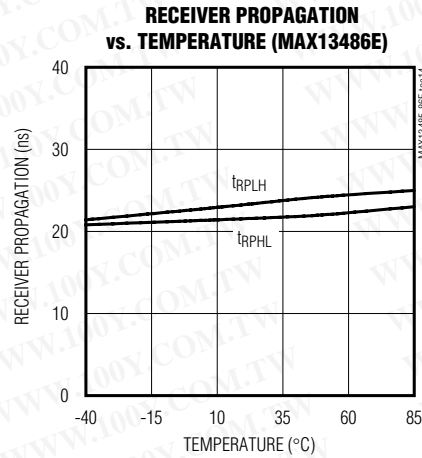
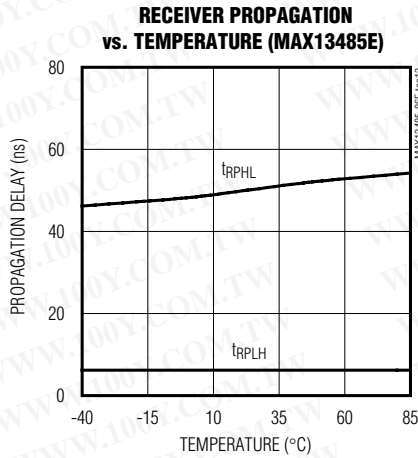

MAX13485E/MAX13486E

Half-Duplex RS-485/RS-422 Transceivers in μ DFN

Test Circuits and Waveforms

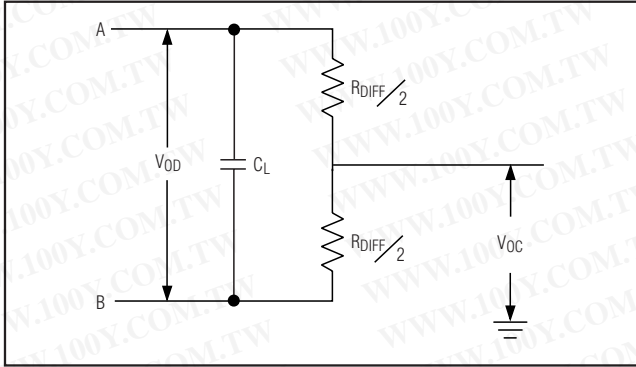

Figure 1. Driver DC Test Load

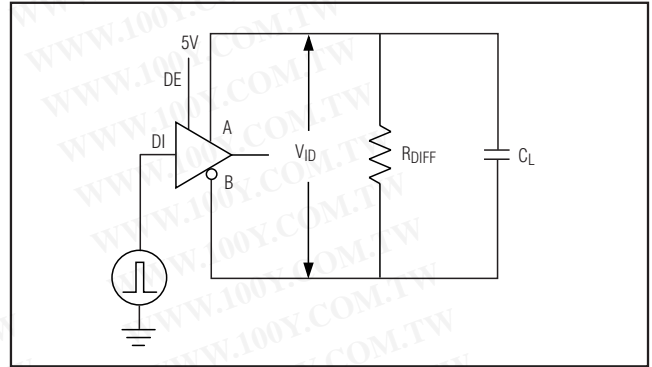

Figure 2. Driver Timing Test Circuit

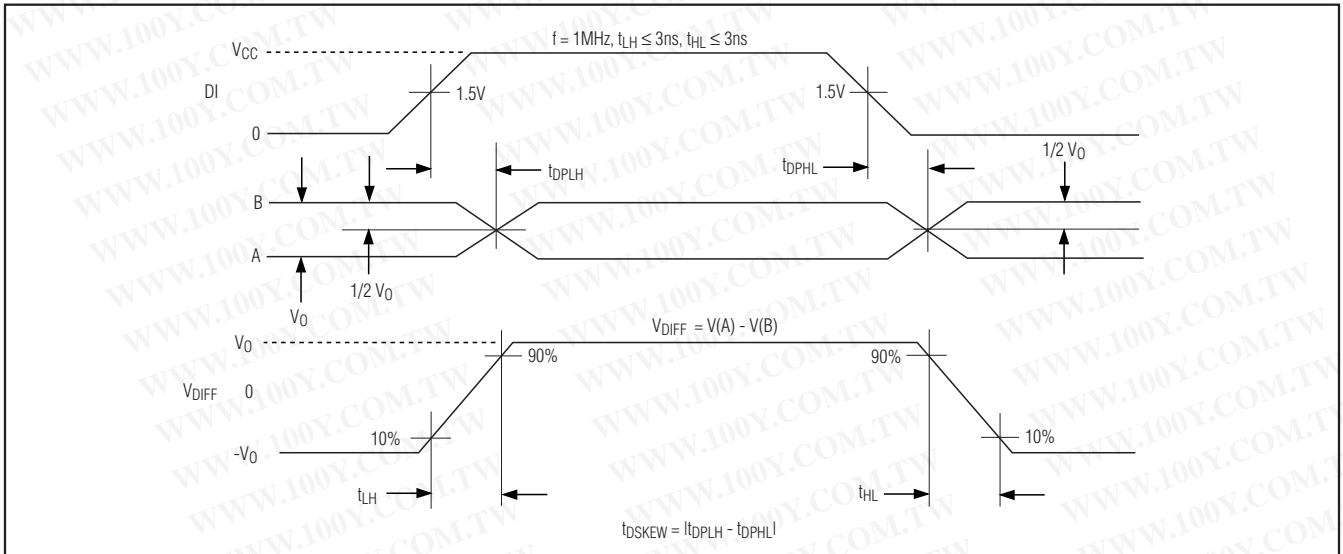

Figure 3. Driver Propagation Delays

Half-Duplex RS-485/RS-422 Transceivers in μ DFN

Test Circuits and Waveforms (continued)

MAX13485E/MAX13486E

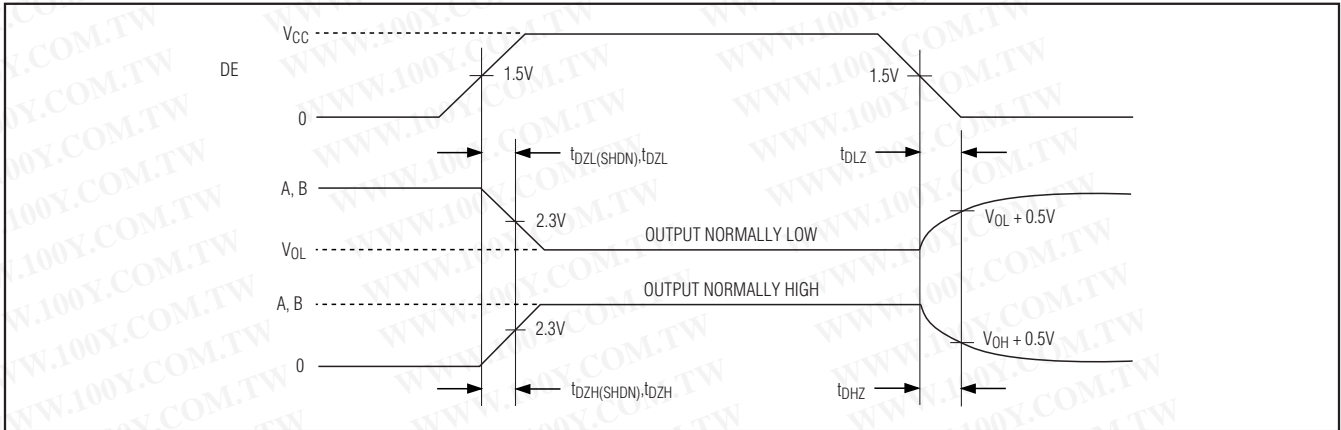

Figure 4. Driver Enable and Disable Times

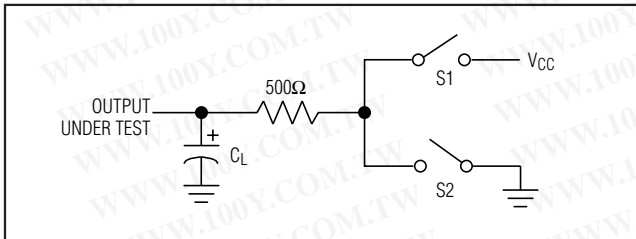

Figure 5. Driver-Enable and -Disable-Timing Test Load

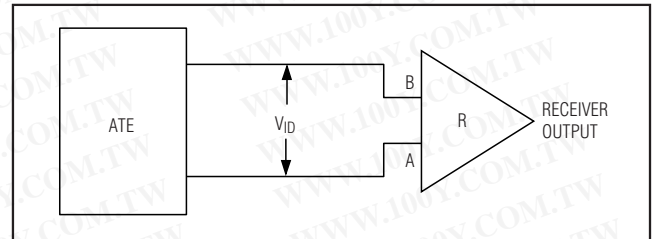

Figure 6. Receiver Propagation Delay Test Circuit

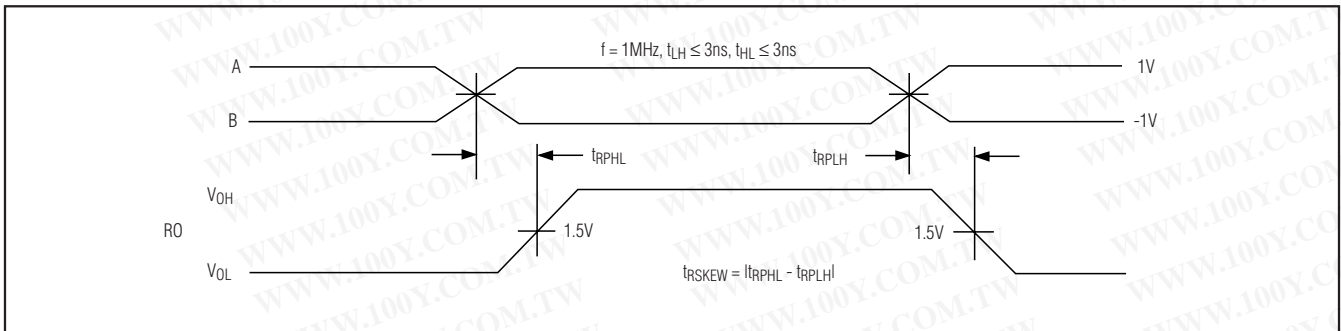

Figure 7. Receiver Propagation Delays

Half-Duplex RS-485/RS-422 Transceivers in μ DFN

Pin Description

PIN	NAME	FUNCTION
1	RO	Receiver Output
2	\overline{RE}	Receiver Output Enable. Drive \overline{RE} low to enable RO. RO is high impedance when \overline{RE} is high. Drive \overline{RE} high and DE low to enter low-power shutdown mode. \overline{RE} is a hot-swap input (see the <i>Hot-Swap Capability</i> section for more details).
3	DE	Driver Output Enable. Drive DE high to enable the driver outputs. These outputs are high-impedance when DE is low. Drive \overline{RE} high and DE low to enter low-power shutdown mode. DE is a hot-swap input (see the <i>Hot-Swap Capability</i> section for more details).
4	DI	Driver Input. Drive DI low to force noninverting output low and inverting output high. Drive DI high to force noninverting output high and inverting output low (see the <i>Function Tables</i>).
5	GND	Ground
6	A	Noninverting Receiver Input and Noninverting Driver Output
7	B	Inverting Receiver Input and Inverting Driver Output
8	V _{CC}	Positive Supply, V _{CC} = +5V \pm 5%. Bypass V _{CC} to GND with a 0.1 μ F capacitor.

Function Tables

TRANSMITTING				
INPUT			OUTPUT	
\overline{RE}	DE	DI	B	A
X	1	1	0	1
X	1	0	1	0
0	0	X	HIGH IMPEDANCE	HIGH IMPEDANCE
1	0	X	SHUTDOWN	

RECEIVING			
INPUT			OUTPUT
\overline{RE}	DE	A-B	RO
0	X	$\geq -50\text{mV}$	1
0	X	$\leq -200\text{mV}$	0
0	X	OPEN/SHORT	1
1	1	X	HIGH IMPEDANCE
1	0	X	SHUTDOWN

X = Don't care, shutdown mode, driver, and receiver outputs are in high impedance.

Half-Duplex RS-485/RS-422 Transceivers in μ DFN

Test Circuits and Waveforms (continued)

MAX13485E/MAX13486E

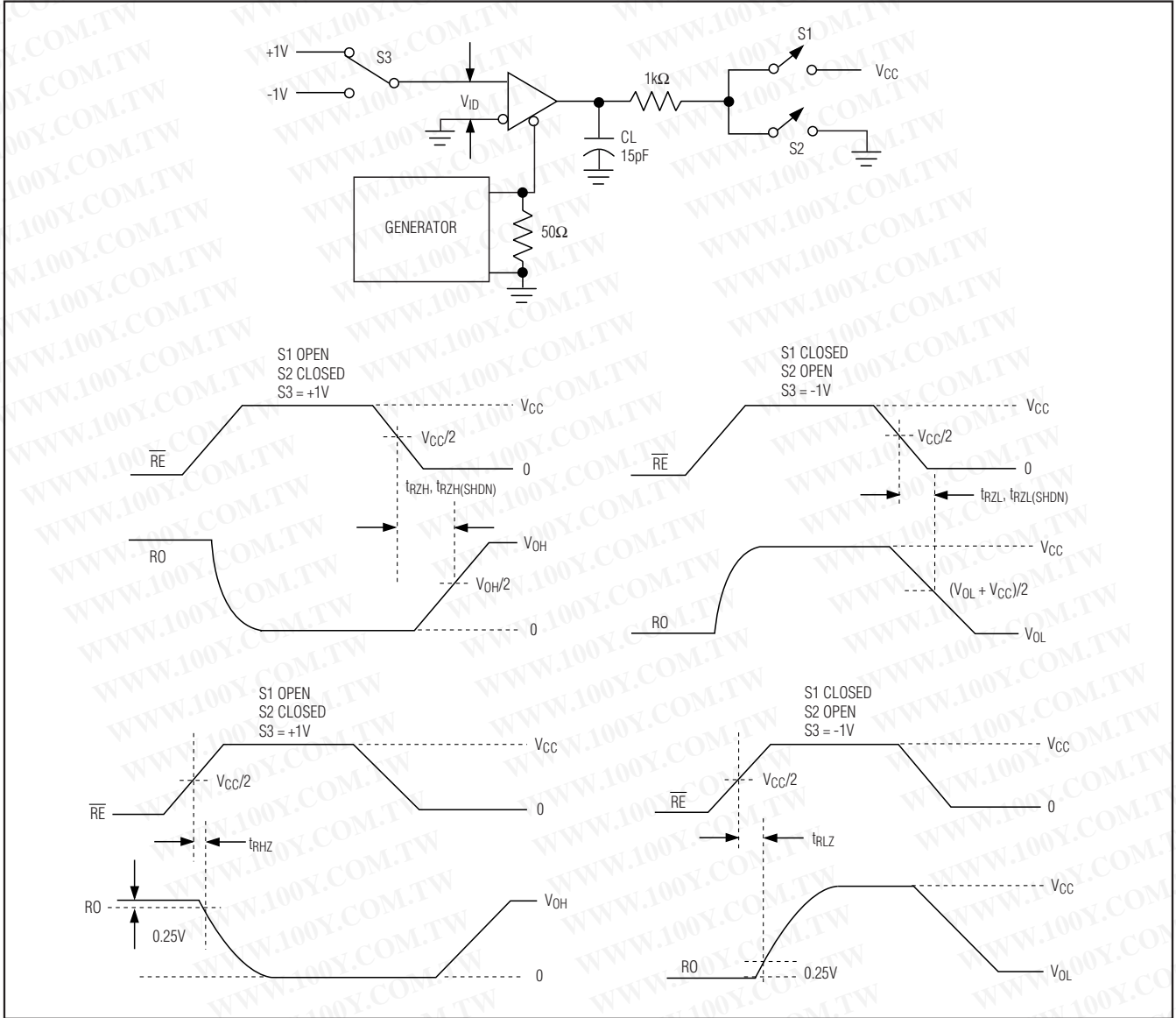

Figure 8. Receiver Enable and Disable Times

Half-Duplex RS-485/RS-422 Transceivers in μ DFN

Detailed Description

The MAX13485E/MAX13486E half-duplex, high-speed transceivers for RS-485/RS-422 communication contain one driver and one receiver. These devices feature fail-safe circuitry that guarantees a logic-high receiver output when receiver inputs are open or shorted, or when they are connected to a terminated transmission line with all drivers disabled (see the *Fail-Safe* section). The MAX13485E/MAX13486E also feature a hot-swap capability allowing line insertion without erroneous data transfer (see the *Hot-Swap Capability* section). The MAX13485E features reduced slew-rate drivers that minimize EMI and reduce reflections caused by improperly terminated cables, allowing error-free transmission up to 500kbps. The MAX13486E driver slew rate is not limited, making transmit speeds up to 16Mbps possible.

Fail-Safe

The MAX13485E/MAX13486E guarantee a logic-high receiver output when the receiver inputs are shorted or open, or when they are connected to a terminated transmission line with all drivers disabled. This is done by setting the receiver input threshold between -50mV and -200mV . If the differential receiver input voltage ($A - B$) is greater than or equal to -50mV , RO is logic-high. If ($A - B$) is less than or equal to -200mV , RO is logic-low. In the case of a terminated bus with all transmitters disabled, the receiver's differential input voltage is pulled to 0V by the termination. With the receiver thresholds of the MAX13485E/MAX13486E, this results in a logic-high with a 50mV minimum noise margin. Unlike previous fail-safe devices, the -50mV to -200mV threshold complies with the $\pm 200\text{mV}$ EIA/TIA-485 standard.

Hot-Swap Capability

Hot-Swap Inputs

When circuit boards are inserted into a hot or powered backplane, differential disturbances to the data bus can lead to data errors. Upon initial circuit-board insertion, the data communication processor undergoes its own power-up sequence. During this period, the processor's logic-output drivers are high impedance and are unable to drive the DE and $\overline{\text{RE}}$ inputs of these devices to a defined logic level. Leakage currents up to $\pm 10\mu\text{A}$ from the high impedance state of the processor's logic drivers could cause standard CMOS enable inputs of a transceiver to drift to an incorrect logic level. Additionally, parasitic circuit-board capacitance could cause coupling of V_{CC} or GND to the enable inputs. Without the hot-swap capability, these factors could improperly enable the transceiver's driver or receiver.

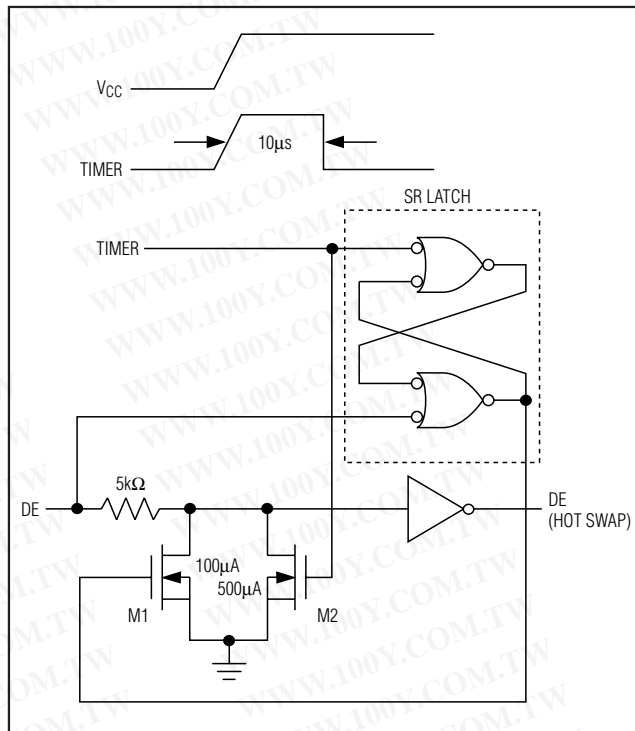

Figure 9. Simplified Structure of the Driver Enable Pin (DE)

When V_{CC} rises, an internal pulldown circuit holds DE low and $\overline{\text{RE}}$ high. After the initial power-up sequence, the pulldown circuit becomes transparent, resetting the hot-swap tolerable input.

Hot-Swap Input Circuitry

The enable inputs feature hot-swap capability. At the input there are two nMOS devices, M1 and M2 (Figure 9). When V_{CC} ramps from zero, an internal $7\mu\text{s}$ timer turns on M2 and sets the SR latch, which also turns on M1. Transistors M2, a 1.5mA current sink, and M1, a $500\mu\text{A}$ current sink, pull DE to GND through a $5\text{k}\Omega$ resistor. M2 is designed to pull DE to the disabled state against an external parasitic capacitance up to 100pF that can drive DE high. After $7\mu\text{s}$, the timer deactivates M2 while M1 remains on, holding DE low against tri-state leakages that can drive DE high. M1 remains on until an external source overcomes the required input current. At this time, the SR latch resets and M1 turns off. When M1 turns off, DE reverts to a standard high-impedance CMOS input. Whenever V_{CC} drops below 1V , the hot-swap input is reset.

For $\overline{\text{RE}}$ there is a complementary circuit employing two pMOS devices pulling $\overline{\text{RE}}$ to V_{CC} .

Half-Duplex RS-485/RS-422 Transceivers in μ DFN

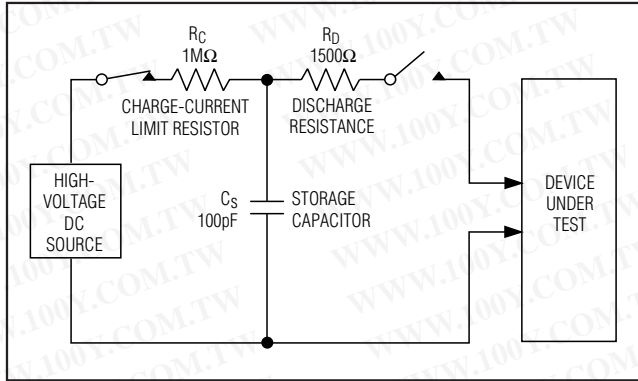

Figure 10a. Human Body ESD Test Model

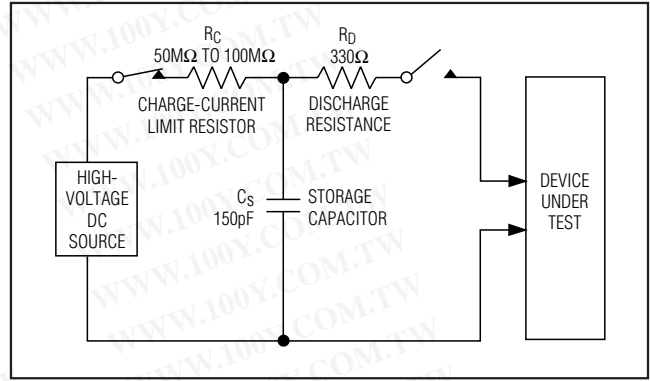

Figure 10c. IEC 61000-4-2 ESD Test Model

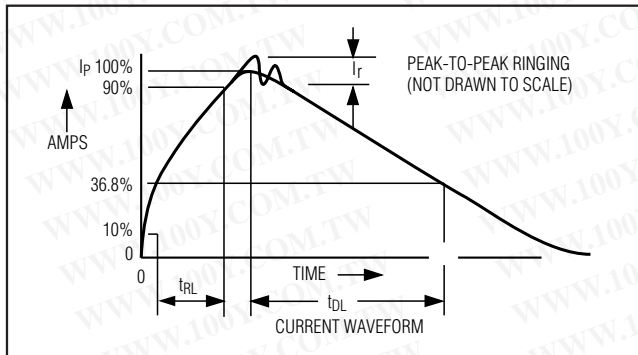

Figure 10b. Human Body Current Waveform

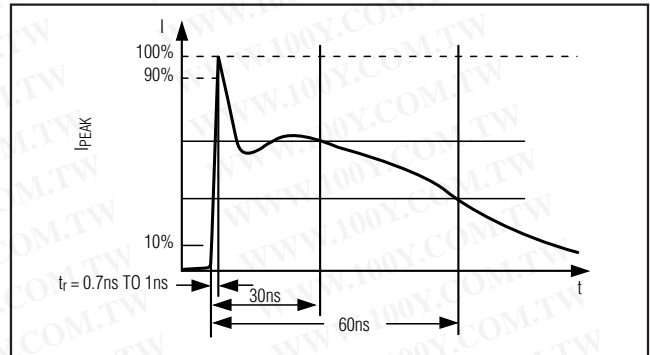

Figure 10d. IEC 61000-4-2 ESD Generator Current Waveform

$\pm 15V$ ESD Protection

As with all Maxim devices, ESD-protection structures are incorporated on all pins to protect against electrostatic discharges encountered during handling and assembly. The driver outputs and receiver inputs of the MAX13485E/MAX13486E have extra protection against static electricity. Maxim's engineers have developed state-of-the-art structures to protect these pins against ESD of $\pm 15kV$ without damage. The ESD structures withstand high ESD in all states: normal operation, shutdown, and powered down. After an ESD event, the MAX13485E/MAX13486E keep working without latchup or damage.

ESD protection can be tested in various ways. The transmitter outputs and receiver inputs of the MAX13485E/MAX13486E are characterized for protection to the following limits:

- $\pm 15kV$ using the Human Body Model
- $\pm 15kV$ using the Air Gap Discharge Method specified in IEC 61000-4-2 (MAX13485E only)

ESD Test Conditions

ESD performance depends on a variety of conditions. Contact Maxim for a reliability report that documents test setup, test methodology, and test results.

Human Body Model

Figure 10a shows the Human Body Model, and Figure 10b shows the current waveform it generates when discharged into a low impedance. This model consists of a 100pF capacitor charged to the ESD voltage of interest, which is then discharged into the test device through a 1.5k Ω resistor.

IEC 61000-4-2

The IEC 61000-4-2 standard covers ESD testing and performance of finished equipment. However, it does not specifically refer to integrated circuits. The MAX13485E/MAX13486E help equipment designs to meet IEC 61000-4-2, without the need for additional ESD-protection components.

The major difference between tests done using the Human Body Model and IEC 61000-4-2 is higher peak current in IEC 61000-4-2 because series resistance is lower in the IEC 61000-4-2 model. Hence, the ESD

Half-Duplex RS-485/RS-422 Transceivers in μ DFN

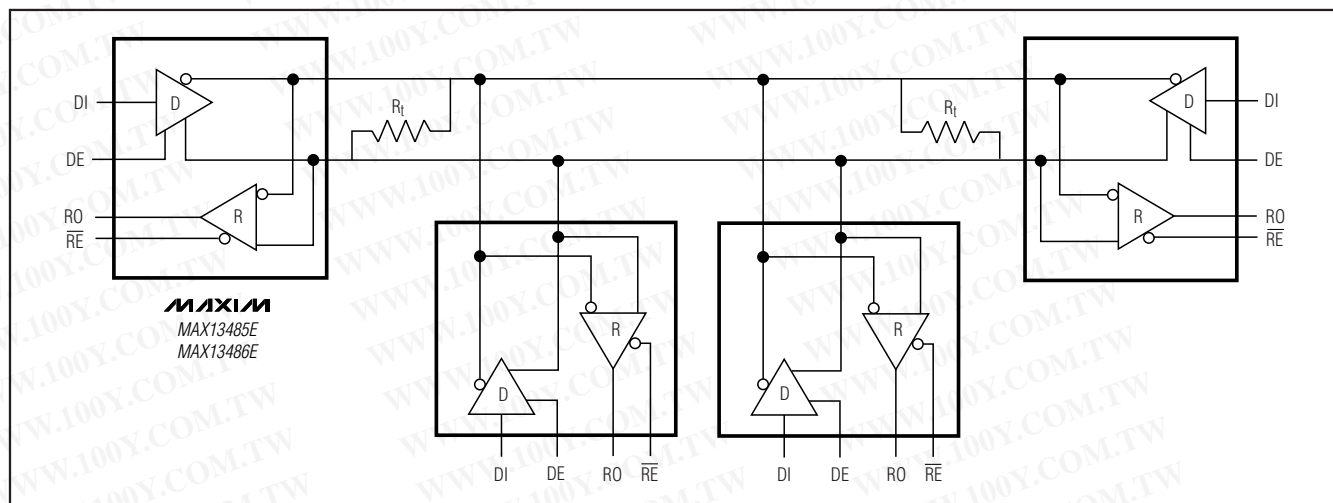

Figure 11. Typical Half-Duplex RS-485 Network

withstand voltage measured to IEC 61000-4-2 is generally lower than that measured using the Human Body Model. Figure 10c shows the IEC 61000-4-2 model, and Figure 10d shows the current waveform for the IEC 61000-4-2 ESD Contact Discharge test.

Machine Model

The machine model for ESD tests all pins using a 200pF storage capacitor and zero discharge resistance.

The objective is to emulate the stress caused when I/O pins are contacted by handling equipment during test and assembly. Of course, all pins require this protection, not just RS-485 inputs and outputs.

The air-gap test involves approaching the device with a charged probe. The contact-discharge method connects the probe to the device before the probe is energized.

Applications Information

128 Transceivers on the Bus

The standard RS-485 receiver input impedance is 12k Ω (1-unit load), and the standard driver can drive up to 32-unit loads. The MAX13485E/MAX13486E have a 1/4-unit load receiver input impedance (48k Ω), allowing up to 128 transceivers to be connected in parallel on one communication line. Any combination of these devices, as well as other RS-485 transceivers with a total of 32-unit loads or fewer, can be connected to the line.

Reduced EMI and Reflections

The MAX13485E features reduced slew-rate drivers that minimize EMI and reduce reflections caused by improperly terminated cables, allowing error-free data transmission up to 500kbps.

Low-Power Shutdown Mode

Low-power shutdown mode is initiated by bringing both \overline{RE} high and DE low. In shutdown, the devices draw a maximum of 10 μ A of supply current.

\overline{RE} and DE can be driven simultaneously. The devices are guaranteed not to enter shutdown if \overline{RE} is high and DE is low for less than 50ns. If the inputs are in this state for at least 700ns, the devices are guaranteed to enter shutdown.

Enable times t_{ZH} and t_{ZL} (see the *Switching Characteristics*) assume the devices were not in a low-power shutdown state. Enable times $t_{ZH}(SHDN)$ and $t_{ZL}(SHDN)$ assume the devices were in shutdown state. It takes drivers and receivers longer to become enabled from low-power shutdown mode ($t_{ZH}(SHDN)$, $t_{ZL}(SHDN)$) than from driver-/receiver-disable mode (t_{ZH} , t_{ZL}).

Line Length

The RS-485/RS-422 standard covers line lengths up to 4000ft.

Typical Applications

The MAX13485E/MAX13486E transceivers are designed for half-duplex, bidirectional data communications on multipoint bus transmission lines. Figure 11 shows typical network applications circuits. To minimize reflections, terminate the line at both ends in its characteristic impedance, and keep stub lengths off the main line as short as possible. The slew-rate-limited MAX13485E is more tolerant of imperfect termination.

Chip Information

PROCESS: BiCMOS

Half-Duplex RS-485/RS-422 Transceivers in μ DFN

Package Information

(The package drawing(s) in this data sheet may not reflect the most current specifications. For the latest package outline information, go to www.maxim-ic.com/packages.)

TOP VIEW

FRONT VIEW

SIDE VIEW

DIM	INCHES		MILLIMETERS	
	MIN	MAX	MIN	MAX
A	0.053	0.069	1.35	1.75
A1	0.004	0.010	0.10	0.25
B	0.014	0.019	0.35	0.49
C	0.007	0.010	0.19	0.25
e	0.050 BSC		1.27 BSC	
E	0.150	0.157	3.80	4.00
H	0.228	0.244	5.80	6.20
L	0.016	0.050	0.40	1.27

VARIATIONS:

DIM	INCHES		MILLIMETERS		N	MS012
	MIN	MAX	MIN	MAX		
D	0.189	0.197	4.80	5.00	8	AA
D	0.337	0.344	8.55	8.75	14	AB
D	0.386	0.394	9.80	10.00	16	AC

NOTES:

1. D&E DO NOT INCLUDE MOLD FLASH.
2. MOLD FLASH OR PROTRUSIONS NOT TO EXCEED 0.15mm (.006").
3. LEADS TO BE COPLANAR WITHIN 0.10mm (.004").
4. CONTROLLING DIMENSION: MILLIMETERS.
5. MEETS JEDEC MS012.
6. N = NUMBER OF PINS.

DALLAS SEMICONDUCTOR		MAXIM	
<small>PROPRIETARY INFORMATION</small>			
TITLE: PACKAGE OUTLINE, .150" SOIC			
<small>APPROVAL</small>	<small>DOCUMENT CONTROL NO.</small> 21-0041	<small>REV.</small> B	<small>1</small> / <small>1</small>

SOICN EFS

MAX13485E/MAX13486E

Half-Duplex RS-485/RS-422 Transceivers in μ DFN

Package Information (continued)

(The package drawing(s) in this data sheet may not reflect the most current specifications. For the latest package outline information, go to www.maxim-ic.com/packages.)

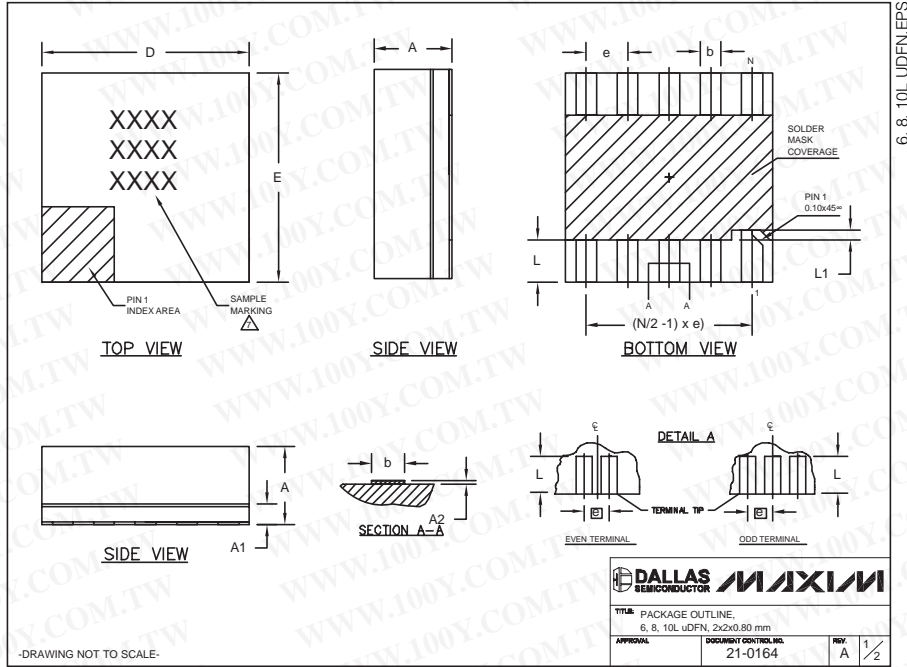

6, 8, 10L uDFN EPFS

COMMON DIMENSIONS			
SYMBOL	MIN.	NOM.	MAX.
A	0.70	0.75	0.80
A1	0.15	0.20	0.25
A2	0.020	0.025	0.035
D	1.95	2.00	2.05
E	1.95	2.00	2.05
L	0.30	0.40	0.50
L1	0.10 REF.		

PACKAGE VARIATIONS				
PKG. CODE	N	e	b	(N/2 - 1) x e
L622-1	6	0.65 BSC	0.30±0.05	1.30 REF.
L822-1	8	0.50 BSC	0.25±0.05	1.50 REF.
L1022-1	10	0.40 BSC	0.20±0.03	1.60 REF.

NOTES:

- ALL DIMENSIONS ARE IN mm. ANGLES IN DEGREES.
- COPLANARITY SHALL NOT EXCEED 0.08mm.
- WARPAGE SHALL NOT EXCEED 0.10mm.
- PACKAGE LENGTH/PACKAGE WIDTH ARE CONSIDERED AS SPECIAL CHARACTERISTIC(S).
- "N" IS THE TOTAL NUMBER OF LEADS.
- NUMBER OF LEADS SHOWN ARE FOR REFERENCE ONLY.
- MARKING IS FOR PACKAGE ORIENTATION REFERENCE ONLY.

-DRAWING NOT TO SCALE-

DALLAS SEMICONDUCTOR MAXIM

TITLE: PACKAGE OUTLINE,
6, 8, 10L uDFN, 2x2x0.80 mm

APPROVAL: DOCUMENT CONTROL NO. 21-0164 REV A 2/2

Maxim cannot assume responsibility for use of any circuitry other than circuitry entirely embodied in a Maxim product. No circuit patent licenses are implied. Maxim reserves the right to change the circuitry and specifications without notice at any time.