



MAX4820/MAX4821

+3.3V/+5V, 8-Channel, Cascadable Relay Drivers with Serial/Parallel Interface

General Description

The MAX4820/MAX4821 8-channel relay drivers offer built-in kickback protection and drive +3.3V/+5V non-latching or dual-coil-latching relays. These devices are especially useful when driving +3V relays. Each independent open-drain output features a 2Ω on-resistance and is guaranteed to sink 70mA (min) of load current. Both devices consume less than 50μA (max) quiescent current and have 1μA output off-leakage current.

The MAX4820 features an SPI™-/QSPI™-/MICROWIRE™-compatible serial interface. Input data is shifted into an 8-bit shift register and latched to the outputs when CS transitions from low to high. Each data bit in the shift register corresponds to a specific output, allowing independent control of all outputs.

The MAX4821 features a 4-bit (A0, A1, A2, LVL) parallel-input interface. The first three bits (A0, A1, A2) determine the output address, and the fourth bit (LVL) determines whether the selected output is switched on or off. Data is latched to the outputs when CS transitions from low to high.

Both devices feature separate set and reset functions that allow the user to turn on or turn off all outputs simultaneously with a single control line. Built-in hysteresis (Schmidt trigger) on all digital inputs allows this device to be used with slow rising and falling signals, such as those from optocouplers or RC power-up initialization circuits. The MAX4820/MAX4821 are available in 20-pin TSSOP and space-saving 20-pin Thin QFN packages.

Applications

Central Office
 ATE
 DSL, ADSL Line Cards
 Industrial Equipment
 E1/T1 Redundancy

Pin Configurations continued at end of data sheet.

Typical Application Circuits and Functional Diagrams appear at end of data sheet.

SPI and QSPI are trademarks of Motorola, Inc.

MICROWIRE is a trademark of National Semiconductor Corp.



Features

- ◆ 8 Independent Output Channels
- ◆ Built-In Inductive Kickback Protection
- ◆ Drive +3V and +5V Relays
- ◆ Guaranteed 70mA (min) Coil Drive Current
- ◆ $\overline{\text{SET}}$ Function to Turn On All Outputs Simultaneously
- ◆ $\overline{\text{RESET}}$ Function to Turn Off All Outputs Simultaneously
- ◆ SPI-/QSPI-/MICROWIRE-Compatible Serial Interface (MAX4820)
- ◆ Serial Digital Output for Daisy Chaining (MAX4820)
- ◆ Parallel Interface (MAX4821)
- ◆ Low 50μA (max) Quiescent Supply Current
- ◆ Space-Saving 20-Pin Thin QFN Package

Ordering Information

PART	TEMP RANGE	PIN-PACKAGE
MAX4820ETP+	-40°C to +85°C	20 Thin QFN-EP*
MAX4820EUP+	-40°C to +85°C	20 TSSOP-EP*
MAX4821ETP+	-40°C to +85°C	20 Thin QFN-EP*
MAX4821EUP+	-40°C to +85°C	20 TSSOP-EP*

+Denotes a lead(Pb)-free/RoHS-compliant package.

*EP = Exposed pad.

Pin Configurations

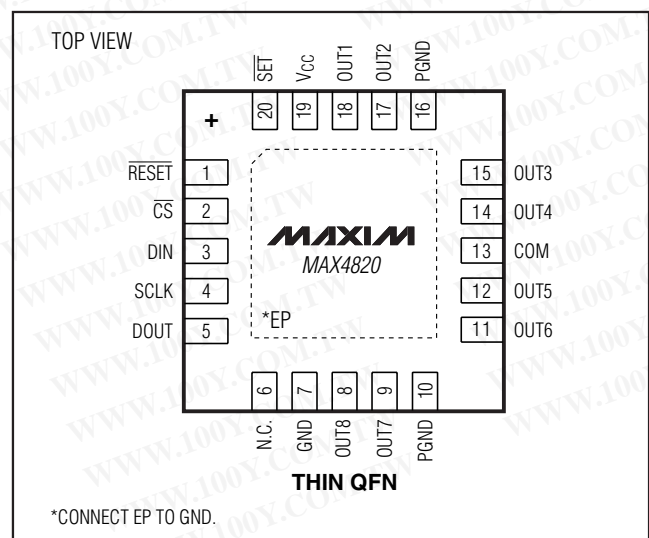

+3.3V/+5V, 8-Channel, Cascadable Relay Drivers with Serial/Parallel Interface

ABSOLUTE MAXIMUM RATINGS

(All voltages referenced to GND.)

V _{CC} , COM.....	-0.3V to +6.0V
OUT ₁	-0.3V to (V _{COM} + 0.3V)
CS, SCLK, DIN, SET, RESET, A0, A1, A2, LVL.....	-0.3V to +6.0V
DOUT.....	-0.3V to (V _{CC} + 0.3V)
Continuous OUT ₁ Current (all outputs turned on)	150mA
Continuous OUT ₁ Current (single output turned on)	300mA

Continuous Power Dissipation (T_A = +70°C)

20-Lead Thin QFN (derate 16.9mW/°C above +70°C) ..	1350mW
θ _{JA} (Note 1)	59.3°C/W
20-Pin TSSOP (derate 21.7mW/°C above +70°C)	1739mW
θ _{JA} (Note 1)	46°C/W
Operating Temperature Range	-40°C to +85°C
Junction Temperature	+150°C
Storage Temperature Range	-65°C to +150°C
Soldering Temperature (10s)	+300°C
Reflow Temperature	+260°C

Note 1: Package thermal resistances were obtained using the method described in JEDEC specifications. For detailed information on package thermal considerations, refer to www.maxim-ic.com/thermal-tutorial.

Stresses beyond those listed under "Absolute Maximum Ratings" may cause permanent damage to the device. These are stress ratings only, and functional operation of the device at these or any other conditions beyond those indicated in the operational sections of the specifications is not implied. Exposure to absolute maximum rating conditions for extended periods may affect device reliability.

ELECTRICAL CHARACTERISTICS

(V_{CC} = +3V to +5.5V, V_{COM} = V_{CC}, T_A = -40°C to +85°C, unless otherwise noted. Typical values are at T_A = +25°C.) (Note 2)

PARAMETER	SYMBOL	CONDITIONS	MIN	TYP	MAX	UNITS
Operating Voltage	V _{CC}		2.3		5.5	V
Quiescent Current	I _Q	I _{OUT1} = 0μA, logic inputs = 0V or V _{CC}		15	50	μA
		V _{CC} = 3.6V				
		V _{CC} = 5.5V		20	70	
Thermal Shutdown				160		°C
Power-On Reset			0.8	1.5	2.2	V
Power-On Reset Hysteresis				140		mV
DIGITAL INPUTS (SCLK, DIN, CS, LVL, A0, A1, A2, RESET, SET)						
Input Logic-High Voltage	V _{IH}	V _{CC} = 3.3V	2.0			V
		V _{CC} = 5V	2.4			
Input Logic-Low Voltage	V _{IL}	V _{CC} = 3.3V			0.6	V
		V _{CC} = 5V			0.8	
Input Logic Hysteresis	V _{HYST}			150		mV
Input Leakage Currents	I _{LEAK}	Input voltages = 0V or 5.5V	-1.0	0.01	+1.0	μA
C _{IN} Input Capacitance	C _{IN}			5		pF
DIGITAL OUTPUT (DOUT)						
DOUT Low Voltage	V _{OL}	I _{SINK} = 6mA			0.4	V
DOUT High Voltage	V _{OH}	I _{SOURCE} = 0.5mA	V _{CC} - 0.5			V
RELAY OUTPUT DRIVERS (OUT1–OUT8)						
OUT ₁ Drive Current		V _{CC} = 2.7V	70			mA
		V _{CC} = 4.5V	70			
OUT ₁ On-Resistance	R _{ON}	V _{CC} = 2.7V		2	6	Ω
OUT ₁ Voltage	V _{OUT1}	V _{CC} = 3.0V, I _{OUT1} = 70mA			0.4	V
I _{OUT1} Off-Leakage Current	I _{LEAK}	V _{OUT1} = V _{CC} , all outputs off	-1		+1	μA
Kickback Diode Forward Voltage	V _{FORW}	I _{OUT1} = 150mA (Note 3)			1.5	V

3.3V/+5V, 8-Channel, Cascadable Relay Drivers with Serial/Parallel Interface

MAX4820/MAX4821

ELECTRICAL CHARACTERISTICS (continued)

($V_{CC} = +3V$ to $+5.5V$, $V_{COM} = V_{CC}$, $T_A = -40^{\circ}C$ to $+85^{\circ}C$, unless otherwise noted. Typical values are at $T_A = +25^{\circ}C$.) (Note 2)

PARAMETER	SYMBOL	CONDITIONS	MIN	TYP	MAX	UNITS
SPI TIMING (MAX4820)						
Turn-On Time (OUT ₋)	t _{ON}	From rising edge of \overline{CS} , $R_L = 50\Omega$, $C_L = 50pF$			1.0	μs
Turn-Off Time (OUT ₋)	t _{OFF}	From rising edge of \overline{CS} , $R_L = 50\Omega$, $C_L = 50pF$			1.0	μs
SCLK Frequency	f _{SCLK}		0		2.1	MHz
Cycle Time	t _{CH} + t _{CL}		480			ns
\overline{CS} Fall to SCLK Rise Setup	t _{CSS}		240			ns
\overline{CS} Rise to SCLK Hold	t _{CSH}		240			ns
SCLK High Time	t _{CH}		190			ns
SCLK Low Time	t _{CL}		190			ns
Data Setup Time	t _{DS}		100			ns
Data Hold Time	t _{DH}		0			ns
SCLK Fall to DOUT Valid	t _{DO}	50% of SCLK to 10% of DOUT, $C_L = 50pF$		85	120	ns
Rise Time (DIN, SCLK, \overline{CS} , \overline{SET} , RESET)	t _{SCR}	20% of V_{CC} to 70% of V_{CC} , $C_L = 50pF$			2	μs
Fall Time (DIN, SCLK, \overline{CS} , RESET, SET)	t _{SCF}	20% of V_{CC} to 70% of V_{CC} , $C_L = 50pF$			2	μs
RESET Min Pulse Width	t _{RW}		70			ns
SET Min Pulse Width	t _{SW}		70			ns
PARALLEL TIMING (MAX4821)						
Turn-On Time	t _{ON}	From rising edge of \overline{CS} , $R_L = 50\Omega$, $C_L = 50pF$			1	μs
Turn-Off Time	t _{OFF}	From rising edge of \overline{CS} , $R_L = 50\Omega$, $C_L = 50pF$			1	μs
LVL Setup Time	t _{LS}		100			ns
LVL Hold Time	t _{LH}		0			ns
Address to \overline{CS} Setup Time	t _{AH}		100			ns
Address to \overline{CS} Hold Time	t _{AS}		0			ns
Rise Time (A2, A1, A0, LVL)	t _{SCR}	20% of V_{CC} to 70% of V_{CC} , $C_L = 50pF$			2	μs
Fall Time (A2, A1, A0, LVL)	t _{SCF}	20% of V_{CC} to 70% of V_{CC} , $C_L = 50pF$			2	μs
RESET Pulse Width	t _{RW}		70			ns
SET Pulse Width	t _{SW}		70			ns

Note 2: Specifications at $-40^{\circ}C$ are guaranteed by design and not production tested.

Note 3: After relay turn-off, inductive kickback may momentarily cause the voltage at OUT₋ to exceed V_{COM} . This is considered part of normal operation and will not damage the device.

+3.3V/+5V, 8-Channel, Cascadable Relay Drivers with Serial/Parallel Interface

Typical Operating Characteristics

($V_{COM} = V_{CC}$, $T_A = -40^{\circ}\text{C}$ to $+85^{\circ}\text{C}$, unless otherwise noted. Typical values are at $T_A = +25^{\circ}\text{C}$.)

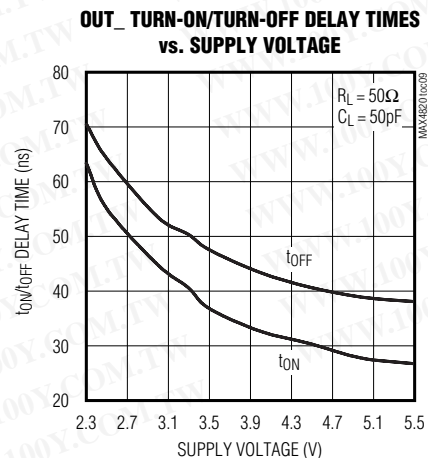
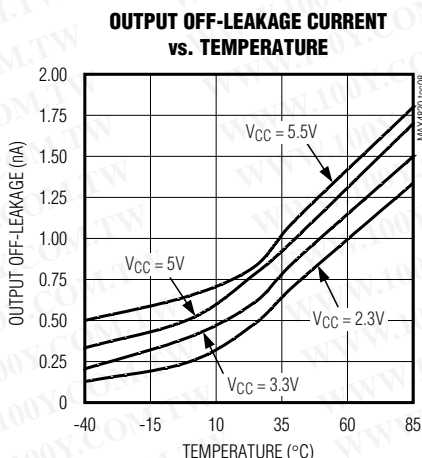
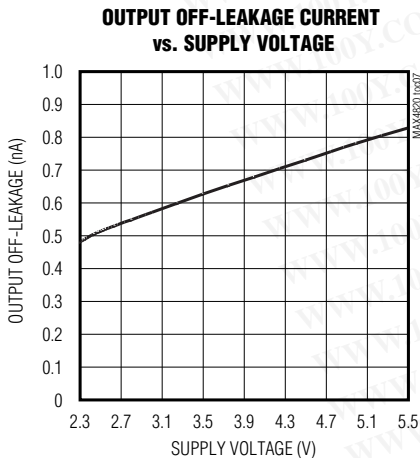
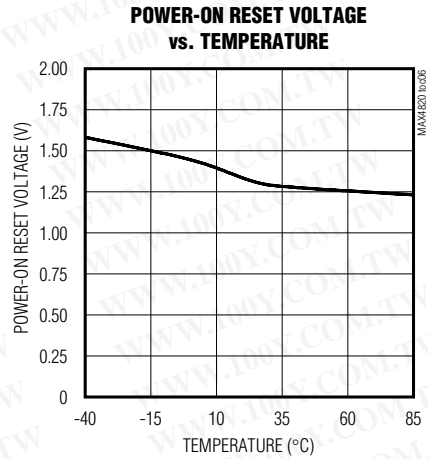
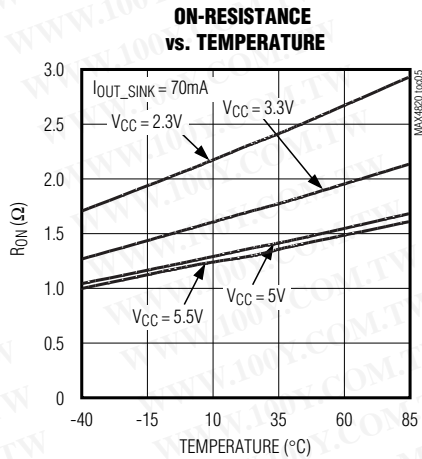
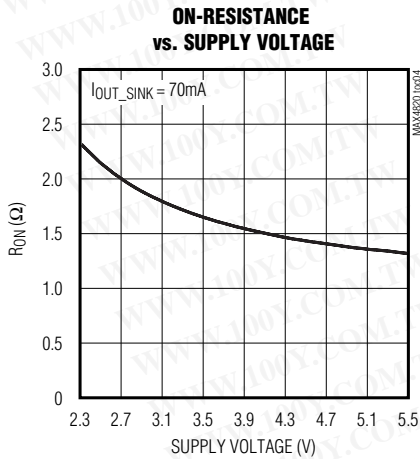
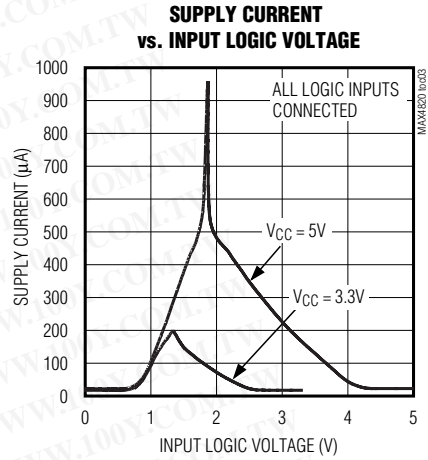
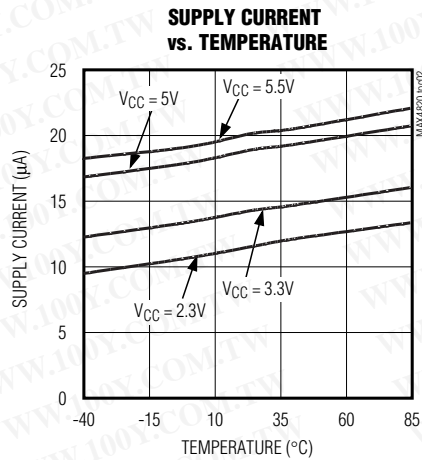
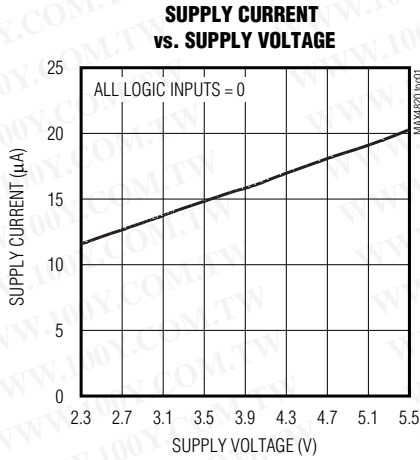

3.3V/+5V, 8-Channel, Cascadable Relay Drivers with Serial/Parallel Interface

Typical Operating Characteristics (continued)

($V_{COM} = V_{CC}$, $T_A = -40^{\circ}\text{C}$ to $+85^{\circ}\text{C}$, unless otherwise noted. Typical values are at $T_A = +25^{\circ}\text{C}$.)

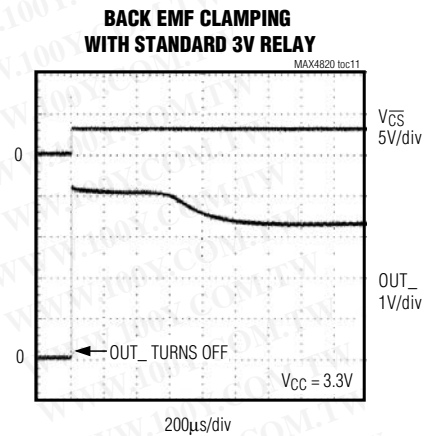
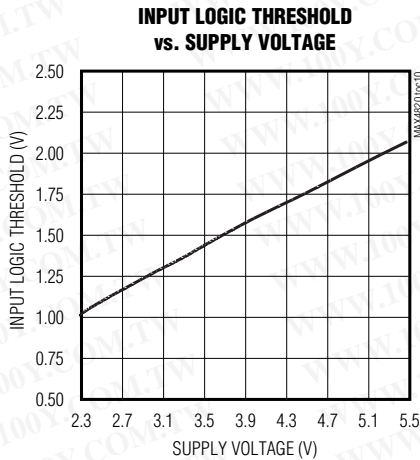

Pin Description

PIN				NAME	FUNCTION
MAX4820		MAX4821			
THIN QFN	TSSOP	THIN QFN	TSSOP		
1	3	1	3	$\overline{\text{RESET}}$	Reset Input. Drive $\overline{\text{RESET}}$ low to clear all latches and registers (all outputs are turned off). $\overline{\text{RESET}}$ overrides all other inputs. If $\overline{\text{RESET}}$ and $\overline{\text{SET}}$ are pulled low at the same time, then $\overline{\text{RESET}}$ takes precedence.
2	4	2	4	$\overline{\text{CS}}$	Chip-Select Input. MAX4820: Drive $\overline{\text{CS}}$ low to select the device. When $\overline{\text{CS}}$ is low, data at DIN is clocked into the 8-bit shift register on SCLK's rising edge. Drive $\overline{\text{CS}}$ from low to high to latch the data to the registers and activate the appropriate relays. MAX4821: Drive $\overline{\text{CS}}$ low to select the device and set level on LVL. Drive $\overline{\text{CS}}$ from low to high to latch the address and level data to the output.
3	5	—	—	DIN	Serial-Data Input
4	6	—	—	SCLK	Serial-Clock Input
5	7	—	—	DOUT	Serial-Data Output. DOUT is the output of the 8-bit shift register. This output can be used to daisy chain multiple MAX4820s. The data at DOUT appears synchronous to SCLK's falling edge.
6	8	—	—	N.C.	No Connection
7	9	7	9	GND	Ground
8	10	8	10	OUT8	Open-Drain Output 8. Connect OUT8 to the low side of a relay coil. This output is pulled to PGND when activated, but otherwise is high impedance.
9	11	9	11	OUT7	Open-Drain Output 7. Connect OUT7 to the low side of a relay coil. This output is pulled to PGND when activated, but otherwise is high impedance.
10, 16	12, 18	10, 16	12, 18	PGND	Power Ground. PGND is a return for the output sinks. Connect PGND pins together and to GND.
11	13	11	13	OUT6	Open-Drain Output 6. Connect OUT6 to the low side of a relay coil. This output is pulled to PGND when activated, but otherwise is high impedance.

MAX4820/MAX4821

+3.3V/+5V, 8-Channel, Cascadable Relay Drivers with Serial/Parallel Interface

Pin Description (continued)

PIN				NAME	FUNCTION
MAX4820		MAX4821			
THIN QFN	TSSOP	THIN QFN	TSSOP		
12	14	12	14	OUT5	Open-Drain Output 5. Connect OUT5 to the low side of a relay coil. This output is pulled to PGND when activated, but otherwise is high impedance.
13	15	13	15	COM	Common Free-Wheeling Diodes. Connect COM to V _{CC} . COM can also be connected to a separate supply that is higher than V _{CC} . In that case, bypass V _{CC} to GND with a 0.1μF capacitor.
14	16	14	16	OUT4	Open-Drain Output 4. Connect OUT4 to the low side of a relay coil. This output is pulled to PGND when activated, but otherwise is high impedance.
15	17	15	17	OUT3	Open-Drain Output 3. Connect OUT3 to the low side of a relay coil. This output is pulled to PGND when activated, but otherwise is high impedance.
17	19	17	19	OUT2	Open-Drain Output 2. Connect OUT2 to the low side of a relay coil. This output is pulled to PGND when activated, but otherwise is high impedance.
18	20	18	20	OUT1	Open-Drain Output 1. Connect OUT1 to the low side of a relay coil. This output is pulled to PGND when activated, but otherwise is high impedance.
19	1	19	1	V _{CC}	Input Supply Voltage. Bypass V _{CC} to GND with a 0.1μF capacitor.
20	2	20	2	$\overline{\text{SET}}$	Set Input. Drive $\overline{\text{SET}}$ low to set all latches and registers high (all outputs are turned on). $\overline{\text{SET}}$ overrides all parallel and serial control inputs. RESET overrides $\overline{\text{SET}}$ under all conditions.
—	—	3	5	LVL	Level Input. LVL determines whether the selected address is switched on or off. A logic high on LVL switches on the addressed output. A logic low on LVL switches off the addressed output.
—	—	4	6	A0	Digital Address “0” Input. (See Table 2 for address mapping.)
—	—	5	7	A1	Digital Address “1” Input. (See Table 2 for address mapping.)
—	—	6	8	A2	Digital Address “2” Input. (See Table 2 for address mapping.)
—	—	—	—	EP	Exposed Pad. Connect exposed pad to GND.

Detailed Description

The MAX4820/MAX4821 8-channel relay drivers offer built-in kickback protection and drive +3.3V/+5V non-latching or dual-coil-latching relays. These devices are especially useful when driving +3V relays. Each independent open-drain output features a 2Ω on-resistance and is guaranteed to sink 70mA (min) load current. Both devices consume less than 50μA (max) quiescent current and feature 1μA (min) output off-leakage current.

The MAX4820 features an SPI/QSPI/MICROWIRE-compatible serial interface. Input data is shifted into an 8-bit shift register and latched to the outputs when $\overline{\text{CS}}$ transitions from low to high. Each data bit in the shift register corresponds to a specific output, allowing independent control of all outputs.

The MAX4821 features a 4-bit (A0, A1, A2, LVL) parallel input interface. The three bits (A0, A1, A2) determine the output address, and LVL determines whether the selected output is switched on or off. Data is latched to the outputs when $\overline{\text{CS}}$ transitions from low to high.

Both devices feature separate set and reset functions that allow the user to turn on or turn off all outputs simultaneously with a single control line. Built-in hysteresis (Schmidt trigger) on all digital inputs allows this device to be used with slow rising and falling signals, such as those from optocouplers or RC power-up initialization circuits. The MAX4820/MAX4821 are available in 20-pin TSSOP and space-saving 20-pin Thin QFN packages.

3.3V/+5V, 8-Channel, Cascadable Relay Drivers with Serial/Parallel Interface

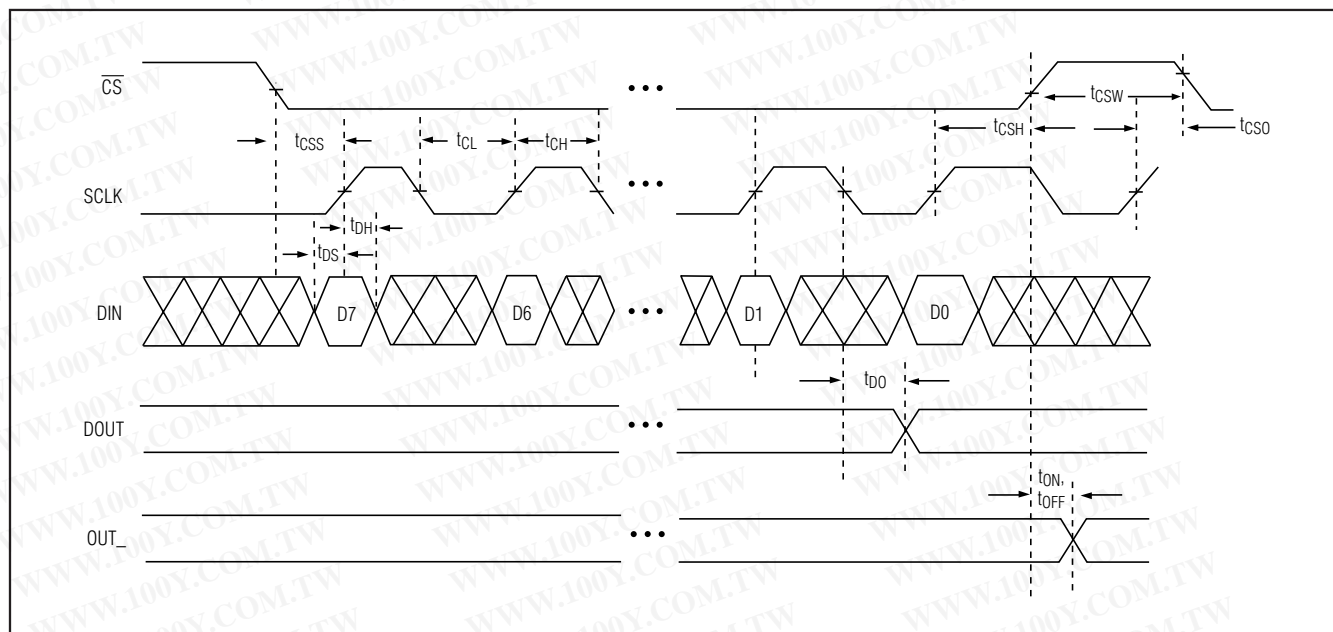

Figure 1. 3-Wire Serial-Interface Timing Diagram (MAX4820 only)

Table 1. Serial Input Address Map (MAX4820 Only)

DIN	D0	D1	D2	D3	D4	D5	D6	D7
OUT_	OUT1	OUT2	OUT3	OUT4	OUT5	OUT6	OUT7	OUT8

Digital Interface

Serial Interface (MAX4820)

The serial interface consists of an 8-bit shift register and parallel latch controlled by SCLK and \overline{CS} . The input to the shift register is an 8-bit word. Each data bit controls one of the eight outputs, with the most significant bit (D7) corresponding to OUT8 and the least significant bit (D0) corresponding to OUT1 (see Table 1). When \overline{CS} is low (device is selected), data at DIN is clocked into the shift register synchronously with SCLK's rising edge. Driving \overline{CS} from low to high latches the data in the shift register to the parallel latch.

DOUT is the output of the shift register. Data appears on DOUT synchronously with SCLK's falling edge and is identical to the data at DIN delayed by eight clock cycles. When shifting the input data, D7 is the first bit in and out of the shift register.

While \overline{CS} is low, the switches always remain in their previous state. Drive \overline{CS} high after 8 bits of data have been shifted in to update the output state and inhibit further data from entering the shift register. When \overline{CS} is high, transitions at DIN and SCLK have no effect on the out-

put, and the first input bit (D7) is present at DOUT.

If the number of data bits entered while \overline{CS} is low is greater or less than 8, the shift register contains only the last 8 data bits, regardless of when they were entered.

The 3-wire serial interface is compatible with SPI, QSPI, and MICROWIRE standards. The latch that drives the analog switch is updated on the rising edge of \overline{CS} , regardless of SCLK's state.

Parallel Interface (MAX4821)

The parallel interface consists of three address bits (A0, A1, A2) and one level selector bit (LVL). The address bits determine which output is updated, and the level bit determines whether the addressed output is switched on (LVL = high) or off (LVL = low). When \overline{CS} is high, the address and level bits have no effect on the state of the outputs. Driving \overline{CS} from low to high latches the address and level data to the parallel register and updates the state of the outputs. Address data entered after \overline{CS} is pulled low is not reflected in the state of the outputs following the next low-to-high transition on \overline{CS} (Figure 2).

+3.3V/+5V, 8-Channel, Cascadable Relay Drivers with Serial/Parallel Interface

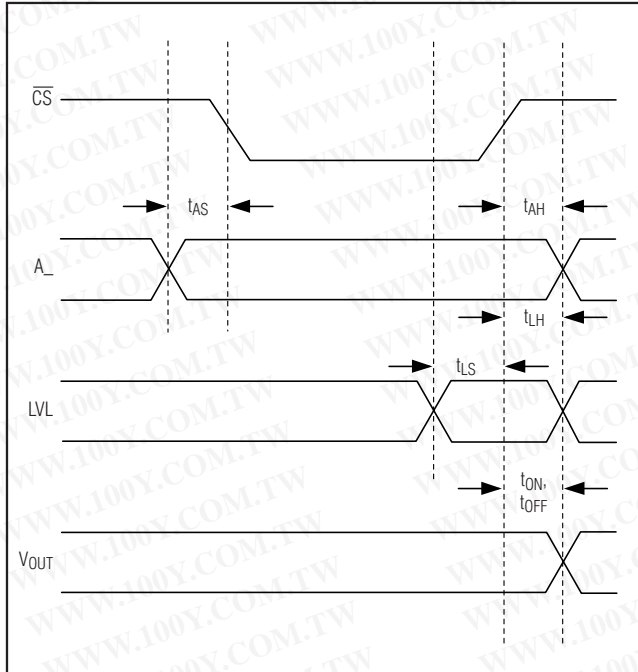

Figure 2. Parallel Interface Timing Diagram (MAX4821 only)

Table 2. Parallel Interface Address Map (MAX4821 Only)

A2	A1	A0	OUTPUT
Low	Low	Low	OUT1
Low	Low	High	OUT2
Low	High	Low	OUT3
Low	High	High	OUT4
High	Low	Low	OUT5
High	Low	High	OUT6
High	High	Low	OUT7
High	High	High	OUT8

SET/RESET Functions

The MAX4820/MAX4821 feature set and reset inputs that allow the user to simultaneously turn all outputs on or off using a single control line. Drive \overline{SET} low to set all latches and registers to 1 and turn all outputs on. \overline{SET} overrides all serial/parallel control inputs. Drive \overline{RESET} low to clear all latches and registers and turn all outputs off. \overline{RESET} overrides all other inputs, including \overline{SET} .

Applications Information

Daisy Chaining

The MAX4820 features a digital output, DOUT, that provides a simple way to daisy chain multiple devices. This feature allows the user to drive large banks of relays using only a single serial interface. To daisy chain multiple devices, connect all \overline{CS} pins together, and connect the DOUT of one device to the DIN of another device (see Figure 3). During operation, a stream of serial data

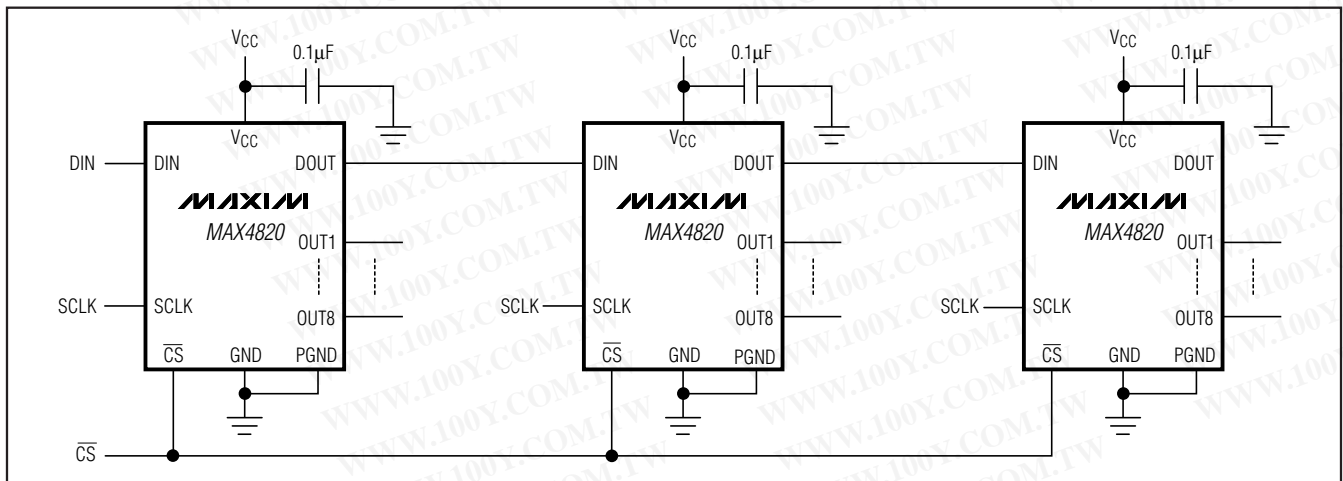

Figure 3. Daisy-Chain Configuration

3.3V/+5V, 8-Channel, Cascadable Relay Drivers with Serial/Parallel Interface

is shifted through all the MAX4820s in series. When \overline{CS} goes high, all outputs update simultaneously.

The MAX4820 can also be used in a slave configuration that allows the user to address individual devices. Connect all the DIN pins together, and use the \overline{CS} input to address one device at a time. Drive \overline{CS} low to select a slave and input the data into the shift register. Drive \overline{CS} high to latch the data and turn on the appropriate outputs. Typically, in this configuration only one slave is addressed at a time.

Inductive Kickback Protection

The MAX4820/MAX4821 feature built-in inductive kickback protection to reduce the voltage spike on OUT_n generated by a relay's coil inductance when the output is suddenly switched off. Internal diodes connected from each output to COM allow the inductor current to flow back to the supply. Connect the common cathode (COM) of the internal protection diodes to V_{CC} .

COM also can be connected to a higher voltage than V_{CC} (+6V max) for faster kickback recovery. In this configuration, bypass COM to PGND with a 0.1 μF capacitor.

Relay Manufacturers

COMPANY	PHONE	WEBSITE
Aromat Corp.	310-524-9862	www.aromat.com
CP Clare Corp.	978-524-6700	www.crouzet.com
Coto Techonology	401-943-2686	www.cotorelay.com
Deustch Relays, Inc.	516-499-6000	www.deutschrelays.com
Fujitsu Takamisawa	408-745-4900	www.fujitsufta.com
Hella KG Hueck	734-414-0970	www.hella.com

COMPANY	PHONE	WEBSITE
NEC Electronics, Inc.	800-366-9782	www.nec-global.com
Omron Electronics, Inc.	847-843-7900	www.oeiweb.omron.com
Rockwell/Allen-Bradley	414-382-2000	www.ab.com
Siemens Electromechanical Component, Inc.	770-371-3000	www.sec.siemens.com
Teledyne Relays	213-777-0077	www.teledynereleys.com

Typical Application Circuits

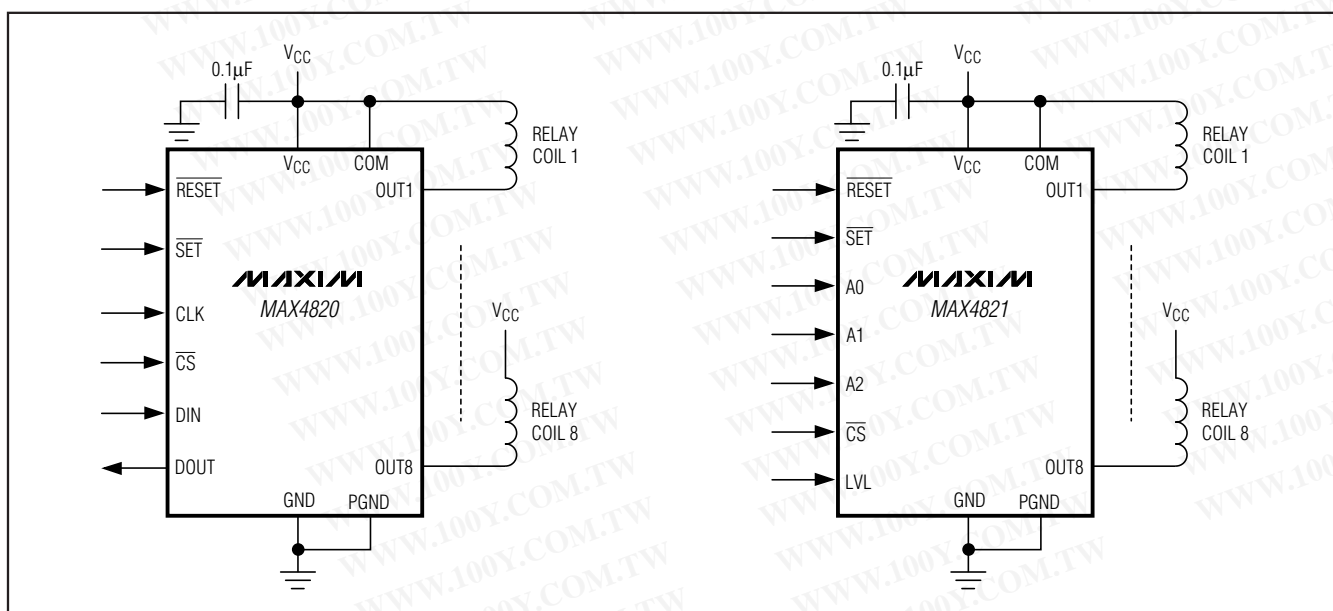

+3.3V/+5V, 8-Channel, Cascadable Relay Drivers with Serial/Parallel Interface

Functional Diagrams

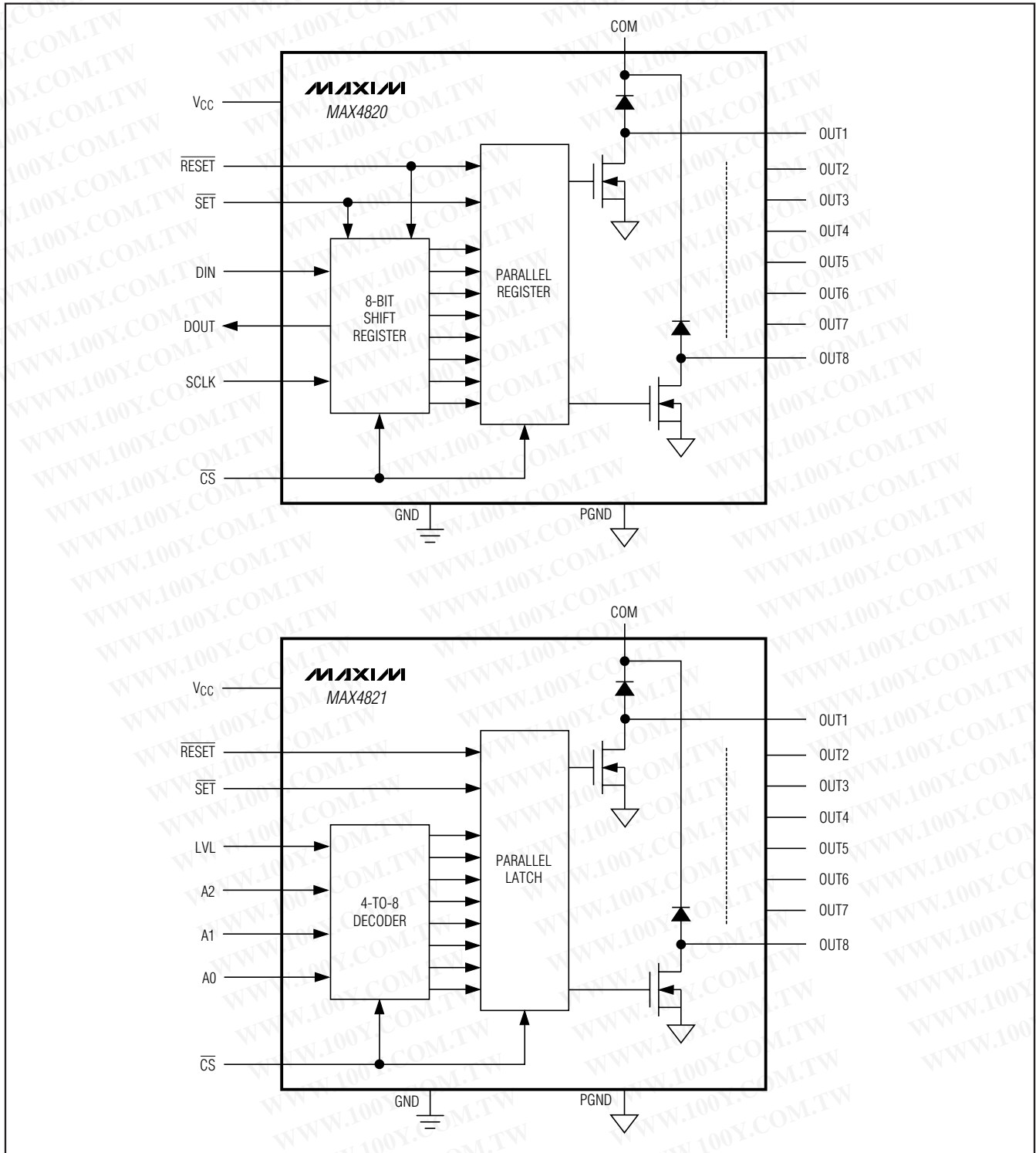

3.3V/+5V, 8-Channel, Cascadable Relay Drivers with Serial/Parallel Interface

Pin Configurations (continued)

MAX4820/MAX4821

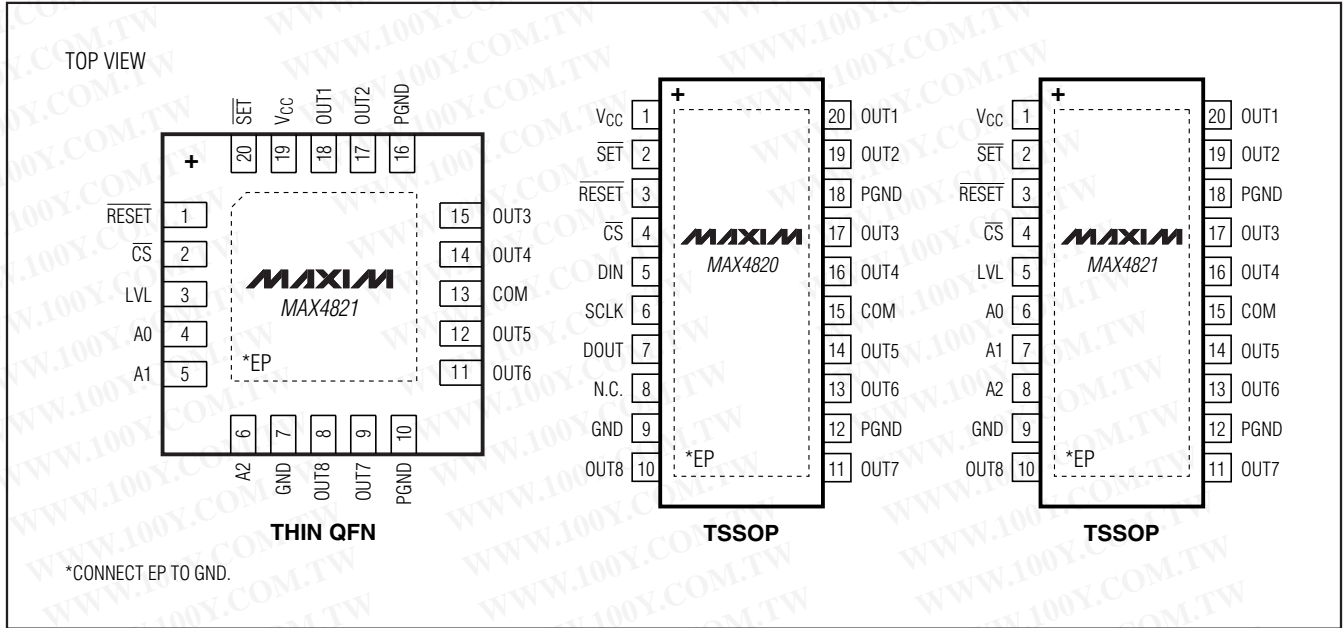

Chip Information

PROCESS: BICMOS

Package Information

For the latest package outline information and land patterns, go to www.maxim-ic.com/packages. Note that a "+", "#", or "-" in the package code indicates RoHS status only. Package drawings may show a different suffix character, but the drawing pertains to the package regardless of RoHS status.

PACKAGE TYPE	PACKAGE CODE	DOCUMENT NO.
20 TQFN-EP	T2044+3	21-0139
20 TSSOP-EP	U20E+1	21-0108

+3.3V/+5V, 8-Channel, Cascadable Relay Drivers with Serial/Parallel Interface

Revision History

REVISION NUMBER	REVISION DATE	DESCRIPTION	PAGES CHANGED
0	1/03	Initial release.	—
1	4/09	Corrected error in the <i>Electrical Characteristics</i> table.	1, 2, 3, 5, 11, 12, 13
2	1/10	Added exposed pad to TSSOP package in the <i>Ordering Information, Pin Description, and Pin Configurations</i> .	1, 6, 11
		Added Reflow Temperature to the <i>Absolute Maximum Ratings</i> section.	2

Maxim cannot assume responsibility for use of any circuitry other than circuitry entirely embodied in a Maxim product. No circuit patent licenses are implied. Maxim reserves the right to change the circuitry and specifications without notice at any time.

12 **Maxim Integrated Products, 120 San Gabriel Drive, Sunnyvale, CA 94086 408-737-7600**