

SC6928B (文件编号: S&CIC0460)

LED Driver IC

DESCRIPTION

SC6928B is an LED Controller driven on a 1/7 to 1/8 duty factor. Eleven segment output lines, six grid output lines, 1 segment/grid output lines, one display memory, control circuit, key scan circuit are all incorporated into a single chip to build a highly reliable peripheral device for a single chip microcomputer. Serial data is fed to SC6928B via a four-line serial interface. Housed in a 28-pin SO Package, SC6928B pin assignments and application circuit are optimized for easy PCB Layout and cost saving advantages.

FEATURES

- CMOS Technology
- Low Power Consumption
- Multiple Display Modes
- Key Scanning
- 8-Step Dimming Circuitry
- Serial Interface for Clock, Data Input, Data Output, Strobe Pins
- Available in 28-Pin, SOP Package

APPLICATION

- Micro-computer Peripheral Device
- VCR set
- Combi set

BLOCK DIAGRAM

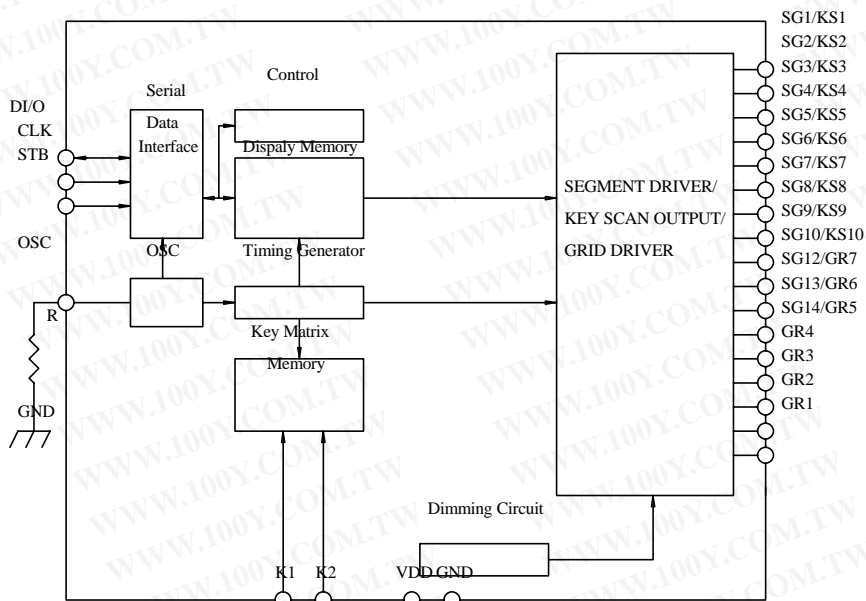

勝特力材料 886-3-5753170
 勝特力电子(上海) 86-21-54151736
 勝特力电子(深圳) 86-755-83298787
[Http://www.100y.com.tw](http://www.100y.com.tw)

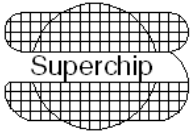

SC6928B(文件编号: S&CIC0460)

LED Driver IC

INPUT/OUTPUT CONFIGURATIONS

The schematic diagrams of the input and output circuits of the logic section are shown below.

Input Pins: CLK, STB & DIN

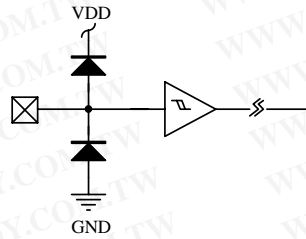

Input Pins: K1 to K2

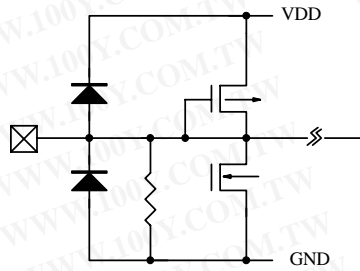

Output Pins: DOUT, GR1 to GR4

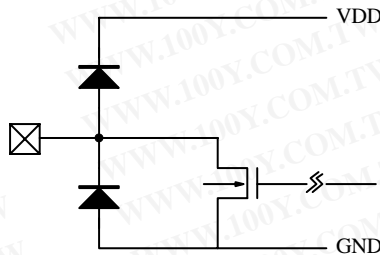

Output Pins: SG1 to SG10

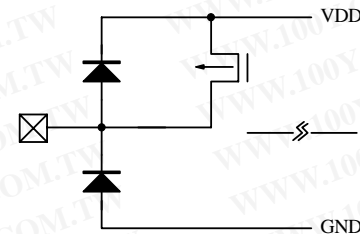

Output Pins: GR5, GR6 and SG12/GR7

勝特力材料 886-3-5753170
勝特力电子(上海) 86-21-54151736
勝特力电子(深圳) 86-755-83298787
[Http://www.100y.com.tw](http://www.100y.com.tw)

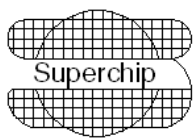

SC6928B (文件编号: S&CIC0460)

LED Driver IC

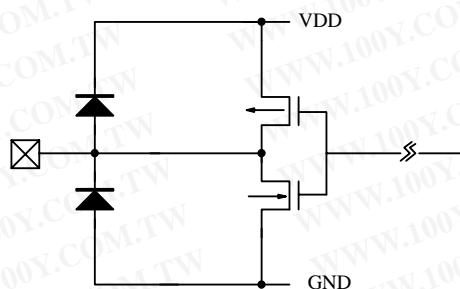

PIN CONFIGURATION

勝特力材料 886-3-5753170
 勝特力电子(上海) 86-21-54151736
 勝特力电子(深圳) 86-755-83298787
[Http://www.100y.com.tw](http://www.100y.com.tw)

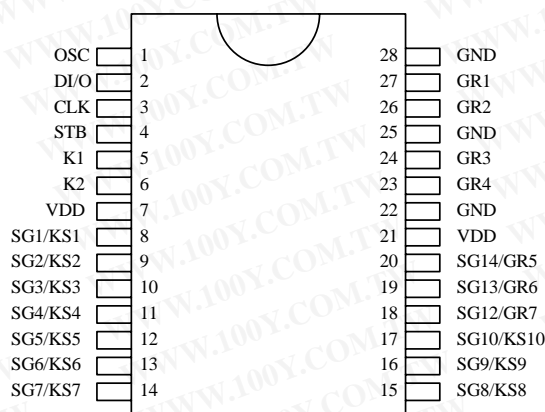

PIN DESCRIPTION

Pin Name	I/O	Description	Pin No.
OSC	I	Oscillator Input Pin A resistor is connected to this pin to determine the oscillation frequency	1
DI/O	I/O	Data Output Pin (N-Channel, Open-Drain) or Data Input pin This pin Outputs/Input serial data at the falling(rising) edge of the shift clock.	2
CLK	I	Clock Input Pin This pin reads serial data at the rising edge and outputs data at the falling edge.	3
STB	I	Serial Interface Strobe Pin The data input after the STB has fallen is processed as a command When this pin is "HIGH", CLK is ignored.	4
K1 to K2	I	Key Data Input Pins. The data sent to these pins are latched at the end of the display cycle. (Internal Pull-Low Resistor)	5,6
GND	-	Ground Pin	22,25,28
SG1/KS1 to SG10/KS10	O	Segment Output Pins (p-channel, open drain) Also acts as the Key Source	8~17
SG12/GR7 to SG14/GR5	O	Segment/Grid Output Pins	18~20

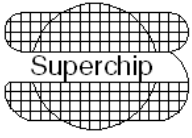

SC6928B (文件编号: S&CIC0460)

LED Driver IC

VDD	-	Power Supply	7,21
GR4 to GR1	O	Grid Output Pins	23,24,26,27

FUNCTIONAL DESCRIPTION

COMMANDS

A command is the first byte (b0 to b7) inputted to SC6928B via the DIN Pin after STB pin has changed from HIGH to LOW Stage. If for some reason the STB Pin is set to HIGH while data or commands are being transmitted, the serial communications is initialized, and the data/commands being transmitted are considered invalid.

Command 1: Display Mode Setting Commands

SC6928B provides 2 display mode settings as shown in the diagram below: As stated earlier a command is the first one byte (b0 to b7) transmitted to SC6928B via the DIN Pin when STB is LOW. However, for these commands, the bit 3 to bit 6 (b2 to b5) are ignored, bit 7 & bit 8 (b6 to b7) are given value of 0.

The Display Mode Setting Commands determine the number of segments and grids to be used (12 to 11 segments, 6 to 7 grids). A display command ON must be executed in order to resume display. If the same mode setting is selected, no command execution is take place, therefore, nothing happens.

When Power is turned ON, the 7-grid, 11-segment modes is selected.

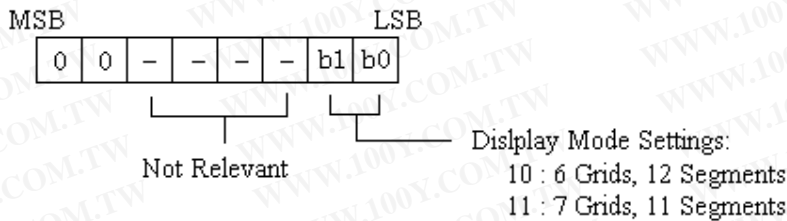

Command 2: Data Setting Commands

The Data Setting Commands executes the Data Write or Data Read Modes for SC6928B. The data Setting Command, the bits 5 and 6 (b4,b5) are ignored, bit 7 (b6) is given the value of 1 while bit 8 (b7) is given the value of 0. Please refer to the diagram below.

When power is turned ON, bit 4 to bit 1 (b3 to b0) are given the value of 0.

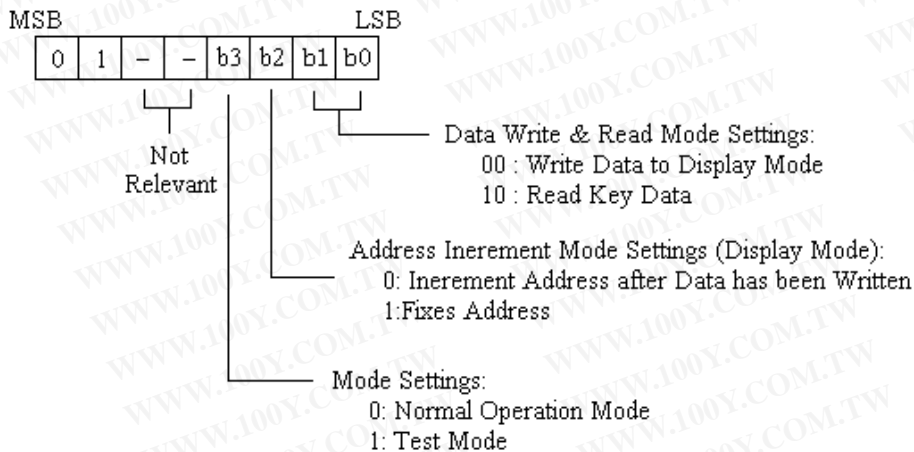

SC6928B KEYMATRIX & KEYINPUT DATA STORAGE RAM

SC6928B Key Matrix consists of 10 x 3 array as shown below:

勝特力材料 886-3-5753170
 勝特力电子(上海) 86-21-54151736
 勝特力电子(深圳) 86-755-83298787
[Http://www.100y.com.tw](http://www.100y.com.tw)

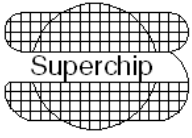

SC6928B(文件编号: S&CIC0460)

LED Driver IC

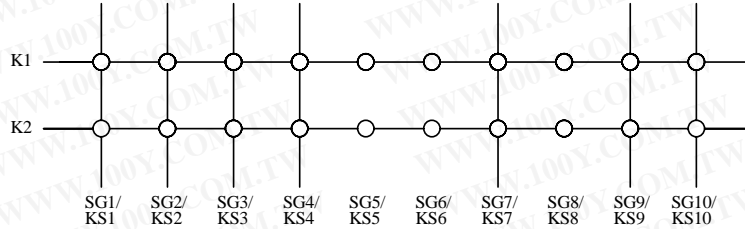

Each data entered by each key is stored as follows and read by a READ Command, starting from the last significant bit. When the most significant bit of the data (b0) has been read, the least significant bit of the next data (b7) is read.

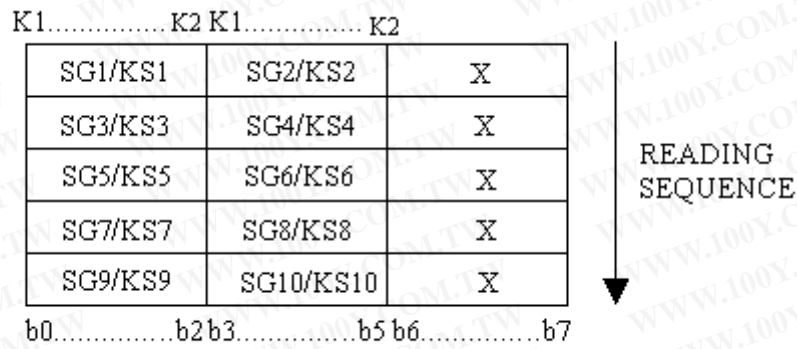

Note: b6 and b7 do not care

Command 3: Address Setting Commands

Address Setting Commands are used to set the address of the display memory. The address is considered valid if it has a value of 00H to 0DH. If the address is set to 0EH or higher, the data is ignored until a valid address is set. When power is turned ON, the address is set at 00H.

Please refer to the diagram below.

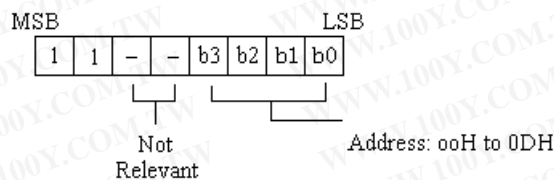

DISPALYMODE AND RAMADDRESS

Data transmitted from an external device to SC6928B via the serial interface are stored in the Display RAM and are assigned addresses. The RAM addresses of SC6928B are given below in 8 bits unit.

勝特力材料 886-3-5753170
 勝特力电子(上海) 86-21-54151736
 勝特力电子(深圳) 86-755-83298787
[Http://www.100y.com.tw](http://www.100y.com.tw)

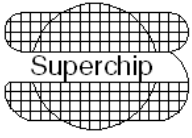

SC6928B(文件编号: S&CIC0460)

LED Driver IC

SG1	SG4 SG5	SG8 SG9	SG12
00HL	00Hu	01HL	DIG1
02HL	02Hu	03HL	DIG2
04HL	04Hu	05HL	DIG3
06HL	06Hu	07HL	DIG4
08HL	08Hu	09HL	DIG5
0AHL	0AHu	0BHL	DIG6
0CHL	0CHu	0DHL	DIG7

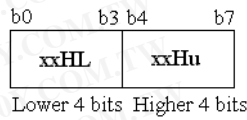

勝特力材料 886-3-5753170
 勝特力电子(上海) 86-21-54151736
 勝特力电子(深圳) 86-755-83298787
[Http://www.100y.com.tw](http://www.100y.com.tw)

Command 4: Display Control Commands

The Display Control Commands are used to turn ON or OFF a display. It also used to set the pulse width. Please refer to the diagram below. When the power is turned ON, a 1/16 Pulse width is selected and the displayed is turned OFF (the key scanning is started).

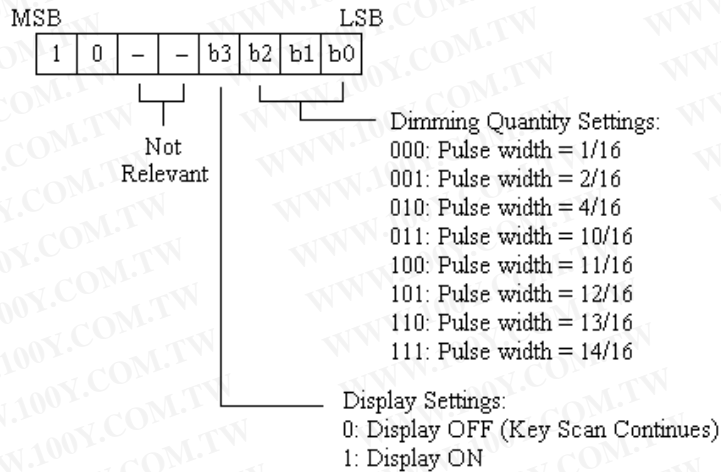

SCANNING AND DISPLAY TIMING

The key Scanning and Display Timing diagram is given below. One cycle of key scanning consists of 2 frames. The data of the are 10 x 3 matrix is stored in the RAM.

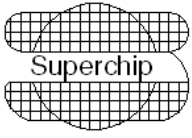

SC6928B (文件编号: S&CIC0460)

LED Driver IC

Tdisplay-500us

Key Scan Data

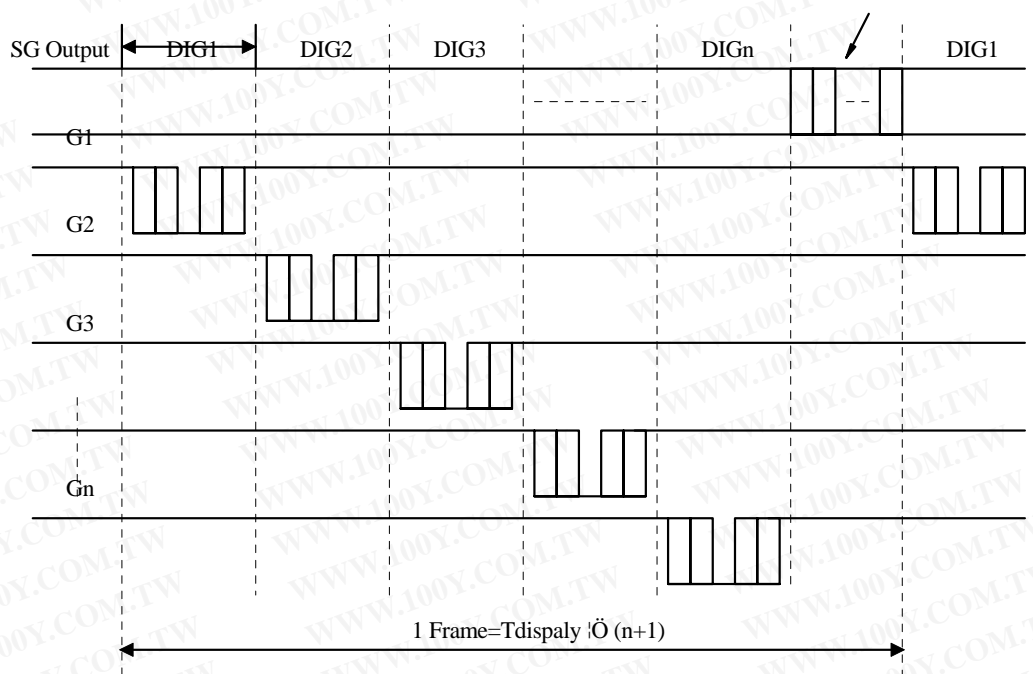

SERIAL COMMUNICATION FROMAT

The following diagram shows the SC6928B serial communication format. The DOUT Pin is an N-channel, opendrain output pin, therefore, it is highly recommended that an external pull-up resistor (1 KOhms to 10 KOhms) must be connected to DOUT.

RECEPTION (Data/Command Write)

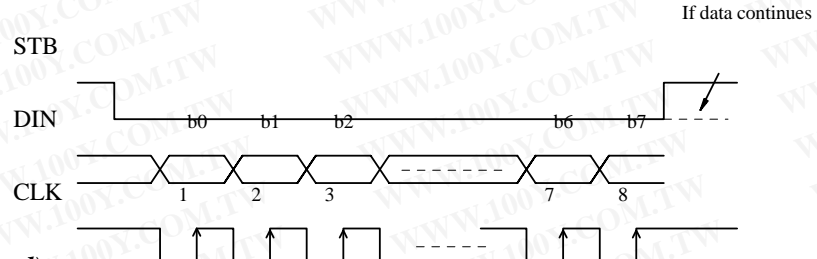

TRANSMISSION (Data Read)

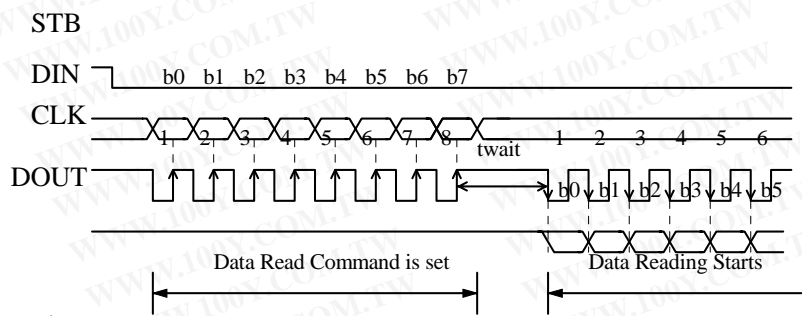

where: t_{wait} (waiting time) $\geq 1 \mu s$

It must be noted that when the data is read, the waiting time (t_{wait}) between the rising of the eighth clock that has set the

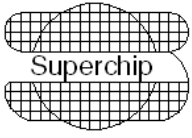

SC6928B(文件编号: S&CIC0460)

LED Driver IC

command and the falling of the first clock that has read the data is greater or equal to 1 μ s.

SWITCHING CHARACTERISTIC WAVEFORM

SC6928B Switching Characteristics Waveform is given below.

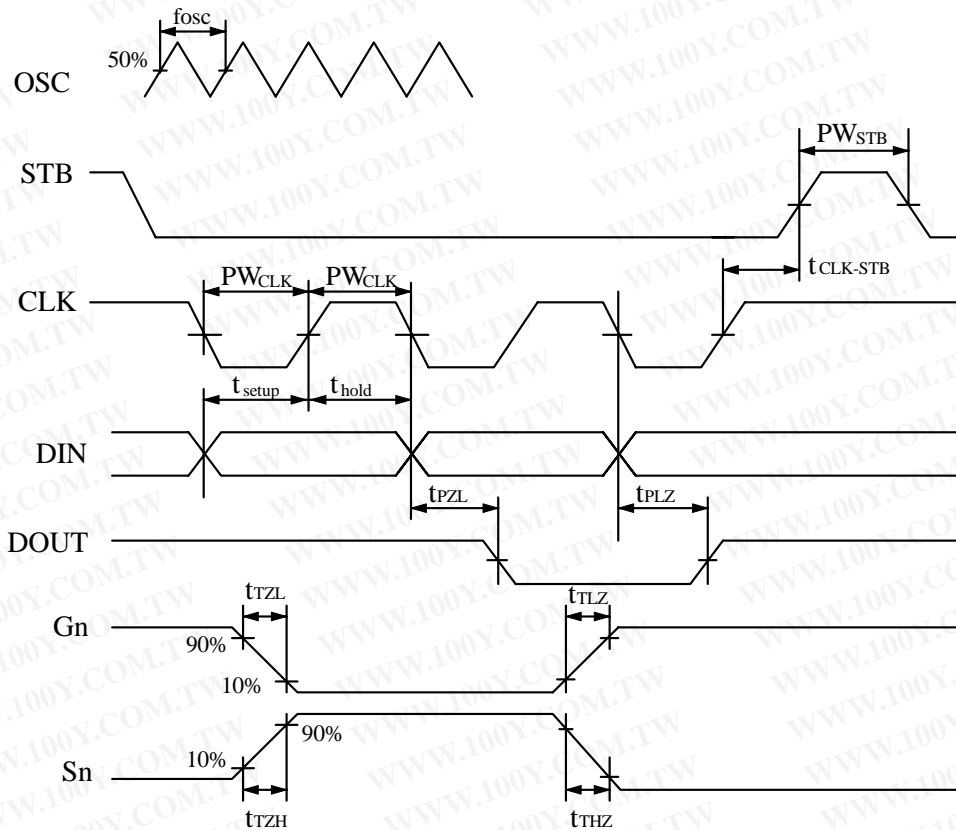

where: PW_{CLK} (Clock Pulse Width) $\geq 400nS$
 t_{setup} (Data Setup Time) $\geq 100nS$
 $t_{CLK-STB}$ (Clock-Strobe Time) $\geq 1 \mu s$
 t_{TZH} (Rise Time) $\leq 1 \mu s$
 f_{osc} =Oscillation Frequency
 $t_{TZL} < 1 \mu s$

PW_{STB} (Strobe Pulse Width) $\geq 1 \mu s$
 t_{hold} (Data Hold Time) $\geq 100nS$
 t_{TTHZ} (Fall Time) $\leq 10 \mu s$
 t_{PZL} (Propagation Delay Time) $\leq 100nS$
 t_{PLZ} (Propagation Delay Time) $\leq 300uS$
 $t_{TLZ} < 10 \mu s$

Note: Test condition under

t_{TTHZ} (Pull low resistor=100k ohms, Loading capacitor =300pf)

t_{TLZ} (Pull high resistor =100k ohms, Loading capacitor=300pf)

APPLICATIONS

Display memory is updated by incrementing addresses. Please refer to the following diagram.

勝特力材料 886-3-5753170
 勝特力电子(上海) 86-21-54151736
 勝特力电子(深圳) 86-755-83298787
[Http://www.100y.com.tw](http://www.100y.com.tw)

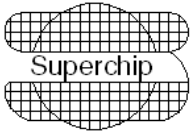

SC6928B(文件编号: S&CIC0460)

LED Driver IC

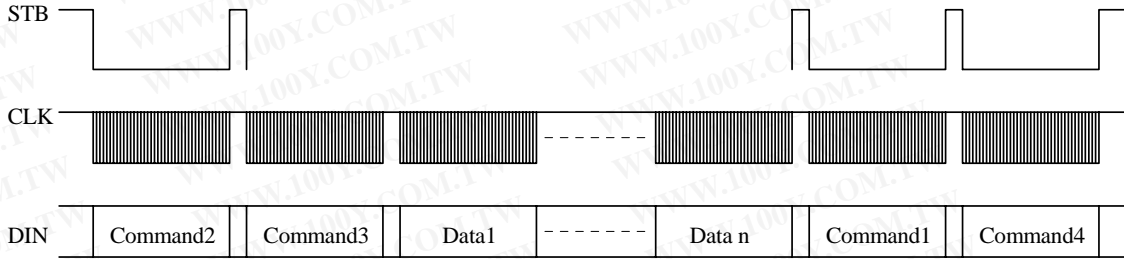

- where: Command 1: Display Mode Setting Command
- Command 2: Data Setting Command
- Command 3: Address Setting Command
- Data 1 to n : Transfer Display Data (14 Bytes max.)
- Command 4: Display Control Command

The following diagram shows the waveforms when updating specific addresses.

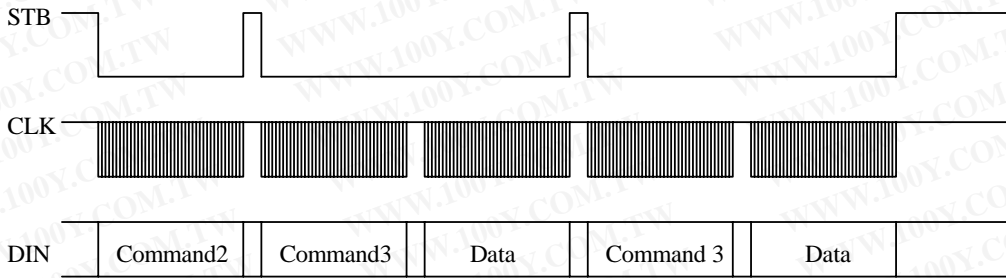

- where: Command 2 — Data Setting Command
- Command 3 — Address Setting Command
- Data — Display Data

勝特力材料 886-3-5753170
 勝特力电子(上海) 86-21-54151736
 勝特力电子(深圳) 86-755-83298787
[Http://www.100y.com.tw](http://www.100y.com.tw)

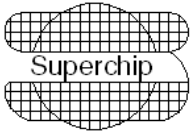

SC6928B(文件编号: S&CIC0460)

LED Driver IC

RECOMMENDED SOFTWARE PROGRAMMING FLOWCHART

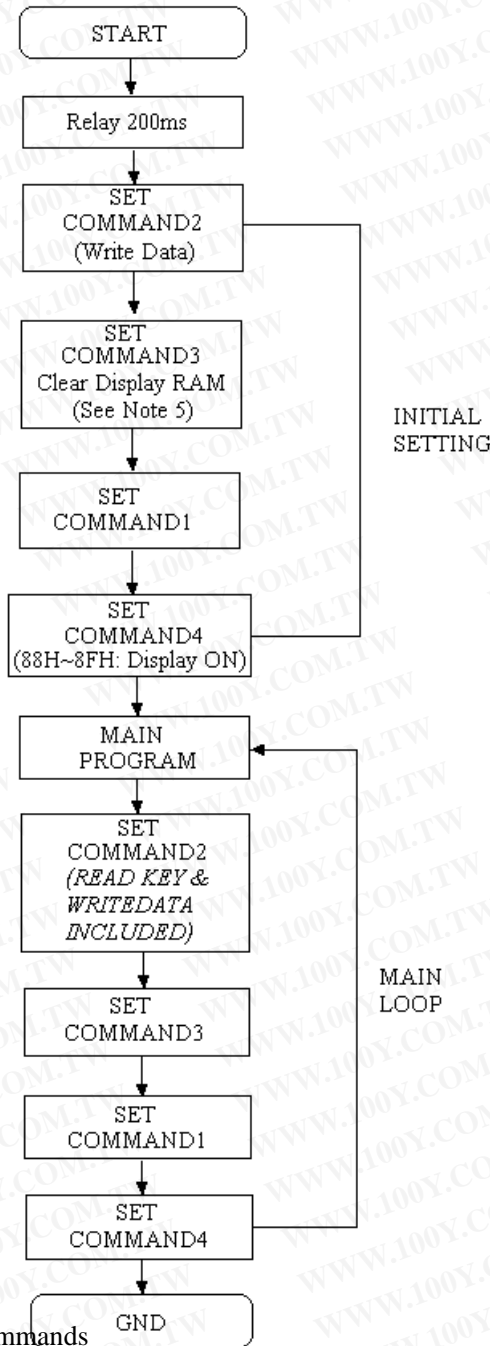

Note: 1. Command 1: Display Mode Commands

2. Command 2: Data Setting Commands

3. Command 3: Address Setting Commands

4. Command 4: Display Control Commands

5. When IC power is applied for the first time, the contents of the Display RAM is not defined; thus, it is strongly suggested that the contents of the Display RAM must be cleared during the initial setting.

勝特力材料 886-3-5753170
 勝特力电子(上海) 86-21-54151736
 勝特力电子(深圳) 86-755-83298787
[Http://www.100y.com.tw](http://www.100y.com.tw)

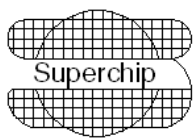

SC6928B (文件编号: S&CIC0460)

LED Driver IC

ABSOLUTE MAXIMUM RATINGS

(Unless otherwise stated, Ta=25°C, GND=0V)

Parameter	Symbol	Ratings	Unit
Supply Voltage	V _{DD}	-0.5 to +7	Volts
Logic Input Voltage	V _I	-0.5 to V _{DD} +0.5	Volts
Driver Output Current	I _{OLGR}	+250	mA
	I _{OHSG}	-50	mA
Maximum Driver Output Current/Total	I _{TOTAL}	400	mA

RECOMMENDED OPERATING RANGE

(Unless otherwise stated, Ta=-20 to +70°C, GND=0V)

Parameter	Symbol	Min.	Typ.	Max.	Unit
Logic Supply Voltage	V _{DD}	4.5	5	5.5	V
Dynamic Current (see Note)	I _{DDdyn}	-	-	10	mA
High-Level Input Voltage	V _{IH}	0.8V _{DD}	-	V _{DD}	V
Low-Level Input Voltage	V _{IL}	0	-	0.3V _{DD}	V

Note: Test Condition: Set Display Control Commands = 80H (Display Turn OFF State & under no load)

ELECTRICAL CHARACTERISTICS

(Unless otherwise stated, V_{DD}=5V, GND=0V, Ta=25°C)

Parameter	Symbol	Test Condition	Min.	Typ.	Max.	Unit
High-Level Output Current	IOHSG1	V _o =V _{DD} -2V SG1 to SG10, SG12/GR7	-20	-25	-40	mA
	IOHSG2	V _o =V _{DD} -3V SG1 to SG12, SG12/GR7	-25	-30	-50	mA
Low-Level Output Current	IOLGR	V _o =0.3V GR1 to GR6, SG12/GR7	100	140	-	mA
Low-Level Output Current	IOLDOUT	V _o =0.4V	4	-	-	mA
Segment High-Level	ITOLSG	V _o =V _{DD} -3V	-	-	±5	mA
Output Current Tolerance		SG1 to SG10, SG12/GR7				
High-Level Input Voltage	VIH	-	0.8 V _{DD}	-	5	V
Low-Level Input Voltage	VIL	-	0	-	0.3V _{DD}	V
Oscillation Frequency	fosc	R=33 KOhms	350	500	650	KHz
K1 to K2 Pull Down Resistor	RKN	K1 to K2	40	-	100	KOhms
		V _{DD} =5V				

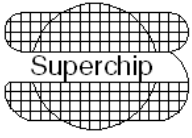

SC6928B (文件编号: S&CIC0460)

LED Driver IC

APPLICATION CIRCUIT

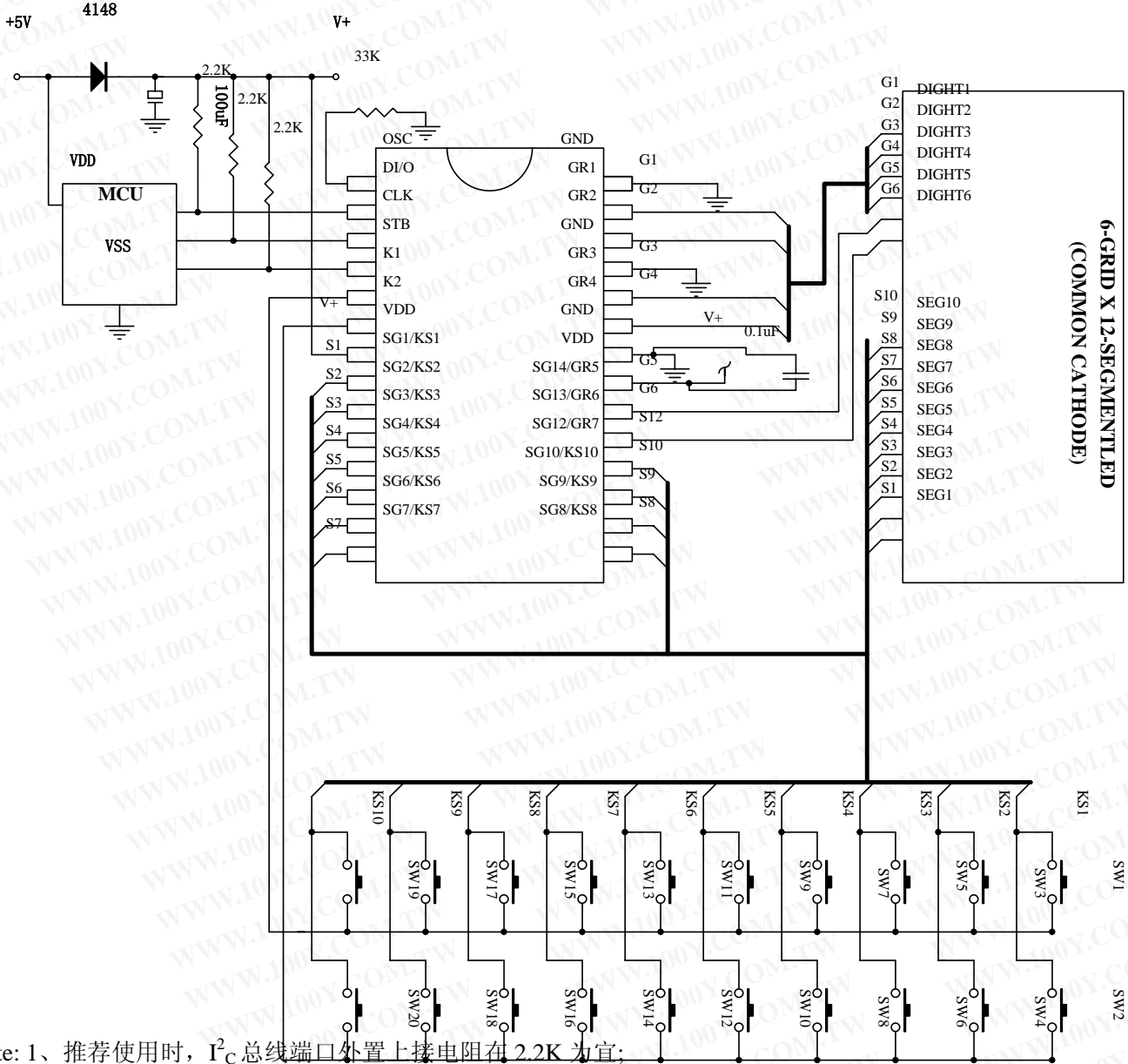

- Note: 1、推荐使用时， I_c 总线端口外置上接电阻在 2.2K 为宜；
 2、为降低系统信号的串扰，建议产品之 MCU 与 SC6928 供电之正极串接 4148 二极管隔离。

勝特力材料 886-3-5753170
勝特力电子(上海) 86-21-54151736
勝特力电子(深圳) 86-755-83298787
[Http://www.100y.com.tw](http://www.100y.com.tw)

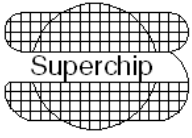

SC6928B(文件编号: S&CIC0460)

LED Driver IC

COMMON CATHODE TYPE LED PANEL:

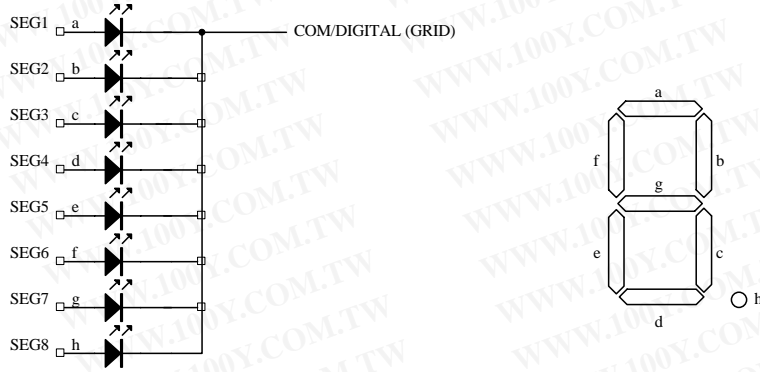

- Note: 1、 The capacitor (0.1uF) connected between the GND and the VDD pins must be located as close as possible to the SC6928B chip.
2、 The SC6928B power supply is separate from the application system power supply.

勝特力材料 886-3-5753170
勝特力电子(上海) 86-21-54151736
勝特力电子(深圳) 86-755-83298787
[Http://www.100y.com.tw](http://www.100y.com.tw)