

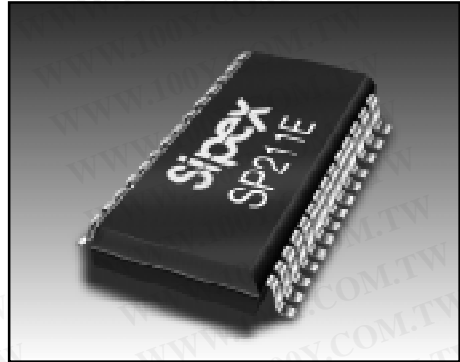

SP207E–SP213E

+5V High Performance RS232 Transceivers

- Single +5V Supply Operation
- 0.1 μ F External Charge Pump Capacitors
- Typical 230kbps Transmission Rates
- Standard SOIC and SSOP Packages
- Lower Supply Current Than Competition (typical 3mA)
- 1 μ A Shutdown Mode
- WakeUp Feature in Shutdown Mode
- Tri-State Receiver Outputs
- Meets All EIA-232 and ITU V.28 Specifications
- Improved ESD Specifications:
 - +15kV Human Body Model
 - +15kV IEC1000-4-2 Air Discharge
 - +8kV IEC1000-4-2 Contact Discharge



勝特力材料 886-3-5753170
 勝特力电子(上海) 86-21-34970699
 勝特力电子(深圳) 86-755-83298787
[Http://www.100y.com.tw](http://www.100y.com.tw)

DESCRIPTION

The **SP200E Series** are enhanced multi-channel RS-232 line transceivers with improved electrical performance. The **SP200E** family is pin-to-pin compatible with our previous SP200 family as well as popular industry standards. As with the original SP200 family, all models in this Series feature low-power CMOS construction and **Sipex**-patented (5,306,954) on-board charge pump circuitry to generate the $\pm 10V$ RS-232 voltage levels, using 0.1 μ F charge pump capacitors to save board space and reduce circuit cost. The **SP211E** and **SP213E** models feature a low-power shutdown mode, which reduces power supply drain to 1 μ A. Enhancements include lower power supply current at 3mA typical (no load) and superior ESD performance. The ESD tolerance has been improved on this family to over $\pm 15kV$ for both Human Body Model and IEC1000-4-2 Air Discharge test methods.

Model	Number of RS232		No. of Receivers Active in Shutdown	No. of External 0.1 μ F Capacitors	Shutdown	WakeUp	TTL Tri-State
	Drivers	Receivers					
SP207E	5	3	0	4	No	No	No
SP208E	4	4	0	4	No	No	No
SP211E	4	5	0	4	Yes	No	Yes
SP213E	4	5	2	4	Yes	Yes	Yes

Table 1. Model Selection Table

ABSOLUTE MAXIMUM RATINGS

These are stress ratings only and functional operation of the device at these or any other above those indicated in the operation sections of the specifications below is not implied. Exposure to absolute maximum rating conditions for extended periods of time may affect reliability.

V_{CC}	+6V
V^+	($V_{CC} - 0.3V$) to +13.2V
V^-	13.2V
Input Voltages	
T_{IN}	-0.3V to ($V_{CC} + 0.3V$)
R_{IN}	$\pm 20V$
Output Voltages	
T_{OUT}	(V^+ , +0.3V) to (V^- , -0.3V)
R_{OUT}	-0.3V to ($V_{CC} + 0.3V$)
Short Circuit Duration on T_{OUT}	Continuous

Power Dissipation Per Package

24-pin SSOP (derate 11.2mW/°C above +70°C)....900mW
 24-pin PDIP (derate 15.9mW/°C above +70°C)....1300mW
 24-pin SOIC (derate 12.5mW/°C above +70°C)....1000mW
 28-pin SSOP (derate 11.2mW/°C above +70°C)....900mW
 28-pin SOIC (derate 12.7mW/°C above +70°C)....1000mW

勝 特 力 材 料 886-3-5753170
勝 特 力 电 子 (上 海) 86-21-34970699
勝 特 力 电 子 (深 圳) 86-755-83298787
Http://www.100y.com.tw

SPECIFICATIONS

V_{CC} at nominal ratings; 0.1 μ F charge pump capacitors; T_{MIN} to T_{MAX} unless otherwise noted.

PARAMETER	MIN.	TYP.	MAX.	UNIT	CONDITIONS
TTL INPUTS					
Logic Threshold			0.8	Volts	T_{IN} , EN, SD
V_{IL}	2.0			Volts	
V_{IH}				Volts	
Logic Pullup Current		15	200	μ A	$T_{IN} = 0V$
Maximum Transmission Rate	120	230		kbps	$C_L = 1000pF$, $R_L = 3K\Omega$
TTL OUTPUTS					
Compatibility		TTL/CMOS			
V_{OL}	3.5		0.4	Volts	$I_{OUT} = 3.2mA$; $V_{CC} = +5V$
V_{OH}				Volts	$I_{OUT} = -1.0mA$
Leakage Current		0.05	± 10	μ A	$0V \leq R_{OUT} \leq V_{CC}$; SP211 $\overline{EN} = 0V$; SP213 $EN = V_{CC}$
RS232 OUTPUT					
Output Voltage Swing	± 5	± 7		Volts	All transmitter outputs loaded with 3K Ω to ground
Output Resistance	300			Ω	$V_{CC} = 0V$; $V_{OUT} = \pm 2V$
Output Short Circuit Current		± 25		mA	Infinite duration, $V_{OUT} = 0V$
RS232 INPUT					
Voltage Range	-15		+15	Volts	
Voltage Threshold					
Low	0.8	1.2		Volts	$V_{CC} = 5V$, $T_A = +25^\circ C$
High		1.7	2.8	Volts	$V_{CC} = 5V$, $T_A = +25^\circ C$
Hysteresis	0.2	0.5	1.0	Volts	$V_{CC} = +5V$
Resistance	3	5	7	k Ω	$V_{IN} = \pm 15V$; $T_A = +25^\circ C$
DYNAMIC CHARACTERISTICS					
Driver Propagation Delay		1.5		μ s	TTL-to-RS-232
Receiver Propagation Delay		0.5	1.5	μ s	RS-232-to-TTL
Instantaneous Slew Rate			30	V/ μ s	$C_L = 50pF$, $R_L = 3-7K\Omega$; $T_A = +25^\circ C$; from $\pm 3V$
Transition Time			1.5	μ s	$C_L = 2,500pF$, $R_L = 3K\Omega$; measured from +3V to -3V or -3V to +3V
Output Enable Time		400		ns	
Output Disable Time		250		ns	

SPECIFICATIONS

V_{CC} at nominal ratings; 0.1 μ F charge pump capacitors; T_{MIN} to T_{MAX} , unless otherwise noted.

PARAMETER	MIN.	TYP.	MAX.	UNIT	CONDITIONS
POWER REQUIREMENTS					
V_{CC} SP207	4.75	5.00	5.25	Volts	$T_A = +25^\circ\text{C}$ No load; $V_{CC} = \pm 10\%$ All transmitters $R_L = 3\text{K}\Omega$ $T_A = +25^\circ\text{C}$
All other parts	4.50	5.00	5.50	Volts	
I_{CC}		3	6	mA	
Shutdown Current		15	10	mA	
		1	10	μA	
ENVIRONMENTAL AND MECHANICAL					
Operating Temperature					
Commercial, -C	0		+70	$^\circ\text{C}$	
Extended, -E	-40		+85	$^\circ\text{C}$	
Storage Temperature	-65		+125	$^\circ\text{C}$	
Package					
-A	Shrink (SSOP) small outline				
-T	Wide (SOIC) small outline				
-P	Narrow (PDIP) Plastic Dual-In-Line				

勝特力材料 886-3-5753170
勝特力电子(上海) 86-21-34970699
勝特力电子(深圳) 86-755-83298787
[Http://www.100y.com.tw](http://www.100y.com.tw)

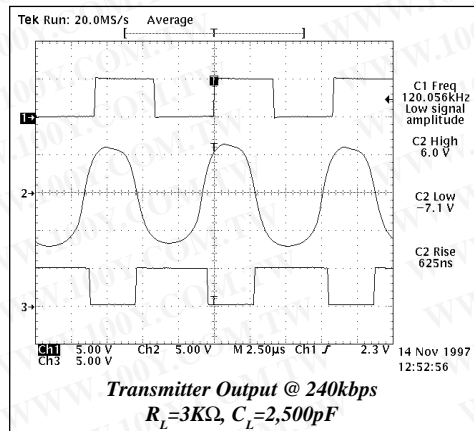
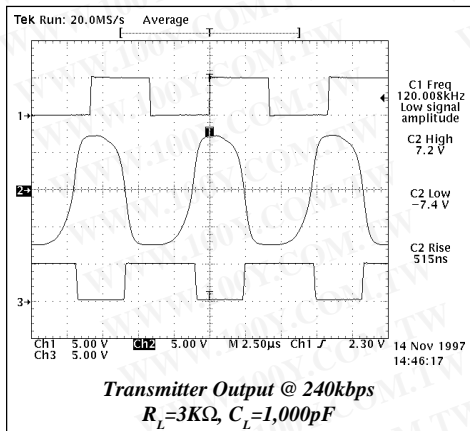
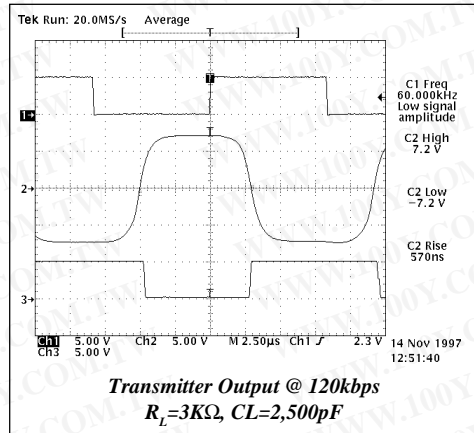
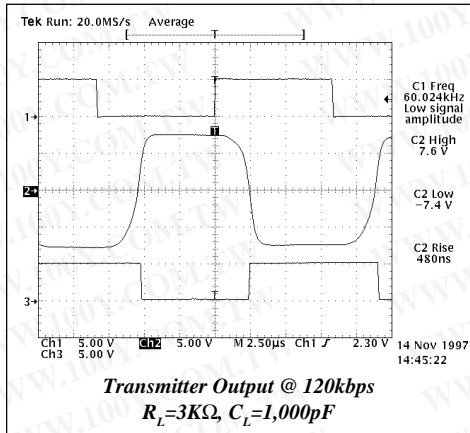

PINOUT

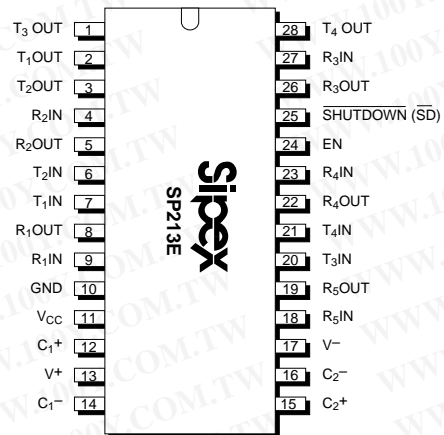
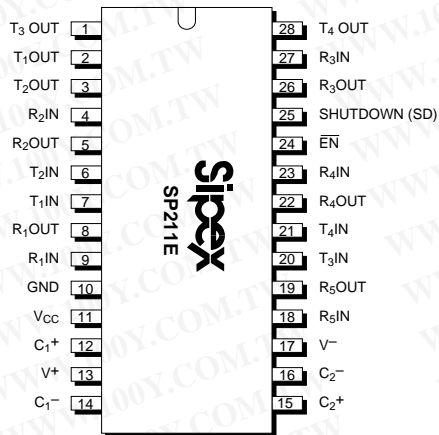
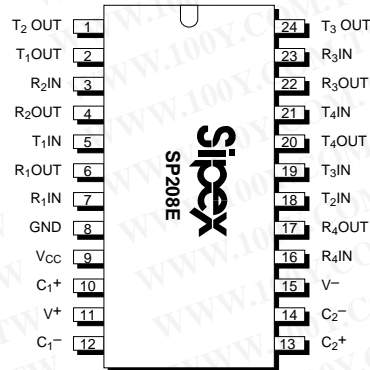
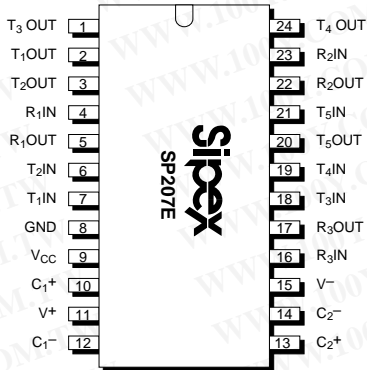

勝特力材料 886-3-5753170
 勝特力电子(上海) 86-21-34970699
 勝特力电子(深圳) 86-755-83298787
[Http://www.100y.com.tw](http://www.100y.com.tw)

FEATURES

As in the original RS-232 multi-channel products, the **SP207E Series** multi-channel RS-232 line transceivers provide a variety of configurations to fit most communication needs, especially those applications where $\pm 12\text{V}$ is not available. All models in this Series feature low-power CMOS construction and **SIPEX**—proprietary on-board charge pump circuitry to generate the $\pm 10\text{V}$ RS-232 voltage levels. The ability to use $0.1\mu\text{F}$ charge pump capacitors saves board space and reduces circuit cost. Different models within the Series provide different driver/receiver combinations to match any application requirement.

The **SP211** and **SP213E** models feature a low-power shutdown mode, which reduces power supply drain to $1\mu\text{A}$. The **SP213E** includes a Wake-Up function which keeps two receivers active in the shutdown mode, unless disabled by the EN pin.

The family is available in 28-pin SO (wide) and SSOP (shrink) small outline packages. Devices can be specified for commercial (0°C to $+70^\circ\text{C}$) and industrial/extended (-40°C to $+85^\circ\text{C}$) operating temperatures.

THEORY OF OPERATION

The **SP207E Series** devices are made up of three basic circuit blocks — 1) transmitter/driver, 2) receiver and 3) the **SIPEX**—proprietary charge pump. Each model within the Series incorporates variations of these circuits to achieve the desired configuration and performance.

Charge-Pump

The charge pump is a **Sipex**—patented design (5,306,954) and uses a unique approach compared to older less-efficient designs. The charge pump still requires four external capacitors, but uses a four-phase voltage shifting technique to attain symmetrical 10V power supplies. *Figure 3a* shows the waveform found on the positive side of capacitor C_2 , and *Figure 3b* shows the negative side of capacitor C_2 . There is a free-running oscillator that controls the four phases of the voltage shifting. A description of each phase follows.

Phase 1

— V_{SS} charge storage — During this phase of the clock cycle, the positive side of capacitors C_1 and C_2 are initially charged to $+5\text{V}$. C_1^+ is then switched to ground and the charge in C_1^- is transferred to C_2^- . Since C_2^+ is connected to $+5\text{V}$, the voltage potential across capacitor C_2 is now 10V .

Phase 2

— V_{SS} transfer — Phase two of the clock connects the negative terminal of C_2 to the V_{SS} storage capacitor and the positive terminal of C_2 to ground, and transfers the generated -10V to C_3 . Simultaneously, the positive side of capacitor C_1 is switched to $+5\text{V}$ and the negative side is connected to ground.

Phase 3

— V_{DD} charge storage — The third phase of the clock is identical to the first phase — the charge transferred in C_1 produces -5V in the negative terminal of C_1 , which is applied to the negative side of capacitor C_2 . Since C_2^+ is at $+5\text{V}$, the voltage potential across C_2 is 10V .

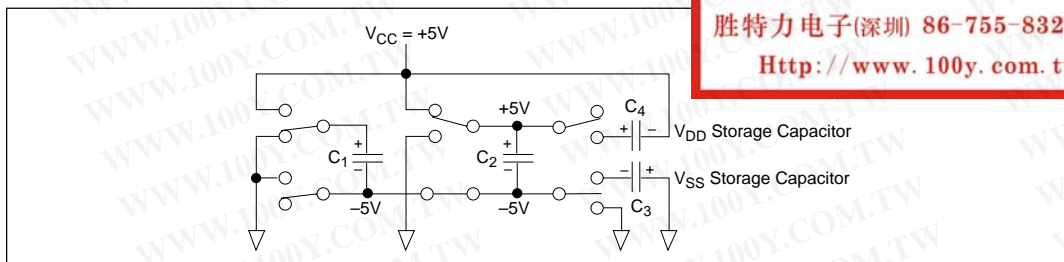

Figure 1. Charge Pump — Phase 1

勝特力材料 886-3-5753170
勝特力电子(上海) 86-21-34970699
勝特力电子(深圳) 86-755-83298787
[Http://www.100y.com.tw](http://www.100y.com.tw)

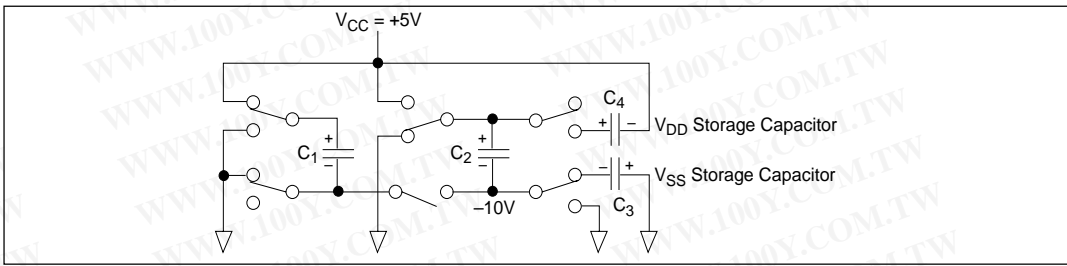

Figure 2. Charge Pump — Phase 2

Phase 4

— V_{DD} transfer — The fourth phase of the clock connects the negative terminal of C_2 to ground, and transfers the generated 10V across C_2 to C_4 , the V_{DD} storage capacitor. Again, simultaneously with this, the positive side of capacitor C_1 is switched to +5V and the negative side is connected to ground, and the cycle begins again.

Since both V^+ and V^- are separately generated from V_{CC} ; in a no-load condition V^+ and V^- will be symmetrical. Older charge pump approaches that generate V^- from V^+ will show a decrease in the magnitude of V^- compared to V^+ due to the inherent inefficiencies in the design.

The clock rate for the charge pump typically operates at 15kHz. The external capacitors can be as low as 0.1 μ F with a 16V breakdown voltage rating.

Transmitter/Driver

The drivers are inverting transmitters, which accept either TTL or CMOS inputs and output the RS-232 signals with an inverted sense relative to the input logic levels. Typically, the RS-232 output voltage swing is +9V with no load, and +5V minimum with full load. The transmitter outputs are protected against infinite short-circuits to ground without degradation in reliability. The drivers of the **SP211E**, and **SP213E** can be tri-stated by using the SHUTDOWN function.

In the “power-off” state, the output impedance will remain greater than 300 ohms, again satisfying the RS-232 specifications. Should the input of the driver be left open, an internal 400Kohm pullup resistor to V_{CC} forces the input high, thus committing the output to a low state. The slow rate of the transmitter output is internally limited to a maximum of 30V/ μ s in order to meet the EIA standards (EIA RS-232D 2.1.7, Paragraph 5). The transition of the loaded output from high to low also meets the monotonicity requirements of the standard.

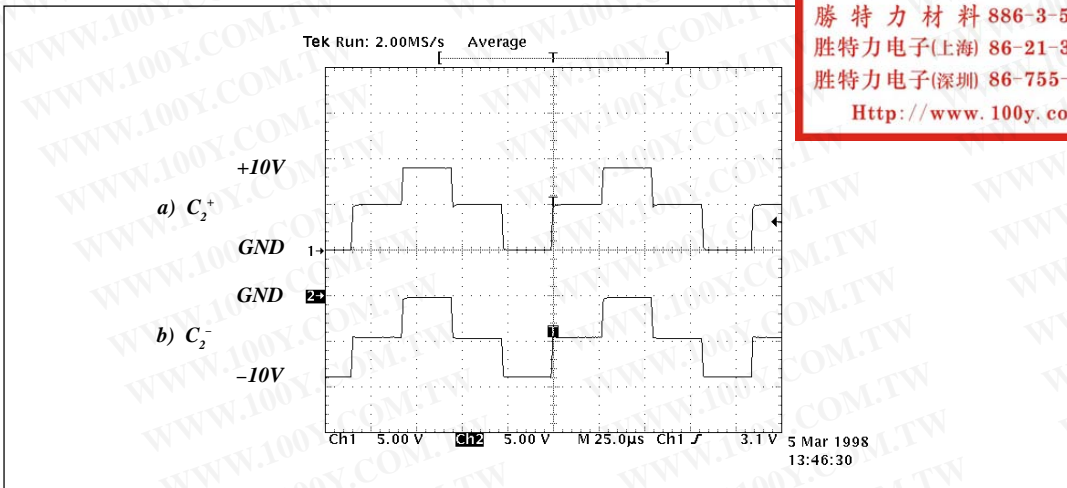

勝特力材料 886-3-5753170
 勝特力电子(上海) 86-21-34970699
 勝特力电子(深圳) 86-755-83298787
[Http://www.100y.com.tw](http://www.100y.com.tw)

Figure 3. Charge Pump Waveforms

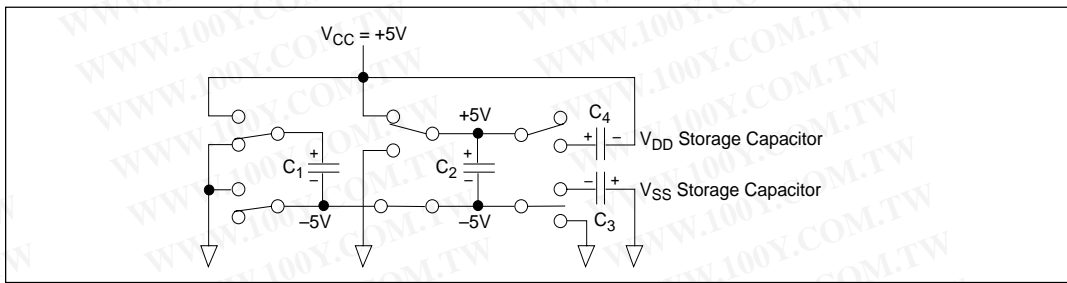

Figure 4. Charge Pump — Phase 3

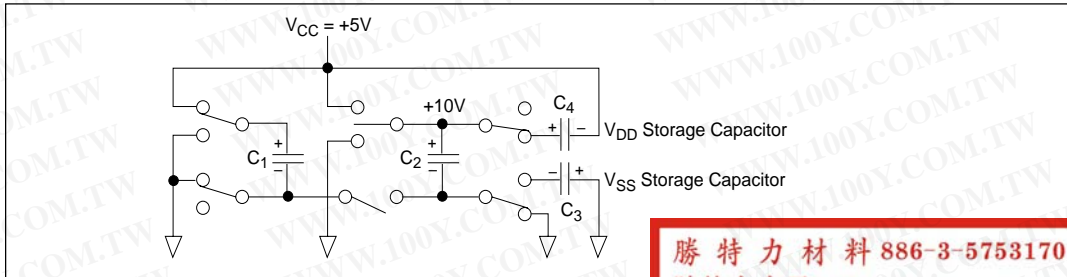

Figure 5. Charge Pump — Phase 4

勝特力材料 886-3-5753170
 勝特力电子(上海) 86-21-34970699
 勝特力电子(深圳) 86-755-83298787
[Http://www.100y.com.tw](http://www.100y.com.tw)

Receivers

The receivers convert RS-232 input signals to inverted TTL signals. Since the input is usually from a transmission line where long cable lengths and system interference can degrade the signal, the inputs have a typical hysteresis margin of 500mV. This ensures that the receiver is virtually immune to noisy transmission lines. Should an input be left unconnected, a 5kΩ pull-down resistor to ground will commit the output of the receiver to a high state.

SHUTDOWN MODE

The SP211E, and SP213E all feature a control input which will disable the device and reduce the power supply current to less than 10μA, making the parts ideal for battery-powered systems. In the “shutdown” mode the receivers and transmitters will both be tri-stated. The V⁺ output of the charge pump will discharge to V_{CC}, and the V⁻ output will discharge to ground. Products with the Wake-Up function can enable or disable the receivers during shutdown.

For complete shutdown to occur and the 10μA power drain to be realized, the following conditions must be met:

SP211E:

- +5V must be applied to the SD pin
- ENABLE must be either 0V, +5.0V or not connected
- the transmitter inputs must be either +5.0V or not connected
- V_{CC} must be +5V
- Receiver inputs must be >0V and <+5V

SP213E:

- 0V must be applied to the $\overline{\text{SD}}$ pin
- ENABLE must be either 0V, +5.0V or not connected
- the transmitter inputs must be either +5.0V or not connected
- V_{CC} must be +5V
- Receiver inputs must be >0V and <+5V

ENABLE

The **SP211E** and **SP213E** all feature an enable input, which allows the receiver outputs to be either tri-stated or enabled. This can be especially useful when the receiver is tied directly to a microprocessor data bus. For the **SP211E**, enable is active low; that is, 0V applied to the ENABLE pin will enable the receiver outputs. For the **SP213E**, enable is active high; that is, +5V applied to the ENABLE pin will enable the receiver outputs.

SD	SP213E Only		Power Up/Down	Receiver Outputs	
	EN	SD			EN
0	0	1	1	Up	Enable
0	1	1	0	Up	Tri-state
1	0	0	1	Down	Enable
1	1	0	0	Down	Tri-state

Table 2. Wake-Up Truth Table

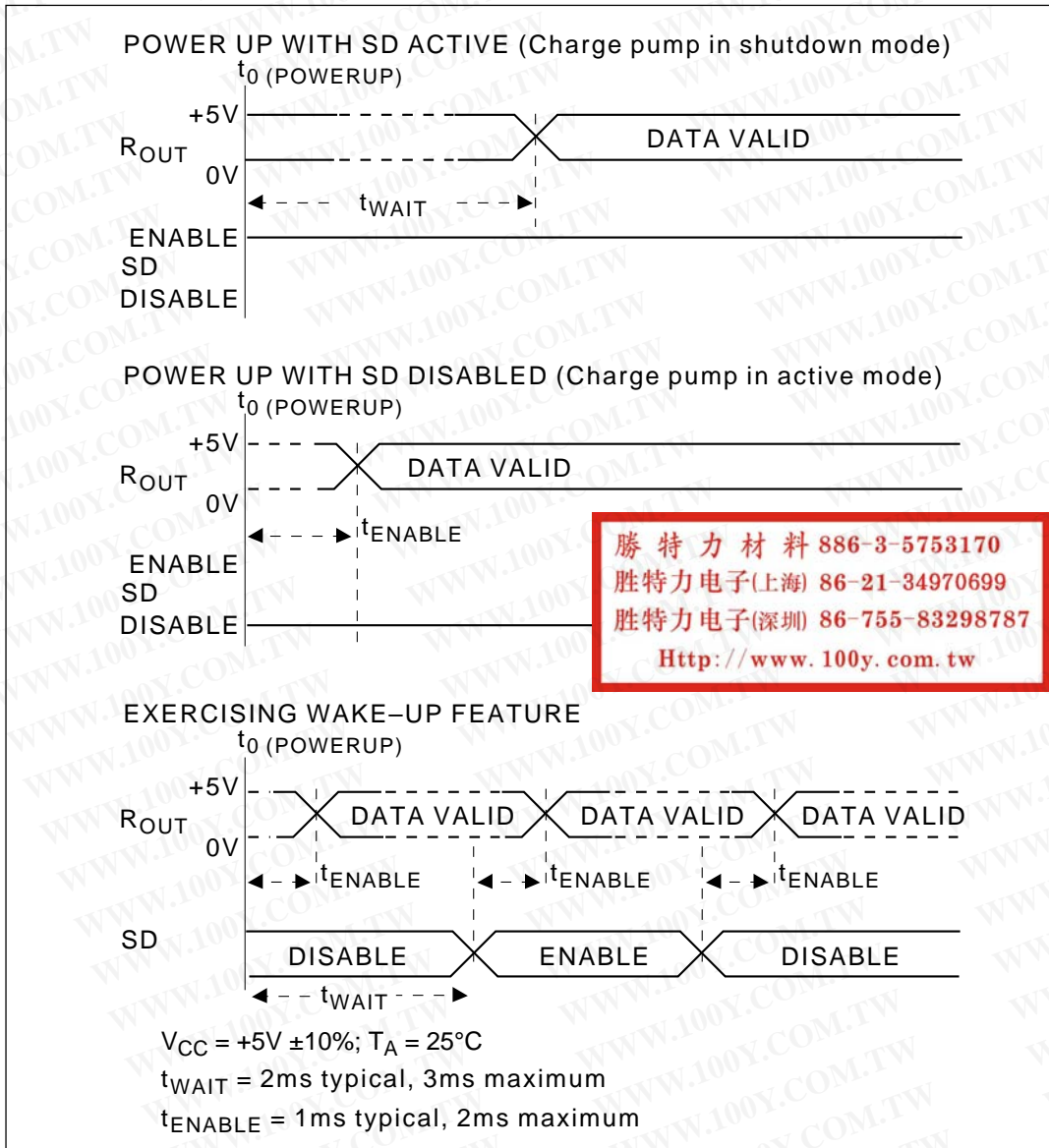

Figure 6. Wake-Up Timing

WAKEUP FUNCTION

The **SP213E** has a wake-up feature that keeps two receivers (R_4 and R_5) in an enabled state when the device is in the shutdown mode. With only the receivers active during shutdown, the devices draw 5–10 μ A of supply current.

A typical application of this function would be where a modem is interfaced to a computer in a power-down mode. The ring indicator signal from the modem could be passed through an active receiver in the **SP213E** that is itself in the shutdown mode. The ring indicator signal would propagate through the **SP213E** to the power management circuitry of the computer to power up the microprocessor and the **SP213E** drivers. After the supply voltage to the **SP213E** reaches +5.0V, the SHUTDOWN pin can be disabled, taking the **SP213E** out of the shutdown mode.

All receivers that are active during shutdown maintain 500mV (typ.) of hysteresis.

ESD TOLERANCE

The **SP207E** Family incorporates ruggedized ESD cells on all driver output and receiver input pins. The ESD structure is improved over our previous family for more rugged applications and environments sensitive to electro-static discharges and associated transients. The improved ESD tolerance is at least ± 15 kV without damage nor latch-up.

There are different methods of ESD testing applied:

- MIL-STD-883, Method 3015.7
- IEC1000-4-2 Air-Discharge
- IEC1000-4-2 Direct Contact

The Human Body Model has been the generally accepted ESD testing method for semiconductors. This method is also specified in MIL-STD-883, Method 3015.7 for ESD testing. The premise of this ESD test is to simulate the human body's potential to store electro-static energy and discharge it to an integrated circuit. The simulation is performed by using a test model as shown in *Figure 7*. This method will test the IC's capability to withstand an ESD transient during normal handling such as in manufacturing areas where the ICs tend to be handled frequently.

The IEC-1000-4-2, formerly IEC801-2, is generally used for testing ESD on equipment and systems. For system manufacturers, they must guarantee a certain amount of ESD protection since the system itself is exposed to the outside environment and human presence. The premise with IEC1000-4-2 is that the system is required to withstand an amount of static electricity when ESD is applied to points and surfaces of the equipment that are accessible to personnel during normal usage. The transceiver IC receives most of the ESD current when the ESD source is applied to the connector pins. The test circuit for IEC1000-4-2 is shown in *Figure 8*. There are two methods within IEC1000-4-2, the Air Discharge method and the Contact Discharge method.

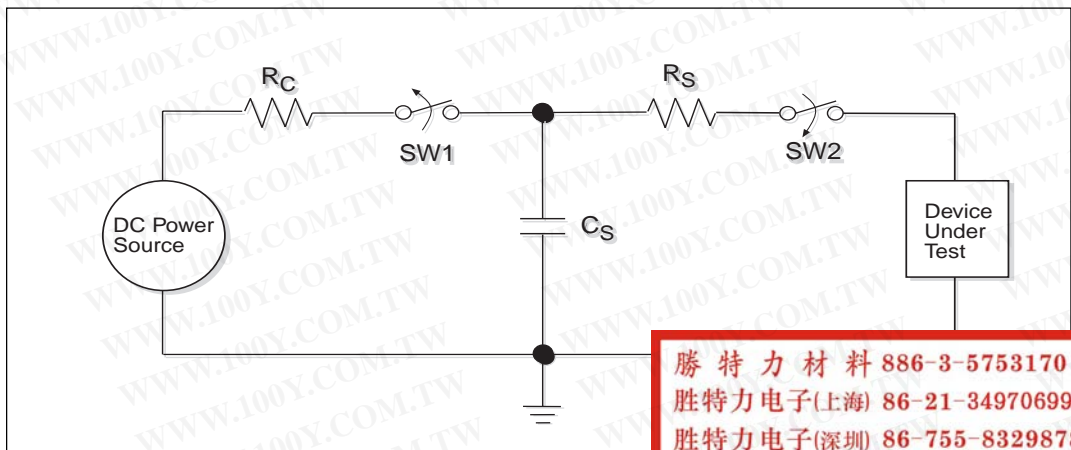

Figure 7. ESD Test Circuit for Human Body Model

勝特力材料 886-3-5753170
勝特力电子(上海) 86-21-34970699
勝特力电子(深圳) 86-755-83298787
[Http://www.100y.com.tw](http://www.100y.com.tw)

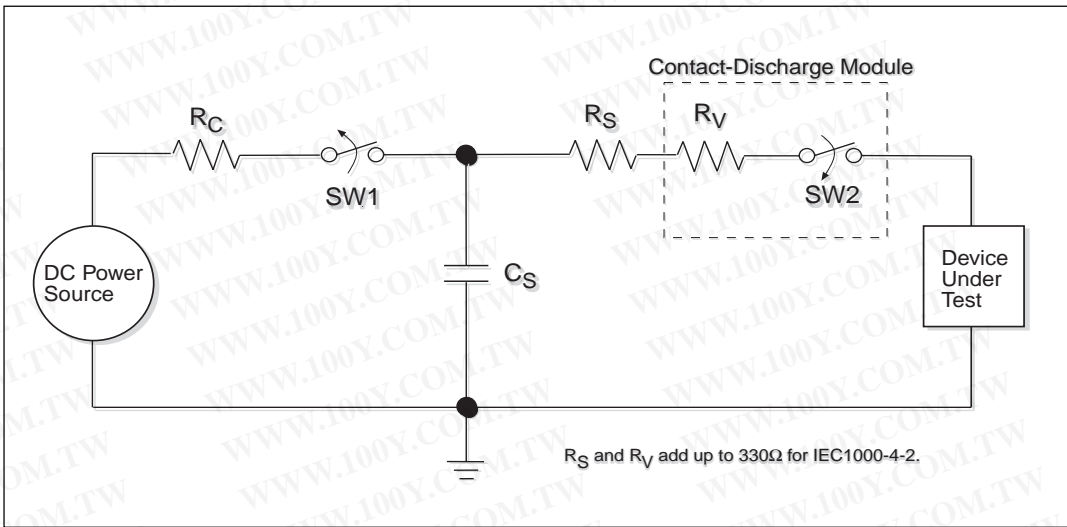

Figure 8. ESD Test Circuit for IEC1000-4-2

With the Air Discharge Method, an ESD voltage is applied to the equipment under test (EUT) through air. This simulates an electrically charged person ready to connect a cable onto the rear of the system only to find an unpleasant zap just before the person touches the back panel. The high energy potential on the person discharges through an arcing path to the rear panel of the system before he or she even touches the system. This energy, whether discharged directly or through air, is predominantly a function of the discharge current rather than the discharge voltage. Variables with an air discharge such as approach speed of the object carrying the ESD potential to the system and humidity will tend to change the discharge current. For example, the rise time of the discharge current varies with the approach speed.

The Contact Discharge Method applies the ESD current directly to the EUT. This method was devised to reduce the unpredictability of the ESD arc. The discharge current rise time is constant since the energy is directly transferred without the air-gap arc. In situations such as hand held systems, the ESD charge can be directly discharged to the equipment from a person already holding the equipment. The current is transferred on to the keypad or the serial port of the equipment directly and then travels through the PCB and finally to the IC.

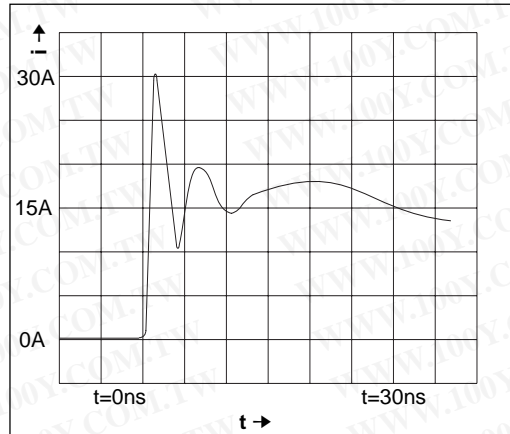

Figure 9. ESD Test Waveform for IEC1000-4-2

The circuit model in Figures 7 and 8 represent the typical ESD testing circuit used for all three methods. The C_S is initially charged with the DC power supply when the first switch ($SW1$) is on. Now that the capacitor is charged, the second switch ($SW2$) is on while $SW1$ switches off. The voltage stored in the capacitor is then applied through R_S , the current limiting resistor, onto the device under test (DUT). In ESD tests, the $SW2$ switch is pulsed so that the device under test receives a duration of voltage.

勝特力材料 886-3-5753170
 勝特力电子(上海) 86-21-34970699
 勝特力电子(深圳) 86-755-83298787
[Http://www.100y.com.tw](http://www.100y.com.tw)

For the Human Body Model, the current limiting resistor (R_s) and the source capacitor (C_s) are 1.5k Ω and 100pF, respectively. For IEC-1000-4-2, the current limiting resistor (R_s) and the source capacitor (C_s) are 330 Ω and 150pF, respectively.

The higher C_s value and lower R_s value in the IEC1000-4-2 model are more stringent than the Human Body Model. The larger storage capacitor injects a higher voltage to the test point when SW2 is switched on. The lower current limiting resistor increases the current charge onto the test point.

EIA STANDARDS

The Electronic Industry Association (EIA) developed several standards of data transmission which are revised and updated in order to meet the requirements of the industry. In data processing, there are two basic means of communicating between systems and components. The RS-232 standard was first introduced in 1962 and, since that time, has become an industry standard.

The RS-232 is a relatively slow data exchange protocol, with a maximum baud rate of only 20kbps, which can be transmitted over a maximum copper wire cable length of 50 feet. The **SP207E** through **SP213E** Series of data communications interface products have been designed to meet both the EIA protocol standards, and the needs of the industry.

勝特力材料 886-3-5753170
勝特力电子(上海) 86-21-34970699
勝特力电子(深圳) 86-755-83298787
[Http://www.100y.com.tw](http://www.100y.com.tw)

DEVICE PIN TESTED	HUMAN BODY MODEL	IEC1000-4-2		
		Air Discharge	Direct Contact	Level
Driver Outputs	$\pm 15kV$	$\pm 15kV$	$\pm 8kV$	4
Receiver Inputs	$\pm 15kV$	$\pm 15kV$	$\pm 8kV$	4

Table 3. Transceiver ESD Tolerance Levels

Specification	RS-232D	RS-423A	RS-422	RS-485	RS-562
Mode of Operation	Single-Ended	Single-Ended	Differential	Differential	Single-Ended
No. of Drivers and Receivers Allowed on One Line	1 Driver 1 Receiver	1 Driver 10 Receivers	1 Driver 10 Receivers	32 Drivers 32 Receivers	1 Driver 1 Receiver
Maximum Cable Length	50 feet	4,000 feet	4,000 feet	4,000 feet	$C \leq 2,500pF @ <20Kbps$; $C \leq 1,000pF @ >20Kbps$
Maximum Data Rate	20Kb/s	100Kb/s	10Mb/s	10Mb/s	64Kb/s
Driver output Maximum Voltage	$\pm 25V$	$\pm 6V$	-0.25V to +6V	-7V to +12V	-3.7V to +13.2V
Driver Output Signal Level Loaded Unloaded	$\pm 5V$ $\pm 15V$	$\pm 3.6V$ $\pm 6V$	$\pm 2V$ $\pm 5V$	$\pm 1.5V$ $\pm 5V$	$\pm 3.7V$ $\pm 13.2V$
Driver Load Impedance	3 – 7Kohm	450 ohm	100 ohm	54 ohm	3-7Kohm
Max. Driver Output Current (High Impedance State) Power On Power Off	$V_{MAX}/300$	100 μA	$\pm 100\mu A$	$\pm 100\mu A$	
Slew Rate	30V/ μs max.	Controls Provided			30V/ μs max.
Receiver Input Voltage Range	$\pm 15V$	$\pm 12V$	-7V to +7V	-7V to +12V	$\pm 15V$
Receiver Input Sensitivity	$\pm 3V$	$\pm 200mV$	$\pm 200mV$	$\pm 200mV$	$\pm 3V$
Receiver Input Resistance	3-7Kohm	4Kohm min.	4Kohm min.	12Kohm min.	3-7Kohm

Table 4. EIA Standard Definitions

TYPICAL APPLICATION CIRCUITS...SP207E TO SP213E

勝特力材料 886-3-5753170
 勝特力电子(上海) 86-21-34970699
 勝特力电子(深圳) 86-755-83298787
[Http://www.100y.com.tw](http://www.100y.com.tw)

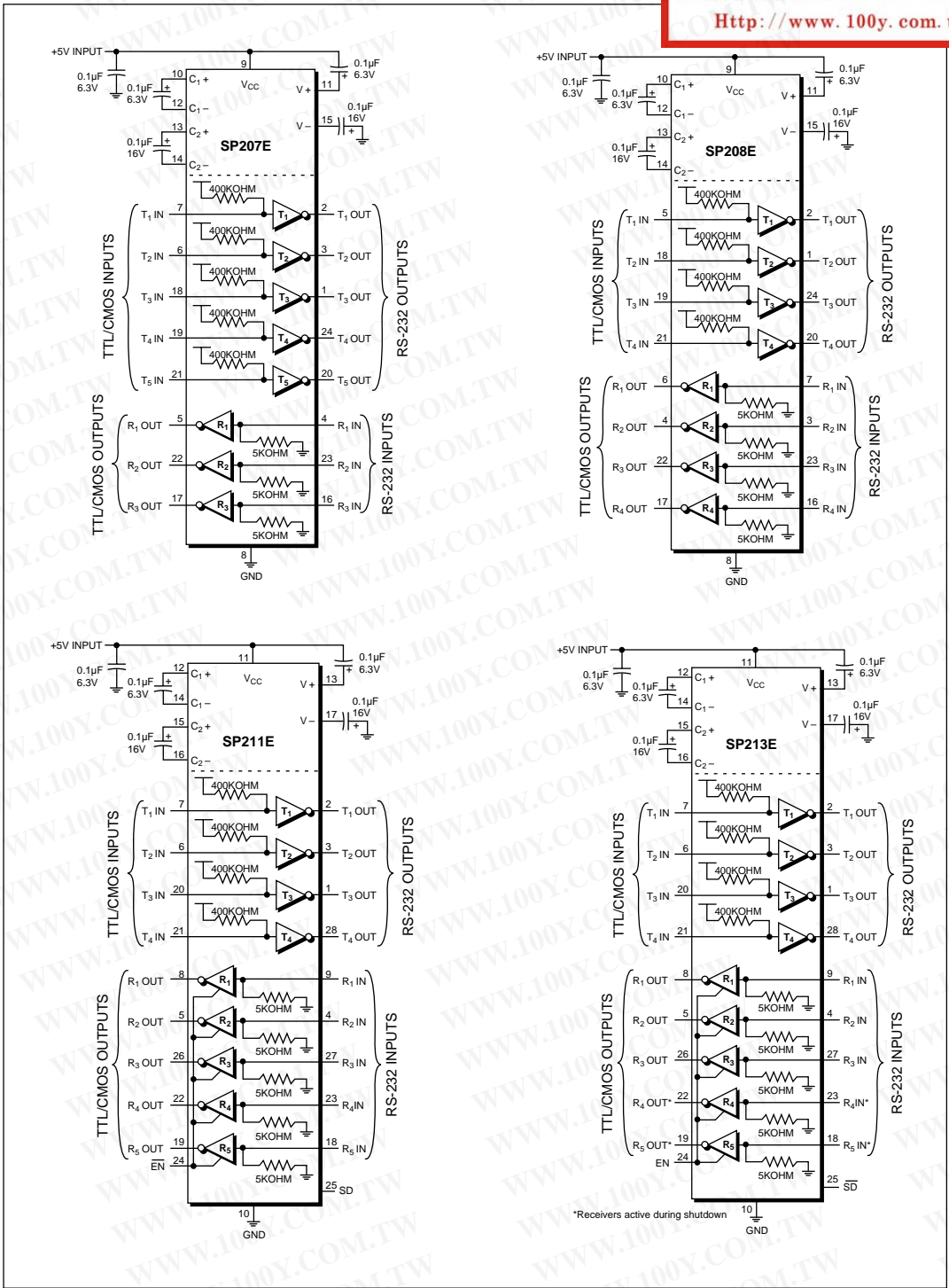

**PACKAGE: PLASTIC SHRINK
SMALL OUTLINE
(SSOP)**

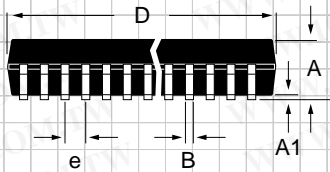
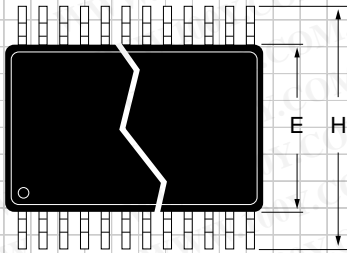

DIMENSIONS (Inches) Minimum/Maximum (mm)	24-PIN	28-PIN
A	0.068/0.078 (1.73/1.99)	0.068/0.078 (1.73/1.99)
A1	0.002/0.008 (0.05/0.21)	0.002/0.008 (0.05/0.21)
B	0.010/0.015 (0.25/0.38)	0.010/0.015 (0.25/0.38)
D	0.317/0.328 (8.07/8.33)	0.397/0.407 (10.07/10.33)
E	0.205/0.212 (5.20/5.38)	0.205/0.212 (5.20/5.38)
e	0.0256 BSC (0.65 BSC)	0.0256 BSC (0.65 BSC)
H	0.301/0.311 (7.65/7.90)	0.301/0.311 (7.65/7.90)
L	0.022/0.037 (0.55/0.95)	0.022/0.037 (0.55/0.95)
Ø	0°/8° (0°/8°)	0°/8° (0°/8°)

勝特力材料 886-3-5753170
 勝特力电子(上海) 86-21-34970699
 勝特力电子(深圳) 86-755-83298787
[Http://www.100y.com.tw](http://www.100y.com.tw)

**PACKAGE: PLASTIC
SMALL OUTLINE (SOIC)
(WIDE)**

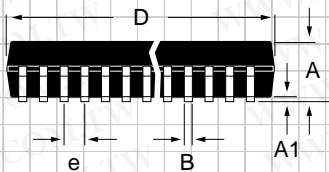
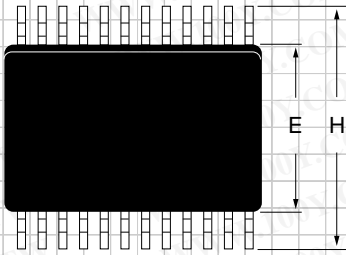

DIMENSIONS (Inches) Minimum/Maximum (mm)	24-PIN	28-PIN
A	0.093/0.104 (2.352/2.649)	0.093/0.104 (2.352/2.649)
A1	0.004/0.012 (0.102/0.300)	0.004/0.012 (0.102/0.300)
B	0.013/0.020 (0.330/0.508)	0.013/0.020 (0.330/0.508)
D	0.599/0.614 (15.20/15.59)	0.697/0.713 (17.70/18.09)
E	0.291/0.299 (7.402/7.600)	0.291/0.299 (7.402/7.600)
e	0.050 BSC (1.270 BSC)	0.050 BSC (1.270 BSC)
H	0.394/0.419 (10.00/10.64)	0.394/0.419 (10.00/10.64)
L	0.016/0.050 (0.406/1.270)	0.016/0.050 (0.406/1.270)
Ø	0°/8° (0°/8°)	0°/8° (0°/8°)

勝特力材料 886-3-5753170
 勝特力电子(上海) 86-21-34970699
 勝特力电子(深圳) 86-755-83298787
[Http://www.100y.com.tw](http://www.100y.com.tw)

PACKAGE: PLASTIC DUAL-IN-LINE (NARROW)

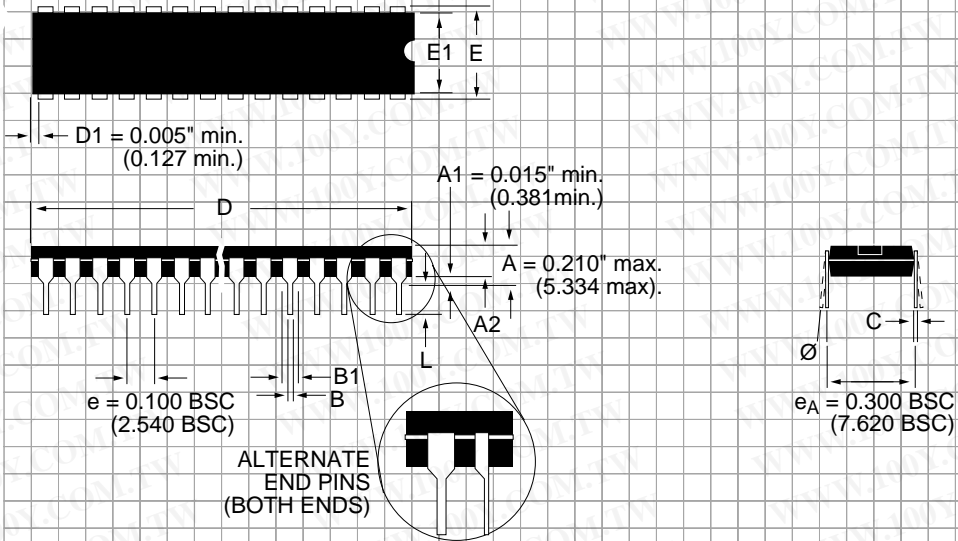

DIMENSIONS (Inches) Minimum/Maximum (mm)	24-PIN
A2	0.115/0.195 (2.921/4.953)
B	0.014/0.022 (0.356/0.559)
B1	0.045/0.070 (1.143/1.778)
C	0.008/0.014 (0.203/0.356)
D	1.230/1.280 (31.24/32.51)
E	0.300/0.325 (7.620/8.255)
E1	0.240/0.280 (6.096/7.112)
L	0.115/0.150 (2.921/3.810)
∅	0°/ 15° (0°/15°)

勝特力材料 886-3-5753170
 勝特力电子(上海) 86-21-34970699
 勝特力电子(深圳) 86-755-83298787
[Http://www.100y.com.tw](http://www.100y.com.tw)

ORDERING INFORMATION

RS232 Transceivers:

Model	Drivers	Receivers	Temperature Range	Package Type
SP207ECA	5	3	0°C to +70°C	24-pin SSOP
SP207ECP	5	3	0°C to +70°C	24-pin Plastic DIP
SP207ECT	5	3	0°C to +70°C	24-pin SOIC
SP207EEA	5	3	-40°C to +85°C	24-pin SSOP
SP207EEP	5	3	-40°C to +85°C	24-pin Plastic DIP
SP207EET	5	3	-40°C to +85°C	24-pin SOIC
SP208ECA	4	4	0°C to +70°C	24-pin SSOP
SP208ECP	4	4	0°C to +70°C	24-pin Plastic DIP
SP208ECT	4	4	0°C to +70°C	24-pin SOIC
SP208EEA	4	4	-40°C to +85°C	24-pin SSOP
SP208EEP	4	4	-40°C to +85°C	24-pin Plastic DIP
SP208EET	4	4	-40°C to +85°C	24-pin SOIC

RS232 Transceivers with Low-Power Shutdown and Tri-state Enable:

Model	Drivers	Receivers	Temperature Range	Package Type
SP211ECA	4	5	0°C to +70°C	28-pin SSOP
SP211ECT	4	5	0°C to +70°C	28-pin SOIC
SP211EEA	4	5	-40°C to +85°C	28-pin SSOP
SP211EET	4	5	-40°C to +85°C	28-pin SOIC

RS232 Transceivers with Low-Power Shutdown, Tri-state Enable, and Wake-Up Function:

Model	Drivers	Receivers	Temperature Range	Package Type
SP213ECA	4	5, with 2 active in Shutdown	0°C to +70°C	28-pin SSOP
SP213ECT	4	5, with 2 active in Shutdown	0°C to +70°C	28-pin SOIC
SP213EEA	4	5, with 2 active in Shutdown	-40°C to +85°C	28-pin SSOP
SP213EET	4	5, with 2 active in Shutdown	-40°C to +85°C	28-pin SOIC

Please consult the factory for pricing and availability on a Tape-On-Reel option.



SIGNAL PROCESSING EXCELLENCE

Sipex Corporation

Headquarters and Sales Office
 22 Linnell Circle
 Billerica, MA 01821
 TEL: (978) 667-8700
 FAX: (978) 670-9001
 e-mail: sales@sipex.com

Sales Office
 233 South Hillview Drive
 Milpitas, CA 95035
 TEL: (408) 934-7500
 FAX: (408) 935-7600

勝特力材料 886-3-5753170
 勝特力电子(上海) 86-21-34970699
 勝特力电子(深圳) 86-755-83298787
[Http://www.100y.com.tw](http://www.100y.com.tw)

Sipex Corporation reserves the right to make changes to any products described herein. Sipex does not assume any liability arising out of the application or use of any product or circuit described hereing; neither does it convey any license under its patent rights nor the rights of others.