

TOSHIBA BIPOLAR DIGITAL INTEGRATED CIRCUIT SILICON MONOLITHIC

**TD62786AP, TD62786F, TD62786AF
TD62787AP, TD62787F, TD62787AF**

8CH HIGH-VOLTAGE SOURCE DRIVER

The TD62786AP/F/AF series are eight channel huxy non-inverting source current transistor array. All units feature integral clamp diodes for switching inductive loads. Applications include relay, hammer and lamp drivers.

FEATURES

- High output voltage type-AP, AF : $V_{CE(SUS)} = 50V$ (Min.)
type-F : $V_{CE(SUS)} = 35V$ (Min.)
- Output current (single output) : $I_{OUT} = -500mA / ch$ (Max.)
- Output clamp diodes
- Single supply voltage
- Input compatible with TTL, 5V CMOS
- Low level active input
- Package type-AP : DIP-18 pin
- Package type-F, AF : SOP-18 pin

PIN CONNECTION (TOP VIEW)

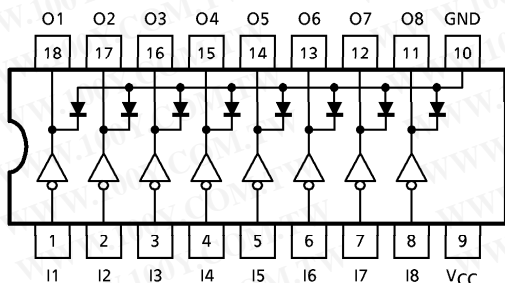

SCHEMATICS (EACH DRIVER)

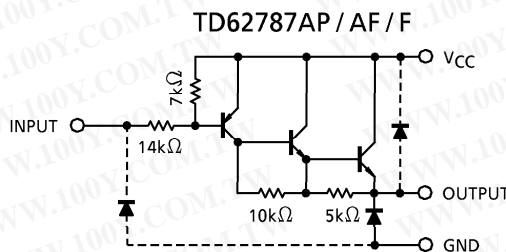
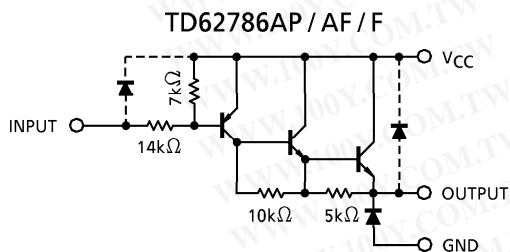

(Note) The input and output parasitic diodes cannot be used as clamp diodes.

勝特力材料 886-3-5753170
 勝特力电子(上海) 86-21-34970699
 勝特力电子(深圳) 86-755-83298787
 Http://www.100y.com.tw

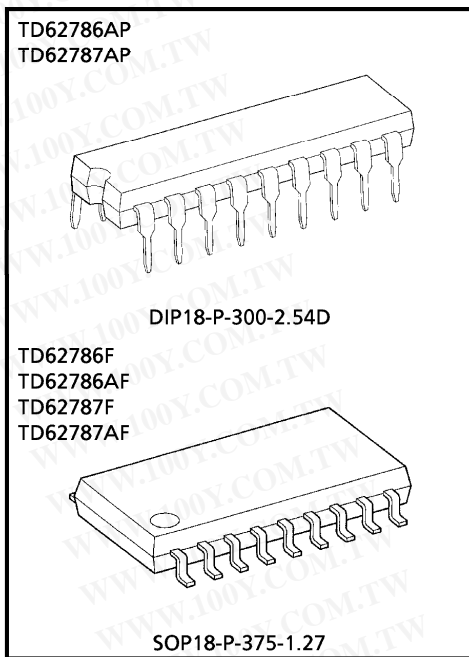

Weight
 DIP18-P-300-2.54D : 1.47g (Typ.)
 SOP18-P-375-1.27 : 0.41g (Typ.)

961001EBA2

● TOSHIBA is continually working to improve the quality and the reliability of its products. Nevertheless, semiconductor devices in general can malfunction or fail due to their inherent electrical sensitivity and vulnerability to physical stress. It is the responsibility of the buyer, when utilizing TOSHIBA products, to observe standards of safety, and to avoid situations in which a malfunction or failure of a TOSHIBA product could cause loss of human life, bodily injury or damage to property. In developing your designs, please ensure that TOSHIBA products are used within specified operating ranges as set forth in the most recent products specifications. Also, please keep in mind the precautions and conditions set forth in the TOSHIBA Semiconductor Reliability Handbook.

MAXIMUM RATINGS (Ta = 25°C)

CHARACTERISTIC		SYMBOL	RATING	UNIT
Supply Voltage	AP / AF	V _{CC} - V _{GND}	50	V
	F		35	
Output Sustaining Voltage	AP / AF	V _{OUT}	- 50	V
	F		- 35	
Output Current		I _{OUT}	- 500	mA / ch
Input Voltage		V _{IN} (Note 1)	- 30~0.5	V
Input Voltage		V _{IN} (Note 2)	V _{GND} ~7	V
Clamp Diode Forward Current	AP / AF	V _R	50	V
	F		35	
Clamp Diode Forward Current		I _F	500	mA
Power Dissipation	AP	P _D (Note 3)	1.47	W
	F / AF		0.96	
Operating Temperature		T _{opr}	- 40~85	°C
Storage Temperature		T _{stg}	- 55~150	°C

(Note 1) Only TD62786AP / F / AF

(Note 2) Only TD62787AP / F / AF

(Note 3) Delated above 25°C in the proportion of 11.7mW/°C (AP Type), 7.7mW/°C (F, AF Type).

RECOMMENDED OPERATING CONDITIONS (Ta = - 40~85°C, V_{CC} = 0V)

CHARACTERISTIC		SYMBOL	CONDITION	MIN.	TYP.	MAX.	UNIT
Supply Voltage	AP / AF	V _{CC} - V _{GND}	—	—	—	50	V
	F		—	—	—	35	
Output Voltage	AP / AF	V _{OUT}	—	—	—	- 50	V
	F		—	—	—	- 35	
Output Current		I _{OUT}	—	—	—	- 350	mA / ch
Input Voltage	TD62786	V _{IN}	—	- 30	—	0	V
	TD62787		—	V _{GND}	—	7	
Clamp Diode Reverse Voltage	AP / AF	V _R	—	—	—	50	V
	F		—	—	—	35	
Clamp Diode Forward Current		I _F	—	—	—	350	mA
Power Dissipation	AP	P _D	—	—	—	0.52	W
	AF / F		—	—	—	0.35	

961001EBA2'

- The products described in this document are subject to foreign exchange and foreign trade control laws.
- The information contained herein is presented only as a guide for the applications of our products. No responsibility is assumed by TOSHIBA CORPORATION for any infringements of intellectual property or other rights of the third parties which may result from its use. No license is granted by implication or otherwise under any intellectual property or other rights of TOSHIBA CORPORATION or others.
- The information contained herein is subject to change without notice.

ELECTRICAL CHARACTERISTICS (Ta = 25°C, VCC = 0V)

CHARACTERISTIC		SYMBOL	TEST CIR-CUIT	TEST CONDITION	MIN.	TYP.	MAX.	UNIT
Output Leakage Current		ICEX	1	VOUT = VGND = -50V Ta = 85°C	—	—	-100	μA
Output Saturation Voltage		VCE (sat)	2	VIN = VIL MAX. IOUT = -100mA	—	—	-1.8	V
				VIN = VIL MAX. IOUT = -350mA	—	—	-2.0	
DC Current transfer Ratio		hFE	2	VCC = 0V, VCE = 3V IOUT = -350mA	1000	—	—	—
Input Voltage	"H" Level	TD62786	VIN	—	-1.2	—	0	V
		TD62787			-1.6	—	5.5	
	"L" Level	TD62786			-30	—	-2.8	
		TD62787			VGND	—	-3.7	
Input Current		IIL	—	VCC = 5.5V, VIN = 0.4V	—	—	-0.4	mA
Clamp Diode Reverse Current		IR	—	VR = VR MAX., Ta = 85°C	—	—	100	μA
Clamp Diode Forward Voltage		VF	—	—	—	—	2.0	V
Turn-On Delay		tON	5	VOUT = -50V, RL = 163Ω CL = 15pF (Note)	—	0.2	—	μs
Turn Off Delay		tOFF			—	1.0	—	

(Note) VOUT = -35V, RL = 116Ω for Type-F

TEST CIRCUIT

1. I_{CEX}

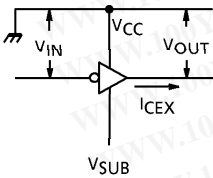

2. $V_{CE(sat)}$, h_{FE}

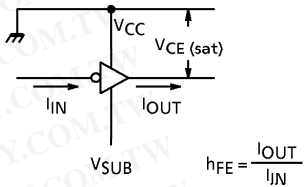

3. $I_{IN(ON)}$, $I_{IN(OFF)}$

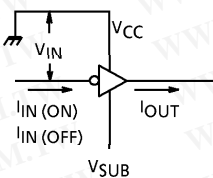

4. $V_{IN(ON)}$, $V_{IN(OFF)}$

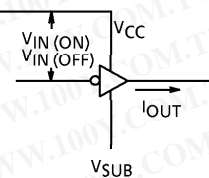

5. t_{ON} , t_{OFF}

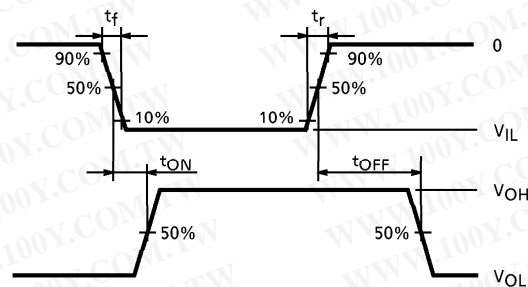
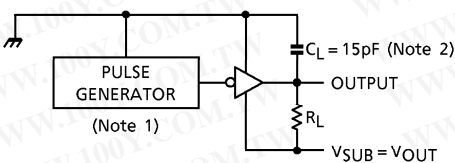

- (Note 1) Pulse Width $50\mu s$, Duty Cycle 10%
Output Impedance 50Ω , $t_r \leq 10ns$, $t_f \leq 5ns$
- (Note 2) C_L includes probe and jig capacitance.

PRECAUTIONS for USING

Utmost care is necessary in the design of the output line, V_{CC} and GND line since IC may be destroyed due to short-circuit between outputs, air contamination fault, or fault by improper grounding.

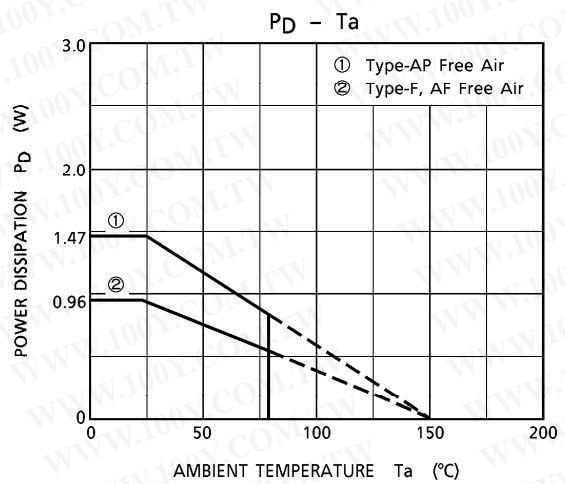
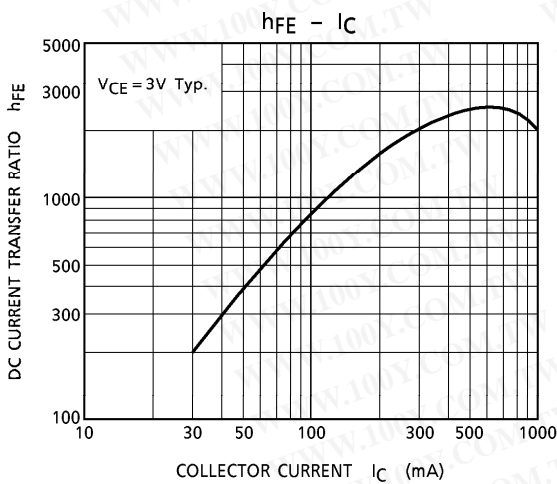
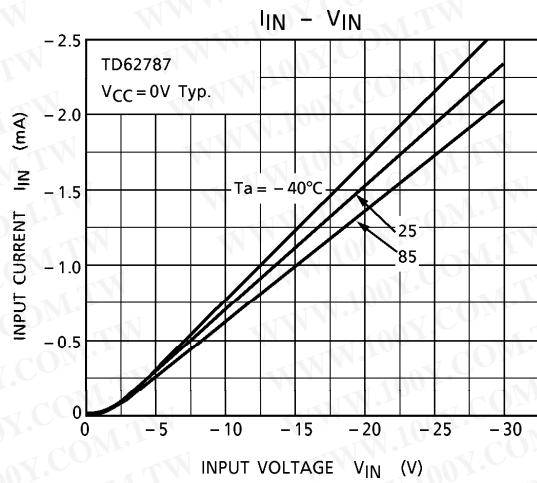
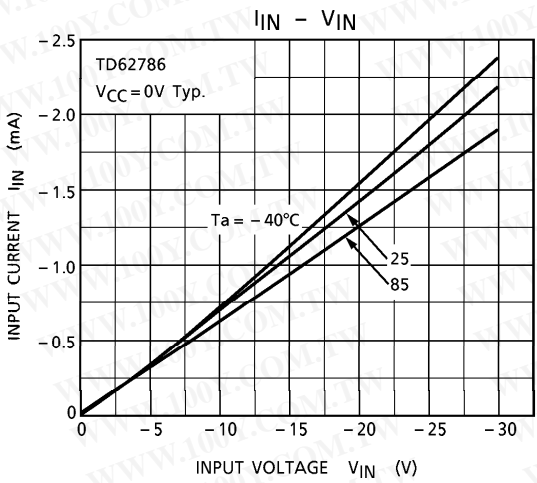
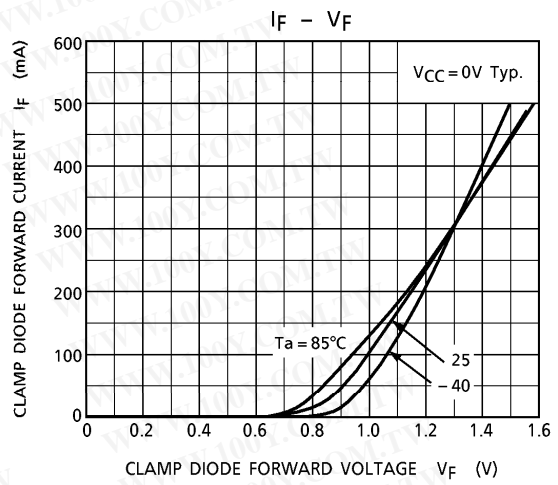
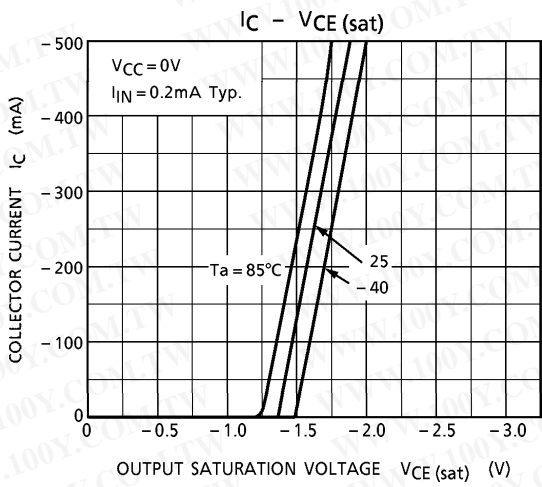

OUTLINE DRAWING
DIP18-P-300-2.54D

Unit : mm

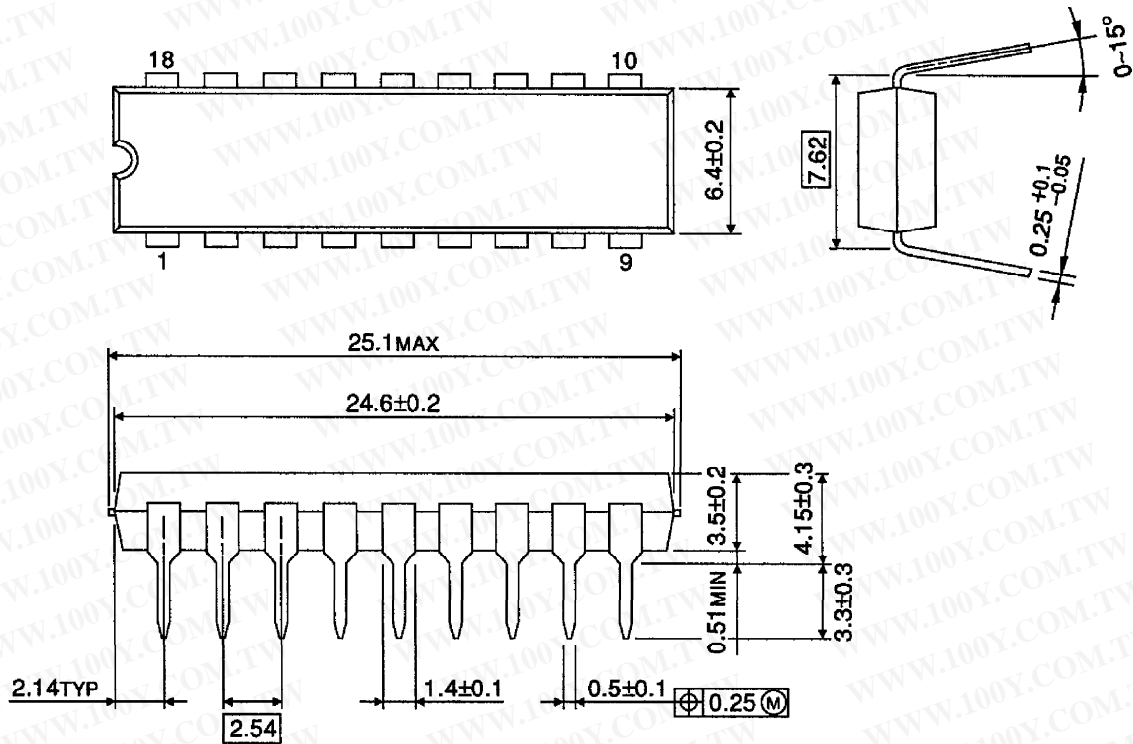

Weight : 1.47g (Typ.)

OUTLINE DRAWING
SOP18-P-375-1.27

Unit : mm

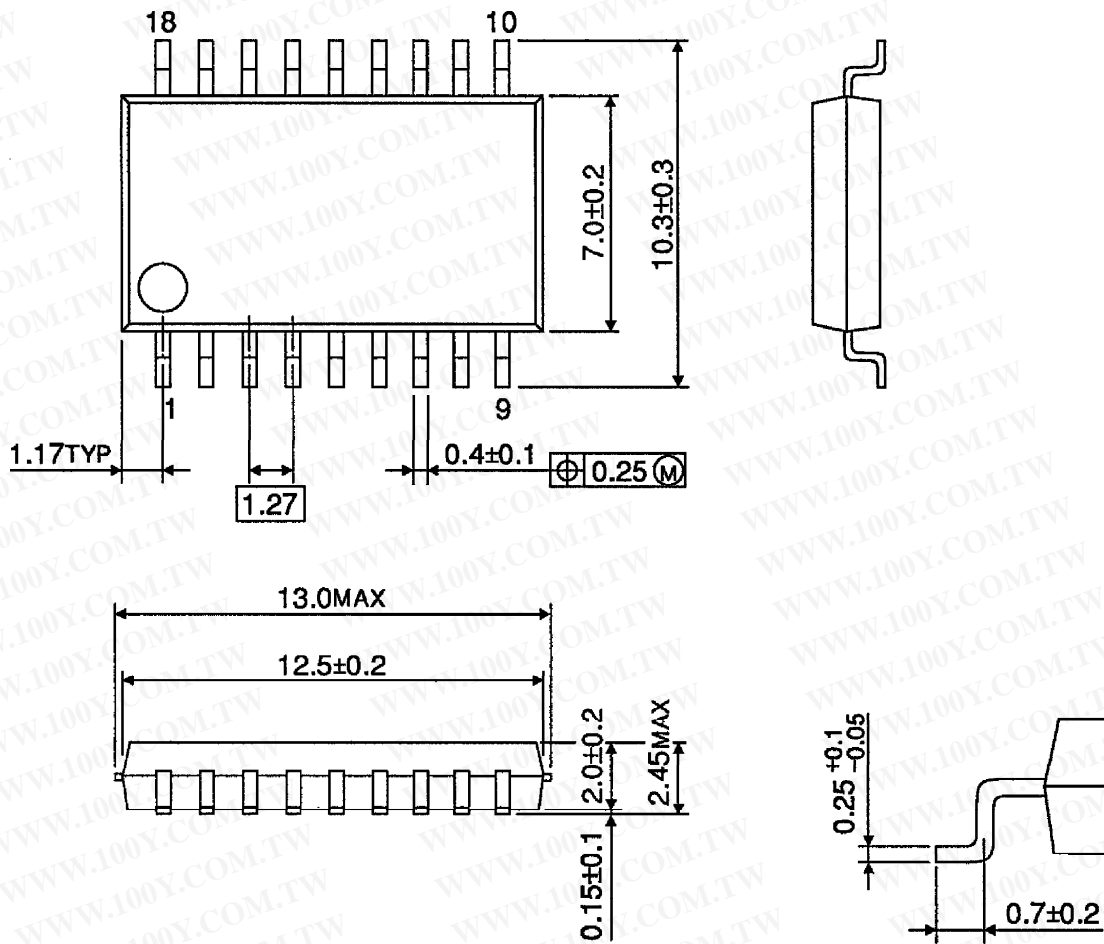

Weight : 0.41g (Typ.)

勝特力材料 886-3-5753170
 勝特力电子(上海) 86-21-34970699
 勝特力电子(深圳) 86-755-83298787
[Http://www.100y.com.tw](http://www.100y.com.tw)