



Ultralow Noise, LDO XFET Voltage References with Current Sink and Source

ADR440/ADR441/ADR443/ADR444/ADR445

FEATURES

Ultralow noise (0.1 Hz to 10 Hz)

- ADR440: 1 $\mu\text{V p-p}$
- ADR441: 1.2 $\mu\text{V p-p}$
- ADR443: 1.4 $\mu\text{V p-p}$
- ADR444: 1.8 $\mu\text{V p-p}$
- ADR445: 2.25 $\mu\text{V p-p}$

Superb temperature coefficient

- A grade: 10 ppm/°C
- B grade: 3 ppm/°C

Low dropout operation: 500 mV

Input range: ($V_{\text{OUT}} + 500 \text{ mV}$) to 18 V

High output source and sink current
+10 mA and -5 mA, respectively

Wide temperature range: -40°C to +125°C

APPLICATIONS

- Precision data acquisition systems
- High resolution data converters
- Battery-powered instrumentation
- Portable medical instruments
- Industrial process control systems
- Precision instruments
- Optical control circuits

GENERAL DESCRIPTION

The ADR44x series is a family of XFET® voltage references featuring ultralow noise, high accuracy, and low temperature drift performance. Using Analog Devices, Inc., patented temperature drift curvature correction and XFET (eXtra implanted junction FET) technology, voltage change vs. temperature nonlinearity in the ADR44x is greatly minimized.

The XFET references offer better noise performance than buried Zener references, and XFET references operate off low supply voltage headroom (0.5 V). This combination of features makes the ADR44x family ideally suited for precision signal conversion applications in high-end data acquisition systems, optical networks, and medical applications.

The ADR44x family has the capability to source up to 10 mA of output current and sink up to -5 mA. It also comes with a trim terminal to adjust the output voltage over a 0.5% range without compromising performance.

勝特力材料 886-3-5753170
 勝特力电子(上海) 86-21-34970699
 勝特力电子(深圳) 86-755-83298787
[Http://www.100y.com.tw](http://www.100y.com.tw)

PIN CONFIGURATIONS

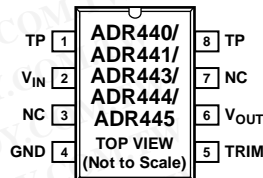

- NOTES
 1. NC = NO CONNECT
 2. TP = TEST PIN (DO NOT CONNECT)

Figure 1. 8-Lead SOIC_N (R-Suffix)

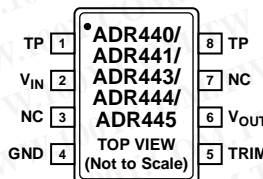

- NOTES
 1. NC = NO CONNECT
 2. TP = TEST PIN (DO NOT CONNECT)

Figure 2. 8-Lead MSOP (RM-Suffix)

Offered in two electrical grades, the ADR44x family is available in 8-lead MSOP and narrow SOIC packages. All versions are specified over the extended industrial temperature range of -40°C to +125°C.

Table 1. Selection Guide

Model	Output Voltage (V)	Initial Accuracy (mV)	Temperature Coefficient (ppm/°C)
ADR440A	2.048	±3	10
ADR440B	2.048	±1	3
ADR441A	2.500	±3	10
ADR441B	2.500	±1	3
ADR443A	3.000	±4	10
ADR443B	3.000	±1.2	3
ADR444A	4.096	±5	10
ADR444B	4.096	±1.6	3
ADR445A	5.000	±6	10
ADR445B	5.000	±2	3

Rev. E

Information furnished by Analog Devices is believed to be accurate and reliable. However, no responsibility is assumed by Analog Devices for its use, nor for any infringements of patents or other rights of third parties that may result from its use. Specifications subject to change without notice. No license is granted by implication or otherwise under any patent or patent rights of Analog Devices. Trademarks and registered trademarks are the property of their respective owners.

ADR440/ADR441/ADR443/ADR444/ADR445

TABLE OF CONTENTS

Features	1	Theory of Operation	14
Applications	1	Power Dissipation Considerations	14
Pin Configurations	1	Basic Voltage Reference Connections	14
General Description	1	Noise Performance	14
Revision History	2	Turn-On Time	14
Specifications	3	Applications Information	15
ADR440 Electrical Characteristics	3	Output Adjustment	15
ADR441 Electrical Characteristics	4	Bipolar Outputs	15
ADR443 Electrical Characteristics	5	Programmable Voltage Source	15
ADR444 Electrical Characteristics	6	Programmable Current Source	16
ADR445 Electrical Characteristics	7	High Voltage Floating Current Source	16
Absolute Maximum Ratings	8	Precision Output Regulator (Boosted Reference)	16
Thermal Resistance	8	Outline Dimensions	17
ESD Caution	8	Ordering Guide	18
Typical Performance Characteristics	9		

REVISION HISTORY

11/10—Rev. D to Rev. E

Deleted Negative Reference Section	15
Deleted Figure 37; Renumbered Sequentially	15

3/10—Rev. C to Rev. D

Changes to Figure 37	15
Updated Outline Dimensions	18

3/08—Rev. B to Rev. C

Changes to Table 8	8
Change to Figure 11	10
Changes to Figure 36	15
Changes to Figure 39	16
Changes to Figure 41	17
Updated Outline Dimensions	18

8/07—Rev. A to Rev. B

Change to Table 2, Ripple Rejection Ratio Specification	3
Change to Table 3, Ripple Rejection Ratio Specification	4
Change to Table 4, Ripple Rejection Ratio Specification	5
Change to Table 5, Ripple Rejection Ratio Specification	6
Change to Table 6, Ripple Rejection Ratio Specification	7

9/06—Rev. 0 to Rev. A

Updated Format	Universal
Changes to Features	1
Changes to Pin Configurations	1
Changes to Specifications Section	3
Changes to Figure 4 and Figure 5	9
Inserted Figure 6 and Figure 7	9
Changes to Figure 15	11
Changes to Power Dissipation Considerations Section	14
Changes to Figure 35 and Figure 36	15
Changes to Figure 38 and Table 9	16
Updated Outline Dimensions	18
Changes to Ordering Guide	19

10/05—Revision 0: Initial Version

SPECIFICATIONS

ADR440 ELECTRICAL CHARACTERISTICS

$V_{IN} = 3\text{ V to }18\text{ V}$, $T_A = 25^\circ\text{C}$, $C_{IN} = C_{OUT} = 0.1\ \mu\text{F}$, unless otherwise noted.

Table 2.

Parameter	Symbol	Conditions	Min	Typ	Max	Unit
OUTPUT VOLTAGE	V_O					
A Grade			2.045	2.048	2.051	V
B Grade			2.047	2.048	2.049	V
INITIAL ACCURACY	V_{OERR}					
A Grade					3	mV
					0.15	%
B Grade					1	mV
					0.05	%
TEMPERATURE DRIFT	TCV_O					
A Grade		$-40^\circ\text{C} < T_A < +125^\circ\text{C}$		2	10	ppm/ $^\circ\text{C}$
B Grade		$-40^\circ\text{C} < T_A < +125^\circ\text{C}$		1	3	ppm/ $^\circ\text{C}$
LINE REGULATION	$\Delta V_O/\Delta V_{IN}$	$-40^\circ\text{C} < T_A < +125^\circ\text{C}$	-20	+10	+20	ppm/V
LOAD REGULATION	$\Delta V_O/\Delta I_{LOAD}$	$I_{LOAD} = 0\text{ mA to }10\text{ mA}$, $V_{IN} = 3.5\text{ V}$, $-40^\circ\text{C} < T_A < +125^\circ\text{C}$	-50		+50	ppm/mA
	$\Delta V_O/\Delta I_{LOAD}$	$I_{LOAD} = 0\text{ mA to }-5\text{ mA}$, $V_{IN} = 3.5\text{ V}$, $-40^\circ\text{C} < T_A < +125^\circ\text{C}$	-50		+50	ppm/mA
QUIESCENT CURRENT	I_{IN}	No load, $-40^\circ\text{C} < T_A < +125^\circ\text{C}$		3	3.75	mA
VOLTAGE NOISE	$e_n\text{ p-p}$	0.1 Hz to 10 Hz		1		$\mu\text{V p-p}$
VOLTAGE NOISE DENSITY	e_n	1 kHz		45		nV/ $\sqrt{\text{Hz}}$
TURN-ON SETTLING TIME	t_R			10		μs
LONG-TERM STABILITY ¹	V_O	1000 hours		50		ppm
OUTPUT VOLTAGE HYSTERESIS	V_{O_HYS}			70		ppm
RIPPLE REJECTION RATIO	RRR	$f_{IN} = 1\text{ kHz}$		-80		dB
SHORT CIRCUIT TO GND	I_{SC}			27		mA
SUPPLY VOLTAGE OPERATING RANGE	V_{IN}		3		18	V
SUPPLY VOLTAGE HEADROOM	$V_{IN} - V_O$		500			mV

¹ The long-term stability specification is noncumulative. The drift in the subsequent 1000-hour period is significantly lower than in the first 1000-hour period.

ADR440/ADR441/ADR443/ADR444/ADR445

ADR441 ELECTRICAL CHARACTERISTICS

$V_{IN} = 3\text{ V to }18\text{ V}$, $T_A = 25^\circ\text{C}$, $C_{IN} = C_{OUT} = 0.1\ \mu\text{F}$, unless otherwise noted.

Table 3.

Parameter	Symbol	Conditions	Min	Typ	Max	Unit
OUTPUT VOLTAGE	V_O					
A Grade			2.497	2.500	2.503	V
B Grade			2.499	2.500	2.501	V
INITIAL ACCURACY	V_{OERR}					
A Grade					3	mV
B Grade					0.12	%
					1	mV
					0.04	%
TEMPERATURE DRIFT	TCV_O					
A Grade		$-40^\circ\text{C} < T_A < +125^\circ\text{C}$		2	10	ppm/ $^\circ\text{C}$
B Grade		$-40^\circ\text{C} < T_A < +125^\circ\text{C}$		1	3	ppm/ $^\circ\text{C}$
LINE REGULATION	$\Delta V_O/\Delta V_{IN}$	$-40^\circ\text{C} < T_A < +125^\circ\text{C}$		10	20	ppm/V
LOAD REGULATION	$\Delta V_O/\Delta I_{LOAD}$	$I_{LOAD} = 0\text{ mA to }10\text{ mA}$, $V_{IN} = 4\text{ V}$, $-40^\circ\text{C} < T_A < +125^\circ\text{C}$	-50		+50	ppm/mA
	$\Delta V_O/\Delta I_{LOAD}$	$I_{LOAD} = 0\text{ mA to }-5\text{ mA}$, $V_{IN} = 4\text{ V}$, $-40^\circ\text{C} < T_A < +125^\circ\text{C}$	-50		+50	ppm/mA
QUIESCENT CURRENT	I_{IN}	No load, $-40^\circ\text{C} < T_A < +125^\circ\text{C}$		3	3.75	mA
VOLTAGE NOISE	$e_n\text{ p-p}$	0.1 Hz to 10 Hz		1.2		$\mu\text{V p-p}$
VOLTAGE NOISE DENSITY	e_n	1 kHz		48		nV/ $\sqrt{\text{Hz}}$
TURN-ON SETTLING TIME	t_R			10		μs
LONG-TERM STABILITY ¹	V_O	1000 hours		50		ppm
OUTPUT VOLTAGE HYSTERESIS	V_{O_HYS}			70		ppm
RIPPLE REJECTION RATIO	RRR	$f_{IN} = 1\text{ kHz}$		-80		dB
SHORT CIRCUIT TO GND	I_{SC}			27		mA
SUPPLY VOLTAGE OPERATING RANGE	V_{IN}		3		18	V
SUPPLY VOLTAGE HEADROOM	$V_{IN} - V_O$		500			mV

¹ The long-term stability specification is noncumulative. The drift in subsequent 1000-hour period is significantly lower than in the first 1000-hour period.

ADR440/ADR441/ADR443/ADR444/ADR445

ADR443 ELECTRICAL CHARACTERISTICS

$V_{IN} = 3.5\text{ V to }18\text{ V}$, $T_A = 25^\circ\text{C}$, $C_{IN} = C_{OUT} = 0.1\ \mu\text{F}$, unless otherwise noted.

Table 4.

Parameter	Symbol	Conditions	Min	Typ	Max	Unit
OUTPUT VOLTAGE	V_O					
A Grade			2.996	3.000	3.004	V
B Grade			2.9988	3.000	3.0012	V
INITIAL ACCURACY	V_{OERR}					
A Grade					4	mV
					0.13	%
B Grade					1.2	mV
					0.04	%
TEMPERATURE DRIFT	TCV_O					
A Grade		$-40^\circ\text{C} < T_A < +125^\circ\text{C}$		2	10	ppm/ $^\circ\text{C}$
B Grade		$-40^\circ\text{C} < T_A < +125^\circ\text{C}$		1	3	ppm/ $^\circ\text{C}$
LINE REGULATION	$\Delta V_O/\Delta V_{IN}$	$-40^\circ\text{C} < T_A < +125^\circ\text{C}$		10	20	ppm/V
LOAD REGULATION	$\Delta V_O/\Delta I_{LOAD}$	$I_{LOAD} = 0\text{ mA to }10\text{ mA}$, $V_{IN} = 5\text{ V}$, $-40^\circ\text{C} < T_A < +125^\circ\text{C}$	-50		+50	ppm/mA
	$\Delta V_O/\Delta I_{LOAD}$	$I_{LOAD} = 0\text{ mA to }-5\text{ mA}$, $V_{IN} = 5\text{ V}$, $-40^\circ\text{C} < T_A < +125^\circ\text{C}$	-50		+50	ppm/mA
QUIESCENT CURRENT	I_{IN}	No load, $-40^\circ\text{C} < T_A < +125^\circ\text{C}$		3	3.75	mA
VOLTAGE NOISE	$e_N\text{ p-p}$	0.1 Hz to 10 Hz		1.4		$\mu\text{V p-p}$
VOLTAGE NOISE DENSITY	e_N	1 kHz		57.6		nV/ $\sqrt{\text{Hz}}$
TURN-ON SETTLING TIME	t_R			10		μs
LONG-TERM STABILITY ¹	V_O	1000 hours		50		ppm
OUTPUT VOLTAGE HYSTERESIS	V_{O_HYS}			70		ppm
RIPPLE REJECTION RATIO	RRR	$f_{IN} = 1\text{ kHz}$		-80		dB
SHORT CIRCUIT TO GND	I_{SC}			27		mA
SUPPLY VOLTAGE OPERATING RANGE	V_{IN}		3.5		18	V
SUPPLY VOLTAGE HEADROOM	$V_{IN} - V_O$		500			mV

¹ The long-term stability specification is noncumulative. The drift in the subsequent 1000-hour period is significantly lower than in the first 1000-hour period.

ADR440/ADR441/ADR443/ADR444/ADR445

ADR444 ELECTRICAL CHARACTERISTICS

$V_{IN} = 4.6 \text{ V}$ to 18 V , $T_A = 25^\circ\text{C}$, $C_{IN} = C_{OUT} = 0.1 \mu\text{F}$, unless otherwise noted.

Table 5.

Parameter	Symbol	Conditions	Min	Typ	Max	Unit
OUTPUT VOLTAGE	V_O					
A Grade			4.091	4.096	4.101	V
B Grade			4.0944	4.096	4.0976	V
INITIAL ACCURACY	V_{OERR}					
A Grade					5	mV
B Grade					0.13	%
					1.6	mV
					0.04	%
TEMPERATURE DRIFT	TCV_O					
A Grade		$-40^\circ\text{C} < T_A < +125^\circ\text{C}$		2	10	ppm/ $^\circ\text{C}$
B Grade		$-40^\circ\text{C} < T_A < +125^\circ\text{C}$		1	3	ppm/ $^\circ\text{C}$
LINE REGULATION	$\Delta V_O/\Delta V_{IN}$	$-40^\circ\text{C} < T_A < +125^\circ\text{C}$		10	20	ppm/V
LOAD REGULATION	$\Delta V_O/\Delta I_{LOAD}$	$I_{LOAD} = 0 \text{ mA to } 10 \text{ mA}$, $V_{IN} = 5.5 \text{ V}$, $-40^\circ\text{C} < T_A < +125^\circ\text{C}$	-50		+50	ppm/mA
	$\Delta V_O/\Delta I_{LOAD}$	$I_{LOAD} = 0 \text{ mA to } -5 \text{ mA}$, $V_{IN} = 5.5 \text{ V}$, $-40^\circ\text{C} < T_A < +125^\circ\text{C}$	-50		+50	ppm/mA
QUIESCENT CURRENT	I_{IN}	No load, $-40^\circ\text{C} < T_A < +125^\circ\text{C}$		3	3.75	mA
VOLTAGE NOISE	$e_N \text{ p-p}$	0.1 Hz to 10 Hz		1.8		$\mu\text{V p-p}$
VOLTAGE NOISE DENSITY	e_N	1 kHz		78.6		nV/ $\sqrt{\text{Hz}}$
TURN-ON SETTLING TIME	t_R			10		μs
LONG-TERM STABILITY ¹	V_O	1000 hours		50		ppm
OUTPUT VOLTAGE HYSTERESIS	V_{O_HYS}			70		ppm
RIPPLE REJECTION RATIO	RRR	$f_{IN} = 1 \text{ kHz}$		-80		dB
SHORT CIRCUIT TO GND	I_{SC}			27		mA
SUPPLY VOLTAGE OPERATING RANGE	V_{IN}		4.6		18	V
SUPPLY VOLTAGE HEADROOM	$V_{IN} - V_O$		500			mV

¹ The long-term stability specification is noncumulative. The drift in the subsequent 1000-hour period is significantly lower than in the first 1000-hour period.

ADR440/ADR441/ADR443/ADR444/ADR445

ADR445 ELECTRICAL CHARACTERISTICS

$V_{IN} = 5.5\text{ V to }18\text{ V}$, $T_A = 25^\circ\text{C}$, $C_{IN} = C_{OUT} = 0.1\ \mu\text{F}$, unless otherwise noted.

Table 6.

Parameter	Symbol	Conditions	Min	Typ	Max	Unit
OUTPUT VOLTAGE	V_O					
A Grade			4.994	5.000	5.006	V
B Grade			4.998	5.000	5.002	V
INITIAL ACCURACY	V_{OERR}					
A Grade					6	mV
					0.12	%
B Grade					2	mV
					0.04	%
TEMPERATURE DRIFT	TCV_O					
A Grade		$-40^\circ\text{C} < T_A < +125^\circ\text{C}$		2	10	ppm/ $^\circ\text{C}$
B Grade		$-40^\circ\text{C} < T_A < +125^\circ\text{C}$		1	3	ppm/ $^\circ\text{C}$
LINE REGULATION	$\Delta V_O/\Delta V_{IN}$	$-40^\circ\text{C} < T_A < +125^\circ\text{C}$		10	20	ppm/V
LOAD REGULATION	$\Delta V_O/\Delta I_{LOAD}$	$I_{LOAD} = 0\text{ mA to }10\text{ mA}$, $V_{IN} = 6.5\text{ V}$, $-40^\circ\text{C} < T_A < +125^\circ\text{C}$	-50		+50	ppm/mA
	$\Delta V_O/\Delta I_{LOAD}$	$I_{LOAD} = 0\text{ mA to }-5\text{ mA}$, $V_{IN} = 6.5\text{ V}$, $-40^\circ\text{C} < T_A < +125^\circ\text{C}$	-50		+50	ppm/mA
QUIESCENT CURRENT	I_{IN}	No load, $-40^\circ\text{C} < T_A < +125^\circ\text{C}$		3	3.75	mA
VOLTAGE NOISE	$e_N\text{ p-p}$	0.1 Hz to 10 Hz		2.25		$\mu\text{V p-p}$
VOLTAGE NOISE DENSITY	e_N	1 kHz		90		nV/ $\sqrt{\text{Hz}}$
TURN-ON SETTLING TIME	t_R			10		μs
LONG-TERM STABILITY ¹	V_O	1000 hours		50		ppm
OUTPUT VOLTAGE HYSTERESIS	$V_{O,HYS}$			70		ppm
RIPPLE REJECTION RATIO	RRR	$f_{IN} = 1\text{ kHz}$		-80		dB
SHORT CIRCUIT TO GND	I_{SC}			27		mA
SUPPLY VOLTAGE OPERATING RANGE	V_{IN}		5.5		18	V
SUPPLY VOLTAGE HEADROOM	$V_{IN} - V_O$		500			mV

¹ The long-term stability specification is noncumulative. The drift in the subsequent 1000-hour period is significantly lower than in the first 1000-hour period.

ADR440/ADR441/ADR443/ADR444/ADR445

ABSOLUTE MAXIMUM RATINGS

T_A = 25°C, unless otherwise noted.

Table 7.

Parameter	Rating
Supply Voltage	20 V
Output Short-Circuit Duration to GND	Indefinite
Storage Temperature Range	-65°C to +125°C
Operating Temperature Range	-40°C to +125°C
Junction Temperature Range	-65°C to +150°C
Lead Temperature, Soldering (60 sec)	300°C

Stresses above those listed under Absolute Maximum Ratings may cause permanent damage to the device. This is a stress rating only; functional operation of the device at these or any other conditions above those indicated in the operational section of this specification is not implied. Exposure to absolute maximum rating conditions for extended periods may affect device reliability.

THERMAL RESISTANCE

θ_{JA} is specified for the worst-case conditions, that is, a device soldered in a circuit board for surface-mount packages.

Table 8. Thermal Resistance

Package Type	θ_{JA}	θ_{JC}	Unit
8-Lead SOIC (R-Suffix)	130	43	°C/W
8-Lead MSOP (RM-Suffix)	132.5	43.9	°C/W

ESD CAUTION



ESD (electrostatic discharge) sensitive device. Charged devices and circuit boards can discharge without detection. Although this product features patented or proprietary protection circuitry, damage may occur on devices subjected to high energy ESD. Therefore, proper ESD precautions should be taken to avoid performance degradation or loss of functionality.

TYPICAL PERFORMANCE CHARACTERISTICS

$V_{IN} = 7\text{ V}$, $T_A = 25^\circ\text{C}$, $C_{IN} = C_{OUT} = 0.1\ \mu\text{F}$, unless otherwise noted.

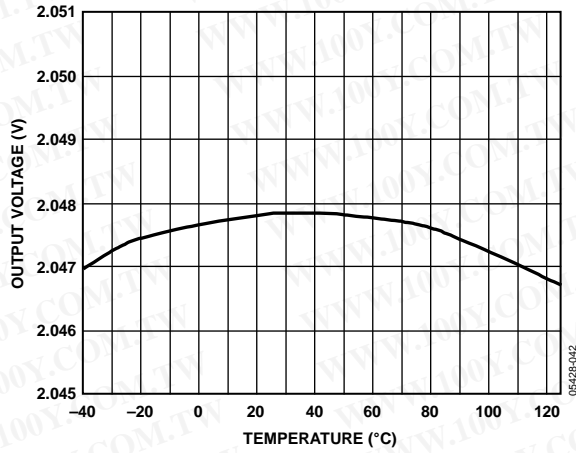

Figure 3. ADR440 Output Voltage vs. Temperature

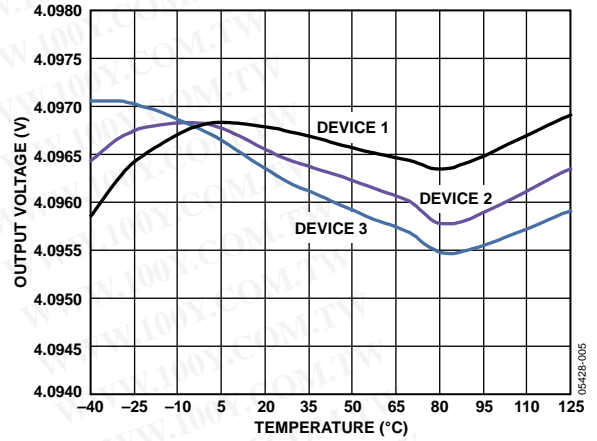

Figure 6. ADR444 Output Voltage vs. Temperature

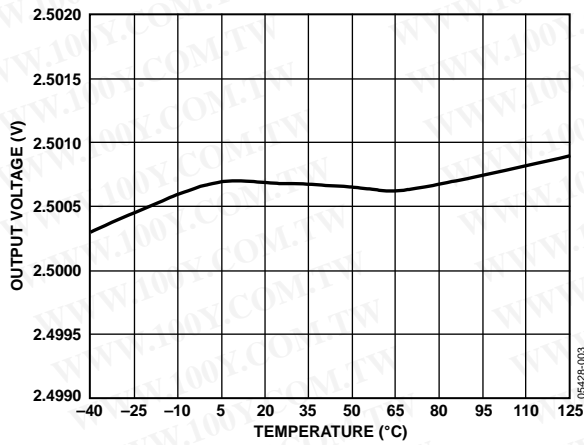

Figure 4. ADR441 Output Voltage vs. Temperature

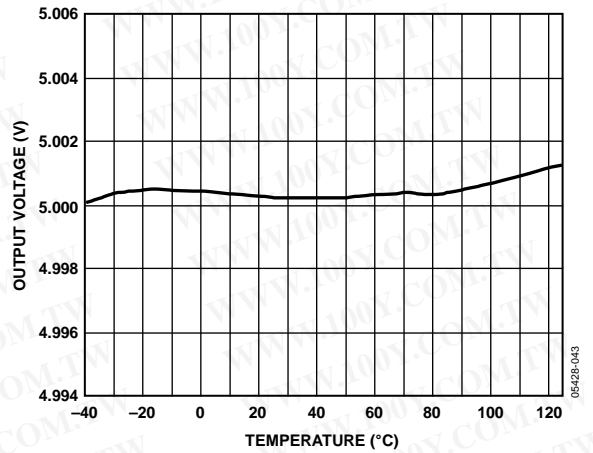

Figure 7. ADR445 Output Voltage vs. Temperature

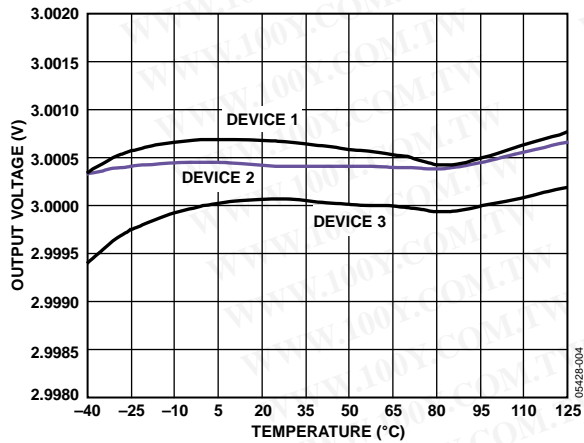

Figure 5. ADR443 Output Voltage vs. Temperature

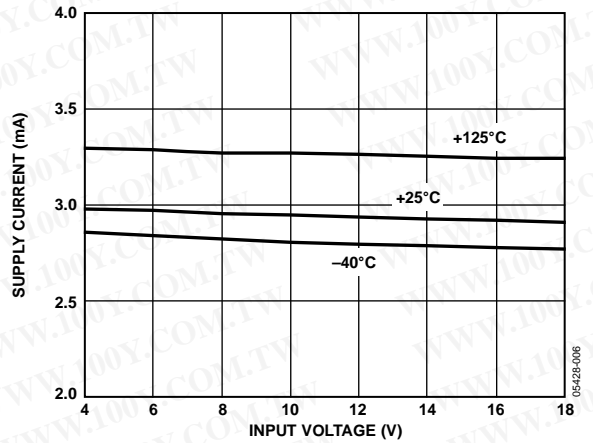

Figure 8. ADR441 Supply Current vs. Input Voltage

ADR440/ADR441/ADR443/ADR444/ADR445

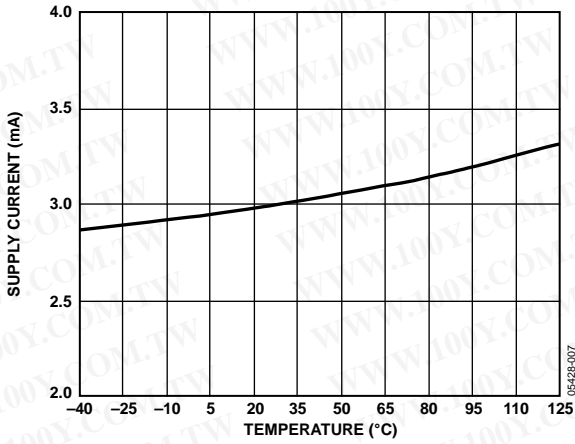

Figure 9. ADR441 Supply Current vs. Temperature

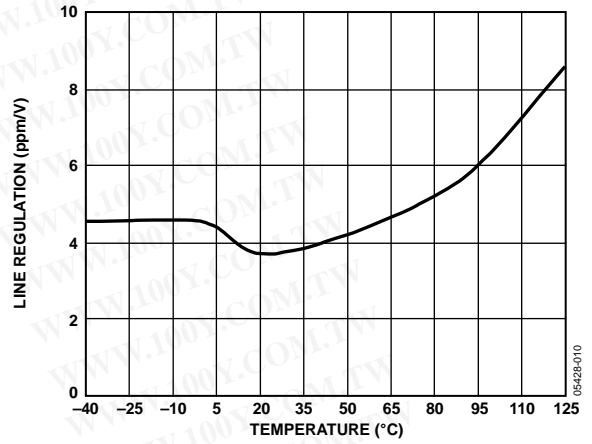

Figure 12. ADR441 Line Regulation vs. Temperature

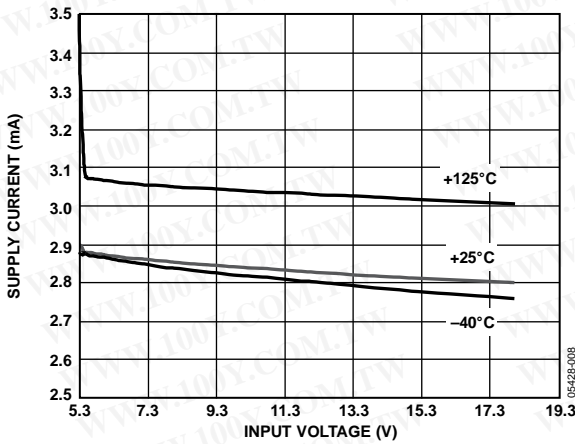

Figure 10. ADR445 Supply Current vs. Input Voltage

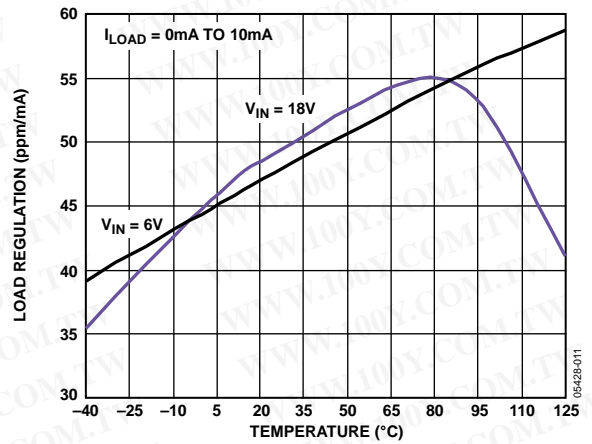

Figure 13. ADR441 Load Regulation vs. Temperature

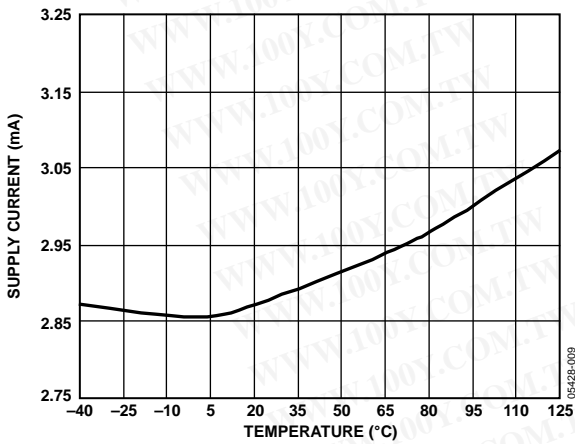

Figure 11. ADR445 Supply Current vs. Temperature

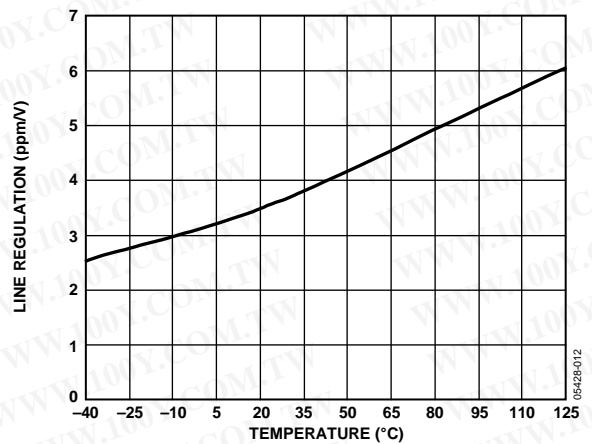

Figure 14. ADR445 Line Regulation vs. Temperature

ADR440/ADR441/ADR443/ADR444/ADR445

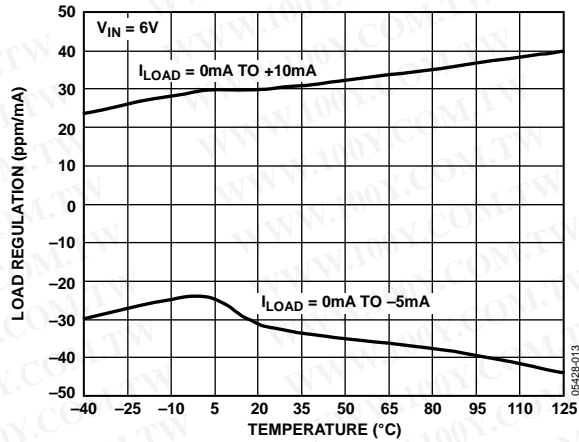

Figure 15. ADR445 Load Regulation vs. Temperature

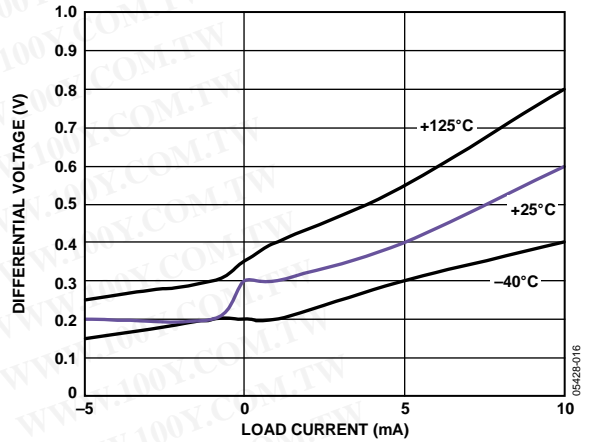

Figure 18. ADR445 Minimum Input/Output Differential Voltage vs. Load Current

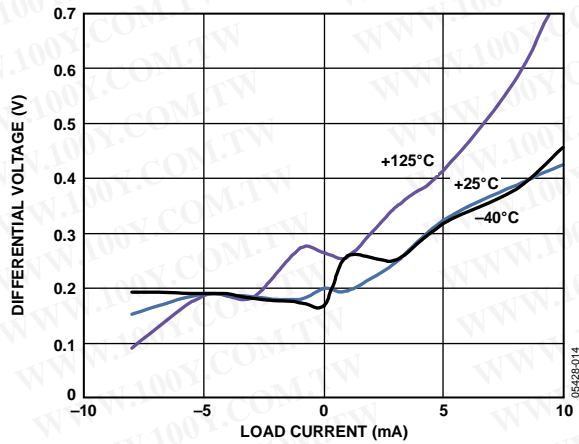

Figure 16. ADR441 Minimum Input/Output Differential Voltage vs. Load Current

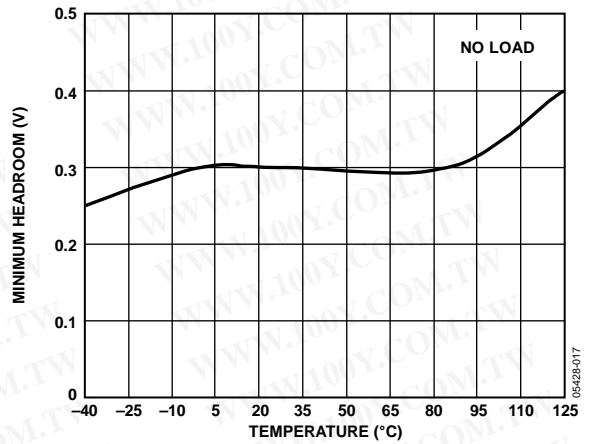

Figure 19. ADR445 Minimum Headroom vs. Temperature

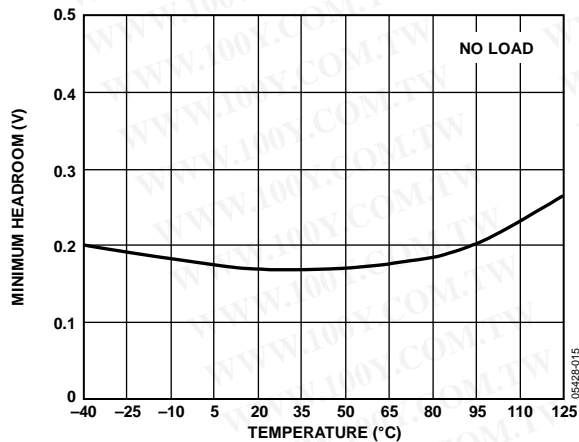

Figure 17. ADR441 Minimum Headroom vs. Temperature

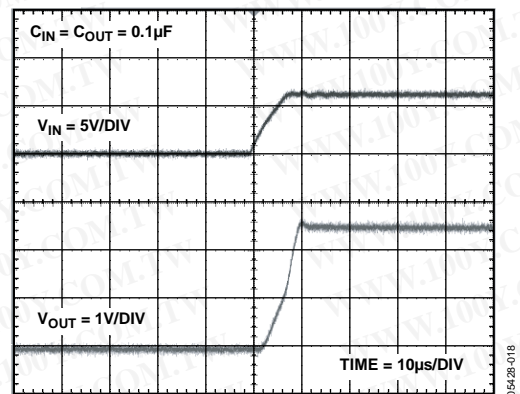

Figure 20. ADR441 Turn-On Response

ADR440/ADR441/ADR443/ADR444/ADR445

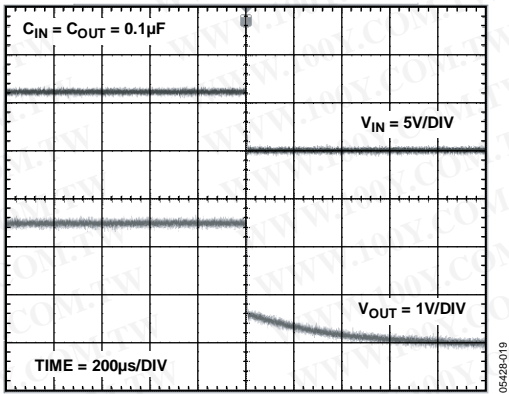

Figure 21. ADR441 Turn-Off Response

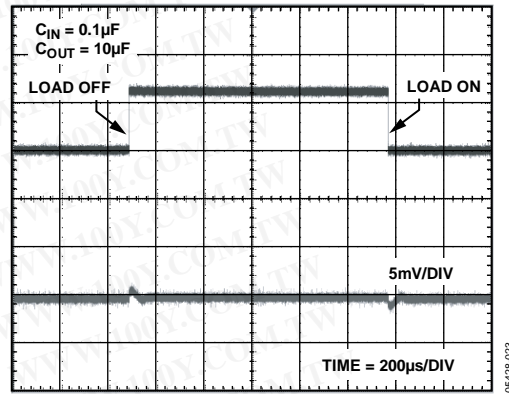

Figure 24. ADR441 Load Transient Response

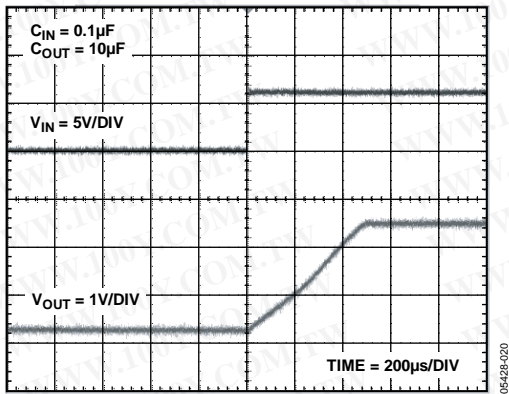

Figure 22. ADR441 Turn-On Response

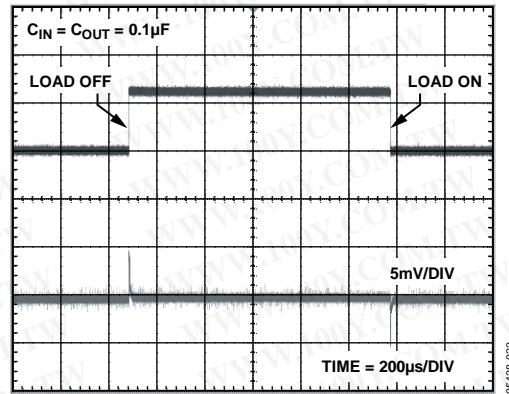

Figure 25. ADR441 Load Transient Response

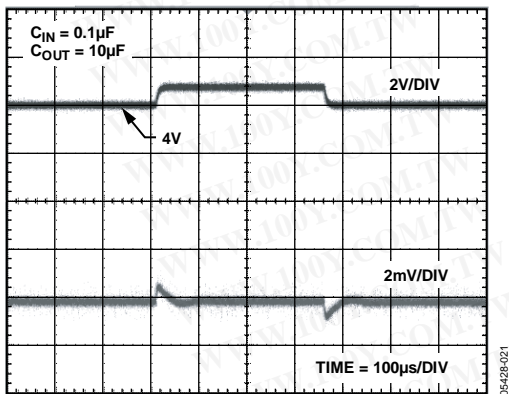

Figure 23. ADR441 Line Transient Response

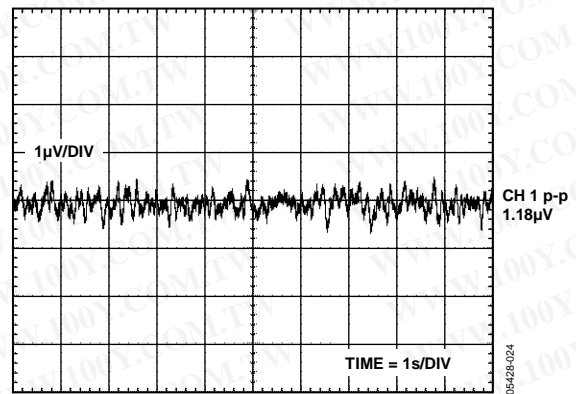

Figure 26. ADR441 0.1 Hz to 10.0 Hz Voltage Noise

ADR440/ADR441/ADR443/ADR444/ADR445

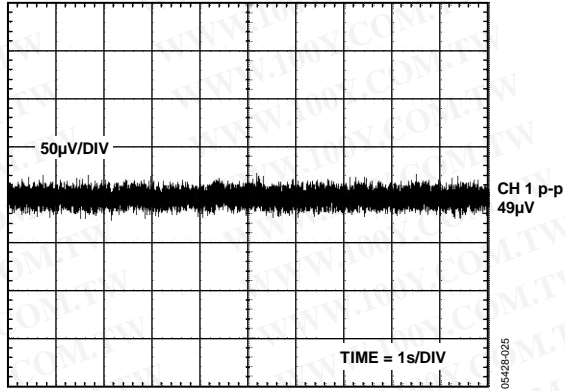

Figure 27. ADR441 10 Hz to 10 kHz Voltage Noise

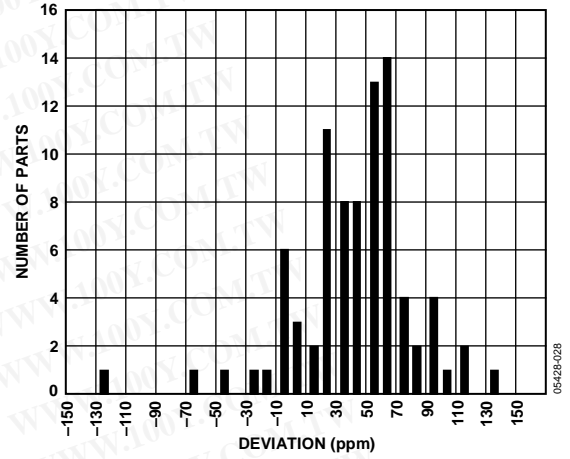

Figure 30. ADR441 Typical Output Voltage Hysteresis

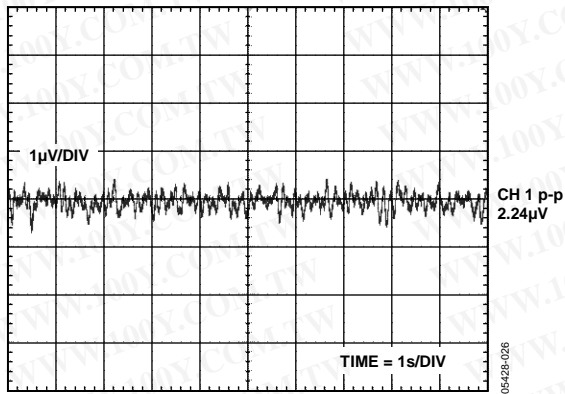

Figure 28. ADR445 0.1 Hz to 10.0 Hz Voltage Noise

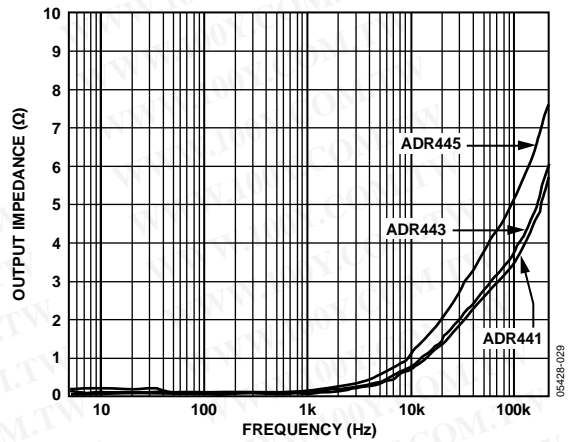

Figure 31. Output Impedance vs. Frequency

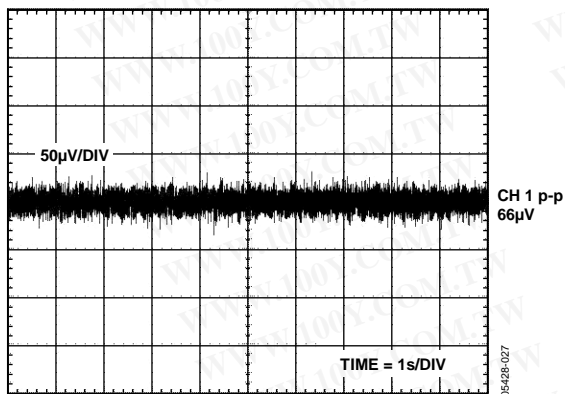

Figure 29. ADR445 10 Hz to 10 kHz Voltage Noise

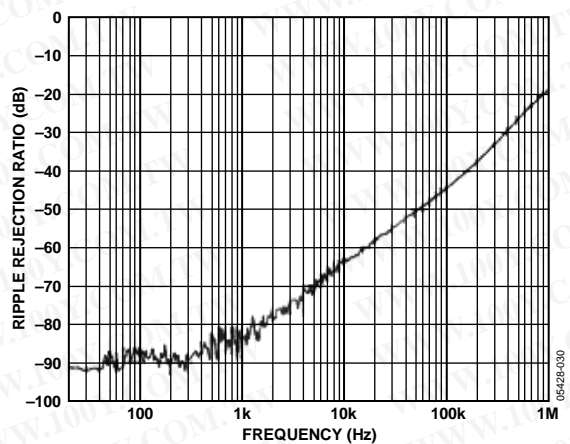

Figure 32. Ripple Rejection Ratio vs. Frequency

ADR440/ADR441/ADR443/ADR444/ADR445

THEORY OF OPERATION

The ADR44x series of references uses a new reference generation technique known as XFET (eXtra implanted junction FET). This technique yields a reference with low dropout, good thermal hysteresis, and exceptionally low noise. The core of the XFET reference consists of two junction field-effect transistors (JFETs), one of which has an extra channel implant to raise its pinch-off voltage. By running the two JFETs at the same drain current, the difference in pinch-off voltage can be amplified and used to form a highly stable voltage reference.

The intrinsic reference voltage is around 0.5 V with a negative temperature coefficient of about $-120 \text{ ppm}/^\circ\text{C}$. This slope is essentially constant to the dielectric constant of silicon, and it can be closely compensated for by adding a correction term generated in the same fashion as the proportional-to-absolute temperature (PTAT) term used to compensate band gap references. The advantage of an XFET reference is its correction term, which is approximately 20 times lower and requires less correction than that of a band gap reference. Because most of the noise of a band gap reference comes from the temperature compensation circuitry, the XFET results in much lower noise.

Figure 33 shows the basic topology of the ADR44x series. The temperature correction term is provided by a current source with a value designed to be proportional to the absolute temperature. The general equation is

$$V_{OUT} = G (\Delta V_P - R1 \times I_{PTAT}) \quad (1)$$

where:

G is the gain of the reciprocal of the divider ratio.
 ΔV_P is the difference in pinch-off voltage between the two JFETs.
 I_{PTAT} is the positive temperature coefficient correction current.

ADR44x devices are created by on-chip adjustment of $R2$ and $R3$ to achieve the different voltage options at the reference output.

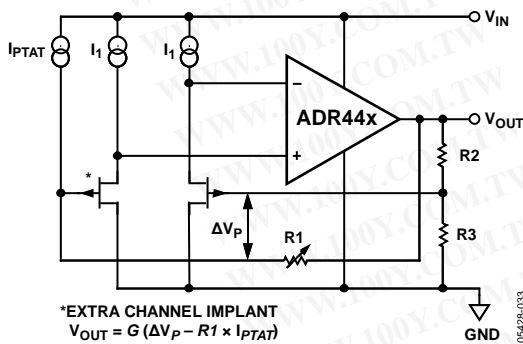

Figure 33. Simplified Schematic Device

POWER DISSIPATION CONSIDERATIONS

The ADR44x family of references is guaranteed to deliver load currents to 10 mA with an input voltage that ranges from 3 V to 18 V. When these devices are used in applications at higher currents, use the following equation to account for the temperature effects of increases in power dissipation:

$$T_J = P_D \times \theta_{JA} + T_A \quad (2)$$

where:

T_J and T_A are the junction and ambient temperatures, respectively.

P_D is the device power dissipation.

θ_{JA} is the device package thermal resistance.

BASIC VOLTAGE REFERENCE CONNECTIONS

The ADR44x family requires a $0.1 \mu\text{F}$ capacitor on the input and the output for stability. Although not required for operation, a $10 \mu\text{F}$ capacitor at the input can help with line voltage transient performance.

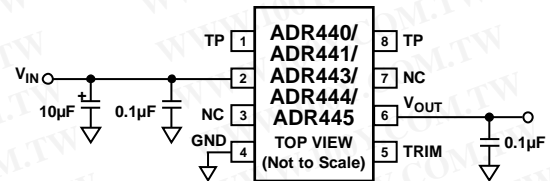

- NOTES
 1. NC = NO CONNECT
 2. TP = TEST PIN (DO NOT CONNECT)

Figure 34. Basic Voltage Reference Configuration

NOISE PERFORMANCE

The noise generated by the ADR44x family of references is typically less than $1.4 \mu\text{V p-p}$ over the 0.1 Hz to 10.0 Hz band for ADR440, ADR441, and ADR443. Figure 26 shows the 0.1 Hz to 10 Hz noise of the ADR441, which is only $1.2 \mu\text{V p-p}$. The noise measurement is made with a band-pass filter composed of a 2-pole high-pass filter with a corner frequency at 0.1 Hz and a 2-pole low-pass filter with a corner frequency at 10.0 Hz.

TURN-ON TIME

Upon application of power (cold start), the time required for the output voltage to reach its final value within a specified error band is defined as the turn-on settling time. Two components normally associated with this are the time for the active circuits to settle and the time for the thermal gradients on the chip to stabilize. Figure 20 and Figure 21 show the turn-on and turn-off settling times for the ADR441.

APPLICATIONS INFORMATION

OUTPUT ADJUSTMENT

The ADR44x family features a TRIM pin that allows the user to adjust the output voltage of the part over a limited range. This allows errors from the reference and overall system errors to be trimmed out by connecting a potentiometer between the output and the ground, with the wiper connected to the TRIM pin. Figure 35 shows the optimal trim configuration. R1 allows fine adjustment of the output and is not always required. R_P should be sufficiently large so that the maximum output current from the ADR44x is not exceeded.

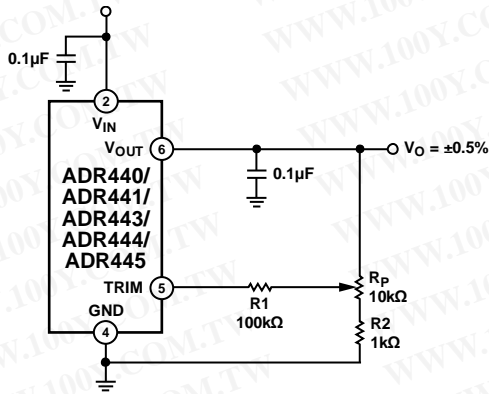

Figure 35. ADR44x Trim Function

Using the trim function has a negligible effect on the temperature performance of the ADR44x. However, all resistors need to be low temperature coefficient resistors, or errors may occur.

BIPOLAR OUTPUTS

By connecting the output of the ADR44x to the inverting terminal of an operational amplifier, it is possible to obtain both positive and negative reference voltages. Care must be taken when choosing Resistors R1 and R2 (see Figure 36). These resistors must be matched as closely as possible to ensure minimal differences between the negative and positive outputs. In addition, care must be taken to ensure performance over temperature. Use low temperature coefficient resistors if the circuit is used over temperature; otherwise, differences exist between the two outputs.

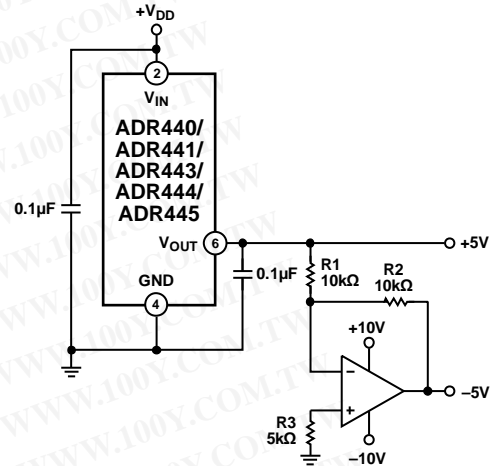

Figure 36. ADR44x Bipolar Outputs

PROGRAMMABLE VOLTAGE SOURCE

To obtain different voltages than those offered by the ADR44x, some extra components are needed. In Figure 37, two potentiometers are used to set the desired voltage and the buffering amplifier provides current drive. The potentiometer connected between V_{OUT} and GND, with its wiper connected to the noninverting input of the operational amplifier, takes care of coarse trim. The second potentiometer, with its wiper connected to the trim terminal of the ADR44x, is used for fine adjustment. Resolution depends on the end-to-end resistance value and the resolution of the selected potentiometer.

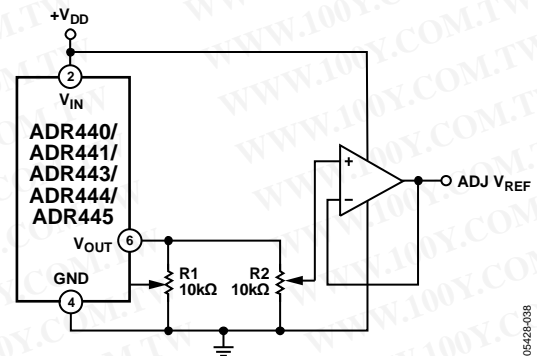

Figure 37. Programmable Voltage Source

For a completely programmable solution, replace the two potentiometers in Figure 37 with one Analog Devices dual digital potentiometer, offered with either an SPI or an I²C interface. These interfaces set the position of the wiper on both potentiometers and allow the output voltage to be set. Table 9 lists compatible Analog Devices digital potentiometers.

ADR440/ADR441/ADR443/ADR444/ADR445

Table 9. Digital Potentiometer Parts

Part No.	No. of Channels	No. of Positions	ITF	R (k Ω)	V _{DD} ¹ (V)
AD5251	2.00	64.00	I ² C	1, 10, 50, 100	5.5
AD5207	2.00	256.00	SPI	10, 50, 100	5.5
AD5242	2.00	256.00	I ² C	10, 100, 1M	5.5
AD5262	2.00	256.00	SPI	20, 50, 200	15
AD5282	2.00	256.00	I ² C	20, 50, 100	15
AD5252	2.00	256.00	I ² C	1, 10, 50, 100	5.5
AD5232	2.00	256.00	SPI	10, 50, 100	5.5
AD5235	2.00	1024.00	SPI	25, 250	5.5
ADN2850	2.00	1024.00	SPI	25, 250	5.5

¹ Can also use a negative supply.

Adding a negative supply to the operational amplifier allows the user to produce a negative programmable reference by connecting the reference output to the inverting terminal of the operational amplifier. Choose feedback resistors to minimize errors over temperature.

PROGRAMMABLE CURRENT SOURCE

It is possible to build a programmable current source using a setup similar to the programmable voltage source, as shown in Figure 38. The constant voltage on the gate of the transistor sets the current through the load. Varying the voltage on the gate changes the current. This circuit does not require a dual digital potentiometer.

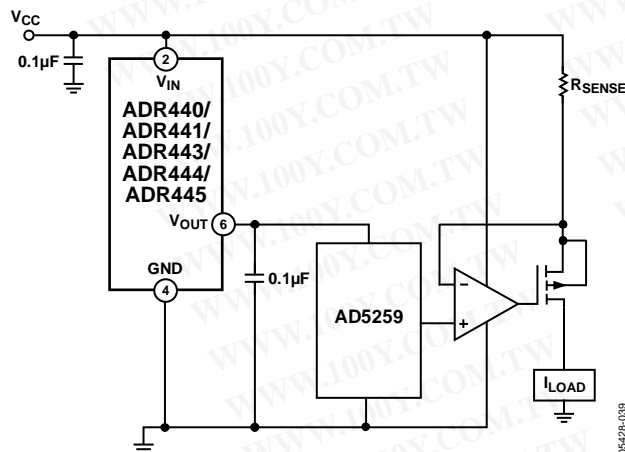

Figure 38. Programmable Current Source

HIGH VOLTAGE FLOATING CURRENT SOURCE

Use the circuit in Figure 39 to generate a floating current source with minimal self heating. This particular configuration can operate on high supply voltages, determined by the breakdown voltage of the N-channel JFET.

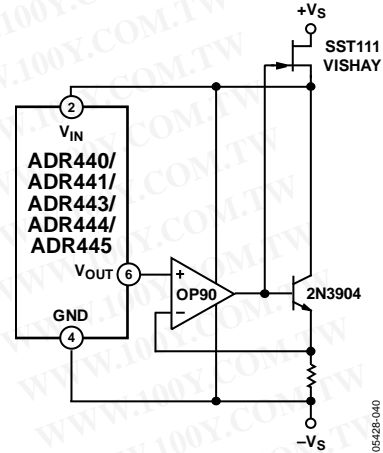

Figure 39. Floating Current Source

PRECISION OUTPUT REGULATOR (BOOSTED REFERENCE)

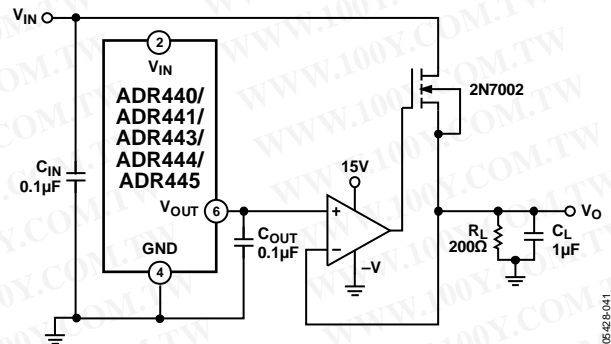
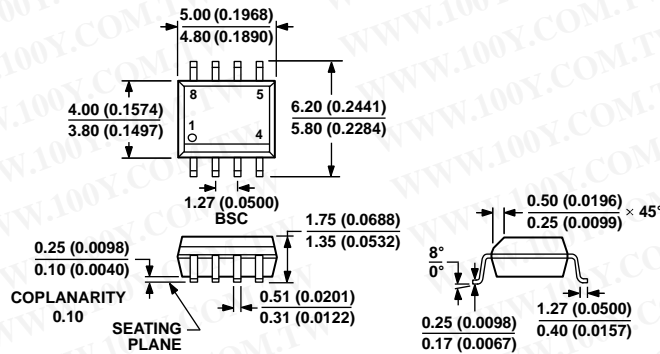

Figure 40. Boosted Output Reference

Higher current drive capability can be obtained without sacrificing accuracy by using the circuit in Figure 40. The operational amplifier regulates the MOSFET turn-on, forcing V_O to equal the V_{REF}. Current is then drawn from V_{IN}, allowing increased current drive capability. The circuit allows a 50 mA load; if higher current drive is required, use a larger MOSFET. For fast transient response, add a buffer at V_O to aid with capacitive loading.

OUTLINE DIMENSIONS



COMPLIANT TO JEDEC STANDARDS MS-012-AA
 CONTROLLING DIMENSIONS ARE IN MILLIMETERS; INCH DIMENSIONS
 (IN PARENTHESES) ARE ROUNDED-OFF MILLIMETER EQUIVALENTS FOR
 REFERENCE ONLY AND ARE NOT APPROPRIATE FOR USE IN DESIGN.

Figure 41. 8-Lead Standard Small Outline Package [SOIC_N]
 Narrow Body
 (R-8)
 Dimensions shown in millimeters and (inches)

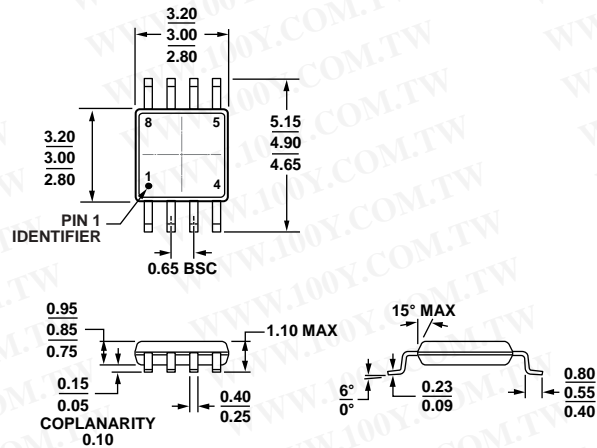

COMPLIANT TO JEDEC STANDARDS MO-187-AA

Figure 42. 8-Lead Mini Small Outline Package [MSOP]
 (RM-8)
 Dimensions show in millimeters

ADR440/ADR441/ADR443/ADR444/ADR445

ORDERING GUIDE

Model ¹	Output Voltage (V)	Initial Accuracy		Temperature Coefficient Package (ppm/°C)	Package Description	Branding	Temperature Range	Package Option
		±mV	%					
ADR440ARZ	2.048	3	0.15	10	8-Lead SOIC_N		-40°C to +125°C	R-8
ADR440ARZ-REEL7	2.048	3	0.15	10	8-Lead SOIC_N		-40°C to +125°C	R-8
ADR440ARMZ	2.048	3	0.15	10	8-Lead MSOP	R01	-40°C to +125°C	RM-8
ADR440ARMZ-REEL7	2.048	3	0.15	10	8-Lead MSOP	R01	-40°C to +125°C	RM-8
ADR440BRZ	2.048	1	0.05	3	8-Lead SOIC_N		-40°C to +125°C	R-8
ADR440BRZ-REEL7	2.048	1	0.05	3	8-Lead SOIC_N		-40°C to +125°C	R-8
ADR441ARZ	2.500	3	0.12	10	8-Lead SOIC_N		-40°C to +125°C	R-8
ADR441ARZ-REEL7	2.500	3	0.12	10	8-Lead SOIC_N		-40°C to +125°C	R-8
ADR441ARMZ	2.500	3	0.12	10	8-Lead MSOP	R02	-40°C to +125°C	RM-8
ADR441ARMZ-REEL7	2.500	3	0.12	10	8-Lead MSOP	R02	-40°C to +125°C	RM-8
ADR441BRZ	2.500	1	0.04	3	8-Lead SOIC_N		-40°C to +125°C	R-8
ADR441BRZ-REEL7	2.500	1	0.04	3	8-Lead SOIC_N		-40°C to +125°C	R-8
ADR443ARZ	3.000	4	0.13	10	8-Lead SOIC_N		-40°C to +125°C	R-8
ADR443ARZ-REEL7	3.000	4	0.13	10	8-Lead SOIC_N		-40°C to +125°C	R-8
ADR443ARMZ	3.000	4	0.13	10	8-Lead MSOP	R03	-40°C to +125°C	RM-8
ADR443ARMZ-REEL7	3.000	4	0.13	10	8-Lead MSOP	R03	-40°C to +125°C	RM-8
ADR443BRZ	3.000	1.2	0.04	3	8-Lead SOIC_N		-40°C to +125°C	R-8
ADR443BRZ-REEL7	3.000	1.2	0.04	3	8-Lead SOIC_N		-40°C to +125°C	R-8
ADR444ARZ	4.096	5	0.13	10	8-Lead SOIC_N		-40°C to +125°C	R-8
ADR444ARZ-REEL7	4.096	5	0.13	10	8-Lead SOIC_N		-40°C to +125°C	R-8
ADR444ARMZ	4.096	5	0.13	10	8-Lead MSOP	R04	-40°C to +125°C	RM-8
ADR444ARMZ-REEL7	4.096	5	0.13	10	8-Lead MSOP	R04	-40°C to +125°C	RM-8
ADR444BRZ	4.096	1.6	0.04	3	8-Lead SOIC_N		-40°C to +125°C	R-8
ADR444BRZ-REEL7	4.096	1.6	0.04	3	8-Lead SOIC_N		-40°C to +125°C	R-8
ADR445ARZ	5.000	6	0.12	10	8-Lead SOIC_N		-40°C to +125°C	R-8
ADR445ARZ-REEL7	5.000	6	0.12	10	8-Lead SOIC_N		-40°C to +125°C	R-8
ADR445ARMZ	5.000	6	0.12	10	8-Lead MSOP	R05	-40°C to +125°C	RM-8
ADR445ARMZ-REEL7	5.000	6	0.12	10	8-Lead MSOP	R05	-40°C to +125°C	RM-8
ADR445BRZ	5.000	2	0.04	3	8-Lead SOIC_N		-40°C to +125°C	R-8
ADR445BRZ-REEL7	5.000	2	0.04	3	8-Lead SOIC_N		-40°C to +125°C	R-8

¹ Z = RoHS Compliant Part.

NOTES

ADR440/ADR441/ADR443/ADR444/ADR445

NOTES

勝特力材料 886-3-5753170
勝特力电子(上海) 86-21-34970699
勝特力电子(深圳) 86-755-83298787
[Http://www.100y.com.tw](http://www.100y.com.tw)

I²C refers to a communications protocol originally developed by Philips Semiconductors (now NXP Semiconductors).

©2005–2010 Analog Devices, Inc. All rights reserved. Trademarks and registered trademarks are the property of their respective owners.
D05428-0-11/10(E)



www.analog.com