



600mA Low Dropout Linear Regulator

Description

The FP6132 series are low dropout, positive linear regulators with very low quiescent current. The FP6132 can supply 600mA output current with a low dropout voltage at about 600mV.

The FP6132 regulator is able to operate with output capacitors as small as 1μF for stability. The FP6132 also offers on chip thermal shutdown feature providing protection against overload or any condition when the ambient temperature exceeds the junction temperature.

The FP6132 series are available in fixed output voltage ranging from 1.2V to 4.5V with 0.1V interval.

The FP6132 series are available in space-saving SOT-23, SOT-89, SOT-223 and TSOT-23 packages.

Features

- Low Dropout Voltage of 600mV at 600mA
- Guaranteed 600mA Output Current
- Very Low Quiescent Current at about 30uA
- Max. ±2% Output Accuracy
- Needs Only 1μF Capacitor for Stability
- Thermal Shutdown Protection
- Current Limit Protection
- Low-ESR Ceramic Capacitor for Output Stability
- RoHS Compliant

Applications

- DVD/CD-ROMs, CD/RWs
- Wireless Devices
- LCD Modules
- Battery Power Systems
- Card Readers
- XDSL Routers

Pin Assignments

GS3 Package (SOT-23)

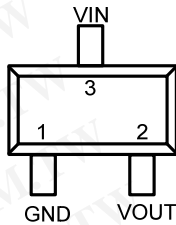

GB3 Package (SOT- 89)

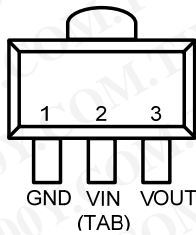

VB3 Package (SOT- 89)

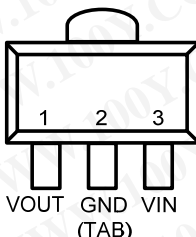

Ordering Information

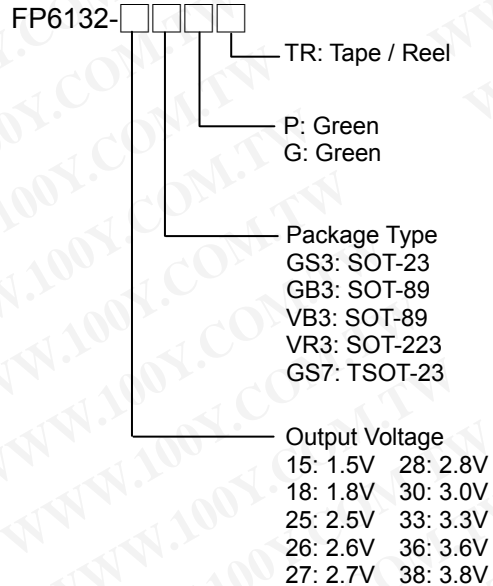

Note1 : Please consult Fitipower sales office or authorized distributor for availability of special output voltages.

VR3 Package (SOT-223)

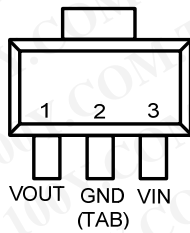

GS7 Package (TSOT-23)

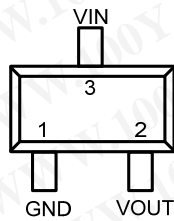

Figure1. Pin Assignment of FP6132

SOT-23-3 Marking

Part Number	Product Code	Part Number	Product Code
FP6132-15GS3G	U7=	FP6132-28GS3G	Br=
FP6132-18GS3P	Bk	FP6132-30GS3P	Bs
FP6132-18GS3G	Bk=	FP6132-30GS3G	Bs=
FP6132-25GS3P	Bm	FP6132-33GS3P	Bt
FP6132-25GS3G	Bm=	FP6132-33GS3G	Bt=
FP6132-26GS3G	L3=	FP6132-36GS3P	Bu
FP6132-27GS3P	Bn	FP6132-36GS3G	Bu=
FP6132-27GS3G	Bn=	FP6132-38GS3G	m0=
FP6132-28GS3P	Br		

TSOT-23-3 Marking

Part Number	Product Code	Part Number	Product Code
FP6132-30GS7G	t1G	FP6132-33GS7G	t2G

Typical Application Circuit

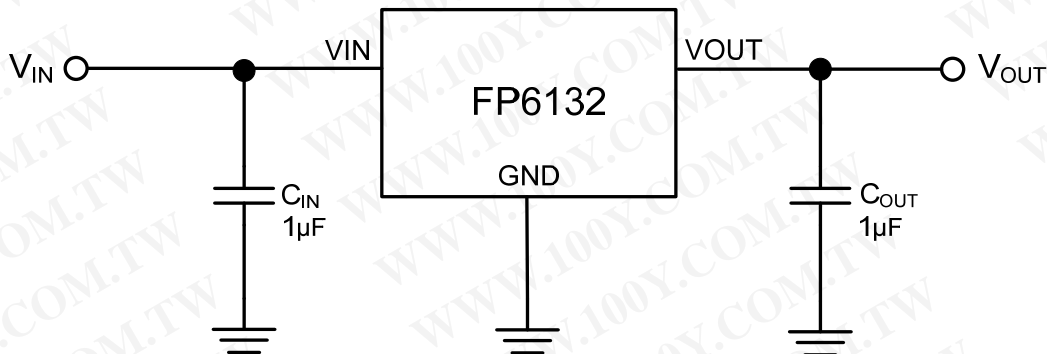

Figure2. Typical Application Circuit of FP6132

Note2 : To prevent oscillation, it is recommended to use minimum 1µF X7R or X5R dielectric capacitors if ceramics are used as input/output capacitors.

Functional Pin Description

Pin Name	Pin Function
VIN	Power is supplied to this device from this pin which is required an input filter capacitor. In general, the input capacitor in the range of 1µF to 10µF is sufficient.
VOUT	The output supplies power to loads. The output capacitor is required to prevent output voltage unstable. The FP6132 is stable with an output capacitor 1µF or greater. The larger output capacitor will be required for application with large transit load to limit peak voltage transits, besides could reduce output noise, improve stability, PSRR.
GND	Common ground pin

Block Diagram

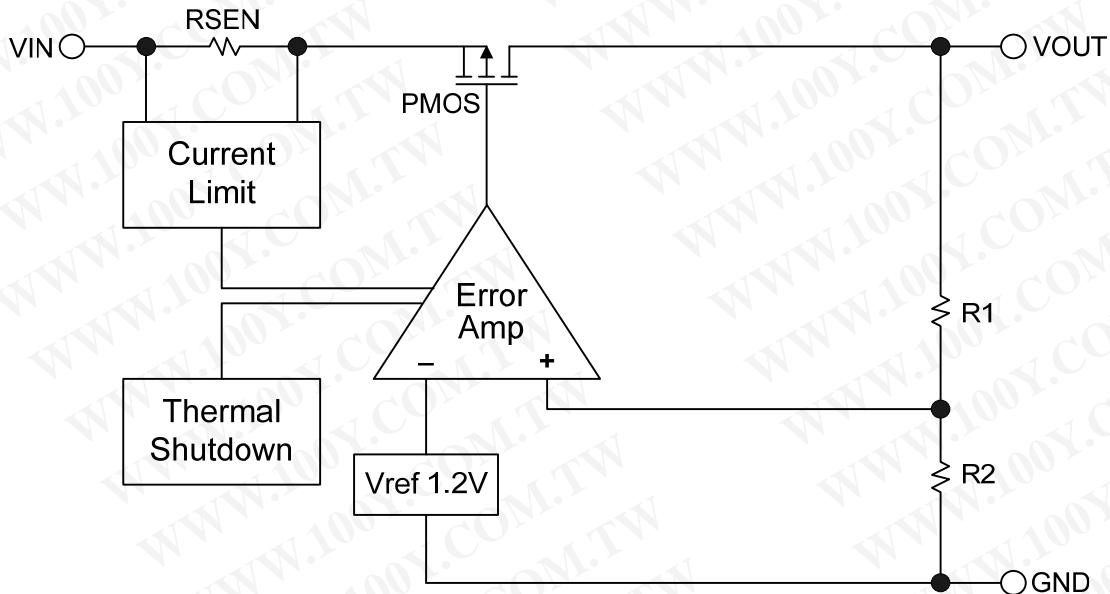

Figure3. Block Diagram of FP6132

Absolute Maximum Ratings

- Supply Input Voltage (V_{IN}) ----- + 6V
- Power Dissipation @25°C (P_D)
 - SOT-23 / TSOT-23 ----- + 0.4W
 - SOT-89 ----- + 0.57W
 - SOT-223 ----- + 0.74W
- Package Thermal Resistance (θ_{JA})
 - SOT-23 / TSOT-23 ----- + 250°C/W
 - SOT-89 ----- + 175°C/W
 - SOT-223 ----- + 135°C/W
- Maximum Junction Temperature (T_J) ----- + 150°C
- Storage Temperature Range (T_S) ----- - 65°C to + 150°C
- Lead Temperature (Soldering, 10 sec.) (T_{LEAD}) ----- + 260°C

Note3 : Stresses beyond those listed under "Absolute Maximum Ratings" may cause permanent damage to the device.

Recommended Operating Conditions

- Input Voltage (V_{IN}) ----- + 2.8V to + 5.5V
- Operating Temperature Range (T_{OPR}) ----- - 40°C to + 85°C

Electrical Characteristics

($V_{IN}=V_{OUT}+1V$ or $V_{IN}=2.8V$ whichever is greater, $C_{IN}=1\mu F$, $C_{OUT}=1\mu F$, $T_A=25\text{ }^\circ\text{C}$, unless otherwise specified)

Parameter	Symbol	Conditions	Min	Typ	Max	Unit
Output Voltage Accuracy	ΔV_{OUT}	$I_O = 1\text{mA}$	-2		+2	%
Current Limit	I_{LIMIT}	$R_{Load}=1\Omega$	600			mA
Quiescent Current	I_Q	$I_O = 0\text{mA}$		30	50	μA
Dropout Voltage (Note4)	V_{DROP}	$I_O=600\text{mA}$	$V_{OUT}=1.5V$	1550	1690	mV
			$V_{OUT}=1.8V$	1300	1420	
			$V_{OUT}=2.5V$	800	900	
			$V_{OUT}=3.0V$	650	730	
			$V_{OUT}=3.3V$	600	670	
Line Regulation	ΔV_{LINE}	$I_O=1\text{mA}$, $V_{IN}=V_{OUT} +1V$ to 5V		1	5	mV
Load Regulation (Note5)	ΔV_{LOAD}	$I_O=0\text{mA}$ to 600mA		13	50	mV
Ripple Rejection (Note6)	PSRR	$V_{IN}=V_{OUT}+1V$ $f_{RIPPLE} = 120\text{Hz}$, $C_{OUT} = 1\mu F$		60		dB
Temperature Coefficient (Note6)	T.C.	$I_{OUT} = 1\text{mA}$, $V_{IN} = 5V$		50		ppm/ $^\circ\text{C}$
Thermal Shutdown Temperature (Note6)	T_{SD}			160		$^\circ\text{C}$
	ΔT_{SD}	Hysteresis		25		$^\circ\text{C}$

Note4 : The dropout voltage is defined as $V_{IN}-V_{OUT}$, which is measured when V_{OUT} drops 2% of its normal value with the specified output current.

Note5 : Load regulation and dropout voltage are measured at a constant junction temperature by using a 40ms low duty cycle current pulse.

Note6 : Guarantee by design.



Typical Performance Curves

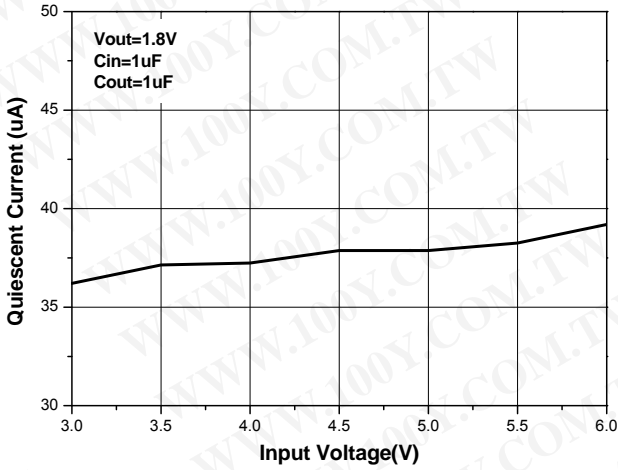

Figure4. Quiescent Current vs. Input Voltage

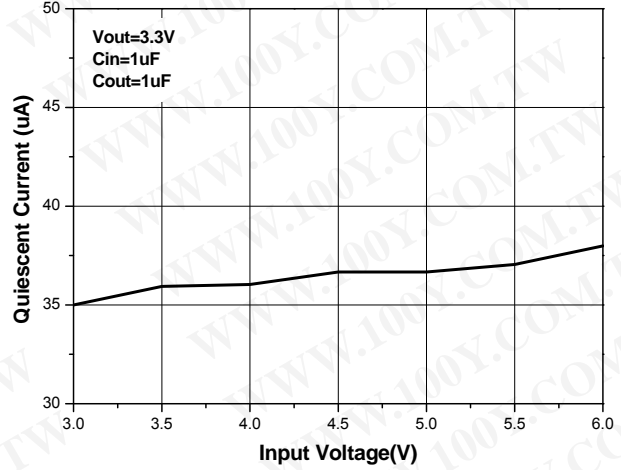

Figure5. Quiescent Current vs. Input Voltage

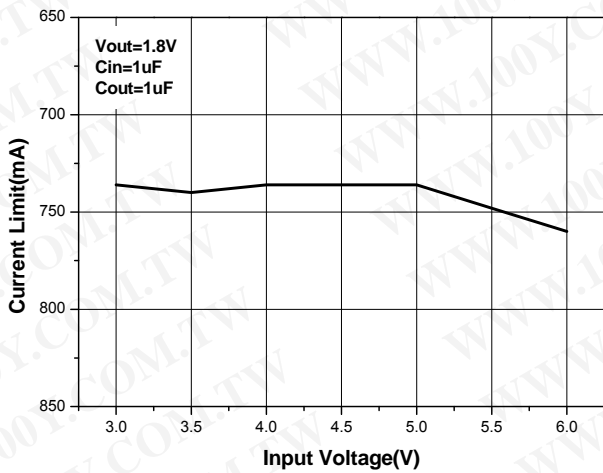

Figure6. Current limit vs. Input Voltage

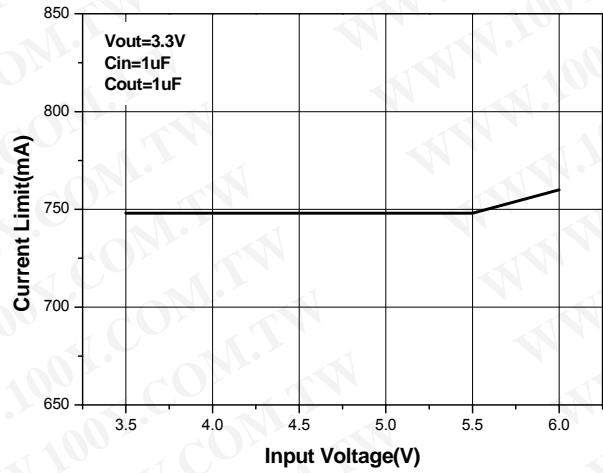

Figure7. Current Limit vs. Input Voltage

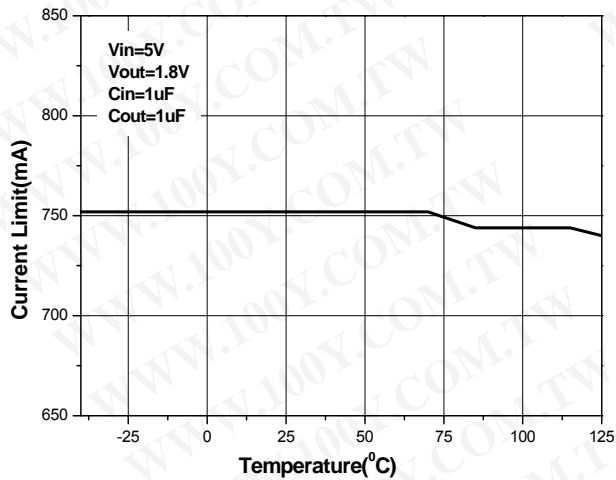

Figure8. Current limit vs. Temperature

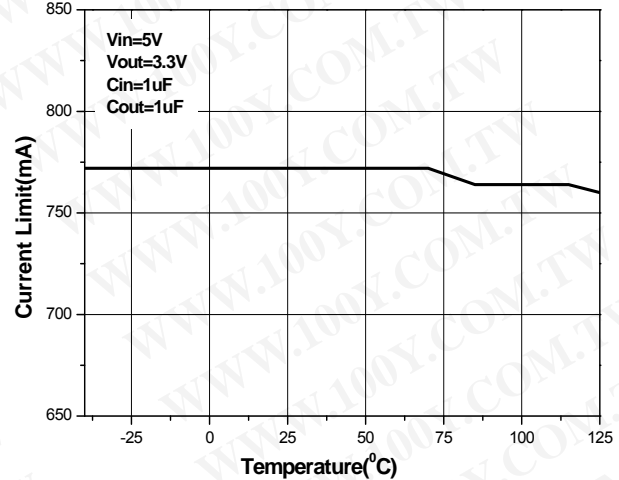

Figure9. Current limit vs. Temperature

Typical Performance Curves (Continued)

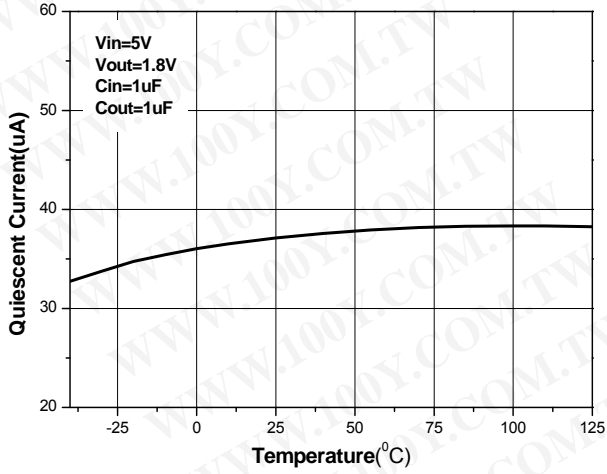

Figure10. Quiescent Current vs. Temperature

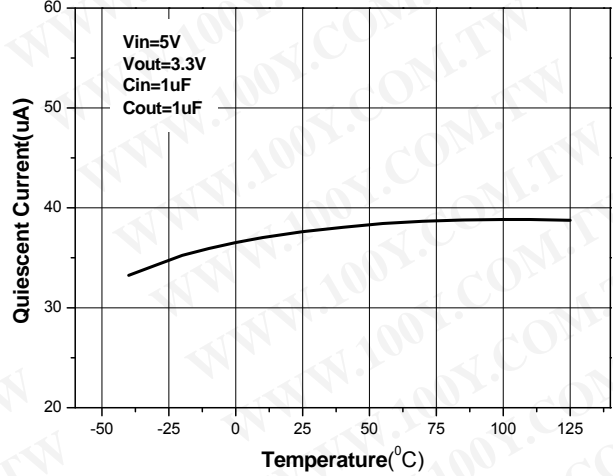

Figure11. Quiescent Current vs. Temperature

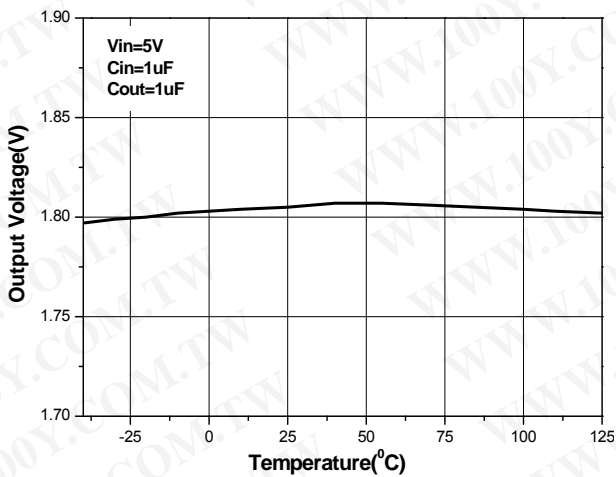

Figure12. Temperature Stability

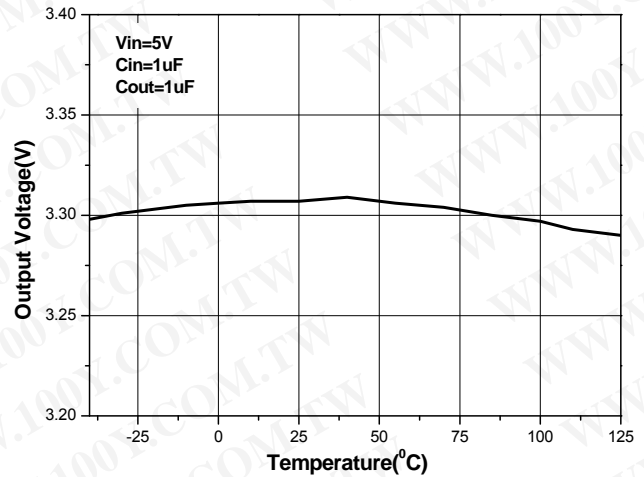

Figure13. Temperature Stability

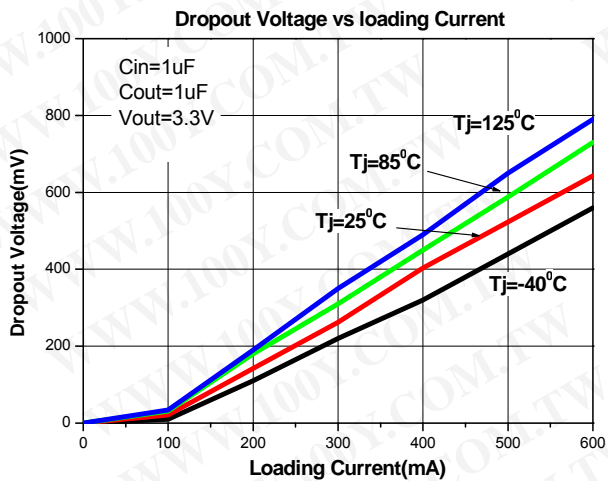

Figure14. Dropout Voltage vs. Loading Current

Typical Performance Curves (Continued)

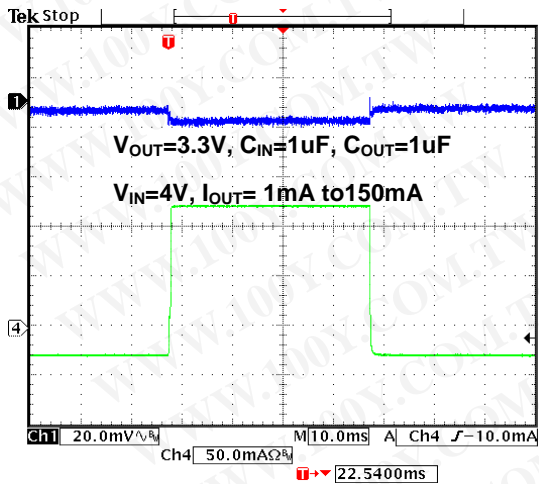

Figure15. Load Transition Response

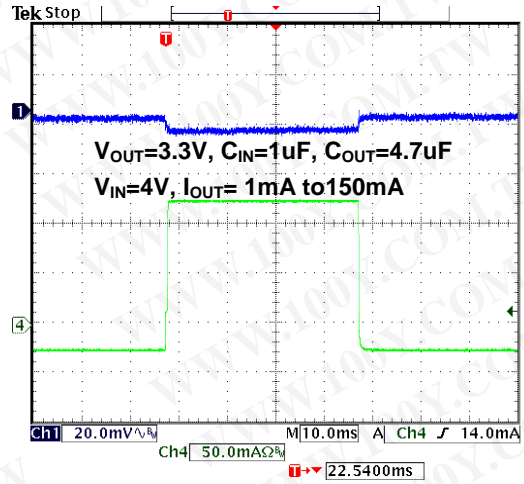

Figure16. Load Transition Response

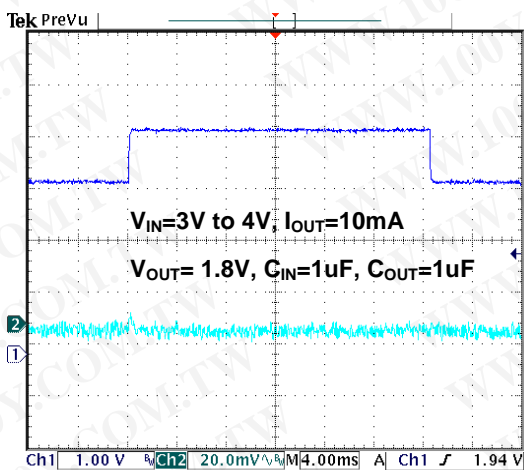

Figure17. Line Transition Response

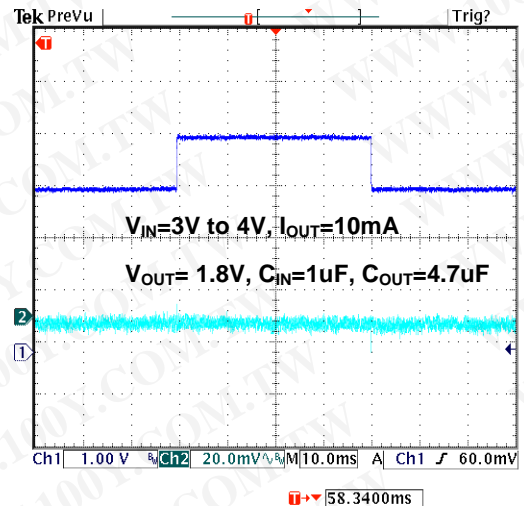

Figure18. Line Transition Response

Application Information

The FP6132 series are low dropout linear regulators that could provide 600mA output current at dropout voltage about 600mV. Besides, current limit and on chip thermal shutdown features provide protection against any combination of overload or ambient temperature that could exceed junction temperature.

Output and Input Capacitor

The FP6132 regulator is designed to be stable with a wide range of output capacitors. The ESR of the output capacitor affects stability. Larger value of the output capacitor decreases the peak deviations and provides to improve transition response for larger current changes.

The capacitor types (aluminum, ceramic, and tantalum) have different characterizations such as temperature and voltage coefficients. All ceramic capacitors are manufactured with a variety of dielectrics, each with different behavior across temperature and applications. Common dielectrics used are X5R, X7R and Y5V. It is recommended to use 1uF to 10uF X5R or X7R dielectric ceramic capacitors with 30mΩ to 50mΩ ESR range between device outputs to ground for transient stability. The FP6132 is designed to be stable with low ESR ceramic capacitors and higher values of capacitors and ESR could improve output stability.

So the ESR of output capacitor is very important because it generates a zero to provide phase lead for loop stability.

There are no requirements for the ESR on the input capacitor, but its voltage and temperature coefficient have to be considered for device application environment.

Protection Features

In order to prevent overloading or thermal condition from damaging device, FP6132 regulator has internal thermal and current limiting functions designed to protect the device. It will rapidly shut off PMOS pass element during over temperature condition.

Thermal Consideration

The power handling capability of the device will be limited by allowable operation junction temperature (125°C). The power dissipated by the device will be estimated by $P_D = I_{OUT} \times (V_{IN} - V_{OUT})$. The power dissipation should be lower than the maximum power dissipation listed in "Absolute Maximum Ratings" section.

Outline Information

SOT-23-3 Package (Unit: mm)

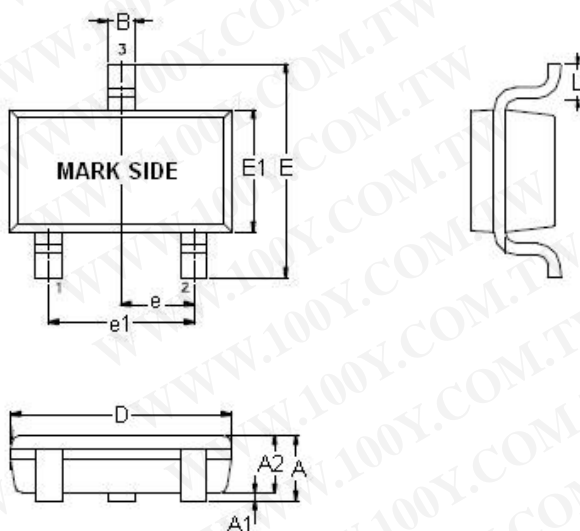

SYMBOL S UNIT	DIMENSION IN MILLIMETER	
	MIN	MAX
A	1.00	1.20
A1	0.00	0.10
A2	1.00	1.10
B	0.35	0.50
D	2.80	3.00
E	2.60	3.00
E1	1.50	1.70
e	0.90	1.00
e1	1.80	2.00
L	0.35	0.55

SOT- 89-3 Package (Unit: mm)

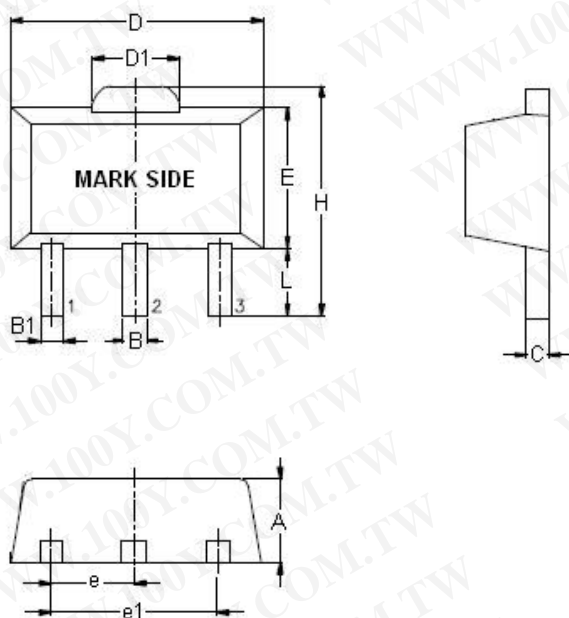

SYMBOL S UNIT	DIMENSION IN MILLIMETER	
	MIN	MAX
A	1.40	1.60
L	0.89	1.20
B	0.44	0.56
B1	0.36	0.48
C	0.35	0.44
D	4.40	4.60
D1	1.35	1.83
H	3.94	4.25
E	2.29	2.60
e	1.45	1.55
e1	2.90	3.10

Note :Followed From JEDEC TO-243-C.

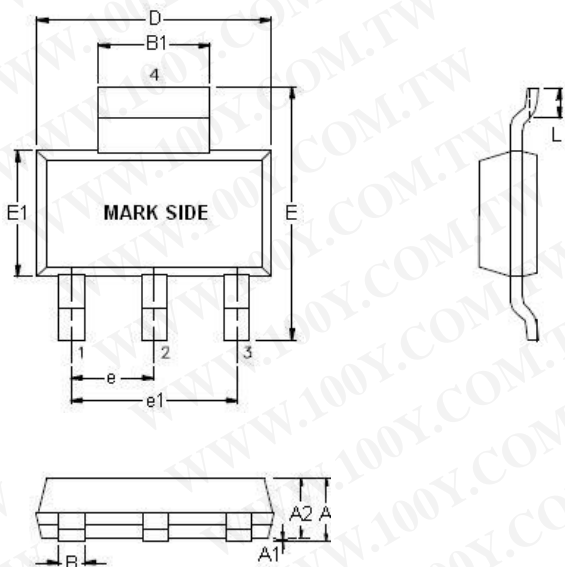
Outline Information (Continued)
SOT-223 Package (Unit: mm)

SYMBOL S UNIT	DIMENSION IN MILLIMETER	
	MIN	MAX
A	1.55	1.80
A1	0.05	0.10
A2	1.50	1.70
B	0.60	0.84
B1	2.85	3.10
D	6.30	6.70
E	6.70	7.30
e	2.20	2.40
e1	4.50	4.70
L	0.75	0.85

Note : Followed From JEDEC TO-261-C.

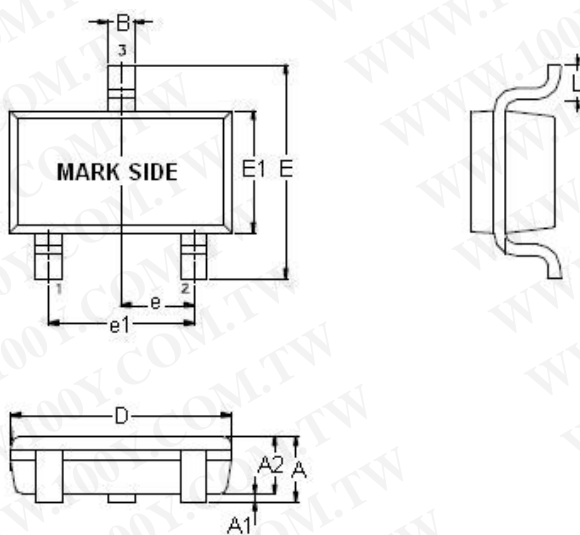
TSOT-23-3 Package (Unit: mm)

SYMBOL S UNIT	DIMENSION IN MILLIMETER	
	MIN	MAX
A	0.75	0.90
A1	0.00	0.10
A2	0.70	0.80
B	0.35	0.50
D	2.80	3.00
E	2.60	3.00
E1	1.50	1.70
e	0.90	1.00
e1	1.80	2.00
L	0.35	0.60

Life Support Policy

Fitipower's products are not authorized for use as critical components in life support devices or other medical systems.