

Sync. Rectifier Step Up Converter

Features

- Up to 90% Efficiency at $I_{OUT}=2A$ $V_{OUT} = 5V$ from 3.3V Input
- Low 70 μA Quiescent Current
- Guaranteed 3A Output Current at $V_{OUT} = 5V$ from 3.3V Input
- 1MHz PWM Switching Frequency
- Synchronous and Embedded Power Mosfets; No Schottky Diode Required
- Internal Soft-Start to Limit Inrush Current
- Adjustable Output
- Output turn off true shutdown function
- Current Mode Operation with Internal Compensation for Excellent Line and Load Transient Response
- Overload/Short-Circuit Protection with hiccup control
- Shutdown Current <1 μA
- Thermal Shutdown
- Compact 8 pin, SOP8 (FD) package

Application

- iPad-like computers, smart phones and portable handheld devices.

General Description

The G5177B is a compact, high-efficiency, synchronous step-up converter with power Mosfets embedded and with output turn off true shutdown function and adjustable output current limiting with foldback for a single-cell Li-ion/polymer battery. The G5177B uses only 70 μA (typ) quiescent current and allows the converter to switch only when needed at no load and light loads, and when load is higher than 100mA, it uses fixed-frequency PWM technique at 1MHz. It features a current mode control for fast transient response with internal compensation. The G5177B includes cycle-by-cycle current limit to maximum inductor current and over-temperature protection circuit. The G5177B is suitable for iPad-like computers, smart phones and portable handheld devices.

The G5177B is available in a SOP8 (FD) package. The operating temperature range is from -45°C to +85°C.

勝特力材料 886-3-5753170
 勝特力电子(上海) 86-21-34970699
 勝特力电子(深圳) 86-755-83298787
[Http://www.100y.com.tw](http://www.100y.com.tw)

Ordering Information

ORDER NUMBER	MARKING	TEMP. RANGE	PACKAGE (Green)
G5177BF11U	G5177B	0°C to +85°C	SOP-8 (FD)

Note: F1:SOP-8 (FD)

1: Bonding Code

U: Tape & Reel

Pin Configuration

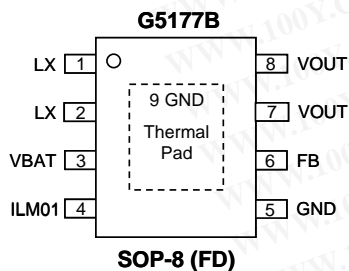

Note: Recommend connecting the Thermal Pad to the Ground for excellent power dissipation.

Typical Application Circuit

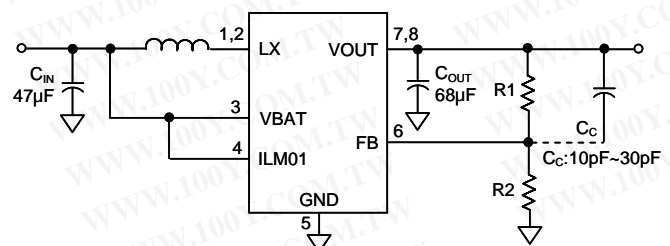

$V_{OUT} = V_{REF} * (1 + R1/R2)$, where V_{REF} typical is 1.23V.

Absolute Maximum Ratings

V _{OUT} to GND	-0.3V to 6V	Thermal Resistance of Junction to Ambient (θ_{JA})	
LX to GND	-0.3V to 6V	SOP-8 (FD)	TBD
ILIM0 to GND	-0.3V to 6V	Continuous Power Dissipation ($T_A = +25^\circ\text{C}$)	
ILIM1 to GND	-0.3V to 6V	SOP-8 (FD)	TBD
FB to GND	-0.3V to 6V	Storage Temperature	-55~150°C
BAT to GND	-0.3V to 6V	Operation Temperature	-40~85°C

Electrical Characteristics

(V_{OUT} = 5V, V_{BAT} = 3.6V, L = 2.2 μH , C_{IN} = 47 μF , C_{OUT} = 68 μF , T_A = 25°C)

The device is not guaranteed to function outside its operating conditions. Parameters with MIN and/or MAX limits are 100% tested at +25°C, unless otherwise specified.

PARAMETER	SYMBOL	CONDITIONS	MIN	TYP	MAX	UNITS
General						
Input operation voltage	V _{BAT}		2.5	---	5	V
Output voltage	V _{OUT}	Line and Load Regulation in CCM (IL>100mA) V _{BAT} =2.5~4.5	4.925	5	5.075	V
Input Quiescent current	I _{BAT}	V _{BAT} = 3.6V FB=1.28 No load, no switching (exclude input current from ILM01)	---	50	70	μA
Shutdown supply current	I _{BAT}	(ILM01=0 in SOP-8)	---	0.1	1	μA
Oscillator&Protection						
Switching Frequency	F _{osc}		0.7	1.0	1.3	MHz
Soft-Start Interval	SS		4	5	6	ms
FB Regulation Voltage	V _{FB}		1.208	1.227	1.246	V
FB Input Current	I _{FB}	FB=1.0V	---	---	100	nA
T _{scp_restart}	Restart time in SCP		---	80	---	ms
short-Circuit Response Time	T _{short_response}	V _{OUT} < V _{OUT} X25%,	---	T _{osc}	---	μs
Current Limit Response Time	T _{oc_response}		---	T _{osc}	---	μs
Maximum Duty Cycle	D _{max}	FB=0.95V	86	93	96	%
DC-DC Switches						
V _{OUT} Leakage Current	I _{PVOUT_LK}	(ILM01=0 in SOP-8) V _{OUT} =5V	---	1	5	μA
LX Leakage Current	I _{LX_LK}	(ILM01=0 in SOP-8) V _{OUT} =5V	---	1	5	μA
Switch ON Resistance	R _{ON-N}		---	39	55	m Ω
	R _{ON-P}		---	42	60	
Peak Current Limit	I _{LIM}	ILM01=1	6.5	---	---	A
Efficiency		ILM01=1 V _{BAT} =3V, V _{OUT} =5V, I _{OUT} =2A	---	87	---	%

Electrical Characteristics (Continued)

PARAMETER	SYMBOL	CONDITIONS	MIN	TYP	MAX	UNITS
Protection Block						
VOUT Short-Circuit Threshold	V_{SCP}	Falling Edge	---	$V_{OUT}(1-0.27)$	---	V
VOUT Short-Circuit Threshold	V_{SCP}	Ring Edge	---	$V_{OUT}(1-0.19)$	---	V
VBAT UVLO Threshold	V_{UVLO}	Falling Edge	1.7	1.9	2.2	V
VBAT UVLO Threshold	V_{UVLO}	Rising Edge	2	2.2	2.5	V
Thermal Shutdown Threshold		Rising Edge, 20°C hysteresis	---	150	---	°C
Control Block						
ILM01 Input High Level	V_{ih_ilm}		1.5	---	5.5	V
ILM01 Input Low Level	V_{il_ilm}		0	---	0.5	V
ILIM01 Internal Pull-Low Resistance	R_{in_ilm}		200	250	300	K Ω

*note1: If ILM01 connect to Vbat, It will consume current $I_{ilm01} = V_{bat}/250k$

Typical performance Characteristics

($V_{IN}=2.5V\sim 4.2V$, $V_{OUT}=5V$, $C_{IN}=47\mu F$, $C_{OUT}=47\mu F + 22\mu F$, $L=2.2\mu H$, $T_A = 25^\circ C$)

V_{IN} , V_{OUT} , I_L Waveform

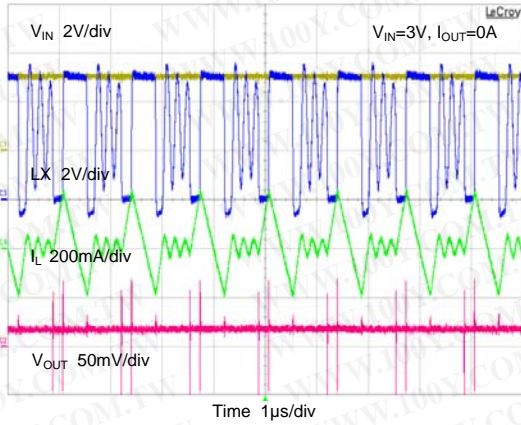

V_{IN} , V_{OUT} , I_L waveform

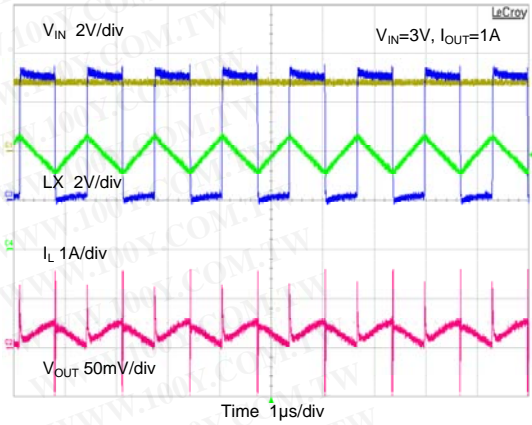

V_{IN} , V_{OUT} , I_L Waveform

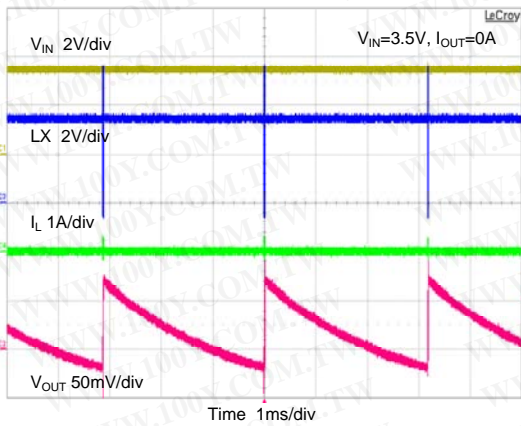

V_{IN} , V_{OUT} , I_L Waveform

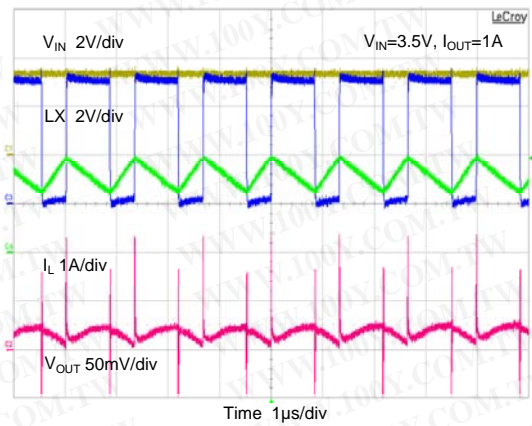

V_{IN} , V_{OUT} , I_L Waveform

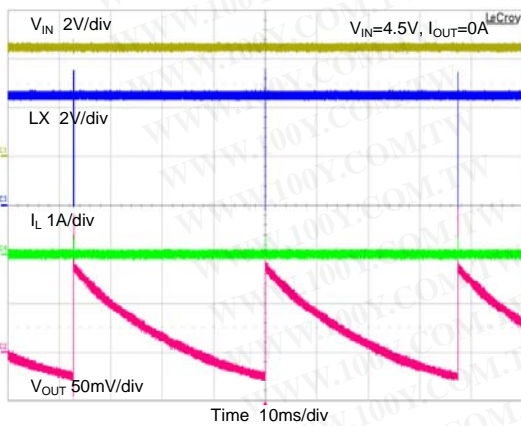

V_{IN} , V_{OUT} , I_L Waveform

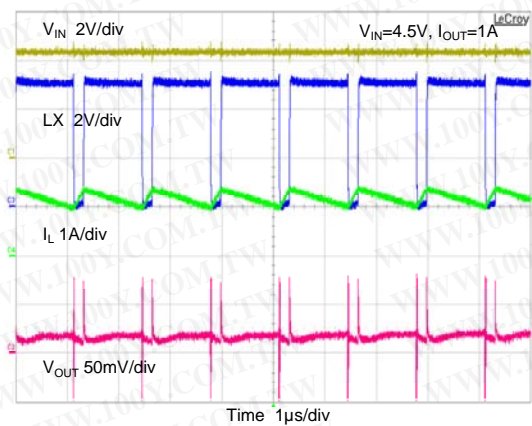

Typical Performance Characteristics (continued)

Start Up Waveform

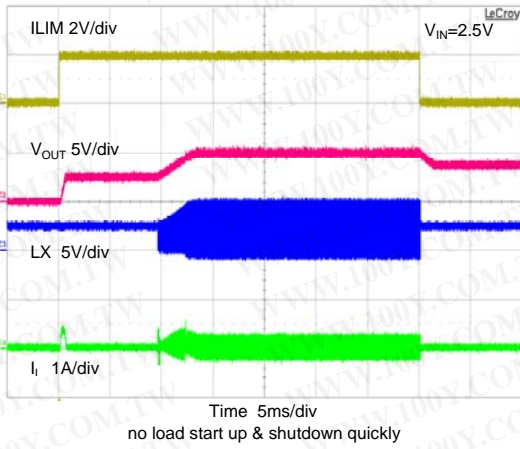

Start Up Waveform

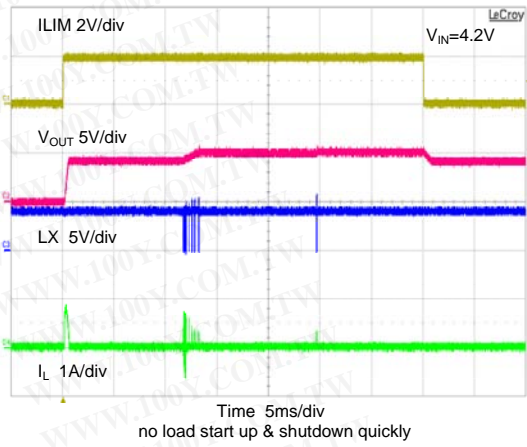

Start Up Waveform

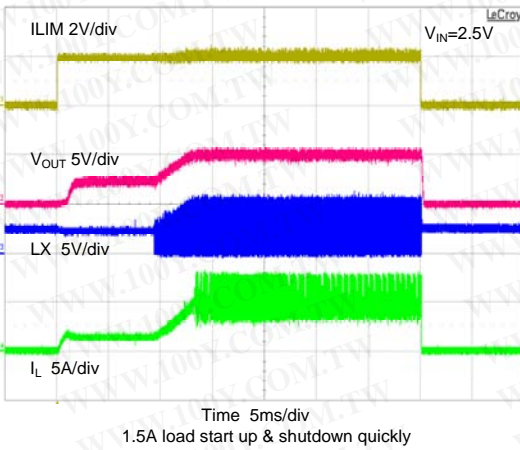

Start Up Waveform

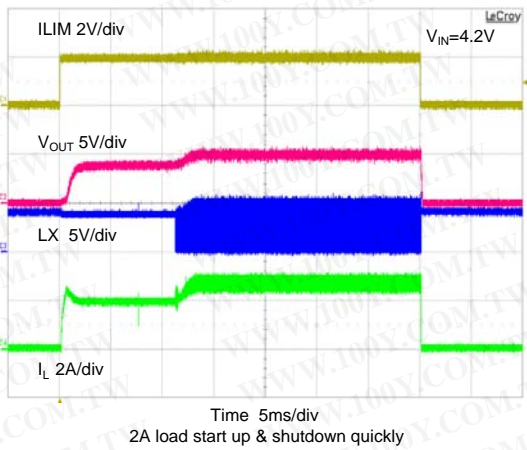

Short Circuit Waveform

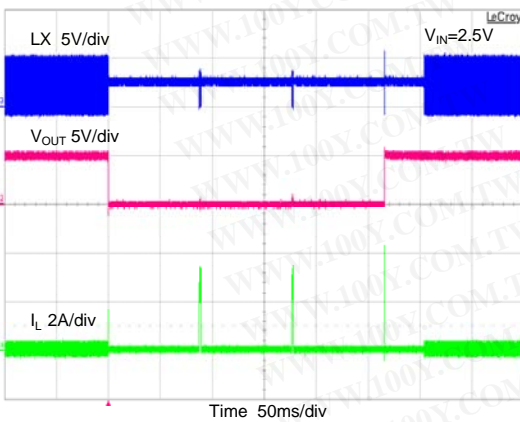

Short Circuit Waveform

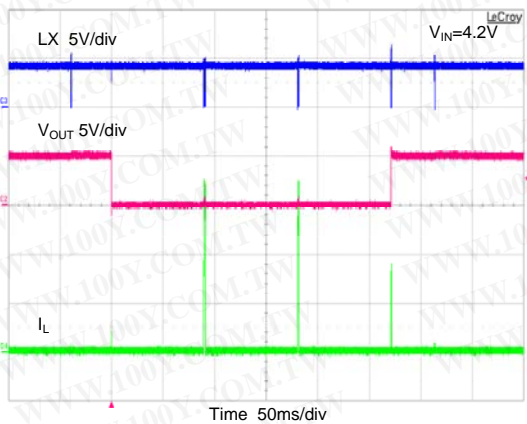

Typical Performance Characteristics (continued)

200mA ~ 1.5A Load Transient Waveform

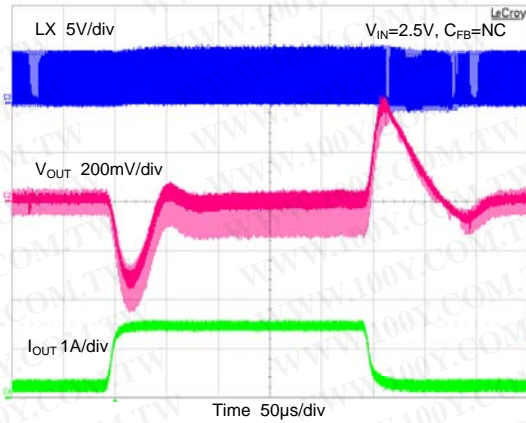

200mA ~ 1.5A Load Transient Waveform

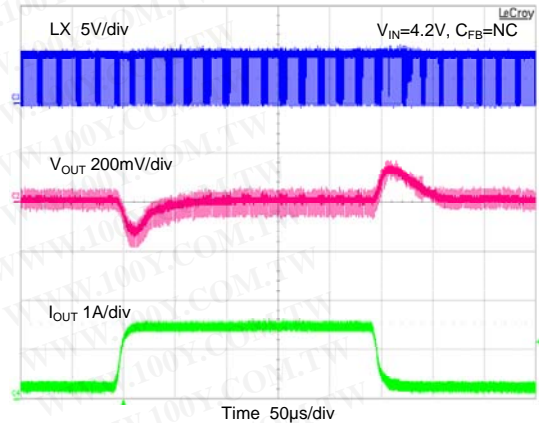

200mA ~ 1.5A Load Transient Waveform

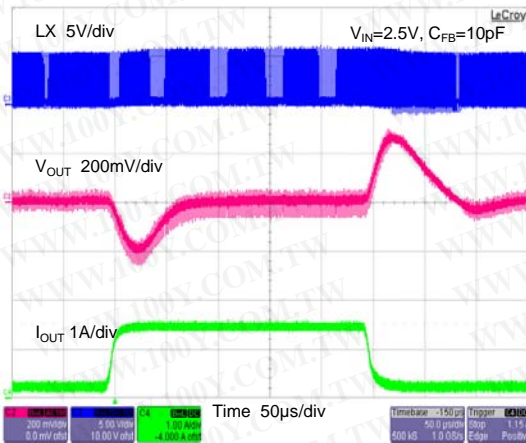

200mA ~ 1.5A Load Transient Waveform

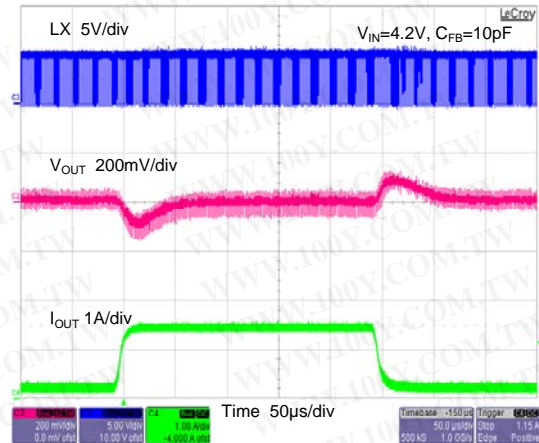

Over Current & Under Voltage Waveform

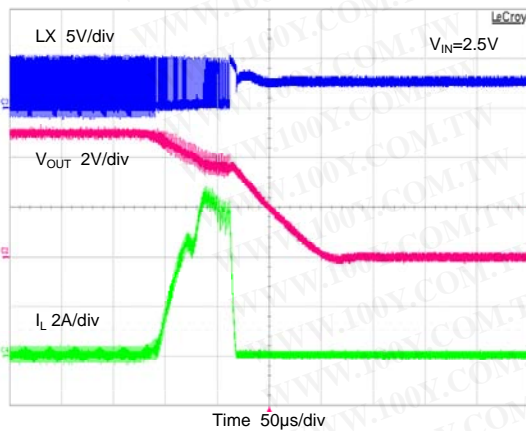

Over Current & Under Voltage Waveform

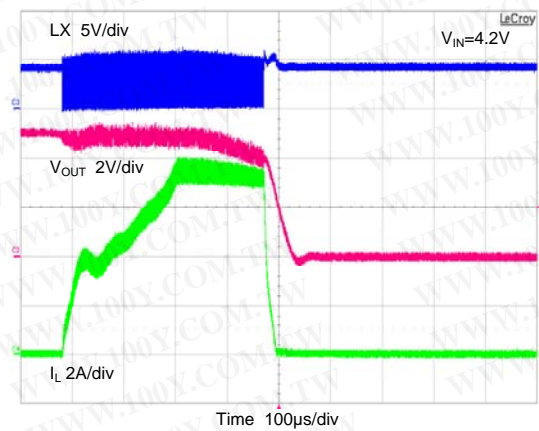

Typical Performance Characteristics (continued)

Efficiency VS. Load Current

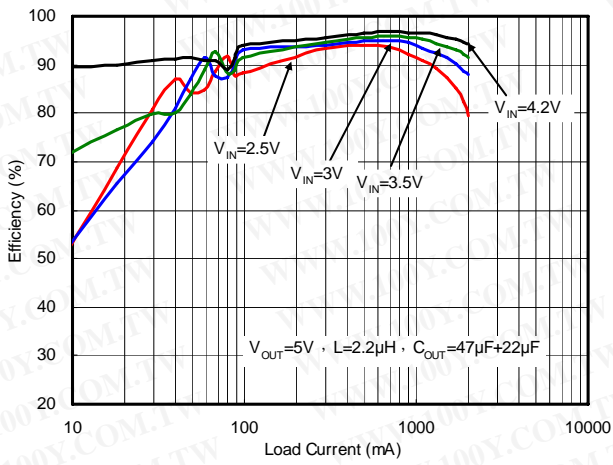

Switching Frequency VS. Load Current

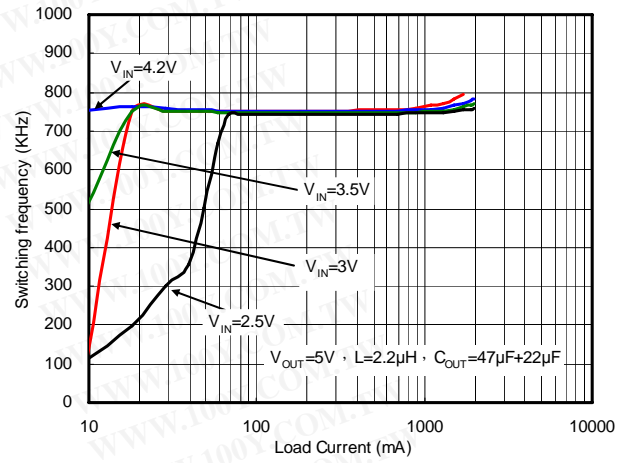

Minimum Footprint PCB Layout Section

SOP-8 (FD)

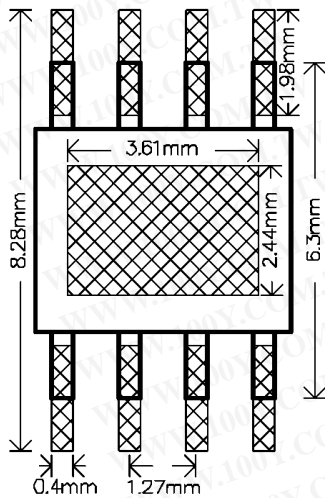

Pin Description For SOP-8 (FD)

PIN	NAME	FUNCTION
1,2	LX	Inductor Node.
3	VBAT	IC Power Supply Input.
4	ILIM01	Output Current Limit Setting, and On/Off Control.
5	GND	IC Analog Ground.
6	FB	Converter Feedback Input.
7,8	VOUT	Converter Output.
	EP	Exposed Paddle. Connect to the ground plane to optimize thermal performance. EP is internally connected to GND. EP must be connected to GND at a single point with a star ground connection.

Block Diagram (For SOP-8 (FD))

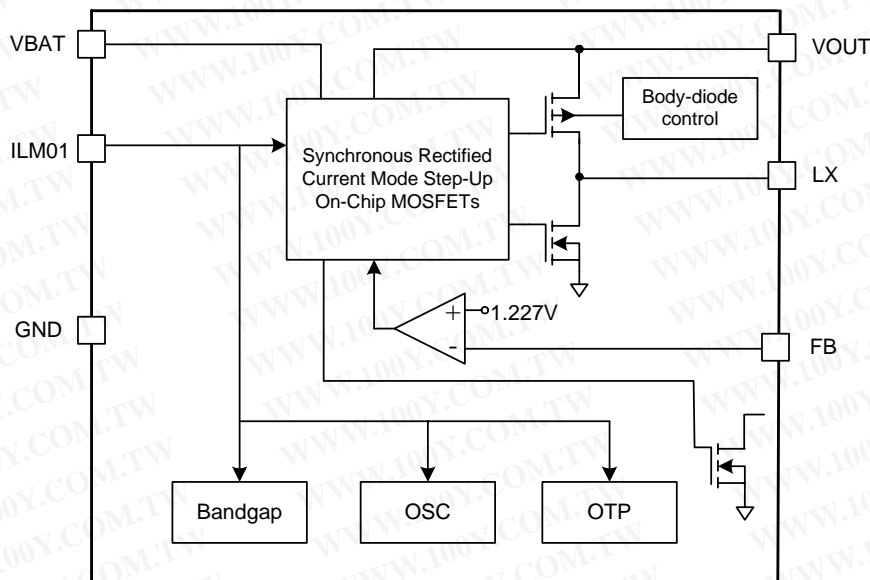

Function Description

The G5177B current-mode step-up DC-DC switching converter uses a fixed-frequency PWM architecture with output shutdown. In light-load mode, the converter switches when needed, consuming only 70µA of quiescent current. In heavy-load mode of higher than 100mA, the converter switches every cycle at a constant frequency as fixed-PWM, thus enabling noise filtering. The G5177B is highly efficient, with internal and synchronous switches. Shutdown reduces the quiescent current to less than 0.1µA. Low quiescent current and high efficiency make this device ideal for portable equipment.

The G5177B step-up DC-DC switching converter typically generates a 5V output voltage from a single-cell battery input voltage. The minimum output peak current limit is 6.5A in SOP8-FD package. When an

over-current, short-circuit or thermal shutdown condition is encountered. The converter will turn off until the over-current or over-temperature condition is removed, and during the state of short-circuit after precharge is end, the converter will turn off 64ms first and then turn on 1ms cycle by cycle to protect converter under short circuit operation. Internal soft-start limits the inrush current to less than 500mA under no-load conditions during startup. The G5177B is adjustable by 2 external resistors with calculating the value for R1 as $R1 = R2 (VOUT/VFB - 1)$.

The G5177B switches at a 1MHz frequency, allowing for tiny external components. The G5177B is optimized for use in iPad-like computers, smart phones, portable handheld devices and other applications requiring low quiescent current for maximum battery life.

Package Information

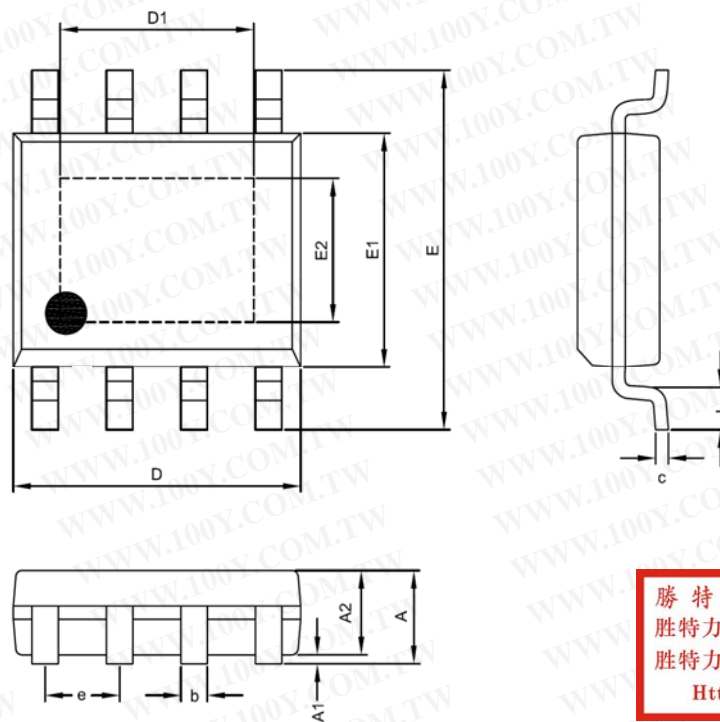

SOP- 8 (FD) Package

Symble	DIMENSION IN MM			DIMENSION IN INCH		
	MIN.	NOM.	MAX.	MIN.	NOM.	MAX.
A	1.35	1.55	1.65	0.053	0.061	0.065
A1	0.00	---	0.15	0.000	---	0.006
A2	1.15	1.35	1.50	0.045	0.053	0.059
D	4.80	4.90	5.00	0.189	0.192	0.197
D1	2.29	---	3.71	0.090	---	0.146
E	5.80	6.00	6.20	0.228	0.236	0.244
E1	3.80	3.90	4.00	0.150	0.153	0.157
E2	2.29	---	2.64	0.090	---	0.104
c	0.19	0.23	0.27	0.007	0.009	0.011
b	0.33	0.43	0.53	0.013	0.017	0.021
e	1.27 BSC			0.050 BSC		
L	0.40	0.70	1.00	0.016	0.028	0.039

Taping Specification

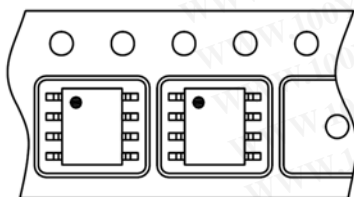

Feed Direction

PACKAGE	Q'TY/REEL
SOP-8 (FD)	2,500 ea

GMT Inc. does not assume any responsibility for use of any circuitry described, no circuit patent licenses are implied and GMT Inc. reserves the right at any time without notice to change said circuitry and specifications.

Ver: 0.1

Jul 31, 2013