



SOT23, Switched-Capacitor Voltage Inverters with Shutdown

General Description

The ultra-small MAX1719/MAX1720/MAX1721 monolithic, CMOS charge-pump inverters accept input voltages ranging from +1.5V to +5.5V. The MAX1720 operates at 12kHz, and the MAX1719/MAX1721 operate at 125kHz. High efficiency, small external components, and logic-controlled shutdown make these devices ideal for both battery-powered and board-level voltage conversion applications.

Oscillator control circuitry and four power MOSFET switches are included on-chip. A typical MAX1719/MAX1720/MAX1721 application is generating a -5V supply from a +5V logic supply to power analog circuitry. All three parts come in a 6-pin SOT23 package and can deliver a continuous 25mA output current.

For pin-compatible SOT23 switched-capacitor voltage inverters without shutdown (5-pin SOT23), see the MAX828/MAX829 and MAX870/MAX871 data sheets. For applications requiring more power, the MAX860/MAX861 deliver up to 50mA. For regulated outputs (up to $-2 \times V_{IN}$), refer to the MAX868. The MAX860/MAX861 and MAX868 are available in space-saving μ MAX packages.

Applications

- Local Negative Supply from a Positive Supply
- Small LCD Panels
- GaAs PA Bias Supply
- Handy-Terminals, PDAs
- Battery-Operated Equipment

Typical Operating Circuit

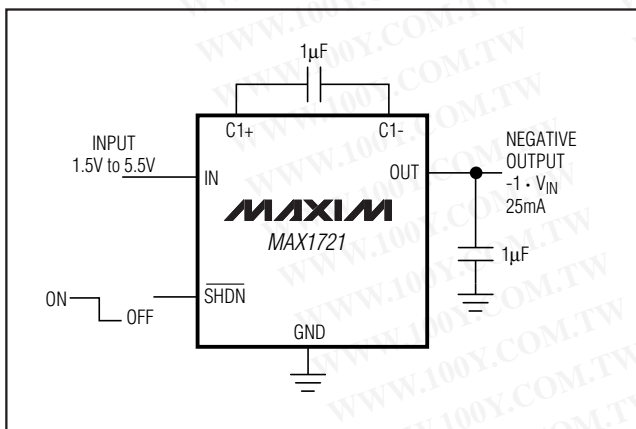

Features

- ◆ 1nA Logic-Controlled Shutdown
- ◆ 6-Pin SOT23 Package
- ◆ 99.9% Voltage Conversion Efficiency
- ◆ 50µA Quiescent Current (MAX1720)
- ◆ +1.5V to +5.5V Input Voltage Range
- ◆ 25mA Output Current
- ◆ Requires Only Two 1µF Capacitors (MAX1719/MAX1721)

Ordering Information

PART	TEMP RANGE	PIN-PACKAGE	SOT TOP MARK
MAX1719EUT	-40°C to +85°C	6 SOT23-6	AACA
MAX1720EUT	-40°C to +85°C	6 SOT23-6	AABS
MAX1721EUT	-40°C to +85°C	6 SOT23-6	AABT

Pin Configuration

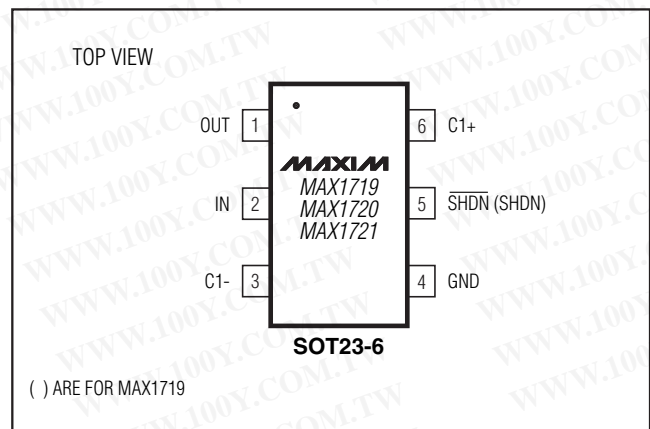

SOT23, Switched-Capacitor Voltage Inverters with Shutdown

ABSOLUTE MAXIMUM RATINGS

IN to GND	-0.3V to +6V
OUT to GND	-6V to +0.3V
C1+, SHDN, SHDN to GND	-0.3V to (V _{IN} + 0.3V)
C1- to GND	(V _{OUT} - 0.3V) to +0.3V
OUT Output Current	100mA
OUT Short Circuit to GND	Indefinite

Continuous Power Dissipation (T _A = +70°C)	6-Pin SOT23 (derate 8.7mW/°C above +70°C)	696mW
Operating Temperature Range		-40°C to +85°C
Junction Temperature		+150°C
Storage Temperature Range		-65°C to +150°C
Lead Temperature (soldering, 10s)		+300°C

Stresses beyond those listed under "Absolute Maximum Ratings" may cause permanent damage to the device. These are stress ratings only, and functional operation of the device at these or any other conditions beyond those indicated in the operational sections of the specifications is not implied. Exposure to absolute maximum rating conditions for extended periods may affect device reliability.

ELECTRICAL CHARACTERISTICS

(V_{IN} = +5V, SHDN = GND (MAX1719), $\overline{\text{SHDN}}$ = IN (MAX1720/MAX1721), C1 = C2 = 10μF (MAX1720), C1 = C2 = 1μF (MAX1719/MAX1721), circuit of Figure 1, T_A = 0°C to +85°C, unless otherwise noted. Typical values are at T_A = +25°C.)

PARAMETER	SYMBOL	CONDITIONS		MIN	TYP	MAX	UNITS
Supply Voltage Range	V _{IN}	MAX1720 R _L = 10kΩ	T _A = +25°C	1.25		5.5	V
			T _A = 0°C to +85°C	1.5		5.5	
		MAX1719/MAX1721 R _L = 10kΩ	T _A = +25°C	1.4		5.5	
			T _A = 0°C to +85°C	1.5		5.5	
Quiescent Supply Current (Note 3)	I _{CC}	T _A = +25°C	MAX1720		50	90	μA
			MAX1719/MAX1721		350	650	
Shutdown Supply Current	I _{SHDN}	SHDN = IN (MAX1719), $\overline{\text{SHDN}}$ = GND (MAX1720/MAX1721)	T _A = +25°C		0.001	1	μA
			T _A = +85°C		0.02		
Oscillator Frequency	f _{OSC}	T _A = +25°C	MAX1720	7	12	17	kHz
			MAX1719/MAX1721	70	125	180	
Voltage Conversion Efficiency		I _{OUT} = 0, T _A = +25°C		99	99.9		%
Output Resistance (Note 1)	R _O	I _{OUT} = 10mA	T _A = +25°C		23	50	Ω
			T _A = 0°C to +85°C			65	
OUT to GND Shutdown Resistance	R _{O, SHDN}	SHDN = IN (MAX1719), $\overline{\text{SHDN}}$ = GND (MAX1720/MAX1721), OUT is internally forced to GND in shutdown			4	12	Ω
SHDN/ $\overline{\text{SHDN}}$ Input Logic High	V _{IH}	+2.5V ≤ V _{IN} ≤ +5.5V		2.0			V
			V _{IN} (MIN) ≤ V _{IN} ≤ +2.5V		V _{IN} - 0.2		
SHDN/ $\overline{\text{SHDN}}$ Input Logic Low	V _{IL}	+2.5V ≤ V _{IN} ≤ +5.5V				0.6	V
			V _{IN} (MIN) ≤ V _{IN} ≤ +2.5V				
SHDN/ $\overline{\text{SHDN}}$ Bias Current	I _{IL} , I _{IH}	SHDN/ $\overline{\text{SHDN}}$ = GND or V _{IN}	T _A = +25°C	-100	0.05	100	nA
			T _A = +85°C			10	
Wake-Up Time from Shutdown		I _{OUT} = 5mA	MAX1720		800		μs
			MAX1719/MAX1721		80		

SOT23, Switched-Capacitor Voltage Inverters with Shutdown

MAX1719/MAX1720/MAX1721

ELECTRICAL CHARACTERISTICS

($V_{IN} = +5V$, SHDN = GND (MAX1719), $\overline{\text{SHDN}} = \text{IN}$ (MAX1720/MAX1721), $C_1 = C_2 = 10\mu\text{F}$ (MAX1720), $C_1 = C_2 = 1\mu\text{F}$ (MAX1719/MAX1721), circuit of Figure 1, $T_A = -40^\circ\text{C}$ to $+85^\circ\text{C}$, unless otherwise noted.) (Note 2)

PARAMETER	SYMBOL	CONDITIONS	MIN	TYP	MAX	UNITS
Supply Voltage Range	V_{IN}	$R_L = 10k\Omega$				
			MAX1720	1.5		5.5
Quiescent Current (Note 3)	I_{CC}					
			MAX1719/MAX1721	1.6		5.5
Oscillator Frequency	f_{OSC}					
			MAX1720	6		21
Voltage Conversion Efficiency						
			MAX1719/MAX1721	60		200
Voltage Conversion Efficiency		$I_{OUT} = 0$	99			%
Output Resistance (Note 1)	R_O	$I_{OUT} = 10\text{mA}$			65	Ω
Output Current	I_{OUT}	Continuous, long-term			25	mARMS
OUT to GND Shutdown Resistance	$R_{O, SHDN}$	SHDN = IN (MAX1719), $\overline{\text{SHDN}} = \text{GND}$ (MAX1720/MAX1721), OUT is internally forced to GND in shutdown			12	Ω
SHDN/ $\overline{\text{SHDN}}$ Input Logic High	V_{IH}	$+2.5V \leq V_{IN} \leq +5.5V$	2.1			V
		$V_{IN}(\text{MIN}) \leq V_{IN} \leq +2.5V$	$V_{IN} - 0.2$			V
SHDN/ $\overline{\text{SHDN}}$ Input Logic Low	V_{IL}	$+2.5V \leq V_{IN} \leq +5.5V$			0.6	V
		$V_{IN}(\text{MIN}) \leq V_{IN} \leq +2.5V$			0.2	V

Note 1: Capacitor contribution (ESR component plus $(1/f_{OSC}) \cdot C$) is approximately 20% of output impedance.

Note 2: All specifications from -40°C to $+85^\circ\text{C}$ are guaranteed by design, not production tested.

Note 3: The MAX1719/MAX1720/MAX1721 may draw high supply current during startup, up to the minimum operating supply voltage. To guarantee proper startup, the input supply must be capable of delivering 90mA more than the maximum load current.

Typical Operating Characteristics

(Circuit of Figure 1, $V_{IN} = +5V$, SHDN = GND (MAX1719), $\overline{\text{SHDN}} = \text{IN}$ (MAX1720/MAX1721), $C_1 = C_2 = C_3$, $T_A = +25^\circ\text{C}$, unless otherwise noted.)

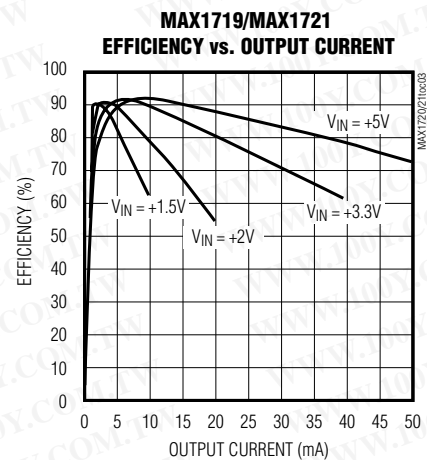
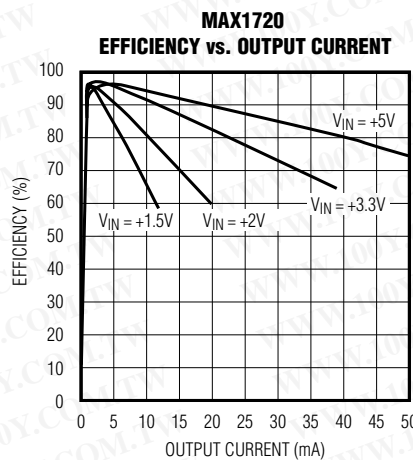
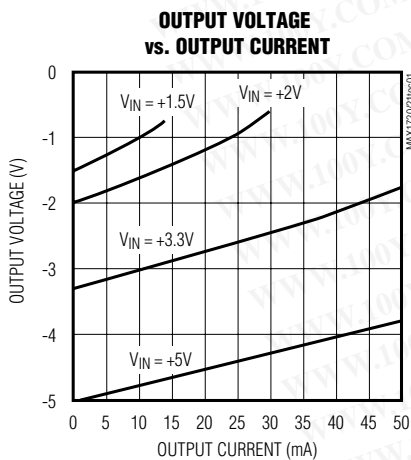

SOT23, Switched-Capacitor Voltage Inverters with Shutdown

Typical Operating Characteristics (continued)

(Circuit of Figure 1, $V_{IN} = +5V$, $SHDN = GND$ (MAX1719), $\overline{SHDN} = IN$ (MAX1720/MAX1721), $C1 = C2 = C3$, $T_A = +25^\circ C$, unless otherwise noted.)

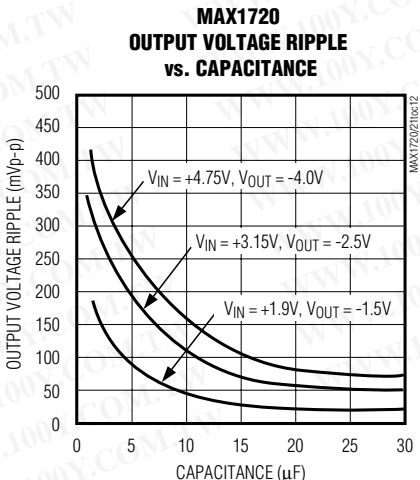
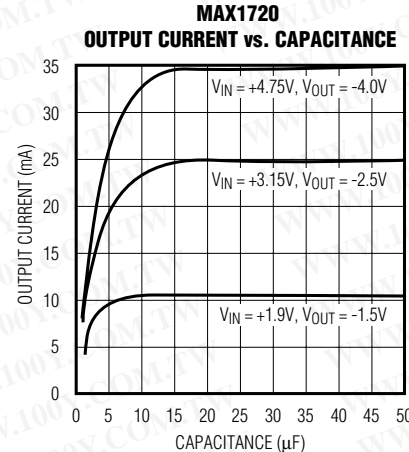
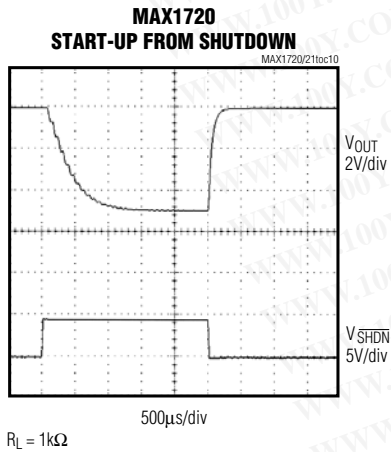
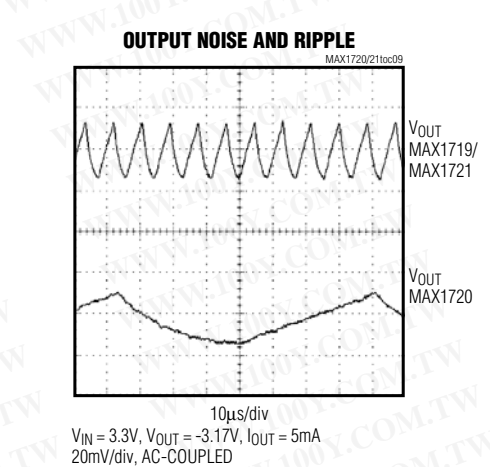
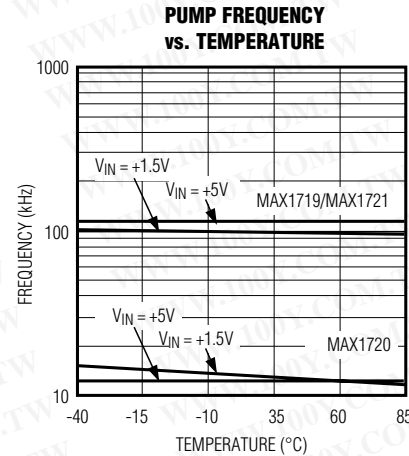
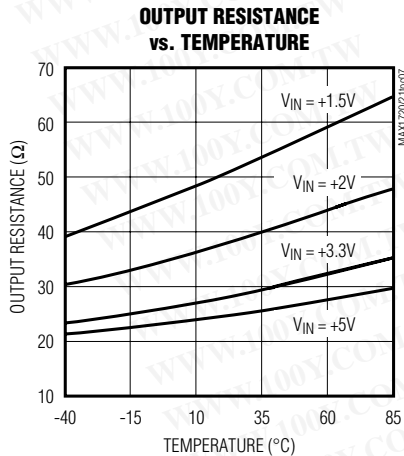
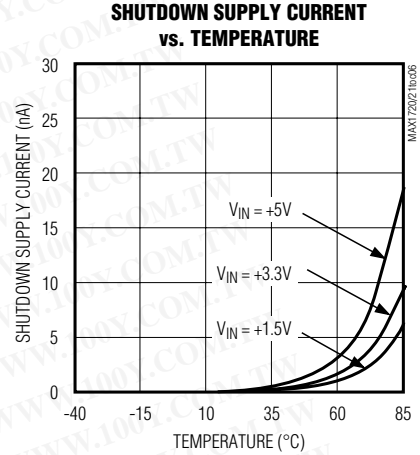
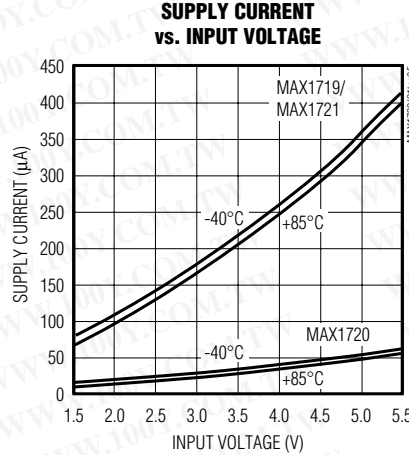
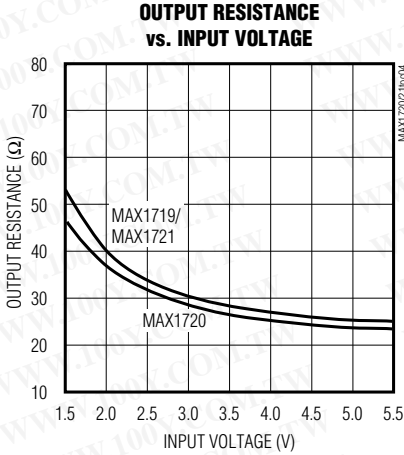

SOT23, Switched-Capacitor Voltage Inverters with Shutdown

Typical Operating Characteristics (continued)

(Circuit of Figure 1, $V_{IN} = +5V$, $SHDN = GND$ (MAX1719), $\overline{SHDN} = IN$ (MAX1720/MAX1721), $C1 = C2 = C3$, $T_A = +25^\circ C$, unless otherwise noted.)

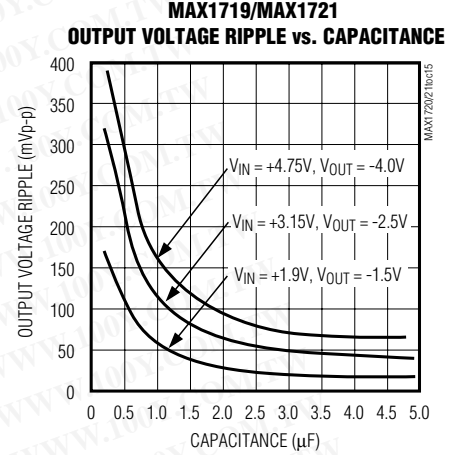
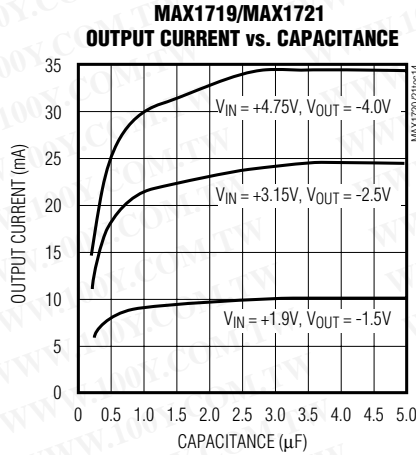
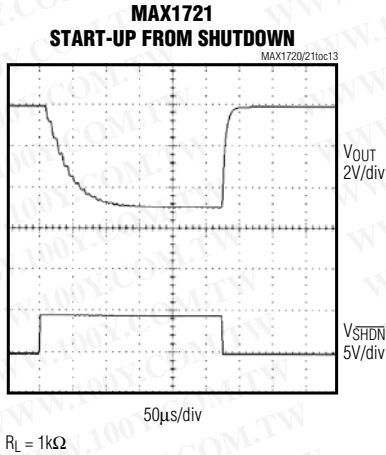

Pin Description

PIN		NAME	FUNCTION
MAX1719	MAX1720 MAX1721		
1	1	OUT	Inverting Charge-Pump Output
2	2	IN	Power-Supply Positive Voltage Input
3	3	C1-	Negative Terminal of Flying Capacitor
4	4	GND	Ground
5	-	SHDN	Noninverting Shutdown Input. Drive this pin low for normal operation; drive it high for shutdown mode. OUT is actively pulled to ground during shutdown.
-	5	\overline{SHDN}	Inverting Shutdown Input. Drive this pin high for normal operation; drive it low for shutdown mode. OUT is actively pulled to ground during shutdown.
6	6	C1+	Positive Terminal of Flying Capacitor

Detailed Description

The MAX1719/MAX1720/MAX1721 capacitive charge pumps invert the voltage applied to their input. For highest performance, use low equivalent series resistance (ESR) capacitors (e.g., ceramic).

During the first half-cycle, switches S2 and S4 open, switches S1 and S3 close, and capacitor C1 charges to the voltage at IN (Figure 2). During the second half-

cycle, S1 and S3 open, S2 and S4 close, and C1 is level shifted downward by V_{IN} volts. This connects C1 in parallel with the reservoir capacitor C2. If the voltage across C2 is smaller than the voltage across C1, charge flows from C1 to C2 until the voltage across C2 reaches $-V_{IN}$. The actual voltage at the output is more positive than $-V_{IN}$, since switches S1–S4 have resistance and the load drains charge from C2.

SOT23, Switched-Capacitor Voltage Inverters with Shutdown

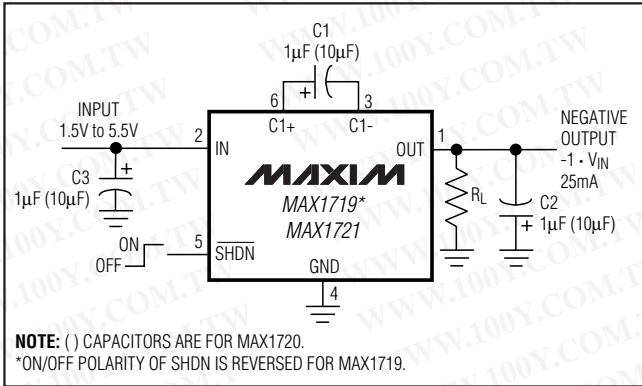

Figure 1. Typical Application Circuit

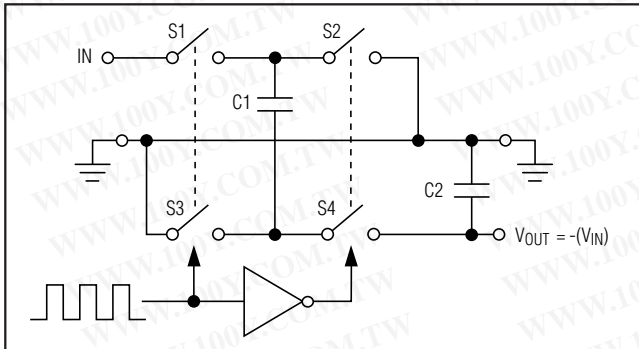

Figure 2. Ideal Voltage Inverter

Charge-Pump Output

The MAX1719/MAX1720/MAX1721 are not voltage regulators: the charge pumps' output resistance is approximately 23Ω at room temperature (with $V_{IN} = +5V$), and V_{OUT} approaches -5V when lightly loaded. V_{OUT} will droop toward GND as load current increases. The droop of the negative supply (V_{DROOP-}) equals the current draw from OUT (I_{OUT}) times the negative converter's output resistance (R_O):

$$V_{DROOP-} = I_{OUT} \times R_O$$

The negative output voltage will be:

$$V_{OUT} = -(V_{IN} - V_{DROOP-})$$

Efficiency Considerations

The efficiency of the MAX1719/MAX1720/MAX1721 is dominated by its quiescent supply current (I_Q) at low output current and by its output impedance (R_{OUT}) at higher output current; it is given by:

$$\eta \cong \frac{I_{OUT}}{I_{OUT} + I_Q} \left(1 - \frac{I_{OUT} \times R_{OUT}}{V_{IN}} \right)$$

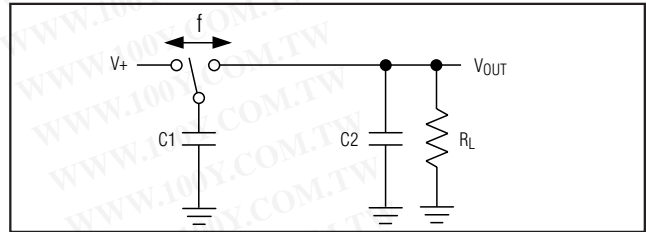

Figure 3a. Switched-Capacitor Model

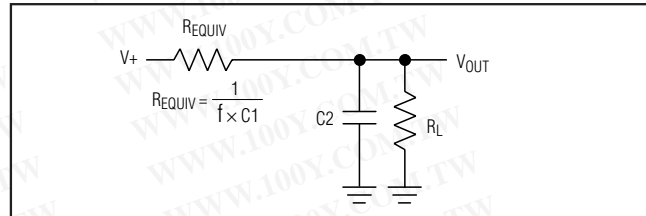

Figure 3b. Equivalent Circuit

where the output impedance is roughly approximated by:

$$R_{OUT} \cong \frac{1}{(f_{OSC}) \times C1} + 2R_{SW} + 4ESR_{C1} + ESR_{C2}$$

The first term is the effective resistance of an ideal switched-capacitor circuit (Figures 3a and 3b), and R_{SW} is the sum of the charge pump's internal switch resistances (typically 8Ω to 9Ω at $V_{IN} = +5V$). The typical output impedance is more accurately determined from the *Typical Operating Characteristics*.

Shutdown Mode

The MAX1719/MAX1720/MAX1721 have a logic-controlled shutdown input. Driving SHDN low places the MAX1720/MAX1721 in a low-power shutdown mode. The MAX1719's shutdown input is inverted from that of the MAX1720/MAX1721. Driving SHDN high places the MAX1719 in a low-power shutdown mode. The charge-pump switching halts, supply current is reduced to 1nA, and OUT is actively pulled to ground through a 4Ω resistance.

Applications Information

Capacitor Selection

To maintain the lowest output resistance, use capacitors with low ESR (Table 1). The charge-pump output resistance is a function of C1's and C2's ESR. Therefore, minimizing the charge-pump capacitor's ESR minimizes the total output resistance. Table 2 gives suggested capacitor values for minimizing output resistance or minimizing capacitor size.

SOT23, Switched-Capacitor Voltage Inverters with Shutdown

Flying Capacitor (C1)

Increasing the flying capacitor's value reduces the output resistance. Above a certain point, increasing C1's capacitance has a negligible effect because the output resistance becomes dominated by the internal switch resistance and capacitor ESR.

Output Capacitor (C2)

Increasing the output capacitor's value reduces the output ripple voltage. Decreasing its ESR reduces both output resistance and ripple. Lower capacitance values can be used with light loads if higher output ripple can be tolerated. Use the following equation to calculate the peak-to-peak ripple:

$$V_{\text{RIPPLE}} = \frac{I_{\text{OUT}}}{2 \times f_{\text{OSC}} \times C2} + 2 \times I_{\text{OUT}} \times \text{ESR}_{C2}$$

Input Bypass Capacitor (C3)

Bypass the incoming supply to reduce its AC impedance and the impact of the MAX1719/MAX1720/MAX1721's switching noise. A bypass capacitor with a value equal to that of C1 is recommended.

Voltage Inverter

The most common application for these devices is a charge-pump voltage inverter (Figure 1). This application requires only two external components—capacitors C1 and C2—plus a bypass capacitor, if necessary. Refer to the *Capacitor Selection* section for suggested capacitor types.

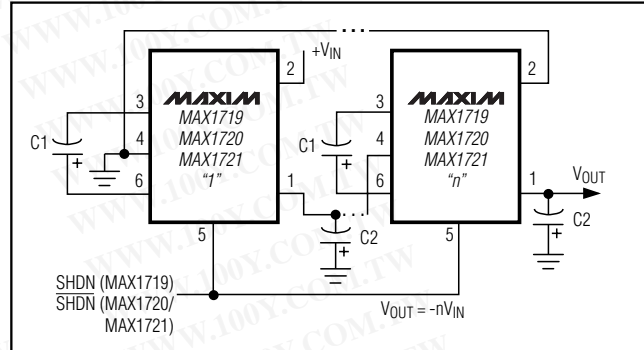

Figure 4. Cascading MAX1719s or MAX1720s or MAX1721s to Increase Output Voltage

Cascading Devices

Two devices can be cascaded to produce an even larger negative voltage (Figure 4). The unloaded output voltage is normally $-2 \times V_{\text{IN}}$, but this is reduced slightly by the output resistance of the first device multiplied by the quiescent current of the second. When cascading more than two devices, the output resistance rises dramatically. For applications requiring larger negative voltages, see the MAX865 and MAX868 data sheets. The maximum load current and startup current of the n^{th} cascaded circuit must not exceed the maximum output current capability of the $(n - 1)^{\text{th}}$ circuit to ensure proper startup.

Table 1. Low-ESR Capacitor Manufacturers

PRODUCTION METHOD	MANUFACTURER	SERIES	PHONE	FAX
Surface-Mount Tantalum	AVX	TPS series	803-946-0690	803-626-3123
	Matsuo	267 series	714-969-2491	714-960-6492
	Sprague	593D, 595D series	603-224-1961	603-224-1430
Surface-Mount Ceramic	AVX	X7R	803-946-0690	803-626-3123
	Matsuo	X7R	714-969-2491	714-960-6492

Table 2. Capacitor Selection for Minimum Output Resistance or Capacitor Size

PART	fosc	CAPACITORS TO MINIMIZE OUTPUT RESISTANCE (Ro = 23Ω, TYP) C1 = C2	CAPACITORS TO MINIMIZE SIZE (Ro = 40Ω, TYP) C1 = C2
MAX1720	12kHz	10μF	3.3μF
MAX1719/MAX1721	125kHz	1μF	0.33μF

SOT23, Switched-Capacitor Voltage Inverters with Shutdown

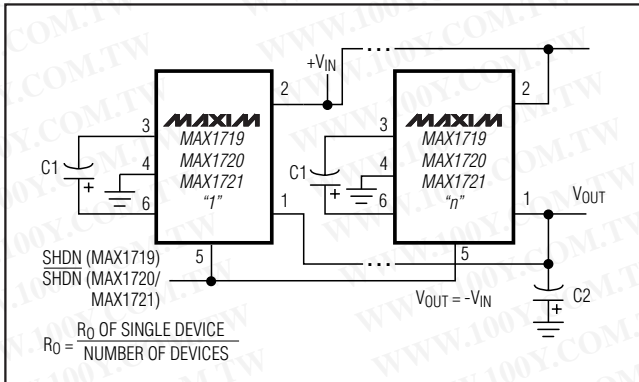

Figure 5. Paralleling MAX1719s or MAX1720s or MAX1721s to Reduce Output Resistance

Paralleling Devices

Paralleling multiple MAX1719s, MAX1720s, or MAX1721s reduces the output resistance. Each device requires its own pump capacitor (C1), but the reservoir capacitor (C2) serves all devices (Figure 5). Increase C2's value by a factor of n, where n is the number of parallel devices. Figure 5 shows the equation for calculating output resistance.

Combined Doubler/Inverter

In the circuit of Figure 6, capacitors C1 and C2 form the inverter, while C3 and C4 form the doubler. C1 and C3 are the pump capacitors; C2 and C4 are the reservoir capacitors. Because both the inverter and doubler use part of the charge-pump circuit, loading either output causes both outputs to decline toward GND. Make sure the sum of the currents drawn from the two outputs does not exceed 25mA.

Heavy Load Connected to a Positive Supply

Under heavy loads, where a higher supply is sourcing current into OUT, the OUT supply must not be pulled above ground. Applications that sink heavy current into

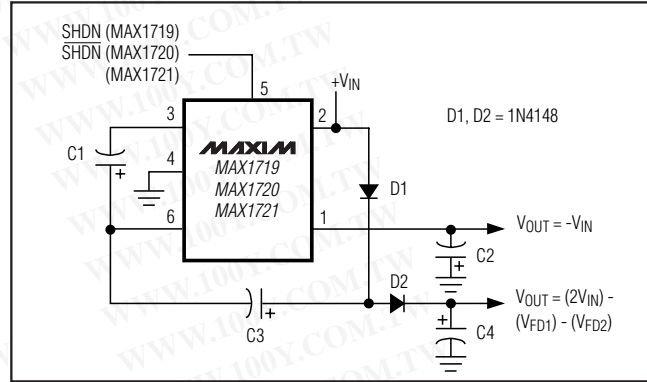

Figure 6. Combined Doubler and Inverter

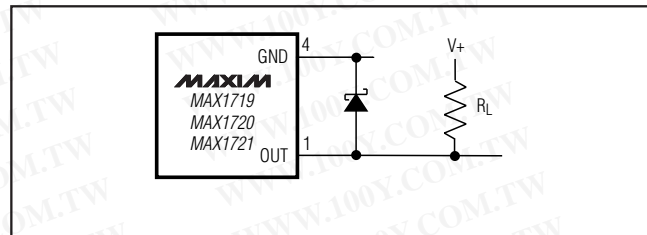

Figure 7. Heavy Load Connected to a Positive Supply

OUT require a Schottky diode (1N5817) between GND and OUT, with the anode connected to OUT (Figure 7).

Layout and Grounding

Good layout is important, primarily for good noise performance. To ensure good layout, mount all components as close together as possible, keep traces short to minimize parasitic inductance and capacitance, and use a ground plane.

Chip Information

TRANSISTOR COUNT: 85

勝特力材料 886-3-5753170
 勝特力电子(上海) 86-21-34970699
 勝特力电子(深圳) 86-755-83298787
[Http://www.100y.com.tw](http://www.100y.com.tw)

Maxim cannot assume responsibility for use of any circuitry other than circuitry entirely embodied in a Maxim product. No circuit patent licenses are implied. Maxim reserves the right to change the circuitry and specifications without notice at any time.

8 Maxim Integrated Products, 120 San Gabriel Drive, Sunnyvale, CA 94086 408-737-7600