

EVALUATION KIT  
 AVAILABLE

# MAXIM

## 3.3V/5V or Adjustable-Output, Step-Up DC-DC Converters

### General Description

The MAX856–MAX859 are high-efficiency, CMOS, step-up, DC-DC switching regulators for small, low input voltage or battery-powered systems. The MAX856/MAX858 accept a positive input voltage between 0.8V and  $V_{OUT}$  and convert it to a higher, pin-selectable output voltage of 3.3V or 5V. The MAX857/MAX859 adjustable versions accept 0.8V to 6.0V input voltages and generate higher adjustable output voltages in the 2.7V to 6.0V range. Typical efficiencies are greater than 85%. Typical quiescent supply current is 25 $\mu$ A (1 $\mu$ A in shutdown).

The MAX856–MAX859 combine ultra-low quiescent supply current and high efficiency to give maximum battery life. An internal MOSFET power transistor permits high switching frequencies. This benefit, combined with internally set peak inductor current limits, permits the use of small, low-cost inductors. The MAX856/MAX857 have a 500mA peak inductor current limit. The MAX858/MAX859 have a 125mA peak inductor current limit.

### Applications

3.3V to 5V Step-Up Conversion  
 Palmtop Computers  
 Portable Data-Collection Equipment  
 Personal Data Communicators/Computers  
 Medical Instrumentation  
 2-Cell & 3-Cell Battery-Operated Equipment  
 Glucose Meters

### Typical Operating Circuit

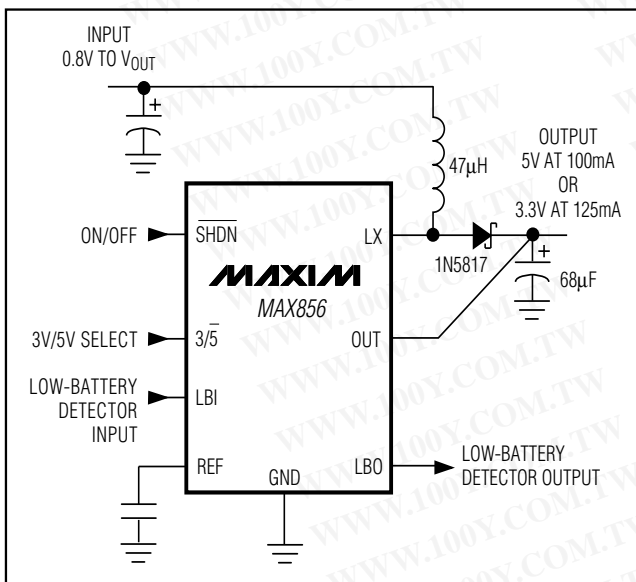

### Features

- ◆ 0.8V to 6.0V Input Supply Voltage
- ◆ 0.8V Typ Start-Up Supply Voltage
- ◆ 85% Efficiency at 100mA
- ◆ 25 $\mu$ A Quiescent Current
- ◆ 1 $\mu$ A Shutdown Mode
- ◆ 125mA and 500mA Switch-Current Limits Permit Use of Low-Cost Inductors
- ◆ Up to 500kHz Switching Frequency
- ◆  $\pm 1.5\%$  Reference Tolerance Over Temperature
- ◆ Low-Battery Detector (LBI/LBO)
- ◆ 8-Pin SO and  $\mu$ MAX Packages

### Ordering Information

PART	TEMP. RANGE	PIN-PACKAGE
MAX856CSA	0°C to +70°C	8 SO
MAX856CUA	0°C to +70°C	8 $\mu$ MAX
MAX856C/D	0°C to +70°C	Dice*
MAX856ESA	-40°C to +85°C	8 SO
MAX856MJA	-55°C to +125°C	8 CERDIP†
MAX857CSA	0°C to +70°C	8 SO
MAX857CUA	0°C to +70°C	8 $\mu$ MAX
MAX857C/D	0°C to +70°C	Dice*
MAX857ESA	-40°C to +85°C	8 SO
MAX857MJA	-55°C to +125°C	8 CERDIP†

Ordering Information continued at end of data sheet.

\* Dice are tested at  $T_A = +25^\circ\text{C}$  only.

† Contact factory for availability.

### Pin Configuration

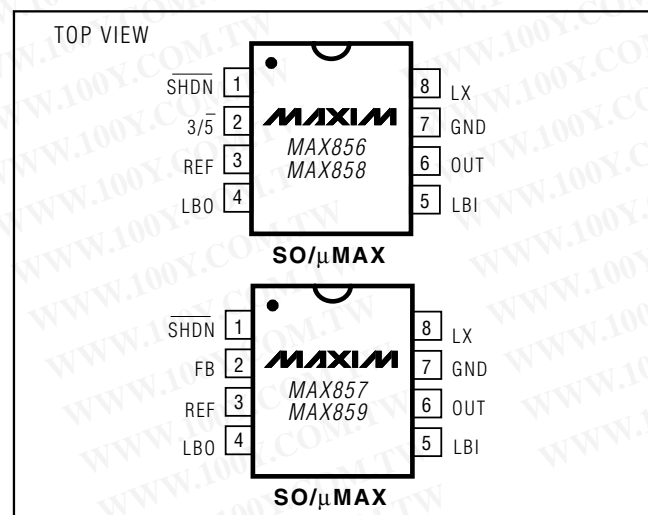

MAXIM

Maxim Integrated Products 1

For free samples & the latest literature: <http://www.maxim-ic.com>, or phone 1-800-998-8800

MAX856–MAX859

## 3.3V/5V or Adjustable-Output, Step-Up DC-DC Converters

### ABSOLUTE MAXIMUM RATINGS

Supply Voltage (OUT to GND)	-0.3V, +7V
Switch Voltage (LX to GND)	-0.3V, +7V
SFDN, LBO to GND	-0.3V, +7V
LBI, REF, 3/5, FB to GND	-0.3V, (V <sub>OUT</sub> + 0.3V)
Reference Current (I <sub>REF</sub> )	2.5mA
Continuous Power Dissipation (T <sub>A</sub> = +70°C)	
SO (derate 5.88mW/°C above +70°C)	471mW
μMAX (derate 4.1mW/°C above +70°C)	330mW
CERDIP (derate 8.00mW/°C above +70°C)	640mW

Reverse Battery Current (T <sub>A</sub> ≤ +45°C, Note 1)	750mA
Operating Temperature Ranges	
MAX85_C_	0°C to +70°C
MAX85_E_	-40°C to +85°C
MAX85_MJA	-55°C to +125°C
Junction Temperature	+150°C
Storage Temperature Range	-65°C to +160°C
Lead Temperature (soldering, 10sec)	+300°C

**Note 1:** Reverse battery current is measured from the *Typical Operating Circuit's* battery input terminal to GND when the battery is connected backwards. A reverse current of 750mA will not exceed the SO or CERDIP package dissipation limits but, if left for an extended time (more than ten minutes), may degrade performance.

Stresses beyond those listed under "Absolute Maximum Ratings" may cause permanent damage to the device. These are stress ratings only, and functional operation of the device at these or any other conditions beyond those indicated in the operational sections of the specifications is not implied. Exposure to absolute maximum rating conditions for extended periods may affect device reliability.

### ELECTRICAL CHARACTERISTICS

(Circuits of Figure 2, V<sub>IN</sub> = 2.5V, I<sub>LOAD</sub> = 0mA, T<sub>A</sub> = T<sub>MIN</sub> to T<sub>MAX</sub>, unless otherwise noted. Typical values are at T<sub>A</sub> = +25°C.)

PARAMETER	CONDITIONS		MIN	TYP	MAX	UNITS
Output Voltage	2V ≤ V <sub>IN</sub> ≤ 3V	MAX856, 3/5 = 0V, 0mA ≤ I <sub>LOAD</sub> ≤ 100mA	4.80	5.0	5.20	V
		MAX856, 3/5 = 3V, 0mA ≤ I <sub>LOAD</sub> ≤ 150mA	3.17	3.3	3.43	
		MAX857, V <sub>OUT</sub> = 5V, 0mA ≤ I <sub>LOAD</sub> ≤ 100mA	4.80	5.0	5.20	
		MAX858, 3/5 = 0V, 0mA ≤ I <sub>LOAD</sub> ≤ 25mA	4.80	5.0	5.20	
		MAX858, 3/5 = 3V, 0mA ≤ I <sub>LOAD</sub> ≤ 35mA	3.17	3.3	3.43	
		MAX859, V <sub>OUT</sub> = 5V, 0mA ≤ I <sub>LOAD</sub> ≤ 25mA	4.80	5.0	5.20	
Minimum Start-Up Supply Voltage	I <sub>LOAD</sub> = 0mA			0.8	1.8	V
Minimum Operating Voltage				0.8		V
Quiescent Supply Current in 3.3V Mode (Note 2)	I <sub>LOAD</sub> = 0mA, 3/5 = 3V, LBI = 1.5V, V <sub>OUT</sub> = 3.47V, (FB = 1.5V, MAX857/MAX859 only)			25	60	μA
No Load Battery Current	Output set for 3.3V, measured at V <sub>IN</sub> in Figure 2, R3 omitted.			60		μA
Shutdown Quiescent Current (Note 2)	SFDN = 0V, 3/5 = 3V, LBI = 1.5V, V <sub>OUT</sub> = 3.47V, (FB = 1.5V, MAX857/MAX859 only)	MAX85_C			1	μA
		MAX85_E/M		1	5	
Peak Inductor Current Limit	MAX856/MAX857			500		mA
	MAX858/MAX859			125		
Reference Voltage	No REF load		1.23	1.25	1.27	V
Reference-Voltage Regulation	3/5 = 3V, -20μA ≤ REF load ≤ 250μA, C <sub>REF</sub> = 0.22μF			0.8	2.0	%
LBI Input Threshold	With falling edge		1.22	1.25	1.28	V
LBI Input Hysteresis				25		mV
LBO Output Voltage Low	I <sub>SINK</sub> = 2mA				0.4	V
LBO Output Leakage Current	LBO = 5V				1	μA

# 3.3V/5V or Adjustable-Output, Step-Up DC-DC Converters

## ELECTRICAL CHARACTERISTICS (continued)

(Circuits of Figure 2,  $V_{IN} = 2.5V$ ,  $I_{LOAD} = 0mA$ ,  $T_A = T_{MIN}$  to  $T_{MAX}$ , unless otherwise noted. Typical values are at  $T_A = +25^{\circ}C$ .)

SHDN, 3/5 Input Voltage Low		0.4	V
SHDN, 3/5 Input Voltage High		1.6	V
SHDN, 3/5, FB, LBI Input Current	LBI = 1.5V, FB = 1.5V, SHDN = 0V or 3V, 3/5 = 0V or 3V	$\pm 100$	nA
FB Voltage	MAX857/MAX859	1.22    1.25    1.28	V
Output Voltage Range	MAX857/MAX859, $I_{LOAD} = 0mA$ (Note 3)	2.7    6.0	V

**Note 2:** Supply current from the 3.3V output is measured with an ammeter between the 3.3V output and OUT pin. This current correlates directly with actual battery supply current, but is reduced in value according to the step-up ratio and efficiency.  $V_{OUT} = 3.47V$  to keep the internal switch open when measuring the current into the device.

**Note 3:** Minimum value is production tested. Maximum value is guaranteed by design and is not production tested.

## Typical Operating Characteristics

(Circuits of Figure 2,  $T_A = +25^{\circ}C$ , unless otherwise noted.)

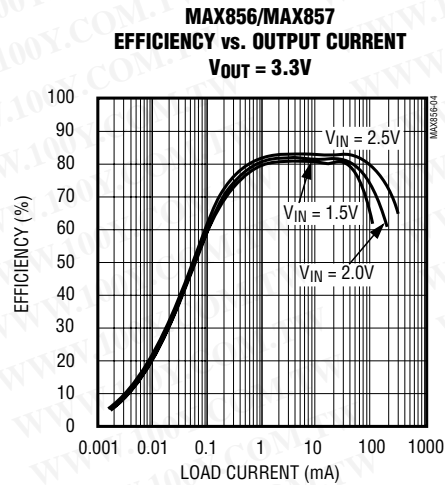
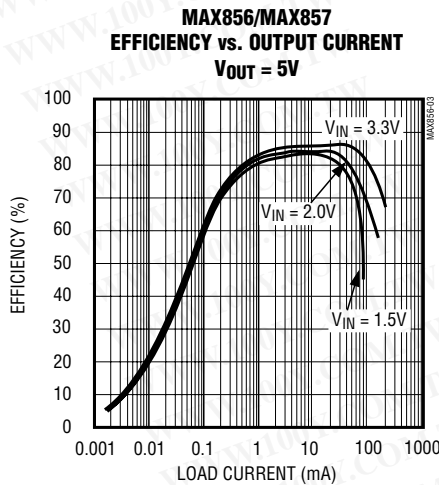
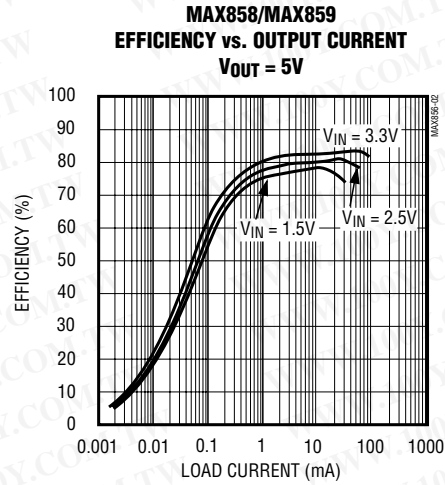
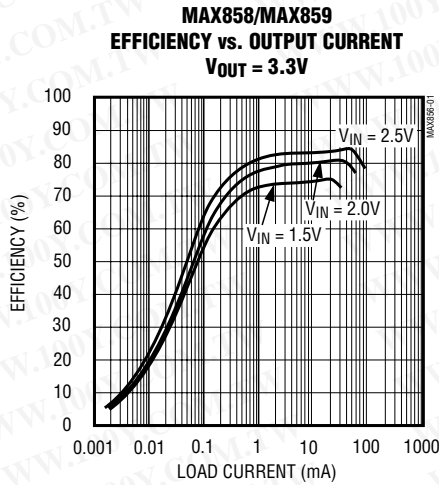

# 3.3V/5V or Adjustable-Output, Step-Up DC-DC Converters

## Typical Operating Characteristics (continued)

(Circuits of Figure 2,  $T_A = +25^\circ\text{C}$ , unless otherwise noted.)

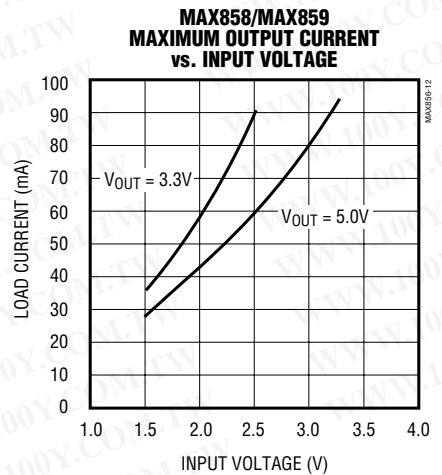
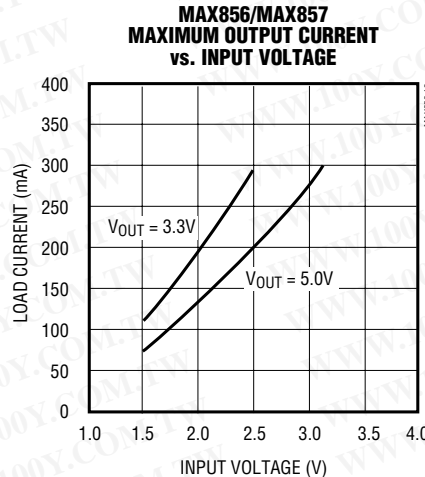
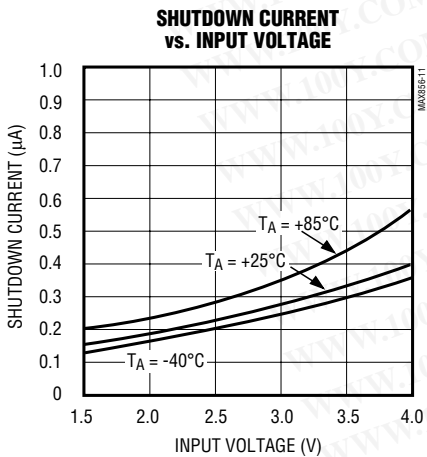
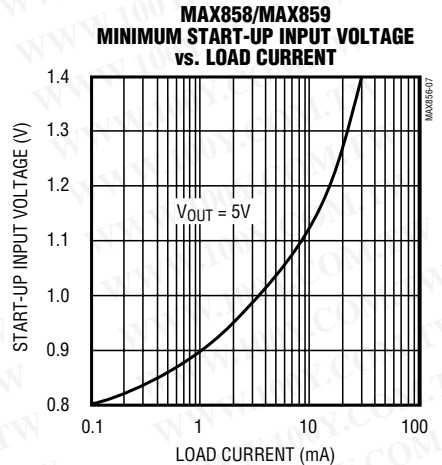
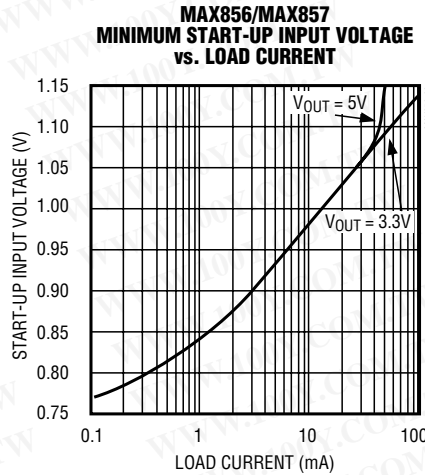
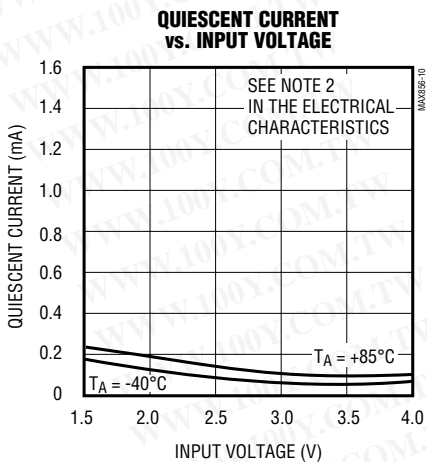
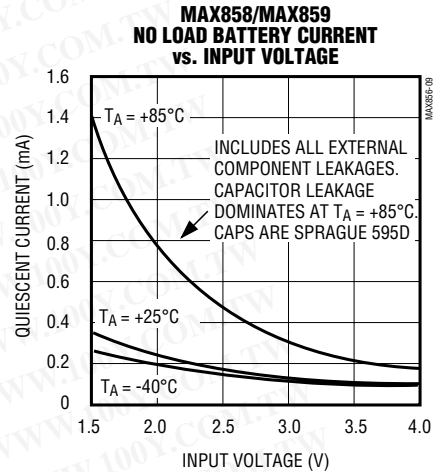
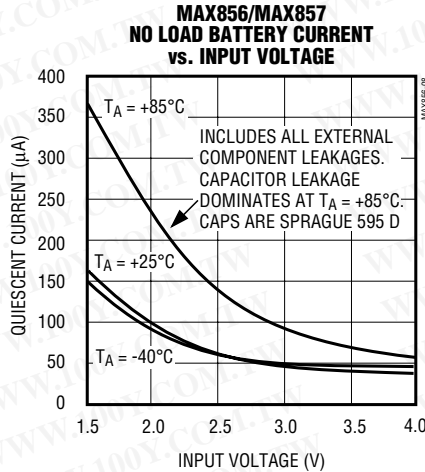
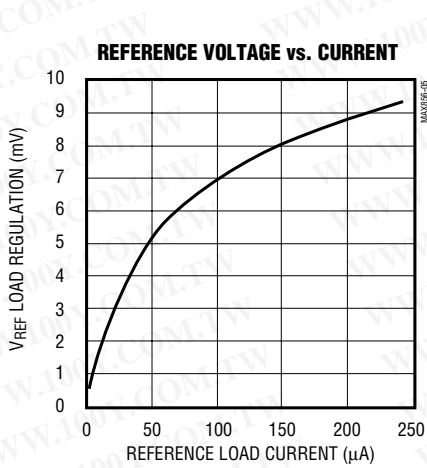

# 3.3V/5V or Adjustable-Output, Step-Up DC-DC Converters

MAX8556-MAX8559

## Typical Operating Characteristics (continued)

(Circuits of Figure 2,  $T_A = +25^\circ\text{C}$ , unless otherwise noted.)

**MAX856/MAX857  
LINE-TRANSIENT RESPONSE (5V MODE)**

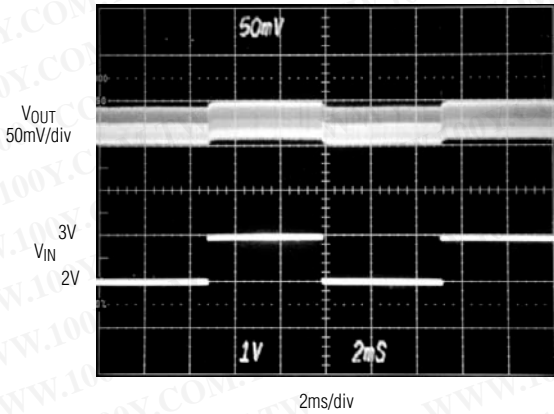

**MAX856/MAX857  
LOAD-TRANSIENT RESPONSE (5V MODE)**

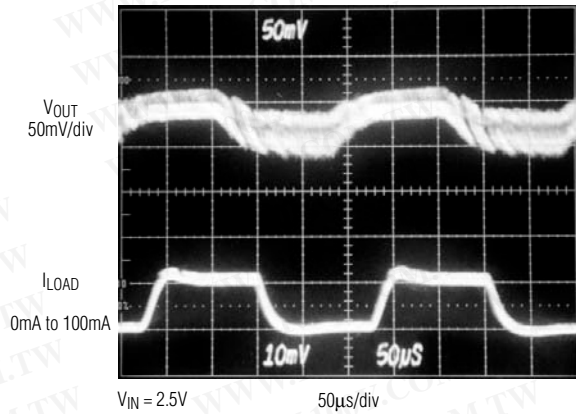

**MAX859 LINE-TRANSIENT RESPONSE**

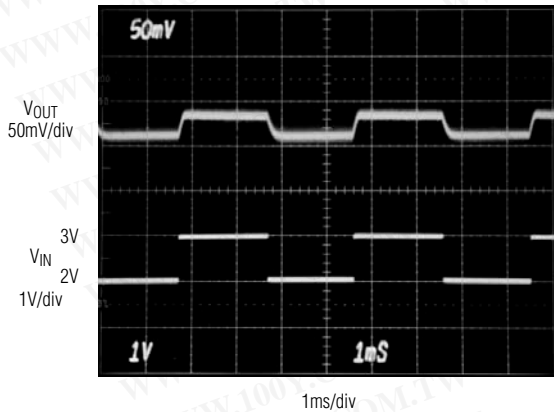

**MAX858/MAX859 LOAD-TRANSIENT RESPONSE**

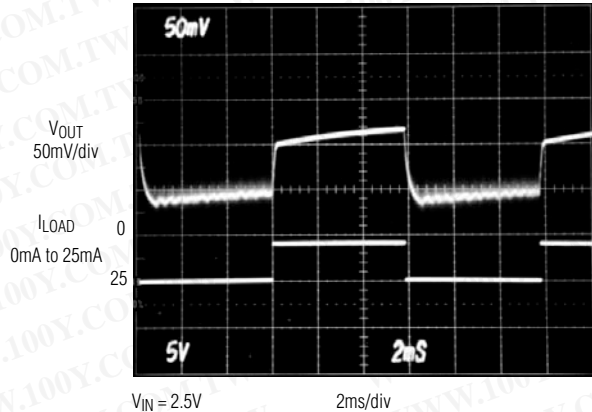

**MAX856 START-UP DELAY (5V MODE)**

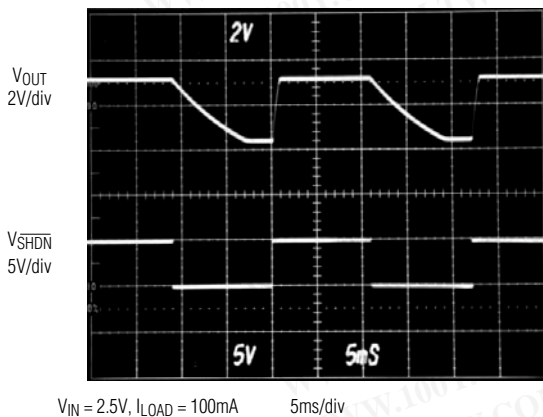

**MAX858/MAX859 START-UP DELAY (5V MODE)**

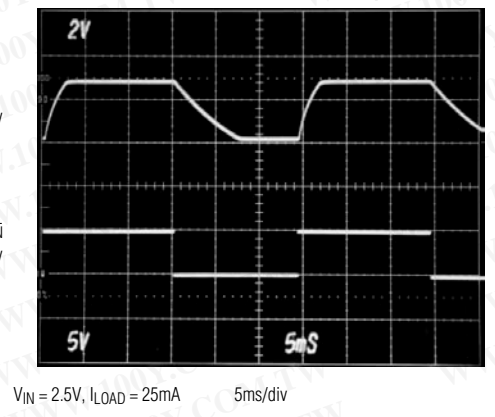

## 3.3V/5V or Adjustable-Output, Step-Up DC-DC Converters

### Pin Description

PIN		NAME	FUNCTION
MAX856 MAX858	MAX857 MAX859		
1	1	$\overline{\text{SHDN}}$	Shutdown Input. When low, the entire circuit is off and $V_{\text{OUT}} = V_{\text{IN}} - V_{\text{D}}$ , where $V_{\text{D}}$ is the forward voltage drop of the external Schottky rectifier.
2	—	3/5	Selects the output voltage; connect to GND for 5V output, and to OUT for 3.3V output.
—	2	FB	Feedback Input for adjustable-output operation. Connect to an external resistor voltage divider between OUT and GND.
3	3	REF	1.25V Reference Voltage Output. Bypass with 0.22 $\mu\text{F}$ to GND (0.1 $\mu\text{F}$ if there is no external reference load). Maximum load capability is 250 $\mu\text{A}$ source, 20 $\mu\text{A}$ sink.
4	4	LBO	Low-Battery Output. An open-drain N-channel MOSFET sinks current when the voltage at LBI drops below 1.25V.
5	5	LBI	Low-Battery Input. When the voltage on LBI drops below 1.25V, LBO sinks current. If not used, connect to $V_{\text{IN}}$ .
6	6	OUT	Connect OUT to the regulator output. OUT provides bootstrap power to the IC.
7	7	GND	Power Ground. Must be low impedance; solder directly to ground plane.
8	8	LX	N-Channel Power-MOSFET Drain

### Detailed Description

#### Operating Principle

The MAX856-MAX859 combine a switch-mode regulator, N-channel power MOSFET, precision voltage reference, and power-fail detector in a single monolithic device. The MOSFET is a “sense-FET” type for best efficiency, and has a very low gate threshold voltage to ensure start-up with low battery voltages (0.8V typ).

#### PFM Control Scheme

A unique minimum-off-time, current-limited pulse-frequency modulation (PFM) control scheme is a key feature of the MAX856 series (Figure 1). This scheme combines the high output power and efficiency of a pulse-width modulation (PWM) device with the ultra-low quiescent current of a traditional PFM pulse-skipper. There is no oscillator; at heavy loads, switching is accomplished through a constant-peak-current limit in the switch, which allows the inductor current to vary between this peak limit and some lesser value. At light loads, switching frequency is governed by a pair of one-shots, which set a minimum off-time (1 $\mu\text{s}$ ) and a maximum on-time (4 $\mu\text{s}$ ). The switching frequency depends upon the load and the input voltage, and can range up to 500kHz.

The peak switch current of the internal MOSFET power switch is fixed at 500mA  $\pm$  100mA (MAX856/MAX857) or 125mA  $\pm$  25mA (MAX858/MAX859). The switch’s on-resistance is typically 1 $\Omega$  (MAX856/MAX857) or 4 $\Omega$  (MAX858/MAX859), resulting in a switch voltage drop ( $V_{\text{SW}}$ ) of about 500mV under high output loads. The value of  $V_{\text{SW}}$  will decrease with light current loads.

Conventional PWM converters generate constant-frequency switching noise, whereas the unique architecture of the MAX856-MAX859 produces variable-frequency switching noise. However, unlike conventional pulse-skippers (where noise amplitude varies with input voltage), noise in the MAX856 series does not exceed the switch current limit times the filter-capacitor equivalent series resistance (ESR).

#### Voltage Reference

The precision voltage reference is suitable for driving external loads, such as an analog-to-digital converter. The voltage-reference output changes less than  $\pm 2\%$  when sourcing up to 250 $\mu\text{A}$  and sinking up to 20 $\mu\text{A}$ . If the reference drives an external load, bypass it with 0.22 $\mu\text{F}$  to GND. If the reference is unloaded, bypass it with at least 0.1 $\mu\text{F}$ .

# 3.3V/5V or Adjustable-Output, Step-Up DC-DC Converters

**MAX856-MAX859**

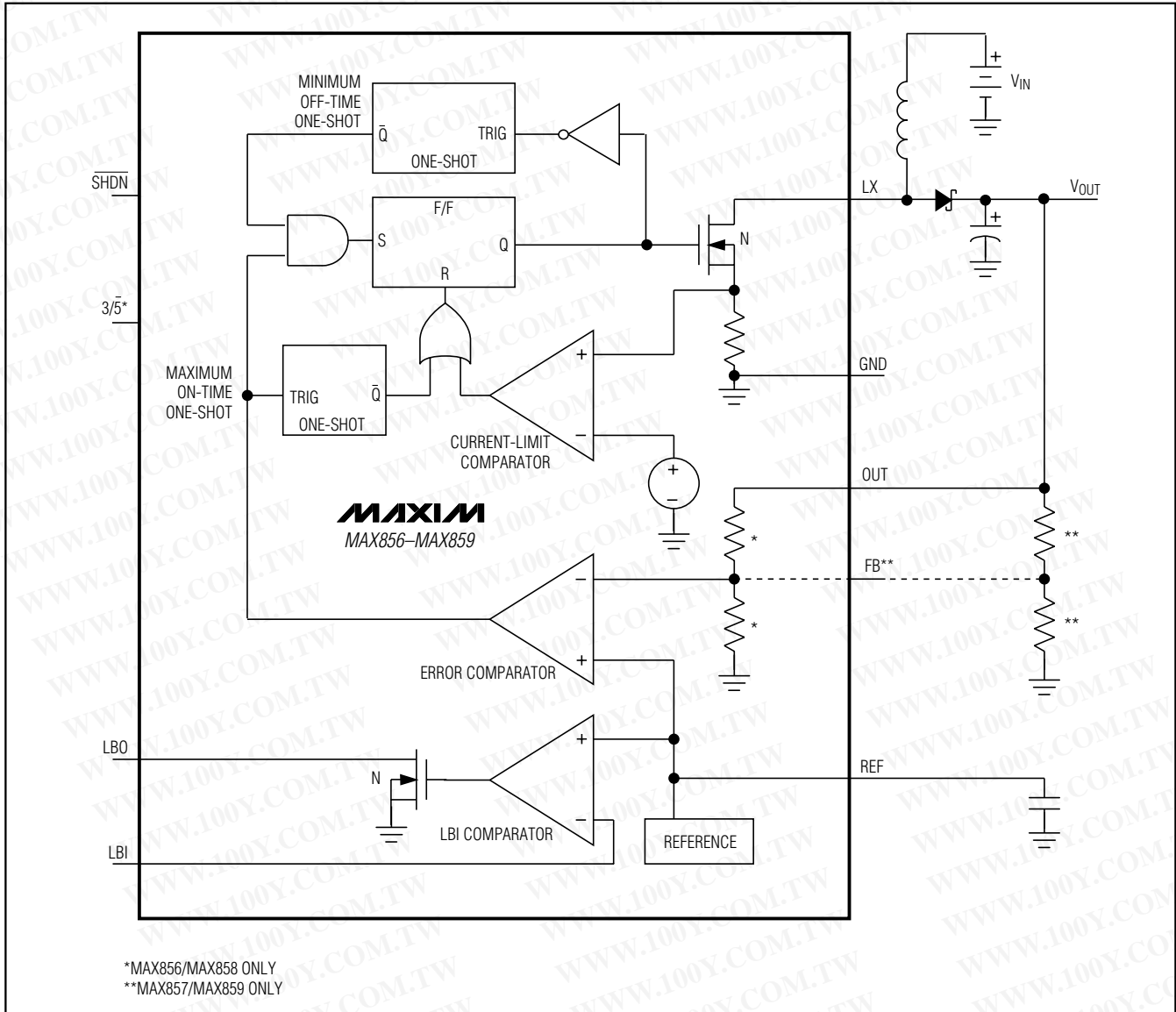

Figure 1. Block Diagram

## 3.3V/5V or Adjustable-Output, Step-Up DC-DC Converters

### Logic Inputs and Outputs

The  $\overline{3/5}$  input is internally diode clamped to GND and OUT, and should not be connected to signals outside this range. The SHDN input and LBO output (open-drain) are not clamped to V+ and can be pulled as high as 7V regardless of the voltage at OUT. **Do not leave control inputs ( $\overline{3/5}$ , LBI, or SHDN) floating.**

### Design Procedure

#### Output Voltage Selection

For the MAX856/MAX858, you can select a 3.3V or 5V output voltage under logic control, or by tying  $\overline{3/5}$  to GND or OUT. Efficiency is typically better than 80% over a 2mA to 100mA (MAX856/MAX857) load range. The device is internally bootstrapped, with power derived from the output voltage (via OUT). When the output is in 5V mode, the higher internal supply voltage results in lower switch-transistor on-resistance, slightly greater output power, and higher efficiency. Bootstrapping allows the battery voltage to sag to 0.8V once the system is started. Therefore, the battery voltage ranges from ( $V_{OUT} + V_D$ ) to 0.8V (where  $V_D$  is the forward drop of the Schottky rectifier). If the battery voltage exceeds the programmed output voltage, the out-

put will follow the battery voltage. This is acceptable in many systems; however, the input or output voltage must not be forced above 7V.

The MAX857/MAX859's output voltage is set by two resistors, R1 and R2 (Figure 2b), which form a voltage divider between the output and FB. Use the following equation to determine the output voltage:

$$V_{OUT} = V_{REF} \left( \frac{R1 + R2}{R2} \right)$$

where  $V_{REF} = 1.25V$ .

To simplify resistor selection:

$$R1 = R2 \left( \frac{V_{OUT}}{V_{REF}} - 1 \right)$$

Since the input bias current at FB has a maximum value of 100nA, large values (10k $\Omega$  to 300k $\Omega$ ) can be used for R1 and R2 with no significant accuracy loss. For 1% error, the current through R1 should be at least 100 times FB's bias current.

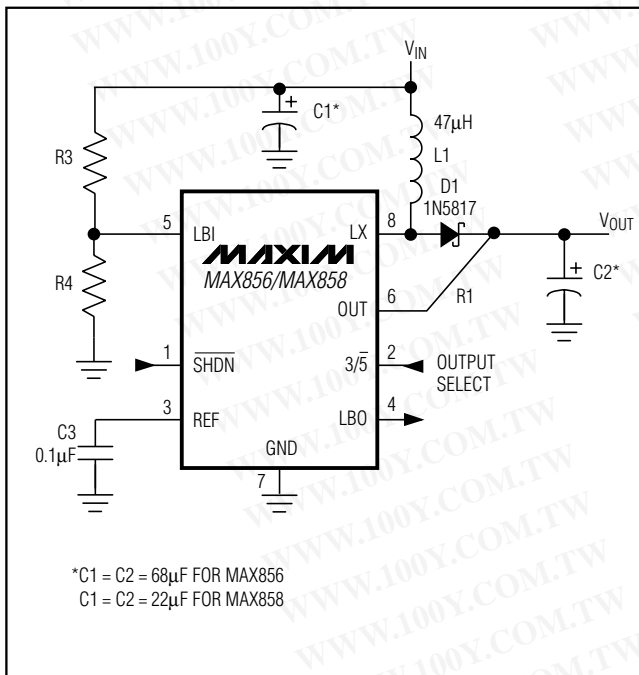

Figure 2a. Standard Application Circuit—Preset Output Voltage

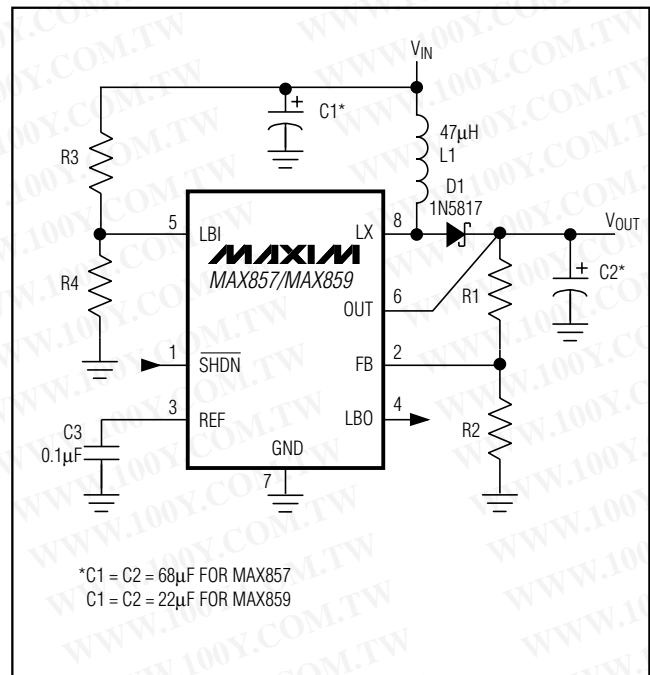

Figure 2b. Standard Application Circuit—Adjustable Output Voltage



## 3.3V/5V or Adjustable-Output, Step-Up DC-DC Converters

### Low-Battery Detection

The MAX856 series contains an on-chip comparator for low-battery detection. If the voltage at LBI falls below the regulator's internal reference voltage (1.25V), LBO (an open-drain output) sinks current to GND. The low-battery monitor's threshold is set by two resistors, R3 and R4 (Figure 2). Set the threshold voltage using the following equation:

$$R3 = R4 \left( \frac{V_{LBI}}{V_{REF}} - 1 \right)$$

where  $V_{LBI}$  is the desired threshold of the low-battery detector and  $V_{REF}$  is the internal 1.25V reference.

Since the LBI current is less than 100nA, large resistor values (typically 10k $\Omega$  to 300k $\Omega$ ) can be used for R3 and R4 to minimize loading of the input supply.

When the voltage at LBI is below the internal threshold, LBO sinks current to GND. Connect a pull-up resistor of 10k $\Omega$  or more from LBO to OUT when driving CMOS circuits. When LBI is above the threshold, the LBO output is off. If the low-battery comparator is not used, connect LBI to  $V_{IN}$  and leave LBO open.

### Inductor Selection

An inductor value of 47 $\mu$ H performs well in most MAX856-MAX859 applications. However, the inductance value is not critical, and the MAX856-MAX859 will work with inductors in the 10 $\mu$ H to 100 $\mu$ H range. Smaller inductance values typically offer a smaller physical size for a given series resistance, allowing the smallest overall circuit dimensions. However, due to higher peak inductor currents, the output voltage ripple ( $I_{PEAK} \times$  output filter capacitor ESR) also tends to be higher. Circuits using larger inductance values exhibit higher output current capability and larger physical dimensions for a given series resistance.

The inductor's incremental saturation current rating should be greater than the peak switch-current limit, which is 500mA for the MAX856/MAX857, and 125mA for the MAX858/MAX859. However, it is generally acceptable to bias the inductor into saturation by as much as 20%, although this will slightly reduce efficiency.

The inductor's DC resistance significantly affects efficiency. See the Efficiency vs. Load Current for Various Inductors graph in the *Typical Operating Characteristics*. See Tables 1 and 2 for a list of suggested inductor suppliers.

### Capacitor Selection

A 68 $\mu$ F, 10V, 0.85 $\Omega$ , surface-mount tantalum (SMT) output filter capacitor typically provides 50mV output ripple when stepping up from 2V to 5V at 100mA (MAX856/ MAX857). Smaller capacitors (down to 10 $\mu$ F with higher ESRs) are acceptable for light loads or in applications that can tolerate higher output ripple. Values in the 10 $\mu$ F to 47 $\mu$ F range are recommended for the MAX858/MAX859.

The equivalent series resistance (ESR) of both bypass and filter capacitors affects efficiency and output ripple. The output voltage ripple is the product of the peak inductor current and the output capacitor's ESR. Use low-ESR capacitors for best performance, or connect two or more filter capacitors in parallel. Low-ESR, SMT tantalum capacitors are currently available from Sprague (595D series) and AVX (TPS series). Sanyo OS-CON organic-semiconductor through-hole capacitors also exhibit very low ESR, and are especially useful for operation at cold temperatures. See Table 1 for a list of suggested capacitor suppliers.

### Rectifier Diode

For optimum performance, a switching Schottky diode (such as the 1N5817) is recommended. Refer to Table 1 for a list of component suppliers. For low output power applications, a PN-junction switching diode (such as the 1N4148) will also work well, although its greater forward voltage drop will reduce efficiency.

### PC Layout and Grounding

The MAX856 series' high-frequency operation makes PC layout important for minimizing ground bounce and noise. Keep the IC's GND pin and the ground leads of C1 and C2 (Figure 1) less than 0.2in (5mm) apart. Also keep all connections to the FB and LX pins as short as possible. To maximize output power and efficiency and minimize output ripple voltage, use a ground plane and solder the IC's GND (pin 7) directly to the ground plane.

## 3.3V/5V or Adjustable-Output, Step-Up DC-DC Converters

Table 1. Component Suppliers

PRODUCTION METHOD	INDUCTORS	CAPACITORS	RECTIFIERS
Surface Mount	See Table 2	Matsuo 267 series Sprague 595D series AVX TPS series	Motorola MBR 0530 Nihon EC15QS02L
Miniature Through Hole	Sumida RCH654-220	Sanyo OS-CON series low-ESR organic semiconductor	
Low-Cost Through Hole	Renco RL 1284-22 CoilCraft PCH-27-223	Maxim MAXC001 150 $\mu$ F, low-ESR electrolytic Nichicon PL series low-ESR electrolytic United Chemi-Con LXF series	Motorola 1N5817

COMPANY	PHONE	FAX
AVX	USA: (207) 282-5111	(207) 283-1941
CoilCraft	USA: (708) 639-6400	(708) 639-1469
Coiltronics	USA: (407) 241-7876	(407) 241-9339
Matsuo	USA: (714) 969-2491	(714) 960-6492
Motorola	USA: (408) 749-0510 (800) 521-6274	
Murata-Erie	USA: (800) 831-9172	(404) 684-1541
Nichicon	USA: (708) 843-7500	(708) 843-2798
Nihon	USA: (805) 867-2555 Japan: 81-3-3494-7411	(805) 867-2556 81-3-3494-7414
Renco	USA: (516) 586-5566	(516) 586-5562
Sanyo	USA: (619) 661-6835 Japan: 81-7-2070-6306	(619) 661-1055 81-7-2070-1174
Sumida	USA: (708) 956-0666 Japan: 81-3-3607-5111	(708) 956-0702 81-3-3607-5144
TDK	USA: (708) 803-6100 Japan: 03-3278-5111	(708) 803-6294 03-3278-5358
United Chemi-Con	USA: (714) 255-9500	(714) 255-9400

# 3.3V/5V or Adjustable-Output, Step-Up DC-DC Converters

**MAX856-MAX859**

**Table 2. Surface-Mount Inductor Information**

MANUFACTURER PART	INDUCTANCE (μH)	RESISTANCE (Ω)	RATED CURRENT (A)	HEIGHT (mm)
Sumida CDR105B-470	47	0.14	1.0	5.0
Sumida CDR74B-470	47	0.27	0.8	4.5
Sumida CD43-470	47	0.85	0.540	3.2
Sumida CD43-220	22	0.38	0.760	3.2
Murata-Erie LQH4N220	22	0.94	0.320	2.6
Murata-Erie LQH4N470	47	1.5	0.220	2.6
Murata-Erie LQH1N220	22	3.1	0.85	1.8
TDK NLC322522T-220K	22	1.15	0.210	2.2
TDK NLC322522T-470K	47	2.25	0.150	2.2
Coiltronics CTX20-1	20	0.175	1.15	4.2
Coilcraft DT1608-223	22	0.16	0.500	3.2

## Ordering Information (continued)

PART	TEMP. RANGE	PIN-PACKAGE
MAX858CSA	0°C to +70°C	8 SO
MAX858CUA	0°C to +70°C	8 μMAX
MAX858C/D	0°C to +70°C	Dice*
MAX858ESA	-40°C to +85°C	8 SO
MAX858MJA	-55°C to +125°C	8 CERDIP†
MAX859CSA	0°C to +70°C	8 SO
MAX859CUA	0°C to +70°C	8 μMAX
MAX859C/D	0°C to +70°C	Dice*
MAX859ESA	-40°C to +85°C	8 SO
MAX859MJA	-55°C to +125°C	8 CERDIP†

\* Dice are tested at  $T_A = +25^\circ\text{C}$  only.  
 † Contact factory for availability.

## Chip Topography

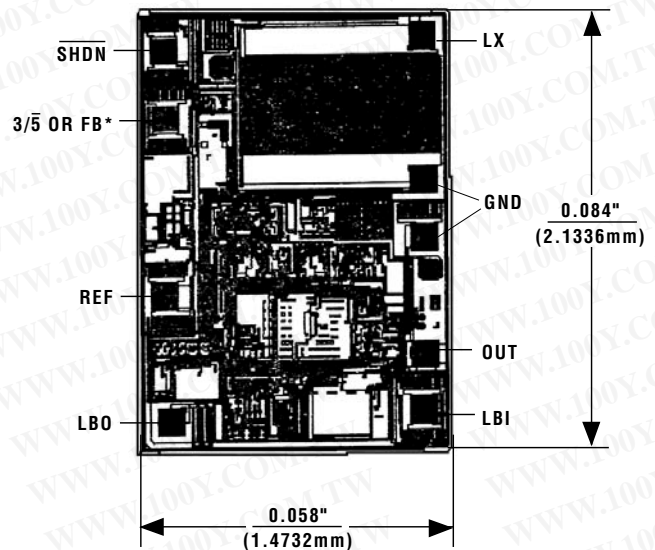

\*3/5 FOR MAX856/MAX858; FB FOR MAX857/MAX859.

TRANSISTOR COUNT: 357;  
 SUBSTRATE CONNECTED TO OUT.

# 3.3V/5V or Adjustable-Output, Step-Up DC-DC Converters

勝特力材料 886-3-5753170  
 勝特力电子(上海) 86-21-34970699  
 勝特力电子(深圳) 86-755-83298787  
[Http://www.100y.com.tw](http://www.100y.com.tw)

## Package Information

DIM	INCHES		MILLIMETERS	
	MIN	MAX	MIN	MAX
A	0.036	0.044	0.91	1.11
A1	0.004	0.008	0.10	0.20
B	0.010	0.014	0.25	0.36
C	0.005	0.007	0.13	0.18
D	0.116	0.120	2.95	3.05
E	0.116	0.120	2.95	3.05
e	0.0256		0.65	
H	0.188	0.198	4.78	5.03
L	0.016	0.026	0.41	0.66
α	0°	6°	0°	6°

**8-PIN  $\mu$ MAX  
MICROMAX SMALL OUTLINE  
PACKAGE**

DIM	INCHES		MILLIMETERS	
	MIN	MAX	MIN	MAX
A	0.053	0.069	1.35	1.75
A1	0.004	0.010	0.10	0.25
B	0.014	0.019	0.35	0.49
C	0.007	0.010	0.19	0.25
E	0.150	0.157	3.80	4.00
e	0.050		1.27	
H	0.228	0.244	5.80	6.20
L	0.016	0.050	0.40	1.27

DIM	PINS	INCHES		MILLIMETERS	
		MIN	MAX	MIN	MAX
D	8	0.189	0.197	4.80	5.00
D	14	0.337	0.344	8.55	8.75
D	16	0.386	0.394	9.80	10.00

**Narrow SO  
SMALL-OUTLINE  
PACKAGE  
(0.150 in.)**

21-0041A