

LM2937-2.5, LM2937-3.3 400mA and 500mA Voltage Regulators

General Description

The LM2937-2.5 and LM2937-3.3 are positive voltage regulators capable of supplying up to 500 mA of load current. Both regulators are ideal for converting a common 5V logic supply, or higher input supply voltage, to the lower 2.5V and 3.3V supplies to power VLSI ASIC's and microcontrollers. Special circuitry has been incorporated to minimize the quiescent current to typically only 10 mA with a full 500 mA load current when the input to output voltage differential is greater than 5V.

The LM2937 requires an output bypass capacitor for stability. As with most regulators utilizing a PNP pass transistor, the ESR of this capacitor remains a critical design parameter, but the LM2937-2.5 and LM2937-3.3 include special compensation circuitry that relaxes ESR requirements. The LM2937 is stable for all ESR ratings less than 5Ω. This allows the use of low ESR chip capacitors.

The regulators are also suited for automotive applications, with built in protection from reverse battery connections,

two-battery jumps and up to +60V/-50V load dump transients. Familiar regulator features such as short circuit and thermal shutdown protection are also built in.

Features

- Fully specified for operation over -40°C to +125°C
- Output current in excess of 500 mA (400mA for SOT-223 package)
- Output trimmed for 5% tolerance under all operating conditions
- Wide output capacitor ESR range, 0.01Ω up to 5Ω
- Internal short circuit and thermal overload protection
- Reverse battery protection
- 60V input transient protection
- Mirror image insertion protection

Connection Diagrams and Ordering Information

TO-220 Plastic Package

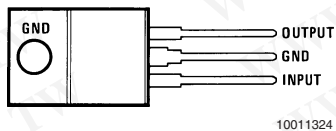

10011324

Front View

Order Number LM2937ET-2.5, LM2937ET-3.3,
See NS Package Number T03B

SOT-223 Plastic Package

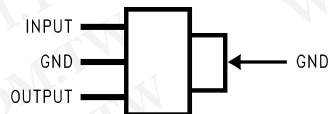

10011325

Front View

Order Number LM2937IMP-2.5, LM2937IMP-3.3,
See NS Package Number MA04A

TO-263 Surface-Mount Package

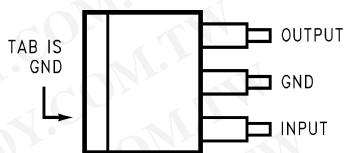

10011326

Top View

Order Number LM2937ES-2.5, LM2937ES-3.3,
See NS Package Number TS3B



10011327

Side View

勝特力材料 886-3-5753170
 勝特力电子(上海) 86-21-34970699
 勝特力电子(深圳) 86-755-83298787
[Http://www.100y.com.tw](http://www.100y.com.tw)

LM2937-2.5, LM2937-3.3 400mA and 500mA Voltage Regulators

Connection Diagrams and Ordering Information (Continued)

Temperature Range	Output Voltage		NSC Package Drawing	Package
	2.5	3.3		
$-40^{\circ}\text{C} \leq T_A \leq 125^{\circ}\text{C}$	LM2937ES-2.5	LM2937ES-3.3	TS3B	TO-263
	LM2937ET-2.5	LM2937ET-3.3	T03B	TO-220
$-40^{\circ}\text{C} \leq T_A \leq 85^{\circ}\text{C}$	LM2937IMP-2.5	LM2937IMP-3.3	MA04A	SOT-223
SOT-223 Package Markings	L68B	L69B		

The small physical size of the SOT-223 package does not allow sufficient space to provide the complete device part number. The actual devices will be labeled with the package markings shown.

Absolute Maximum Ratings (Note 1)

If Military/Aerospace specified devices are required, please contact the National Semiconductor Sales Office/Distributors for availability and specifications.

Input Voltage	
Continuous	26V
Transient (t ≤ 100 ms)	60V
Internal Power Dissipation (Note 2)	Internally Limited
Maximum Junction Temperature	150°C
Storage Temperature Range	-65°C to +150°C
Lead Temperature Soldering	
TO-220 (10 seconds)	260°C
TO-263 (10 seconds)	230°C

SOT-223 (Vapor Phase, 60 seconds)	215°C
SOT-223 (Infrared, 15 seconds)	220°C
ESD Susceptibility (Note 3)	2 kV

Operating Conditions(Note 1)

Temperature Range (Note 2)	
LM2937ES, LM2937ET	-40°C ≤ T _A ≤ 125°C
LM2937IMP	-40°C ≤ T _A ≤ 85°C
Input Voltage Range	4.75V to 26V

Electrical Characteristics(Note 4)

V_{IN} = V_{NOM} + 5V, I_{OUTmax} = 500 mA for the TO-220 and TO-263 packages, I_{OUTmax} = 400mA for the SOT-223 package, C_{OUT} = 10 μF unless otherwise indicated. **Boldface limits apply over the entire operating temperature range, of the indicated device**, all other specifications are for T_A = T_J = 25°C.

Output Voltage (V _{OUT})		2.5V		3.3V		Units
Parameter	Conditions	Typ	Limit	Typ	Limit	
Output Voltage	5 mA ≤ I _{OUT} ≤ I _{OUTmax}		2.42		3.20	V (Min)
		2.5	2.38	3.3	3.14	V(Min)
			2.56		3.40	V(Max)
			2.62		3.46	V(Max)
Line Regulation(Note 5)	4.75V ≤ V _{IN} ≤ 26V, I _{OUT} = 5 mA	7.5	25	9.9	33	mV(Max)
Load Regulation	5 mA ≤ I _{OUT} ≤ I _{OUTmax}	2.5	25	3.3	33	mV(Max)
Quiescent Current	7V ≤ V _{IN} ≤ 26V, I _{OUT} = 5 mA	2	10	2	10	mA(Max)
	V _{IN} = (V _{OUT} + 5V), I _{OUT} = I _{OUTmax}	10	20	10	20	mA(Max)
	V _{IN} = 5V, I _{OUT} = I _{OUTmax}	66	100125	66	100125	mA(Max)
Output Noise Voltage	10 Hz–100 kHz, I _{OUT} = 5 mA	75		99		μVrms
Long Term Stability	1000 Hrs.	10		13.2		mV
Short-Circuit Current		1.0	0.6	1.0	0.6	A(Min)
Peak Line Transient Voltage	t _f < 100 ms, R _L = 100Ω	75	60	75	60	V(Min)
Maximum Operational Input Voltage			26		26	V(Min)
Reverse DC Input Voltage	V _{OUT} ≥ -0.6V, R _L = 100Ω	-30	-15	-30	-15	V(Min)
Reverse Transient Input Voltage	t _r < 1 ms, R _L = 100Ω	-75	-50	-75	-50	V(Min)

Note 1: Absolute Maximum Ratings indicate limits beyond which damage to the device may occur. Electrical specifications do not apply when operating the device outside of its rated Operating Conditions.

Note 2: The maximum allowable power dissipation at any ambient temperature is P_{MAX} = (125 - T_A)/θ_{JA}, where 125 is the maximum junction temperature for operation, T_A is the ambient temperature, and θ_{JA} is the junction-to-ambient thermal resistance. If this dissipation is exceeded, the die temperature will rise above 125°C and the electrical specifications do not apply. If the die temperature rises above 150°C, the regulator will go into thermal shutdown. The junction-to-ambient thermal resistance θ_{JA} is 65°C/W, for the TO-220 package, 73°C/W for the TO-263 package, and 174°C/W for the SOT-223 package. When used with a heatsink, θ_{JA} is the sum of the device junction-to-case thermal resistance θ_{JC} of 3°C/W and the heatsink case-to-ambient thermal resistance. If the TO-263 or SOT-223 packages are used, the thermal resistance can be reduced by increasing the P.C. board copper area thermally connected to the package (see Application Hints for more information on heatsinking).

Note 3: ESD rating is based on the human body model, 100 pF discharged through 1.5 kΩ.

Note 4: Typicals are at T_J = 25°C and represent the most likely parametric norm.

Electrical Characteristics (Note 4) (Continued)

Note 5: The minimum input voltage required for proper biasing of these regulators is 4.75V. Below this level the outputs will fall out of regulation. This effect is not the normal dropout characteristic where the output falls out of regulation due to the PNP pass transistor entering saturation. If a value for worst case effective input to output dropout voltage is required in a specification, the values should be 2.37V maximum for the LM2937-2.5 and 1.6V maximum for the LM2937-3.3.

Typical Performance Characteristics

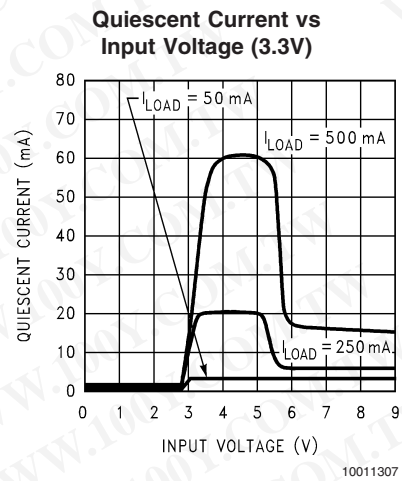
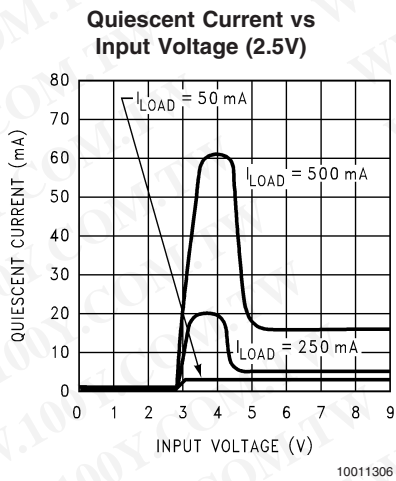
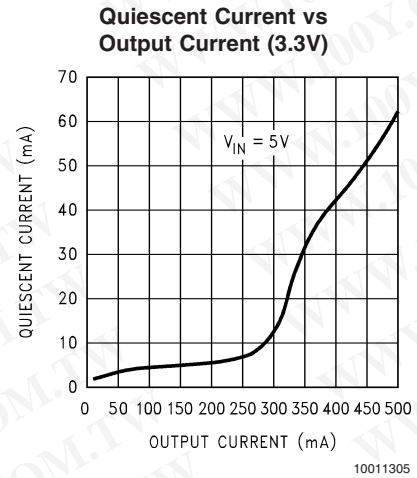
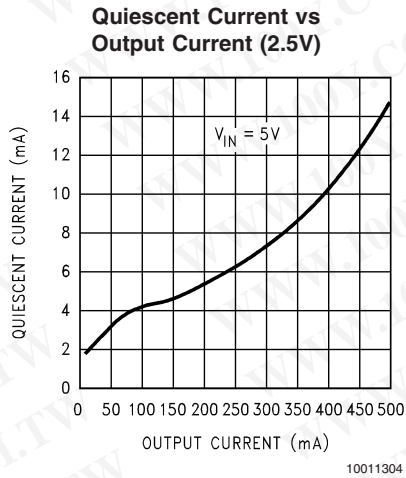
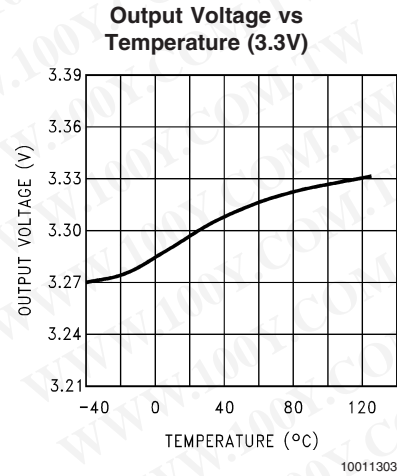
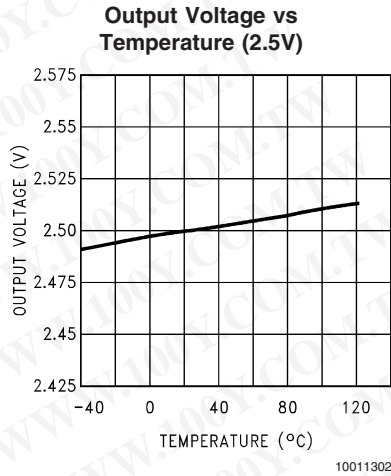

Typical Performance Characteristics (Continued)

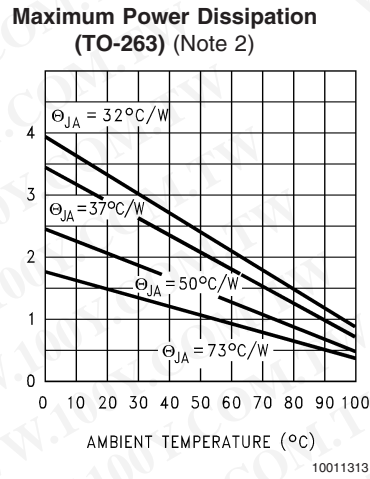
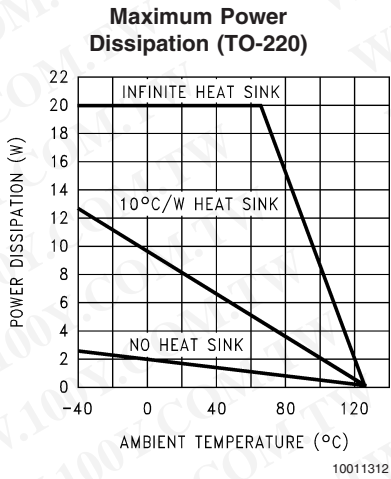
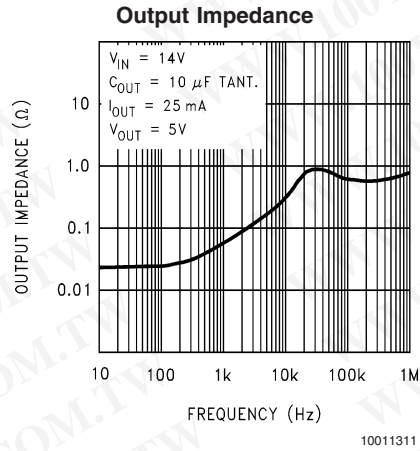
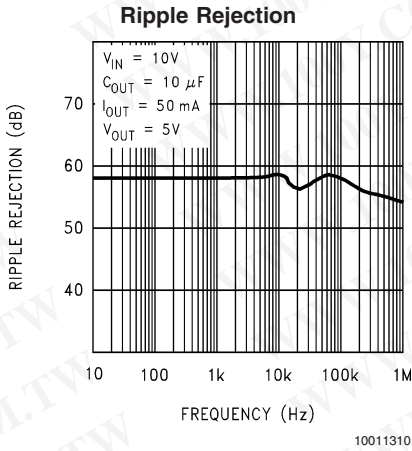
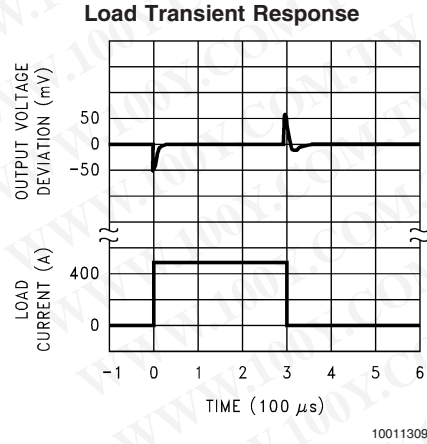
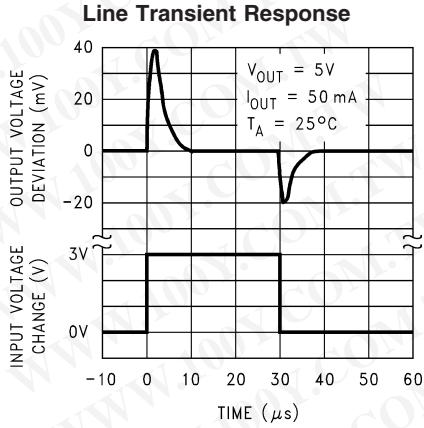

Typical Performance Characteristics (Continued)

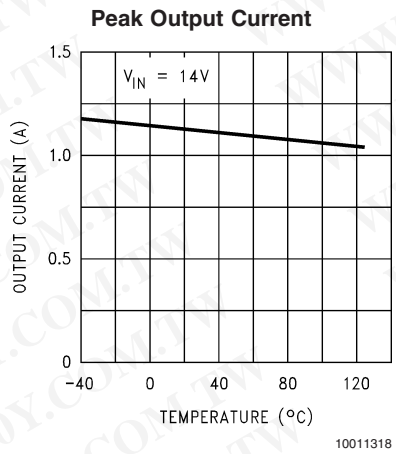
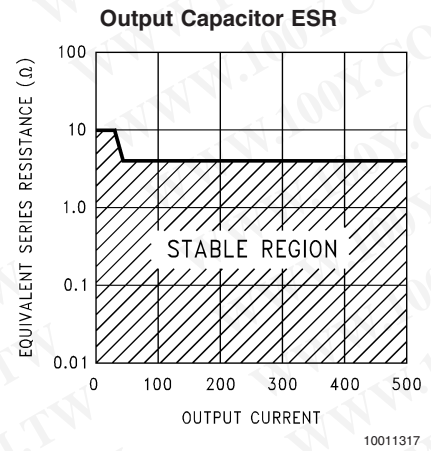
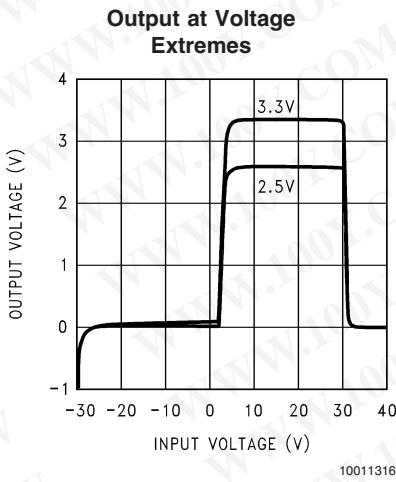
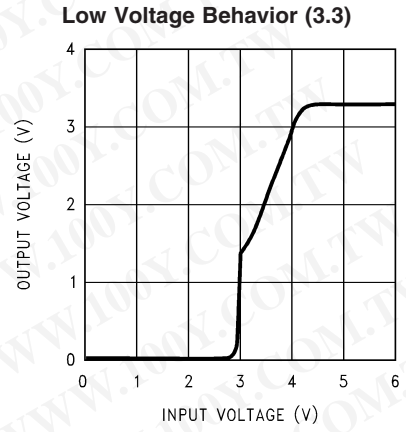
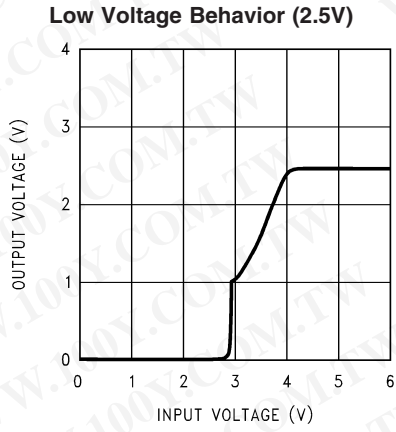

Typical Application

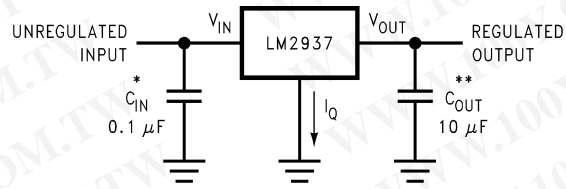

10011301

* Required if the regulator is located more than 3 inches from the power supply filter capacitors.

** Required for stability. C_{out} must be at least $10\ \mu\text{F}$ (over the full expected operating temperature range) and located as close as possible to the regulator. The equivalent series resistance, ESR, of this capacitor may be as high as $3\ \Omega$.

Application Hints

EXTERNAL CAPACITORS

The output capacitor is critical to maintaining regulator stability, and must meet the required conditions for both ESR (Equivalent Series Resistance) and minimum amount of capacitance.

MINIMUM CAPACITANCE:

The minimum output capacitance required to maintain stability is 10 μF (this value may be increased without limit). Larger values of output capacitance will give improved transient response.

ESR LIMITS:

The ESR of the output capacitor will cause loop instability if it is too high or too low. The acceptable range of ESR plotted versus load current is shown in the graph below. **It is essential that the output capacitor meet these requirements, or oscillations can result.**

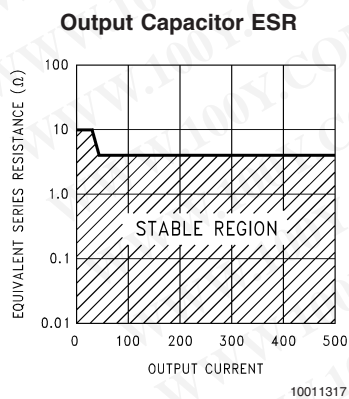

FIGURE 1. ESR Limits

It is important to note that for most capacitors, ESR is specified only at room temperature. However, the designer must ensure that the ESR will stay inside the limits shown over the entire operating temperature range for the design.

For aluminum electrolytic capacitors, ESR will increase by about 30X as the temperature is reduced from 25°C to -40°C. This type of capacitor is not well-suited for low temperature operation.

Solid tantalum capacitors have a more stable ESR over temperature, but are more expensive than aluminum electrolytics. A cost-effective approach sometimes used is to parallel an aluminum electrolytic with a solid Tantalum, with the total capacitance split about 75/25% with the Aluminum being the larger value.

If two capacitors are paralleled, the effective ESR is the parallel of the two individual values. The "flatter" ESR of the Tantalum will keep the effective ESR from rising as quickly at low temperatures.

HEATSINKING

A heatsink may be required depending on the maximum power dissipation and maximum ambient temperature of the application. Under all possible operating conditions, the junction temperature must be within the range specified under Absolute Maximum Ratings.

To determine if a heatsink is required, the power dissipated by the regulator, P_D , must be calculated.

The figure below shows the voltages and currents which are present in the circuit, as well as the formula for calculating the power dissipated in the regulator:

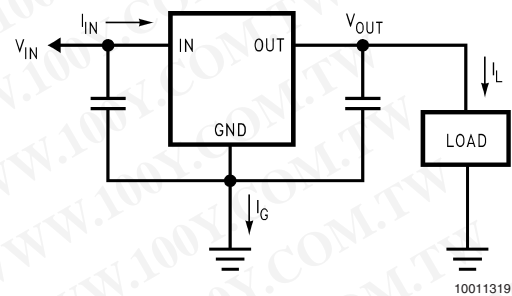

$$I_{IN} = I_L + I_G$$

$$P_D = (V_{IN} - V_{OUT}) I_L + (V_{IN}) I_G$$

FIGURE 2. Power Dissipation Diagram

The next parameter which must be calculated is the maximum allowable temperature rise, T_R (max). This is calculated by using the formula:

$$T_R (\text{max}) = T_J (\text{max}) - T_A (\text{max})$$

where: T_J (max) is the maximum allowable junction temperature, which is 125°C for commercial grade parts.

T_A (max) is the maximum ambient temperature which will be encountered in the application.

Using the calculated values for T_R (max) and P_D , the maximum allowable value for the junction-to-ambient thermal resistance, $\theta_{(J-A)}$, can now be found:

$$\theta_{(J-A)} = T_R (\text{max})/P_D$$

IMPORTANT: If the maximum allowable value for $\theta_{(J-A)}$ is found to be $\geq 53^\circ\text{C/W}$ for the TO-220 package, $\geq 80^\circ\text{C/W}$ for the TO-263 package, or $\geq 174^\circ\text{C/W}$ for the SOT-223 package, no heatsink is needed since the package alone will dissipate enough heat to satisfy these requirements.

If the calculated value for $\theta_{(J-A)}$ falls below these limits, a heatsink is required.

HEATSINKING TO-220 PACKAGE PARTS

The TO-220 can be attached to a typical heatsink, or secured to a copper plane on a PC board. If a copper plane is to be used, the values of $\theta_{(J-A)}$ will be the same as shown in the next section for the TO-263.

If a manufactured heatsink is to be selected, the value of heatsink-to-ambient thermal resistance, $\theta_{(H-A)}$, must first be calculated:

$$\theta_{(H-A)} = \theta_{(J-A)} - \theta_{(C-H)} - \theta_{(J-C)}$$

Where: $\theta_{(J-C)}$ is defined as the thermal resistance from the junction to the surface of the case. A value of 3°C/W can be assumed for $\theta_{(J-C)}$ for this calculation.

$\theta_{(C-H)}$ is defined as the thermal resistance between the case and the surface of the heatsink. The value of $\theta_{(C-H)}$ will vary from about 1.5°C/W to about 2.5°C/W (depending on method of attachment, insulator, etc.). If the exact value is unknown, 2°C/W should be assumed for $\theta_{(C-H)}$.

Application Hints (Continued)

When a value for $\theta_{(H-A)}$ is found using the equation shown, a heatsink must be selected that has a value that is less than or equal to this number.

$\theta_{(H-A)}$ is specified numerically by the heatsink manufacturer in the catalog, or shown in a curve that plots temperature rise vs power dissipation for the heatsink.

HEATSINKING TO-263 AND SOT-223 PACKAGE PARTS

Both the TO-263 ("S") and SOT-223 ("MP") packages use a copper plane on the PCB and the PCB itself as a heatsink. To optimize the heat sinking ability of the plane and PCB, solder the tab of the package to the plane.

Figure 3 shows for the TO-263 the measured values of $\theta_{(J-A)}$ for different copper area sizes using a typical PCB with 1 ounce copper and no solder mask over the copper area used for heatsinking.

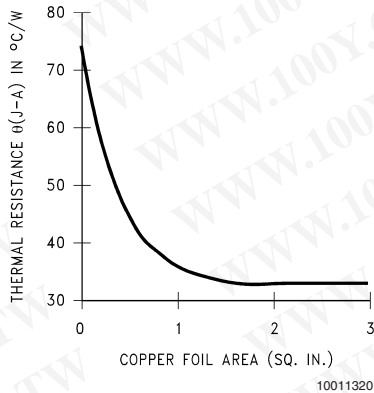

FIGURE 3. $\theta_{(J-A)}$ vs Copper (1 ounce) Area for the TO-263 Package

As shown in the figure, increasing the copper area beyond 1 square inch produces very little improvement. It should also be observed that the minimum value of $\theta_{(J-A)}$ for the TO-263 package mounted to a PCB is 32°C/W.

As a design aid, Figure 4 shows the maximum allowable power dissipation compared to ambient temperature for the TO-263 device (assuming $\theta_{(J-A)}$ is 35°C/W and the maximum junction temperature is 125°C).

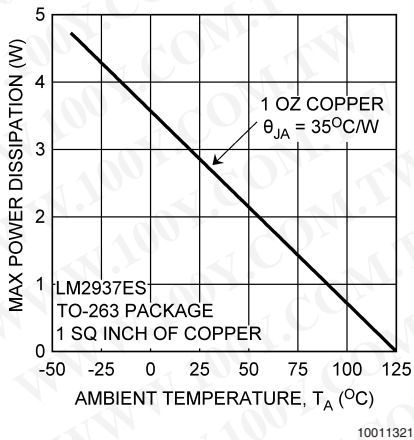

FIGURE 4. Maximum Power Dissipation vs T_{AMB} for the TO-263 Package

Figure 5 and Figure 6 show the information for the SOT-223 package. Figure 6 assumes a $\theta_{(J-A)}$ of 74°C/W for 1 ounce copper and 51°C/W for 2 ounce copper and a maximum junction temperature of +85°C.

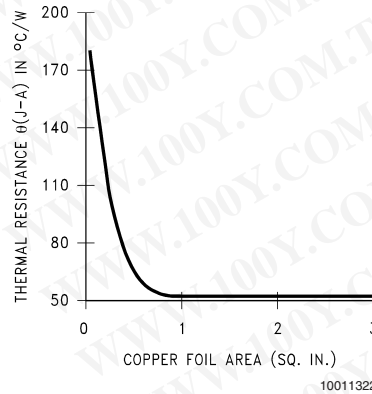

FIGURE 5. $\theta_{(J-A)}$ vs Copper (2 ounce) Area for the SOT-223 Package

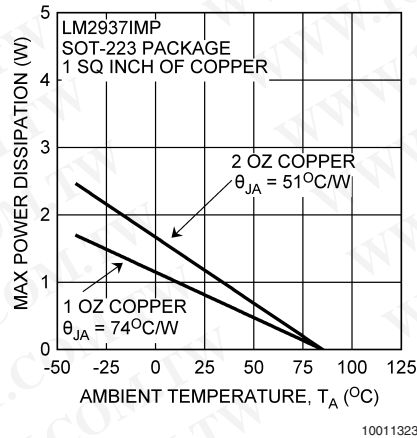

FIGURE 6. Maximum Power Dissipation vs T_{AMB} for the SOT-223 Package

Please see AN1028 for power enhancement techniques to be used with the SOT-223 package.

SOT-223 SOLDERING RECOMMENDATIONS

It is not recommended to use hand soldering or wave soldering to attach the small SOT-223 package to a printed circuit board. The excessive temperatures involved may cause package cracking.

Either vapor phase or infrared reflow techniques are preferred soldering attachment methods for the SOT-223 package.

Physical Dimensions inches (millimeters) unless otherwise noted

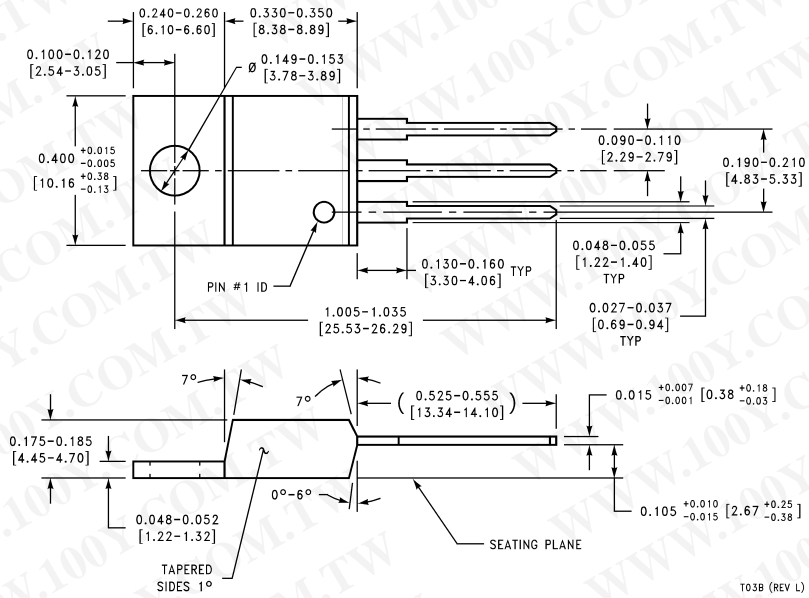

Plastic Package
Order Number LM2937ET-2.5,
LM2937ET-3.3,
NS Package Number T03B

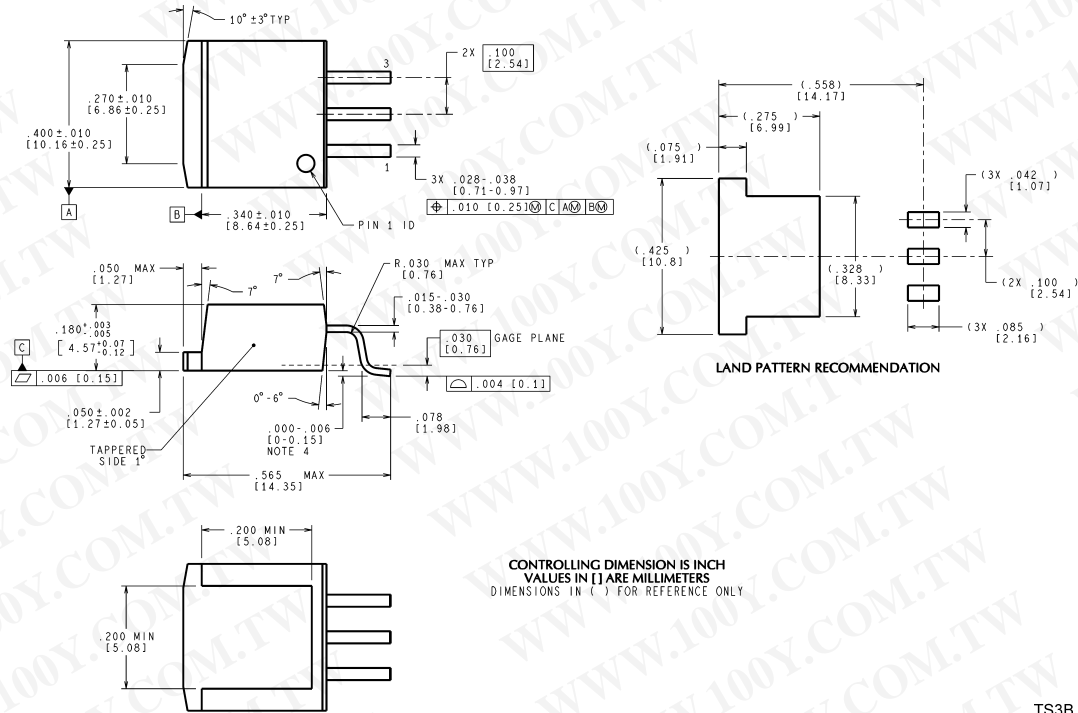

TO-263 3-Lead Plastic Surface Mount Package
Order Number LM2937ES-2.5, LM2937ES-3.3,
NS Package Number TS3B

Physical Dimensions inches (millimeters) unless otherwise noted (Continued)

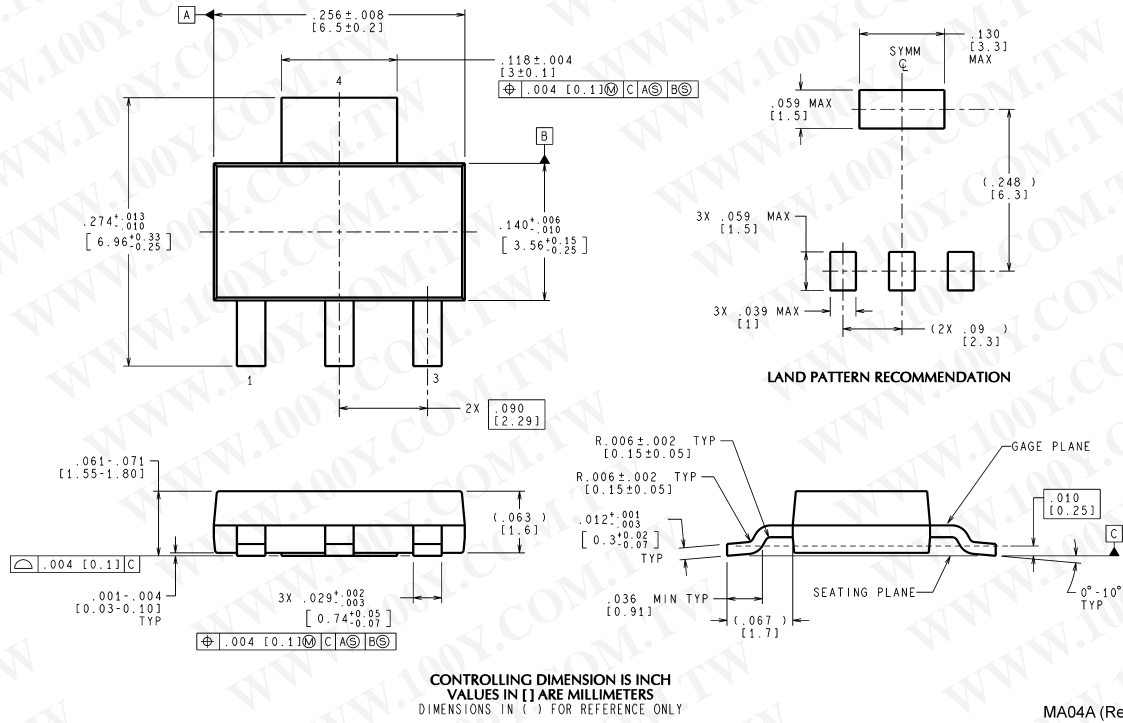

SOT-223 3-Lead Plastic Surface Mount Package
Order Number LM2937IMP-2.5, LM2937IMP-3.3,
NS Package Number MA04A

National does not assume any responsibility for use of any circuitry described, no circuit patent licenses are implied and National reserves the right at any time without notice to change said circuitry and specifications.
 For the most current product information visit us at www.national.com.

LIFE SUPPORT POLICY

NATIONAL'S PRODUCTS ARE NOT AUTHORIZED FOR USE AS CRITICAL COMPONENTS IN LIFE SUPPORT DEVICES OR SYSTEMS WITHOUT THE EXPRESS WRITTEN APPROVAL OF THE PRESIDENT AND GENERAL COUNSEL OF NATIONAL SEMICONDUCTOR CORPORATION. As used herein:

1. Life support devices or systems are devices or systems which, (a) are intended for surgical implant into the body, or (b) support or sustain life, and whose failure to perform when properly used in accordance with instructions for use provided in the labeling, can be reasonably expected to result in a significant injury to the user.
2. A critical component is any component of a life support device or system whose failure to perform can be reasonably expected to cause the failure of the life support device or system, or to affect its safety or effectiveness.

BANNED SUBSTANCE COMPLIANCE

National Semiconductor manufactures products and uses packing materials that meet the provisions of the Customer Products Stewardship Specification (CSP-9-111C2) and the Banned Substances and Materials of Interest Specification (CSP-9-111S2) and contain no "Banned Substances" as defined in CSP-9-111S2.
 Leadfree products are RoHS compliant.



National Semiconductor
Americas Customer Support Center
 Email: new.feedback@nsc.com
 Tel: 1-800-272-9959

National Semiconductor
Europe Customer Support Center
 Fax: +49 (0) 180-530 85 86
 Email: europe.support@nsc.com
 Deutsch Tel: +49 (0) 69 9508 6208
 English Tel: +44 (0) 870 24 0 2171
 Français Tel: +33 (0) 1 41 91 8790

National Semiconductor
Asia Pacific Customer Support Center
 Email: ap.support@nsc.com

National Semiconductor
Japan Customer Support Center
 Fax: 81-3-5639-7507
 Email: jpn.feedback@nsc.com
 Tel: 81-3-5639-7560

IMPORTANT NOTICE

Texas Instruments Incorporated and its subsidiaries (TI) reserve the right to make corrections, modifications, enhancements, improvements, and other changes to its products and services at any time and to discontinue any product or service without notice. Customers should obtain the latest relevant information before placing orders and should verify that such information is current and complete. All products are sold subject to TI's terms and conditions of sale supplied at the time of order acknowledgment.

TI warrants performance of its hardware products to the specifications applicable at the time of sale in accordance with TI's standard warranty. Testing and other quality control techniques are used to the extent TI deems necessary to support this warranty. Except where mandated by government requirements, testing of all parameters of each product is not necessarily performed.

TI assumes no liability for applications assistance or customer product design. Customers are responsible for their products and applications using TI components. To minimize the risks associated with customer products and applications, customers should provide adequate design and operating safeguards.

TI does not warrant or represent that any license, either express or implied, is granted under any TI patent right, copyright, mask work right, or other TI intellectual property right relating to any combination, machine, or process in which TI products or services are used. Information published by TI regarding third-party products or services does not constitute a license from TI to use such products or services or a warranty or endorsement thereof. Use of such information may require a license from a third party under the patents or other intellectual property of the third party, or a license from TI under the patents or other intellectual property of TI.

Reproduction of TI information in TI data books or data sheets is permissible only if reproduction is without alteration and is accompanied by all associated warranties, conditions, limitations, and notices. Reproduction of this information with alteration is an unfair and deceptive business practice. TI is not responsible or liable for such altered documentation. Information of third parties may be subject to additional restrictions.

Resale of TI products or services with statements different from or beyond the parameters stated by TI for that product or service voids all express and any implied warranties for the associated TI product or service and is an unfair and deceptive business practice. TI is not responsible or liable for any such statements.

TI products are not authorized for use in safety-critical applications (such as life support) where a failure of the TI product would reasonably be expected to cause severe personal injury or death, unless officers of the parties have executed an agreement specifically governing such use. Buyers represent that they have all necessary expertise in the safety and regulatory ramifications of their applications, and acknowledge and agree that they are solely responsible for all legal, regulatory and safety-related requirements concerning their products and any use of TI products in such safety-critical applications, notwithstanding any applications-related information or support that may be provided by TI. Further, Buyers must fully indemnify TI and its representatives against any damages arising out of the use of TI products in such safety-critical applications.

TI products are neither designed nor intended for use in military/aerospace applications or environments unless the TI products are specifically designated by TI as military-grade or "enhanced plastic." Only products designated by TI as military-grade meet military specifications. Buyers acknowledge and agree that any such use of TI products which TI has not designated as military-grade is solely at the Buyer's risk, and that they are solely responsible for compliance with all legal and regulatory requirements in connection with such use.

TI products are neither designed nor intended for use in automotive applications or environments unless the specific TI products are designated by TI as compliant with ISO/TS 16949 requirements. Buyers acknowledge and agree that, if they use any non-designated products in automotive applications, TI will not be responsible for any failure to meet such requirements.

Following are URLs where you can obtain information on other Texas Instruments products and application solutions:

Products

Audio	www.ti.com/audio
Amplifiers	amplifier.ti.com
Data Converters	dataconverter.ti.com
DLP® Products	www.dlp.com
DSP	dsp.ti.com
Clocks and Timers	www.ti.com/clocks
Interface	interface.ti.com
Logic	logic.ti.com
Power Mgmt	power.ti.com
Microcontrollers	microcontroller.ti.com
RFID	www.ti-rfid.com
OMAP Mobile Processors	www.ti.com/omap
Wireless Connectivity	www.ti.com/wirelessconnectivity

Applications

Communications and Telecom	www.ti.com/communications
Computers and Peripherals	www.ti.com/computers
Consumer Electronics	www.ti.com/consumer-apps
Energy and Lighting	www.ti.com/energy
Industrial	www.ti.com/industrial
Medical	www.ti.com/medical
Security	www.ti.com/security
Space, Avionics and Defense	www.ti.com/space-avionics-defense
Transportation and Automotive	www.ti.com/automotive
Video and Imaging	www.ti.com/video

TI E2E Community Home Page

e2e.ti.com

Mailing Address: Texas Instruments, Post Office Box 655303, Dallas, Texas 75265
Copyright © 2011, Texas Instruments Incorporated