

# LM5030

## 100V Push-Pull Current Mode PWM Controller

### General Description

The LM5030 High Voltage PWM controller contains all of the features needed to implement Push-Pull and Bridge topologies, using current-mode control in a small 10 pin package. This device provides two alternating gate driver outputs. The LM5030 includes a high-voltage start-up regulator that operates over a wide input range of 14V to 100V. Additional features include: error amplifier, precision reference, dual mode current limit, slope compensation, softstart, sync capability and thermal shutdown. This high speed IC has total propagation delays less than 100ns and a 1MHz capable single resistor adjustable oscillator.

**Package:** MSOP-10 and thermally enhanced LLP-10 (4mm x 4mm).

### Features

- Internal High Voltage Start-up Regulator
- Single Resistor Oscillator Setting
- Synchronizable
- Error Amplifier
- Precision Reference
- Adjustable Softstart
- Dual Mode Over-Current Protection
- Slope Compensation
- Direct Optocoupler Interface
- 1.5A Peak Gate Drivers
- Thermal Shutdown

### Applications

- Telecommunication Power Converters
- Industrial Power Converters
- +42V Automotive Systems

### Connection Diagram

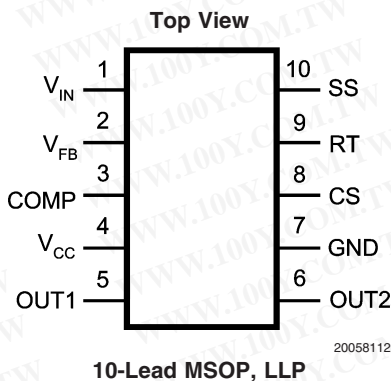

### Ordering Information

Order Number	Package Type	NSC Package Drawing	Supplies As
LM5030MM	MSOP-10	MUB10A	1000 Units on Tape and Reel
LM5030MMX	MSOP-10	MUB10A	3500 Units on Tape and Reel
LM5030SD	LLP-10	SDC10A	1000 Units on Tape and Reel
LM5030SDX	LLP-10	SDC10A	4500 Units on Tape and Reel

**勝特力材料 886-3-5753170**  
**勝特力电子(上海) 86-21-34970699**  
**勝特力电子(深圳) 86-755-83298787**  
[Http://www.100y.com.tw](http://www.100y.com.tw)

## Block Diagram

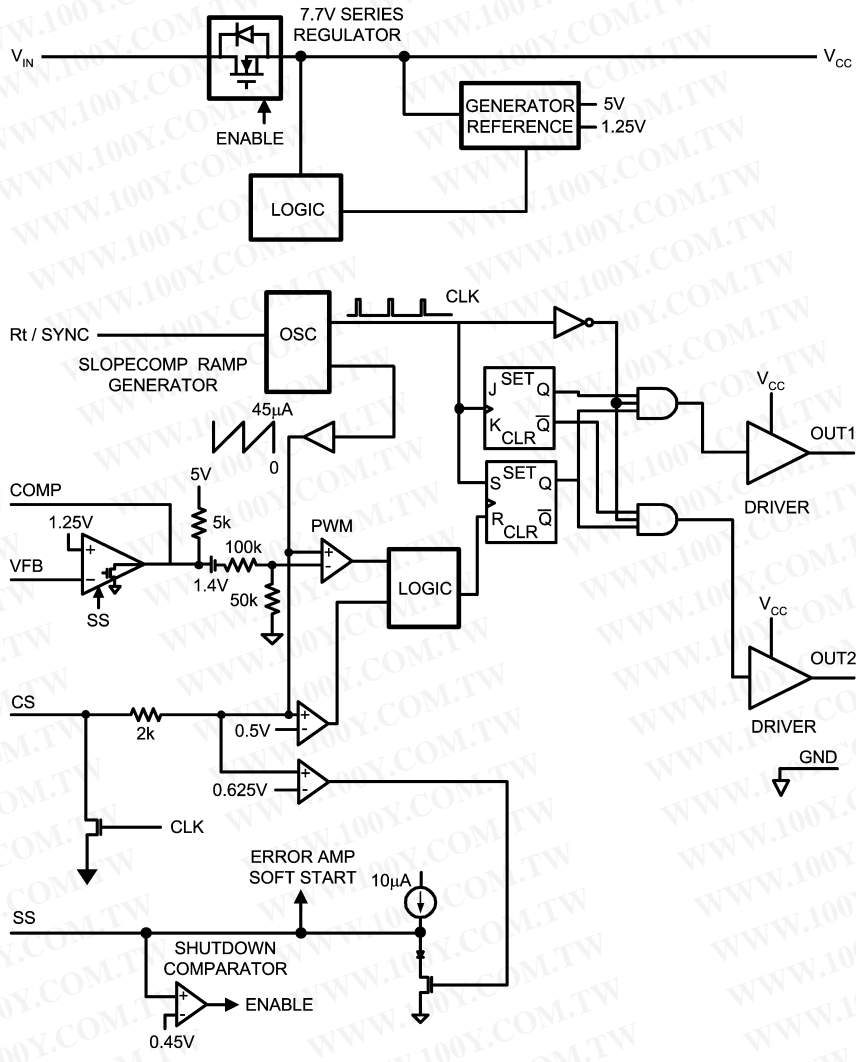

20058101

FIGURE 1.

勝特力材料 886-3-5753170  
 勝特力电子(上海) 86-21-34970699  
 勝特力电子(深圳) 86-755-83298787  
[Http://www.100y.com.tw](http://www.100y.com.tw)

## Pin Description

Pin Name	Pin Number	Description	Application Information
V <sub>IN</sub>	1	Source Input Voltage	Input to start-up regulator. Input range 14 to 100 Volts.
V <sub>FB</sub>	2	Inverting input to the error amplifier	The non-inverting input is internally connected to a 1.25 Volt reference.
COMP	3	Output to the error amplifier	There is an internal 5K resistor pull-up on this pin. The error amplifier provides an active sink.
V <sub>CC</sub>	4	Output from the internal high voltage series pass regulator. The regulation setpoint is 7.7 Volts.	If an auxiliary winding raises the voltage on this pin above the regulation setpoint the internal series pass regulator will shutdown, reducing the IC power dissipation.
OUT1	5	Output of the PWM controller	Alternating PWM output gate driver.
OUT2	6	Output of the PWM controller	Alternating PWM output gate driver.
GND	7	Return	Ground
CS	8	Current sense input	Current sense input for current mode control and current limit sensing. Using separate dedicated comparators, if CS exceeds 0.5 Volt the outputs will go into Cycle by Cycle current limit. If CS exceeds 0.625V the outputs will be disabled and a softstart commenced.
RT	9	Oscillator timing resistor pin and synchronization input.	An external resistor sets the oscillator frequency. This pin will also accept synchronization pulses from an external oscillator.
SS	10	Dual purpose Softstart and Shutdown pin	A 10 $\mu$ A current source and an external capacitor set the softstart timing length. The controller will enter a low power state if the SS pin is pulled below the typical shutdown threshold of 0.45V.
LLP DAP	SUB	Die Substrae	The exposed die attach pad on the LLP package should be connected to a PCB thermal pad at ground potential. For additional information on using National Semiconductor's No Pull Back LLP package, please refer to LLP Application Note AN-1187.

**勝特力材料 886-3-5753170**  
**勝特力电子(上海) 86-21-34970699**  
**勝特力电子(深圳) 86-755-83298787**  
**Http://www.100y.com.tw**

**Absolute Maximum Ratings** (Note 1)

If Military/Aerospace specified devices are required, please contact the National Semiconductor Sales Office/Distributors for availability and specifications.

$V_{IN}$ to GND (Survival)	-0.3V to 100V
$V_{CC}$ to GND (Survival)	-0.3V to 16V
RT to GND (Survival)	-0.3V to 5.5V
All other pins to GND (Survival)	-0.3V to 7V
Power Dissipation (Note 2)	Internally Limited
ESD Rating (Note 3)	
Human Body Model	2kV
Machine Model	200V

Lead Temperature

(Soldering 4 seconds)

260°C

Storage Temperature Range

-55°C to +150°C

Junction Temperature

150°C

**Operating Ratings**

Junction Temperature

-40°C to +105°C

 $V_{IN}$ 

14V to 90V

**Electrical Characteristics**

Specifications in standard type face are for  $T_J = +25^\circ\text{C}$  and those in **boldface type** apply over the full operating junction temperature range. Unless otherwise specified:  $V_{IN} = 48\text{V}$ ,  $V_{CC} = 10\text{V}$ , and  $RT = 26.7\text{k}\Omega$

Symbol	Parameter	Conditions	Min (Note 4)	Typ (Note 5)	Max (Note 4)	Units
<b>Startup Regulator</b>						
$V_{CCReg}$	$V_{CC}$ Regulation	open ckt	<b>7.4</b>	7.7	<b>8.0</b>	V
	$V_{CC}$ Current Limit	(Note 2)	<b>10</b>	17		mA
$I-V_{IN}$	Startup Regulator Leakage (external $V_{CC}$ Supply)	$V_{IN} = 90\text{V}$		150	<b>500</b>	$\mu\text{A}$
$I_{IN}$	Shutdown Current	$SS = 0\text{V}$ , $V_{CC} = \text{open}$		250	<b>350</b>	$\mu\text{A}$
<b><math>V_{CC}</math> Supply</b>						
	$V_{CC}$ undervoltage Lockout Voltage		<b>VccReg - 300mV</b>	VccReg - 100mV		V
	Undervoltage Hysteresis		<b>1.2</b>	1.6	<b>2.1</b>	V
$I_{CC}$	Supply Current	Clload = 0		2	<b>3</b>	mA
<b>Error Amplifier</b>						
GBW	Gain Bandwidth			4		MHz
	DC Gain			75		dB
	Input Voltage	$V_{FB} = \text{COMP}$	<b>1.220</b>	1.245	<b>1.270</b>	V
	COMP Sink Capability	$V_{FB} = 1.5\text{V}$ COMP = 1V	<b>5</b>	13		mA
<b>Current Limit</b>						
CS1	Cycle by Cycle CS Threshold Voltage		<b>0.45</b>	0.5	<b>0.55</b>	V
CS2	Restart CS Threshold Voltage	Resets SS capacitor; auto restart	<b>0.575</b>	0.625	<b>0.675</b>	V
	ILIM Delay to Output	CS step from 0 to 0.6V Time to onset of OUT Transition (90%) Clload = 0		30		ns
	CS Sink Current (clocked)	CS = 0.3V	<b>3</b>	6		mA
<b>Soft Start/Shutdown</b>						
	Softstart Current Source		<b>7</b>	10	<b>13</b>	$\mu\text{A}$
	Softstart to COMP Offset		<b>0.25</b>	0.5	<b>0.75</b>	V
	Shutdown Threshold		<b>0.2</b>	0.45	<b>0.7</b>	V

勝特力材料 886-3-5753170  
 勝特力电子(上海) 86-21-34970699  
 勝特力电子(深圳) 86-755-83298787  
[Http://www.100y.com.tw](http://www.100y.com.tw)



## Electrical Characteristics (Continued)

Specifications in standard type face are for  $T_J = +25^\circ\text{C}$  and those in **boldface type** apply over the full operating junction temperature range. Unless otherwise specified:  $V_{IN} = 48\text{V}$ ,  $V_{CC} = 10\text{V}$ , and  $R_T = 26.7\text{k}\Omega$

Symbol	Parameter	Conditions	Min (Note 4)	Typ (Note 5)	Max (Note 4)	Units
<b>Oscillator</b>						
	Frequency1 (RT = 26.7K)		<b>175</b>	200	<b>225</b>	kHz
	Frequency2 (RT = 8.2K)		<b>510</b>	600	<b>690</b>	kHz
	Sync threshold			3.2	<b>3.8</b>	V
<b>PWM Comparator</b>						
	Delay to Output	COMP set to 2V CS stepped 0 to 0.4V, Time to onset of OUT transition low		30		ns
	Max Duty Cycle	Inferred from deadtime	<b>47.5</b>	49	<b>50</b>	%
	Min Duty Cycle	COMP=0V			<b>0</b>	%
	COMP to PWM Comparator Gain			0.34		
	COMP Open Circuit Voltage	$V_{FB} = 0\text{V}$	<b>4.3</b>	5.2	<b>6.1</b>	V
	COMP Short Circuit Current	$V_{FB} = 0\text{V}$ , COMP=0V	<b>0.6</b>	1.1	<b>1.5</b>	mA
<b>Slope Compensation</b>						
	Slope Comp Amplitude	Delta increase at PWM Comparator to CS	<b>80</b>	105	<b>130</b>	mV
<b>Output Section</b>						
	Deadtime	Cload = 0, 10% to 10%	<b>85</b>	135	<b>185</b>	ns
	Output High Saturation	$I_{OUT} = 50\text{mA}$ , $V_{CC} - V_{OUT}$		0.25	<b>0.75</b>	V
	Output Low Saturation	$I_{OUT} = 100\text{mA}$		0.25	<b>0.75</b>	V
	Rise Time	Cload = 1nF		16		ns
	Fall Time	Cload = 1nF		16		ns
<b>Thermal Shutdown</b>						
Tsd	Thermal Shutdown Temp.			165		$^\circ\text{C}$
	Thermal Shutdown Hysteresis			15		$^\circ\text{C}$

**Note 1:** Absolute Maximum Ratings are limits beyond which damage to the device may occur. Operating Ratings are conditions under which operation of the device is intended to be functional. For guaranteed specifications and test conditions, see the Electrical Characteristics.

**Note 2:** The maximum allowable power dissipation is a function of the maximum junction temperature,  $T_{J(\text{MAX})}$ , the junction-to-ambient thermal resistance,  $\theta_{JA}$ , and the ambient temperature,  $T_A$ . The maximum allowable power dissipation at any ambient temperature is calculated using:

$$P_{D(\text{MAX})} = \frac{T_{J(\text{MAX})} - T_A}{\theta_{JA}}$$

Where the value of  $\theta_{JA}$  for the mini SO-10 (MM) package is  $200^\circ\text{C/W}$ . Exceeding the maximum allowable dissipation will cause excessive die temperature, and the device will go into thermal shutdown.

**Note 3:** The human body model is a 100pF capacitor discharged through a 1.5k $\Omega$  resistor into each pin. The machine model is a 200pF capacitor discharged directly into each pin. The machine model ESD rating for pin 5 and pin 6 is 150V.

**Note 4:** Limits are 100% production tested at  $25^\circ\text{C}$ . Limits over the operating temperature range are guaranteed through correlation using Statistical Quality Control (SQC) methods. The limits are used to calculate National's Average Outgoing Quality Level (AOQL).

**Note 5:** Typical numbers represent the most likely parametric norm for  $25^\circ\text{C}$  operation.

勝特力材料 886-3-5753170  
 勝特力电子(上海) 86-21-34970699  
 勝特力电子(深圳) 86-755-83298787  
[Http://www.100y.com.tw](http://www.100y.com.tw)

**Typical Performance Characteristics** Unless otherwise specified:  $T_J = 25^\circ\text{C}$ .

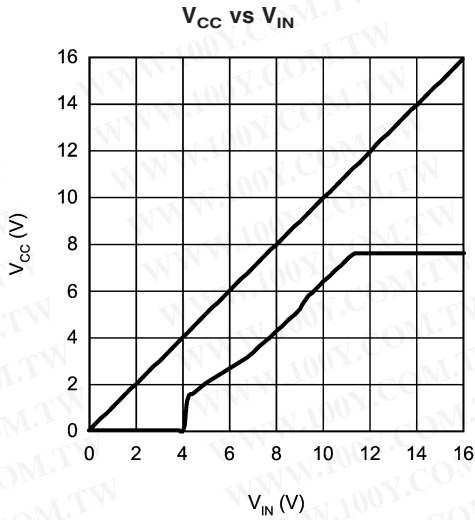

20058105

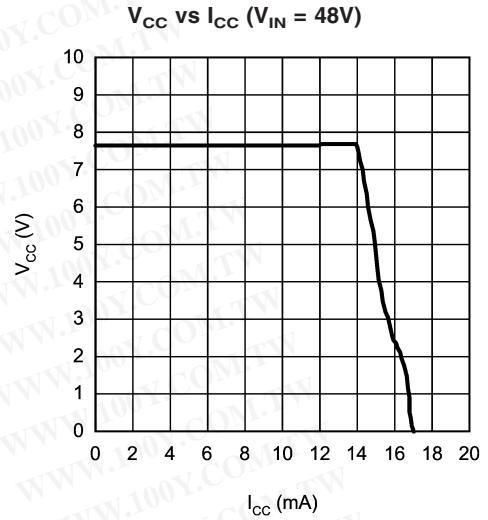

20058107

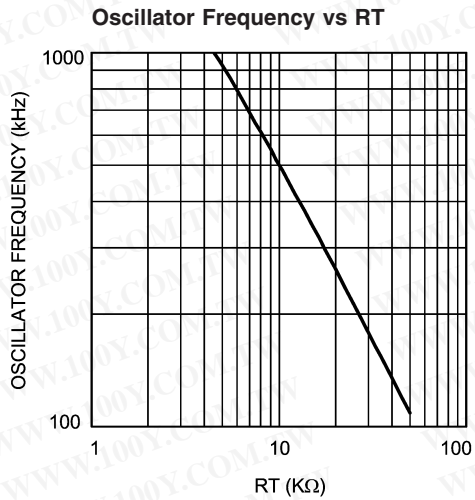

20058108

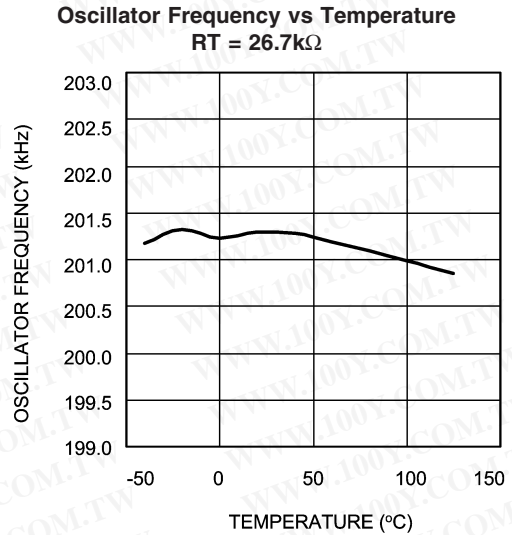

20058109

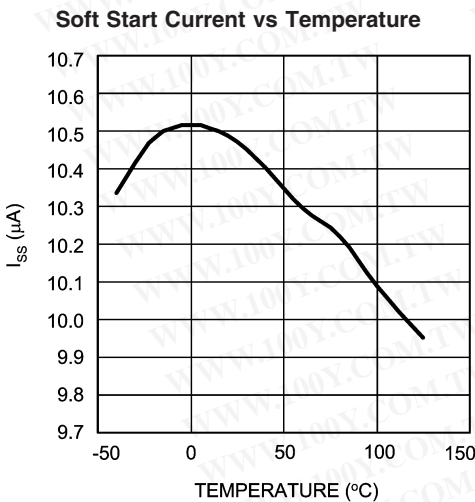

20058110

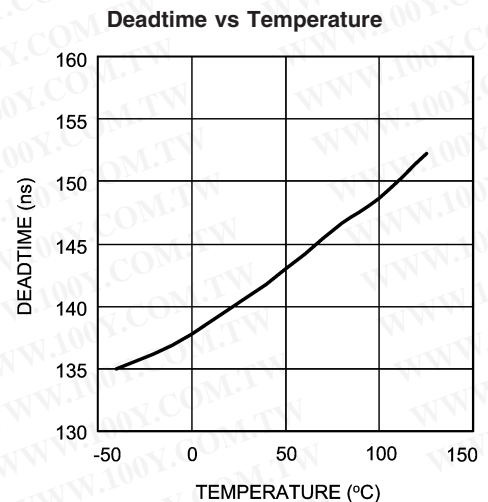

20058111

勝特力材料 886-3-5753170  
 勝特力电子(上海) 86-21-34970699  
 勝特力电子(深圳) 86-755-83298787  
[Http://www.100y.com.tw](http://www.100y.com.tw)

## Typical Performance Characteristics

Unless otherwise specified:  $T_J = 25^\circ\text{C}$ . (Continued)

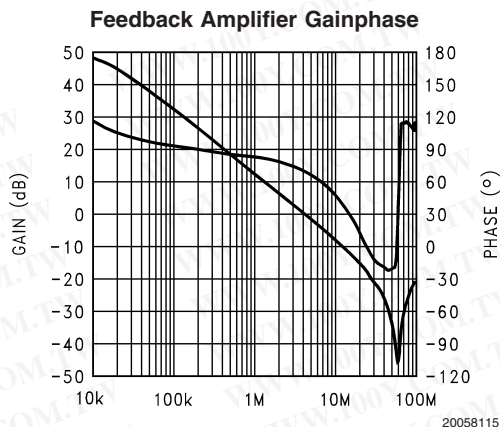

勝特力材料 886-3-5753170  
 勝特力电子(上海) 86-21-34970699  
 勝特力电子(深圳) 86-755-83298787  
[Http://www.100y.com.tw](http://www.100y.com.tw)

### Detailed Operating Description

The LM5030 High Voltage PWM controller contains all of the features needed to implement Push-Pull and Bridge topologies, using current-mode control in a small 10 pin package. Features included are, startup regulator, dual mode current limit, dual alternating gate drivers, thermal shutdown, soft-start and slope compensation. This high speed IC has total propagation delays  $<100\text{nS}$ . The Functional Block Diagram of the LM5030 is shown in *Figure 1*.

The LM5030 is designed for Current-Mode Control converters which require alternating outputs, such as Push-Pull and Half/Full Bridge topologies. The features included in the LM5030 enable all of the advantages of Current-Mode Control, line feed-forward, cycle by cycle current limit and simplified loop compensation. The oscillator ramp is internally buffered and added to the PWM comparator input to provide slope compensation necessary for current mode control at higher duty cycles.

### High Voltage Start-Up Regulator

The LM5030 contains an internal high voltage startup regulator. The input pin ( $V_{in}$ ) can be connected directly to line voltages as high as 100V. The regulator output is internally current limited to 10mA. Upon power up, the regulator is enabled and sources current into an external capacitor connected to the  $V_{CC}$  pin. The recommended capacitance range for the  $V_{CC}$  regulator is 0.1 $\mu\text{F}$  to 50 $\mu\text{F}$ . When the voltage on the  $V_{CC}$  pin reaches the regulation point of 7.7V, the controller outputs are enabled. The outputs will remain enabled unless,  $V_{CC}$  falls below 6.1V or if the SS/SHUTDOWN pin is pulled to ground or an over temperature condition occurs. In typical applications, an auxiliary transformer winding is diode connected to the  $V_{CC}$  pin. This winding raises the  $V_{CC}$  voltage greater than 8V, effectively shutting off the internal startup regulator and saving power while reducing the controller dissipation. The external  $V_{CC}$  capacitor must be sized such that the self-bias will maintain a  $V_{CC}$  voltage greater than 6.1V during the initial start-up. During a fault mode when the converter self bias winding is inactive, external current draw on the  $V_{CC}$  line should be limited as to not exceed the maximum power dissipation of the controller. An external start-up or other bias rail can be used instead of the internal start-up regulator by connecting the  $V_{CC}$  and the  $V_{in}$  pins and feeding the external bias voltage (8 - 15V) to that node.

### Error Amplifier

An internal high gain error amplifier is provided within the LM5030. The amplifier's non-inverting reference is tied to 1.25V. In non-isolated applications the power converter output is connected to the VFB pin via the voltage setting resistors and loop compensation is connected between the COMP and VFB pins.

For most isolated applications the error amplifier function is implemented on the secondary side ground. Since the internal error amplifier is configured as an open drain output it can be disabled by connecting VFB to ground. The internal 5K pull-up resistor, connected between the 5V reference and COMP, can be used as the pull-up for an optocoupler or other isolation device.

### PWM Comparator

The PWM comparator compares the compensated current ramp signal to the loop error voltage from the internal error amplifier (COMP pin). This comparator is optimized for speed in order to achieve minimum discernable duty cycles. The comparator polarity is such that zero Volts on the COMP pin will cause a zero duty cycle.

### Current Limit/ Current Sense

The LM5030 contains two levels of over-current protection. If the voltage on the current sense comparator exceeds 0.5 Volts the present cycle is terminated (cycle by cycle current limit). If the voltage on the current sense comparator exceeds 0.625 Volts, the controller will terminate the present cycle and discharge the softstart capacitor. A small RC filter, located near the controller, is recommended for the CS pin. An internal MOSFET discharges the current sense filter capacitor at the conclusion of every cycle, to improve dynamic performance.

The LM5030 CS and PWM comparators are very fast, and as such will respond to short duration noise pulses. Layout considerations are critical for the current sense filter and sense resistor. The capacitor associated with the CS filter must be placed very close to the device and connected directly to the pins of the IC (CS and RTN). Also if a current sense transformer is used, both leads of the transformer secondary should be routed to the sense resistor, which should also be located close to the IC. If a current sense resistor located in the drive transistor sources is used, for current sense, a low inductance resistor should be chosen.



## Current Limit/ Current Sense

(Continued)

In this case all of the noise sensitive low power grounds should be commoned together around the IC and then a single connection should be made to the power ground (sense resistor ground point).

The second level threshold is intended to protect the power converter by initiating a low duty cycle hiccup mode when abnormally high, fast rising currents occur. During excessive loading, the first level threshold will always be reached and the output characteristic of the converter will be that of a current source but this sustained current level can cause excessive temperatures in the power train especially the output rectifiers. If the second level threshold is reached, the softstart capacitor will be fully discharged, a retry will commence following the discharge detection. The second level threshold will only be reached when a high  $dV/dt$  is present at the current sense pin. The signal must be fast enough to reach the second level threshold before the first threshold detector turns off the driver. This can usually happen for a saturated power inductor or shorted load. Excessive filtering on the CS pin, extremely low value current sense resistor or an inductor that does not saturate with excessive loading may prevent the second level threshold from ever being reached.

## Oscillator, Shutdown and Sync Capability

The LM5030 oscillator is set by a single external resistor connected between the RT pin and return. To set a desired oscillator frequency the necessary RT resistor can be calculated as:

$$RT = \frac{(1/F) - 172 \times 10^{-9}}{182 \times 10^{-12}}$$

Each output switches at half the oscillator frequency in a Push-Pull configuration. The LM5030 can also be synchronized to an external clock. The external clock must be of higher frequency than the free running frequency set by the RT resistor. The clock signal should be capacitively coupled into the RT pin with a 100pF capacitor. A peak voltage level greater than 3 Volts with respect to ground is required for detection of the sync pulse. The sync pulse width should be set in the 15 to 150ns range by the external components. The RT resistor is always required, whether the oscillator is free running or externally synchronized. The voltage at the RT pin is internally regulated to a nominal 2 Volts.

The RT resistor should be located very close to the device and connected directly to the pins of the IC (RT and GND).

## Slope Compensation

The PWM comparator compares the current sense signal to the voltage derived from the COMP pin. The COMP voltage is set by either the internal error amplifier or an external error amplifier through an optocoupler. At duty cycles greater than 50% (composite of alternating outputs) current mode control circuits are prone to subharmonic oscillation. By adding an additional ramp signal to the current sense ramp signal this condition can be avoided. The LM5030 integrates this slope compensation by buffering the internal oscillator ramp and summing it internally to the current sense (CS) signal. Additional slope compensation may be added by increasing the source impedance of the current sense signal.

## Soft Start/ Shutdown

The softstart feature allows the converter to gradually reach the initial steady state operating point, thus reducing start-up stresses and surges. An internal 10uA current source and an external capacitor generate a ramping voltage signal which limits the error amplifier output during start-up. In the event of a second level current limit fault, the softstart capacitor will be fully discharged which disables the output drivers. When the fault condition is no longer present, the softstart capacitor is released to ramp and gradually restart the converter. The SS pin can also be used to disable the controller. If the SS pin voltage is pulled down below 0.45V (nominal) the controller will disable the outputs and enter a low power state.

## OUT1, OUT2 and Time Delay

The LM5030 provides two alternating outputs, OUT1 and OUT2. The internal gate drivers can each sink 1.5A peak each. The maximum duty cycle for each output is inherently limited to less than 50%. The typical deadtime between the falling edge of one gate driver output and the rising edge of the other gate driver output is 135ns.

## Thermal Protection

Internal Thermal Shutdown circuitry is provided to protect the integrated circuit in the event the excessive junction temperature. When activated, typically at 165 degrees Celsius, the controller is forced into a low power reset state, disabling the output drivers and the bias regulator. This feature is provided to prevent catastrophic failures from accidental device overheating.

勝特力材料 886-3-5753170  
 勝特力电子(上海) 86-21-34970699  
 勝特力电子(深圳) 86-755-83298787  
[Http://www.100y.com.tw](http://www.100y.com.tw)





ITEM	PART NUMBER	DESCRIPTION	VALUE	
C	1	C0805C472K5RAC	Capacitor, CER, KEMET	4700p, 50V
C	2	C0805C103K5RAC	Capacitor, CER, KEMET	0.01μ, 50V
C	3	C4532X7S0G686M	Capacitor, CER, TDK	68μ, 4V
C	4	T520D337M006AS4350	Capacitor, TANT, KEMET	330μ, 6.3V
C	5	T520D337M006AS4350	Capacitor, TANT, KEMET	330μ, 6.3V
C	6	C4532X7R3A103K	Capacitor, CER, TDK	0.01μ, 1000V
C	7	C3216X7R2A104K	Capacitor, CER, TDK	0.1μ, 100V
C	8	C4532X7R2A105M	Capacitor, CER, TDK	1μ, 100V
C	9	C4532X7R2A105M	Capacitor, CER, TDK	1μ, 100V
C	10	C0805C102K1RAC	Capacitor, CER, KEMET	1000p, 100V
C	11	C1206C223K5RAC	Capacitor, CER, KEMET	0.022μ, 50V
C	12	C3216X7R1E105M	Capacitor, CER, TDK	1μ, 25V
C	13	C3216COG2J221J	Capacitor, CER, TDK	220p, 630V
C	14	C3216COG2J221J	Capacitor, CER, TDK	220p, 630V
C	15	C1206C104K5RAC	Capacitor, CER, KEMET	0.1μ, 50V
C	16	C0805C101J1GAC	Capacitor, CER, KEMET	100p, 100V
C	17	C0805C101J1GAC	Capacitor, CER, KEMET	100p, 100V
C	18	C3216X7R1H334K	Capacitor, CER, TDK	0.33μ, 50μ
D	1	MBRB3030CTL	Diode, Schottky, ON	
D	2	CMPD2838-NSA	Diode, Signal, Central	
D	3	CMPD2838-NSA	Diode, Signal, Central	
D	4	CMPD2838-NSA	Diode, Signal, Central	
D	5	CMPD2838-NSA	Diode, Signal, Central	
L	1	MSS6132-103	Input Choke, Coilcraft	10μH, 1.5A
L	2	A9785-B	Output Choke, Coilcraft	7μH
R	1	CRCW12061R00F	Resistor	1
R	2	CRCW12064990F	Resistor	499
R	3	CRCW2512101J	Resistor	100, 1W
R	4	CRCW2512101J	Resistor	100, 1W
R	5	CRCW12064022F	Resistor	40.2K
R	6	CRCW120610R0F	Resistor	10
R	7	CRCW120610R0F	Resistor	10
R	8	CRCW12061002F	Resistor	10K
R	9	CRCW120623R7F	Resistor	23.7
R	10	CRCW12062002F	Resistor	20K
R	11	CRCW120610R0F	Resistor	10
R	12	CRCW12063010F	Resistor	301
R	13	CRCW120610R0F	Resistor	10
R	14	CRCW12061001F	Resistor	1K
TX	1	A9784-B	POWER XFR, COILCRAFT	
TX	2	P8208T	CURRENT XFR, Pulse	100:1
U1	1	LM5030	REGULATOR, NATIONAL	
U2	2	MOCD207M	OPTO-COUPLER, QT OPTOELECTRONICS	
U3	3	LM3411AM5-3.3	REFERENCE, NATIONAL	
		651-1727010	DUAL TERMINALS, MOUSER	3 per ASSY
X	1	SUD19N20-90	FET, N, 200V, SILICONIX	
X	2	SUD19N20-90	FET, N, 200V, SILICONIX	

勝特力材料 886-3-5753170  
 勝特力电子(上海) 86-21-34970699  
 勝特力电子(深圳) 86-755-83298787  
[Http://www.100y.com.tw](http://www.100y.com.tw)

# Physical Dimensions inches (millimeters)

unless otherwise noted

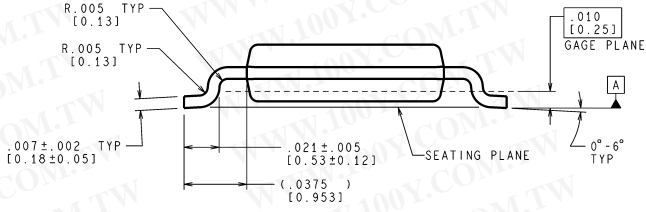
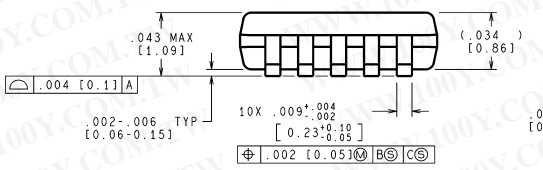
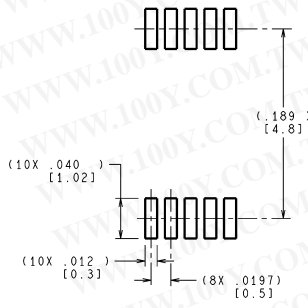
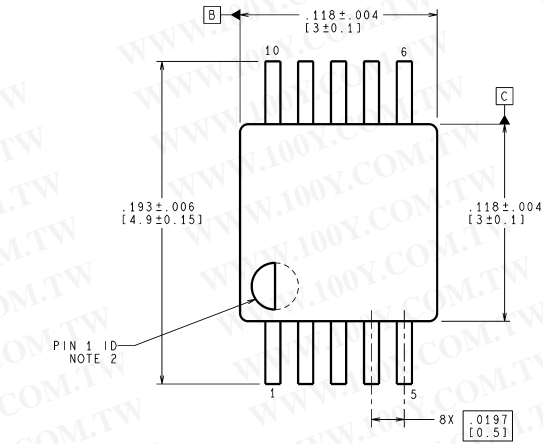

CONTROLLING DIMENSION IS INCH  
VALUES IN [ ] ARE MILLIMETERS  
DIMENSIONS IN ( ) FOR REFERENCE ONLY

MUB10A (Rev B)

## 10 Lead MSOP Package NS Package Number MUB10A

勝特力材料 886-3-5753170  
 勝特力电子(上海) 86-21-34970699  
 勝特力电子(深圳) 86-755-83298787  
[Http://www.100y.com.tw](http://www.100y.com.tw)

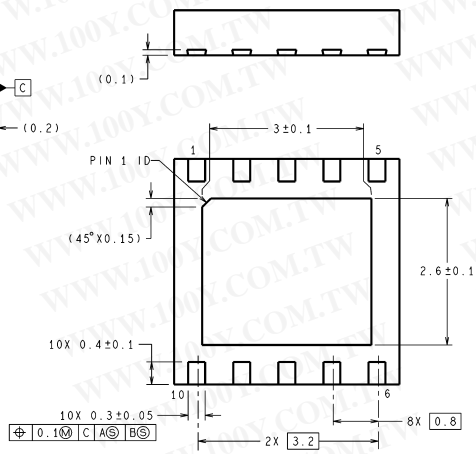
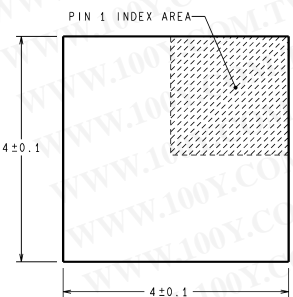
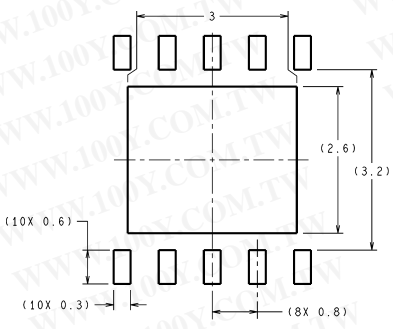

DIMENSIONS ARE IN MILLIMETERS

SDC10A (Rev A)

## 10 Lead LLP Package NS Package Number SDC10A