

AN7900T/AN7900F Series

3-pin Negative Output Voltage Regulators (1A Type)

Overview

The AN7900T/AN7900F series is 3-pin fixed negative output type monolithic voltage regulators. A stabilized fixed negative output voltage is obtained from an unstable DC input voltage without using any external parts. Eleven types of fixed output voltage are available from $-5V$ through $-10V$, $-12V$, $-15V$, $-18V$, $-20V$, and $-24V$. They can be used widely as power circuits with a current capacitance of up to 1A.

Features

- No external components
- Output voltage : $-5V$, $-6V$, $-7V$, $-8V$, $-9V$, $-10V$, $-12V$, $-15V$, $-18V$, $-20V$, $-24V$
- Overcurrent limit circuit built-in
- Thermal over-load protection built-in
- Area of safe operation (ASO) circuit built-in

勝特力材料 886-3-5753170
勝特力电子(上海) 86-21-34970699
勝特力电子(深圳) 86-755-83298787
[Http://www.100y.com.tw](http://www.100y.com.tw)

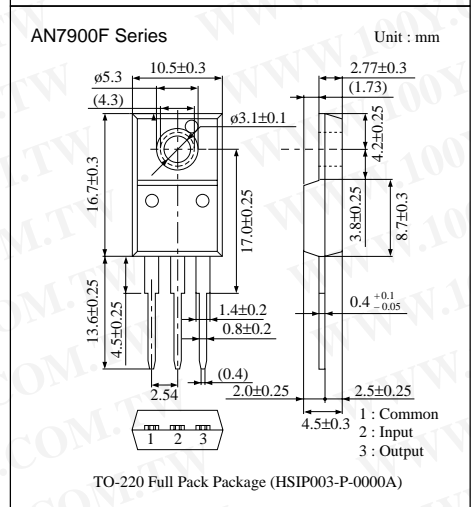
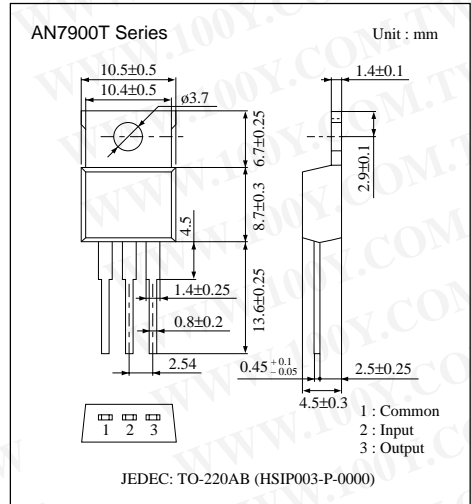

Block Diagram

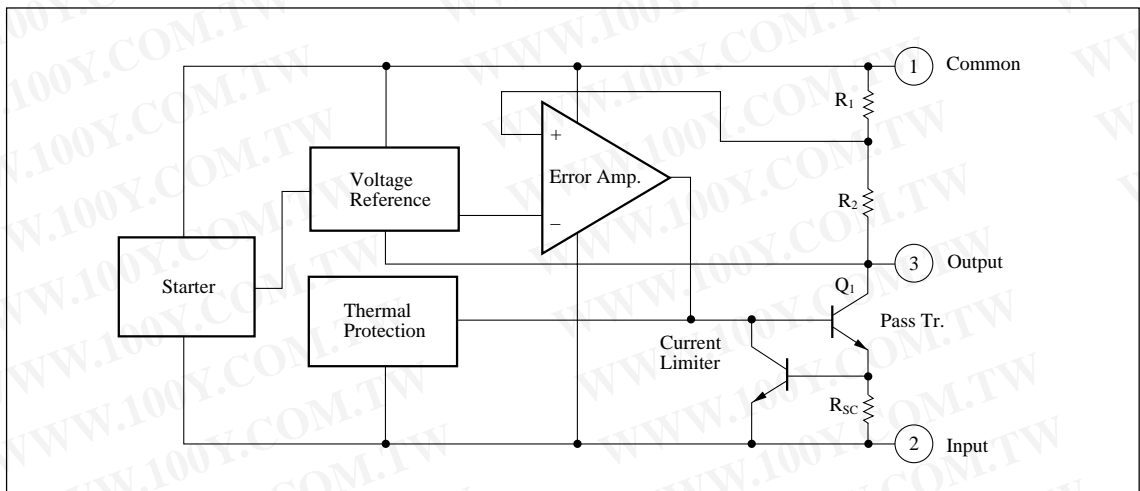

■ Absolute Maximum Ratings (Ta=25°C)

| Parameter | | Symbol | Rating | Unit |
|-------------------------------|----------------|------------------|-------------|------|
| Input voltage | | V _i | -35 *1 | V |
| | | | -40 *2 | V |
| Power dissipation | AN7900T Series | P _D | 15 *3 | W |
| | AN7900F Series | | 10.25 *3 | |
| Operating ambient temperature | | T _{opr} | -30 to +80 | °C |
| Storage temperature | | T _{stg} | -55 to +150 | °C |

*1 AN7905T/F, AN7906T/F, AN7907T/F, AN7908T/F, AN7909T/F, AN7910T/F, AN7912T/F, AN7915T/F, AN7918T/F

*2 AN7920T/F, AN7924T/F

*3 Follow the derating curve. When T_j exceeds 150°C, the internal circuit shuts off the output.

■ Electrical Characteristics (Ta=25°C)

• AN7905T/AN7905F (-5V Type)

| Parameter | Symbol | Condition | min | typ | max | Unit |
|--|-------------------------|---|-------|------|-------|-------|
| Output voltage | V _O | T _j =25°C | -4.8 | -5 | -5.2 | V |
| Output voltage tolerance | V _O | V _i =-7 to -20V, I _O =5mA to 1A, P _D ≤* | -4.75 | — | -5.25 | V |
| Line regulation | REG _{IN} | V _i =-7 to -25V, T _j =25°C | — | 3 | 100 | mV |
| | | V _i =-8 to -12V, T _j =25°C | — | 1 | 50 | mV |
| Load regulation | REG _L | I _O =5mA to 1.5A, T _j =25°C | — | 10 | 100 | mV |
| | | I _O =250 to 750mA, T _j =25°C | — | 3 | 50 | mV |
| Bias current | I _{bias} | T _j =25°C | — | 2 | 4 | mA |
| Input bias fluctuation | ΔI _{bias (IN)} | V _i =-7 to -25V, T _j =25°C | — | — | 1.3 | mA |
| Load bias current fluctuation | ΔI _{bias (L)} | I _O =5mA to 1A, T _j =25°C | — | — | 0.5 | mA |
| Output noise voltage | V _{no} | f=10Hz to 100kHz, Ta=25°C | — | 40 | — | μV |
| Ripple rejection ratio | RR | V _i =-8 to -18V, I _O =100mA, f=120Hz | 62 | 74 | — | dB |
| Minimum i/o voltage difference | V _{DIF (min.)} | I _O =1A, T _j =25°C | — | 1.1 | — | V |
| Peak output current | I _{O (Peak)} | T _j =25°C | — | 2.1 | — | A |
| Output voltage temperature coefficient | ΔV _O /Ta | I _O =5mA, T _j =0 to 125°C | — | -0.4 | — | mV/°C |

Note 1) The specified condition T_j=25°C means that the test should be carried out with the test time so short (within 10ms) that the drift in characteristic value due to the rise in chip junction temperature can be ignored.

Note 2) Unless otherwise specified, V_i=-10V, I_O=500mA, C_i=2μF, C_O=1μF, T_j=0 to 125°C

* AN7900T series : 15W, AN7900F series : 10.25W

勝特力材料 886-3-5753170
 勝特力电子(上海) 86-21-34970699
 勝特力电子(深圳) 86-755-83298787
[Http://www.100y.com.tw](http://www.100y.com.tw)

■ Electrical Characteristics (Ta=25°C) (continued)

• AN7906T/AN7906F (-6V Type)

| Parameter | Symbol | Condition | min | typ | max | Unit |
|--|-------------------------|---|-------|------|-------|-------|
| Output voltage | V _O | T _J =25°C | -5.75 | -6 | -6.25 | V |
| Output voltage tolerance | V _O | V _I =-8 to -21V, I _O =5mA to 1A, P _D ≤* | -5.7 | — | -6.3 | V |
| Line regulation | REG _{IN} | V _I =-8 to -25V, T _J =25°C | — | 4 | 120 | mV |
| | | V _I =-9 to -13V, T _J =25°C | — | 1.5 | 60 | mV |
| Load regulation | REG _L | I _O =5mA to 1.5A, T _J =25°C | — | 10 | 120 | mV |
| | | I _O =250 to 750mA, T _J =25°C | — | 3 | 60 | mV |
| Bias current | I _{bias} | T _J =25°C | — | 2 | 4 | mA |
| Input bias fluctuation | ΔI _{bias (IN)} | V _I =-8 to -25V, T _J =25°C | — | — | 1.3 | mA |
| Load bias current fluctuation | ΔI _{bias (L)} | I _O =5mA to 1A, T _J =25°C | — | — | 0.5 | mA |
| Output noise voltage | V _{no} | f=10Hz to 100kHz, Ta=25°C | — | 44 | — | μV |
| Ripple rejection ratio | RR | V _I =-9 to -19V, I _O =100mA, f=120Hz | 60 | 73 | — | dB |
| Minimum i/o voltage difference | V _{DIF (min.)} | I _O =1A, T _J =25°C | — | 1.1 | — | V |
| Peak output current | I _{O (Peak)} | T _J =25°C | — | 2.1 | — | A |
| Output voltage temperature coefficient | ΔV _O /Ta | I _O =5mA, T _J =0 to 125°C | — | -0.5 | — | mV/°C |

Note 1) The specified condition T_J=25°C means that the test should be carried out with the test time so short (within 10ms) that the drift in characteristic value due to the rise in chip junction temperature can be ignored.

Note 2) Unless otherwise specified, V_I=-11V, I_O=500mA, C_I=2μF, C_O=1μF, T_J=0 to 125°C

* AN7900T series : 15W, AN7900F series : 10.25W

• AN7907T/AN7907F (-7V Type)

| Parameter | Symbol | Condition | min | typ | max | Unit |
|---|-------------------------|--|-------|------|-------|-------|
| Output voltage | V _O | T _J =25°C | -6.7 | -7 | -7.3 | V |
| Output voltage tolerance | V _O | V _I =-79 to -22V, I _O =5mA to 1A, P _D ≤* | -6.65 | — | -7.35 | V |
| Line regulation | REG _{IN} | V _I =-9 to -25V, T _J =25°C | — | 5 | 140 | mV |
| | | V _I =-10 to -14V, T _J =25°C | — | 1.5 | 70 | mV |
| Load regulation | REG _L | I _O =5mA to 1.5A, T _J =25°C | — | 12 | 140 | mV |
| | | I _O =250 to 750mA, T _J =25°C | — | 4 | 70 | mV |
| Bias current | I _{bias} | T _J =25°C | — | 2 | 4 | mA |
| Input bias fluctuation | ΔI _{bias (IN)} | V _I =-9 to -25V, T _J =25°C | — | — | 1.3 | mA |
| Load bias current fluctuation | ΔI _{bias (L)} | I _O =5mA to 1A, T _J =25°C | — | — | 0.5 | mA |
| Output noise voltage | V _{no} | f=10Hz to 100kHz, Ta=25°C | — | 48 | — | μV |
| Ripple rejection ratio | RR | V _I =-10 to -20V, I _O =100mA, f=120Hz | 58 | 72 | — | dB |
| Minimum input/output voltage difference | V _{DIF (min.)} | I _O =1A, T _J =25°C | — | 1.1 | — | V |
| Peak output current | I _{O (Peak)} | T _J =25°C | — | 2.1 | — | A |
| Output voltage temperature coefficient | ΔV _O /Ta | I _O =5mA, T _J =0 to 125°C | — | -0.5 | — | mV/°C |

Note 1) The specified condition T_J=25°C means that the test should be carried out with the test time so short (within 10ms) that the drift in characteristic value due to the rise in chip junction temperature can be ignored.

Note 2) Unless otherwise specified, V_I=-12V, I_O=500mA, C_I=2μF, C_O=1μF, T_J=0 to 125°C

* AN7900T series : 15W, AN7900F series : 10.25W

勝特力材料 886-3-5753170
勝特力电子(上海) 86-21-34970699
勝特力电子(深圳) 86-755-83298787
[Http://www.100y.com.tw](http://www.100y.com.tw)

■ Electrical Characteristics (Ta=25°C) (continued)

• AN7908T/AN7908F (–8V Type)

| Parameter | Symbol | Condition | min | typ | max | Unit |
|---|-------------------------|--|------|------|------|-------|
| Output voltage | V _O | T _J =25°C | –7.7 | –8 | –8.3 | V |
| Output voltage tolerance | V _O | V _I =–10 to –23V, I _O =5mA to 1A, P _D ≤* | –7.6 | — | –8.4 | V |
| Line regulation | REG _{IN} | V _I =–10.5 to –25V, T _J =25°C | — | 6 | 160 | mV |
| | | V _I =–11 to –17V, T _J =25°C | — | 2 | 80 | mV |
| Load regulation | REG _L | I _O =5mA to 1.5A, T _J =25°C | — | 12 | 160 | mV |
| | | I _O =250 to 750mA, T _J =25°C | — | 4 | 80 | mV |
| Bias current | I _{bias} | T _J =25°C | — | 2.2 | 4.5 | mA |
| Input bias fluctuation | ΔI _{bias (IN)} | V _I =–10.5 to –25V, T _J =25°C | — | — | 1 | mA |
| Load bias current fluctuation | ΔI _{bias (L)} | I _O =5mA to 1A, T _J =25°C | — | — | 0.5 | mA |
| Output noise voltage | V _{no} | f=10Hz to 100kHz, Ta=25°C | — | 52 | — | μV |
| Ripple rejection ratio | RR | V _I =–11 to –21V, I _O =100mA, f=120Hz | 56 | 71 | — | dB |
| Minimum input/output voltage difference | V _{DIF (min.)} | I _O =1A, T _J =25°C | — | 1.1 | — | V |
| Peak output current | I _{O (Peak)} | T _J =25°C | — | 2.1 | — | A |
| Output voltage temperature coefficient | ΔV _O /Ta | I _O =5mA, T _J =0 to 125°C | — | –0.6 | — | mV/°C |

Note 1) The specified condition T_J=25°C means that the test should be carried out with the test time so short (within 10ms) that the drift in characteristic value due to the rise in chip junction temperature can be ignored.

Note 2) Unless otherwise specified, V_I=–14V, I_O=500mA, C_I=2μF, C_O=1μF, T_J=0 to 125°C

* AN7900T series : 15W, AN7900F series : 10.25W

• AN7909T/AN7909F (–9V Type)

| Parameter | Symbol | Condition | min | typ | max | Unit |
|---|-------------------------|--|-------|------|-------|-------|
| Output voltage | V _O | T _J =25°C | –8.65 | –9 | –9.35 | V |
| Output voltage tolerance | V _O | V _I =–11.5 to –24V, I _O =5mA to 1A, P _D ≤* | –8.55 | — | –9.45 | V |
| Line regulation | REG _{IN} | V _I =–11.5 to –26V, T _J =25°C | — | 7 | 180 | mV |
| | | V _I =–12 to –18V, T _J =25°C | — | 2 | 90 | mV |
| Load regulation | REG _L | I _O =5mA to 1.5A, T _J =25°C | — | 12 | 180 | mV |
| | | I _O =250 to 750mA, T _J =25°C | — | 4 | 90 | mV |
| Bias current | I _{bias} | T _J =25°C | — | 2.2 | 4.5 | mA |
| Input bias fluctuation | ΔI _{bias (IN)} | V _I =–11.5 to –26V, T _J =25°C | — | — | 1 | mA |
| Load bias current fluctuation | ΔI _{bias (L)} | I _O =5mA to 1A, T _J =25°C | — | — | 0.5 | mA |
| Output noise voltage | V _{no} | f=10Hz to 100kHz, Ta=25°C | — | 58 | — | μV |
| Ripple rejection ratio | RR | V _I =–12 to –22V, I _O =100mA, f=120Hz | 56 | 71 | — | dB |
| Minimum input/output voltage difference | V _{DIF (min.)} | I _O =1A, T _J =25°C | — | 1.1 | — | V |
| Peak output current | I _{O (Peak)} | T _J =25°C | — | 2.1 | — | A |
| Output voltage temperature coefficient | ΔV _O /Ta | I _O =5mA, T _J =0 to 125°C | — | –0.6 | — | mV/°C |

Note 1) The specified condition T_J=25°C means that the test should be carried out with the test time so short (within 10ms) that the drift in characteristic value due to the rise in chip junction temperature can be ignored.

Note 2) Unless otherwise specified, V_I=–15V, I_O=500mA, C_I=2μF, C_O=1μF, T_J=0 to 125°C

* AN7900T series : 15W, AN7900F series : 10.25W

勝特力材料 886-3-5753170
 勝特力电子(上海) 86-21-34970699
 勝特力电子(深圳) 86-755-83298787
[Http://www.100y.com.tw](http://www.100y.com.tw)

■ Electrical Characteristics (Ta=25°C) (continued)

• AN7910T/AN7910F (-10V Type)

| Parameter | Symbol | Condition | min | typ | max | Unit |
|---|-------------------------|--|------|------|-------|-------|
| Output voltage | V _O | T _J =25°C | -9.6 | -10 | -10.4 | V |
| Output voltage tolerance | V _O | V _I =-12.5 to -25V, I _O =5mA to 1A, P _D ≤* | -9.5 | — | -10.5 | V |
| Line regulation | REG _{IN} | V _I =-12.5 to -27V, T _J =25°C | — | 8 | 200 | mV |
| | | V _I =-13 to -19V, T _J =25°C | — | 2.5 | 100 | mV |
| Load regulation | REG _L | I _O =5mA to 1.5A, T _J =25°C | — | 12 | 200 | mV |
| | | I _O =250 to 750mA, T _J =25°C | — | 4 | 100 | mV |
| Bias current | I _{bias} | T _J =25°C | — | 2.5 | 5 | mA |
| Input bias fluctuation | ΔI _{bias (IN)} | V _I =-12.5 to -27V, T _J =25°C | — | — | 1 | mA |
| Load bias current fluctuation | ΔI _{bias (L)} | I _O =5mA to 1A, T _J =25°C | — | — | 0.5 | mA |
| Output noise voltage | V _{no} | f=10Hz to 100kHz, Ta=25°C | — | 64 | — | μV |
| Ripple rejection ratio | RR | V _I =-13 to -23V, I _O =100mA, f=120Hz | 56 | 71 | — | dB |
| Minimum input/output voltage difference | V _{DIF (min.)} | I _O =1A, T _J =25°C | — | 1.1 | — | V |
| Peak output current | I _{O (Peak)} | T _J =25°C | — | 2.1 | — | A |
| Output voltage temperature coefficient | ΔV _O /Ta | I _O =5mA, T _J =0 to 125°C | — | -0.7 | — | mV/°C |

Note 1) The specified condition T_J=25°C means that the test should be carried out with the test time so short (within 10ms) that the drift in characteristic value due to the rise in chip junction temperature can be ignored.

Note 2) Unless otherwise specified, V_I=-16V, I_O=500mA, C_I=2μF, C_O=1μF, T_J=0 to 125°C

* AN7900T series : 15W, AN7900F series : 10.25W

• AN7912T/AN7912F (-12V Type)

| Parameter | Symbol | Condition | min | typ | max | Unit |
|---|-------------------------|--|-------|------|-------|-------|
| Output voltage | V _O | T _J =25°C | -11.5 | -12 | -12.5 | V |
| Output voltage tolerance | V _O | V _I =-14.5 to -27V, I _O =5mA to 1A, P _D ≤* | -11.4 | — | -12.6 | V |
| Line regulation | REG _{IN} | V _I =-14.5 to -30V, T _J =25°C | — | 10 | 240 | mV |
| | | V _I =-16 to -22V, T _J =25°C | — | 3 | 120 | mV |
| Load regulation | REG _L | I _O =5mA to 1.5A, T _J =25°C | — | 12 | 240 | mV |
| | | I _O =250 to 750mA, T _J =25°C | — | 4 | 120 | mV |
| Bias current | I _{bias} | T _J =25°C | — | 2.5 | 5 | mA |
| Input bias fluctuation | ΔI _{bias (IN)} | V _I =-14.5 to -30V, T _J =25°C | — | — | 1 | mA |
| Load bias current fluctuation | ΔI _{bias (L)} | I _O =5mA to 1A, T _J =25°C | — | — | 0.5 | mA |
| Output noise voltage | V _{no} | f=10Hz to 100kHz, Ta=25°C | — | 75 | — | μV |
| Ripple rejection ratio | RR | V _I =-15 to -25V, I _O =100mA, f=120Hz | 55 | 70 | — | dB |
| Minimum input/output voltage difference | V _{DIF (min.)} | I _O =1A, T _J =25°C | — | 1.1 | — | V |
| Peak output current | I _{O (Peak)} | T _J =25°C | — | 2.1 | — | A |
| Output voltage temperature coefficient | ΔV _O /Ta | I _O =5mA, T _J =0 to 125°C | — | -0.8 | — | mV/°C |

Note 1) The specified condition T_J=25°C means that the test should be carried out with the test time so short (within 10ms) that the drift in characteristic value due to the rise in chip junction temperature can be ignored.

Note 2) Unless otherwise specified, V_I=-19V, I_O=500mA, C_I=2μF, C_O=1μF, T_J=0 to 125°C

* AN7900T series : 15W, AN7900F series : 10.25W

勝特力材料 886-3-5753170
 勝特力电子(上海) 86-21-34970699
 勝特力电子(深圳) 86-755-83298787
[Http://www.100y.com.tw](http://www.100y.com.tw)

■ Electrical Characteristics (Ta=25°C) (continued)

• AN7915T/AN7915F (-15V Type)

| Parameter | Symbol | Condition | min | typ | max | Unit |
|---|-------------------------------|--|--------|------|--------|----------------------------|
| Output voltage | V_O | $T_j=25^\circ\text{C}$ | -14.4 | -15 | -15.6 | V |
| Output voltage tolerance | V_O | $V_i=-17.5$ to -30V , $I_O=5\text{mA}$ to 1A , $P_D \leq *$ | -14.25 | — | -15.75 | V |
| Line regulation | REG _{IN} | $V_i=-17.5$ to -30V , $T_j=25^\circ\text{C}$ | — | 11 | 300 | mV |
| | | $V_i=-20$ to -26V , $T_j=25^\circ\text{C}$ | — | 3 | 150 | mV |
| Load regulation | REG _L | $I_O=5\text{mA}$ to 1.5A , $T_j=25^\circ\text{C}$ | — | 12 | 300 | mV |
| | | $I_O=250$ to 750mA , $T_j=25^\circ\text{C}$ | — | 4 | 150 | mV |
| Bias current | I_{bias} | $T_j=25^\circ\text{C}$ | — | 2.5 | 5 | mA |
| Input bias fluctuation | $\Delta I_{\text{bias (IN)}}$ | $V_i=-17.5$ to -30V , $T_j=25^\circ\text{C}$ | — | — | 1 | mA |
| Load bias current fluctuation | $\Delta I_{\text{bias (L)}}$ | $I_O=5\text{mA}$ to 1A , $T_j=25^\circ\text{C}$ | — | — | 0.5 | mA |
| Output noise voltage | V_{no} | $f=10\text{Hz}$ to 100kHz , $T_a=25^\circ\text{C}$ | — | 90 | — | μV |
| Ripple rejection ratio | RR | $V_i=-18.5$ to -28.5V , $I_O=100\text{mA}$, $f=120\text{Hz}$ | 54 | 69 | — | dB |
| Minimum input/output voltage difference | $V_{\text{DIF (min.)}}$ | $I_O=1\text{A}$, $T_j=25^\circ\text{C}$ | — | 1.1 | — | V |
| Peak output current | $I_{O(\text{Peak})}$ | $T_j=25^\circ\text{C}$ | — | 2.1 | — | A |
| Output voltage temperature coefficient | $\Delta V_O/T_a$ | $I_O=5\text{mA}$, $T_j=0$ to 125°C | — | -0.9 | — | $\text{mV}/^\circ\text{C}$ |

Note 1) The specified condition $T_j=25^\circ\text{C}$ means that the test should be carried out with the test time so short (within 10ms) that the drift in characteristic value due to the rise in chip junction temperature can be ignored.

Note 2) Unless otherwise specified, $V_i=-23\text{V}$, $I_O=500\text{mA}$, $C_i=2\mu\text{F}$, $C_o=1\mu\text{F}$, $T_j=0$ to 125°C

* AN7900T series : 15W, AN7900F series : 10.25W

• AN7918T/AN7918F (-18V Type)

| Parameter | Symbol | Condition | min | typ | max | Unit |
|---|-------------------------------|--|-------|-----|-------|----------------------------|
| Output voltage | V_O | $T_j=25^\circ\text{C}$ | -17.3 | -18 | -18.7 | V |
| Output voltage tolerance | V_O | $V_i=-21$ to -33V , $I_O=5\text{mA}$ to 1A , $P_D \leq *$ | -17.1 | — | -18.9 | V |
| Line regulation | REG _{IN} | $V_i=-21$ to -33V , $T_j=25^\circ\text{C}$ | — | 15 | 360 | mV |
| | | $V_i=-24$ to -30V , $T_j=25^\circ\text{C}$ | — | 5 | 180 | mV |
| Load regulation | REG _L | $I_O=5\text{mA}$ to 1.5A , $T_j=25^\circ\text{C}$ | — | 12 | 360 | mV |
| | | $I_O=250$ to 750mA , $T_j=25^\circ\text{C}$ | — | 4 | 180 | mV |
| Bias current | I_{bias} | $T_j=25^\circ\text{C}$ | — | 2.5 | 5 | mA |
| Input bias fluctuation | $\Delta I_{\text{bias (IN)}}$ | $V_i=-21$ to -33V , $T_j=25^\circ\text{C}$ | — | — | 1 | mA |
| Load bias current fluctuation | $\Delta I_{\text{bias (L)}}$ | $I_O=5\text{mA}$ to 1A , $T_j=25^\circ\text{C}$ | — | — | 0.5 | mA |
| Output noise voltage | V_{no} | $f=10\text{Hz}$ to 100kHz , $T_a=25^\circ\text{C}$ | — | 110 | — | μV |
| Ripple rejection ratio | RR | $V_i=-22$ to -32V , $I_O=100\text{mA}$, $f=120\text{Hz}$ | 53 | 68 | — | dB |
| Minimum input/output voltage difference | $V_{\text{DIF (min.)}}$ | $I_O=1\text{A}$, $T_j=25^\circ\text{C}$ | — | 1.1 | — | V |
| Peak output current | $I_{O(\text{Peak})}$ | $T_j=25^\circ\text{C}$ | — | 2.1 | — | A |
| Output voltage temperature coefficient | $\Delta V_O/T_a$ | $I_O=5\text{mA}$, $T_j=0$ to 125°C | — | -1 | — | $\text{mV}/^\circ\text{C}$ |

Note 1) The specified condition $T_j=25^\circ\text{C}$ means that the test should be carried out with the test time so short (within 10ms) that the drift in characteristic value due to the rise in chip junction temperature can be ignored.

Note 2) Unless otherwise specified, $V_i=-27\text{V}$, $I_O=500\text{mA}$, $C_i=2\mu\text{F}$, $C_o=1\mu\text{F}$, $T_j=0$ to 125°C

* AN7900T series : 15W, AN7900F series : 10.25W

勝特力材料 886-3-5753170
 勝特力电子(上海) 86-21-34970699
 勝特力电子(深圳) 86-755-83298787
[Http://www.100y.com.tw](http://www.100y.com.tw)

■ Electrical Characteristics (Ta=25°C) (continued)

• AN7920T/AN7920F (–20V Type)

| Parameter | Symbol | Condition | min | typ | max | Unit |
|---|-------------------------|--|-------|-----|-------|-------|
| Output voltage | V _O | T _J =25°C | -19.2 | -20 | -20.8 | V |
| Output voltage tolerance | V _O | V _I =-23 to -35V, I _O =5mA to 1A, P _D ≤* | -19 | — | -21 | V |
| Line regulation | REG _{IN} | V _I =-23 to -35V, T _J =25°C | — | 16 | 400 | mV |
| | | V _I =-26 to -32V, T _J =25°C | — | 5.5 | 200 | mV |
| Load regulation | REG _L | I _O =5mA to 1.5A, T _J =25°C | — | 12 | 400 | mV |
| | | I _O =250 to 750mA, T _J =25°C | — | 4 | 200 | mV |
| Bias current | I _{bias} | T _J =25°C | — | 3 | 5 | mA |
| Input bias fluctuation | ΔI _{bias (IN)} | V _I =-23 to -35V, T _J =25°C | — | — | 1 | mA |
| Load bias current fluctuation | ΔI _{bias (L)} | I _O =5mA to 1A, T _J =25°C | — | — | 0.5 | mA |
| Output noise voltage | V _{no} | f=10Hz to 100kHz, Ta=25°C | — | 135 | — | μV |
| Ripple rejection ratio | RR | V _I =-24 to -34V, I _O =100mA, f=120Hz | 52 | 67 | — | dB |
| Minimum input/output voltage difference | V _{DIF (min.)} | I _O =1A, T _J =25°C | — | 1.1 | — | V |
| Peak output current | I _{O (Peak)} | T _J =25°C | — | 2.1 | — | A |
| Output voltage temperature coefficient | ΔV _O /Ta | I _O =5mA, T _J =0 to 125°C | — | -1 | — | mV/°C |

Note 1) The specified condition T_J=25°C means that the test should be carried out with the test time so short (within 10ms) that the drift in characteristic value due to the rise in chip junction temperature can be ignored.

Note 2) Unless otherwise specified, V_I=-29V, I_O=500mA, C_I=2μF, C_O=1μF, T_J=0 to 125°C

* AN7900T series : 15W, AN7900F series : 10.25W

• AN7924T/AN7924F (–24V Type)

| Parameter | Symbol | Condition | min | typ | max | Unit |
|---|-------------------------|--|-------|-----|-------|-------|
| Output voltage | V _O | T _J =25°C | -23 | -24 | -25 | V |
| Output voltage tolerance | V _O | V _I =-27 to -38V, I _O =5mA to 1A, P _D ≤* | -22.8 | — | -25.2 | V |
| Line regulation | REG _{IN} | V _I =-27 to -38V, T _J =25°C | — | 18 | 480 | mV |
| | | V _I =-30 to -36V, T _J =25°C | — | 6 | 240 | mV |
| Load regulation | REG _L | I _O =5mA to 1.5A, T _J =25°C | — | 12 | 480 | mV |
| | | I _O =250 to 750mA, T _J =25°C | — | 4 | 240 | mV |
| Bias current | I _{bias} | T _J =25°C | — | 3 | 5 | mA |
| Input bias fluctuation | ΔI _{bias (IN)} | V _I =-27 to -38V, T _J =25°C | — | — | 1 | mA |
| Load bias current fluctuation | ΔI _{bias (L)} | I _O =5mA to 1A, T _J =25°C | — | — | 0.5 | mA |
| Output noise voltage | V _{no} | f=10Hz to 100kHz, Ta=25°C | — | 170 | — | μV |
| Ripple rejection ratio | RR | V _I =-28 to -38V, I _O =100mA, f=120Hz | 50 | 65 | — | dB |
| Minimum input/output voltage difference | V _{DIF (min.)} | I _O =1A, T _J =25°C | — | 1.1 | — | V |
| Peak output current | I _{O (Peak)} | T _J =25°C | — | 2.1 | — | A |
| Output voltage temperature coefficient | ΔV _O /Ta | I _O =5mA, T _J =0 to 125°C | — | -1 | — | mV/°C |

Note 1) The specified condition T_J=25°C means that the test should be carried out with the test time so short (within 10ms) that the drift in characteristic value due to the rise in chip junction temperature can be ignored.

Note 2) Unless otherwise specified, V_I=-33V, I_O=500mA, C_I=2μF, C_O=1μF, T_J=0 to 125°C

* AN7900T series : 15W, AN7900F series : 10.25W

勝特力材料 886-3-5753170
 勝特力电子(上海) 86-21-34970699
 勝特力电子(深圳) 86-755-83298787
[Http://www.100y.com.tw](http://www.100y.com.tw)

■ Characteristic Curve

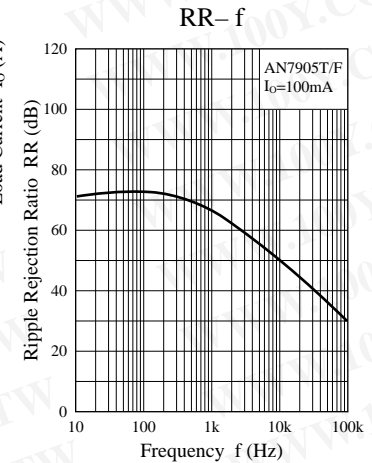
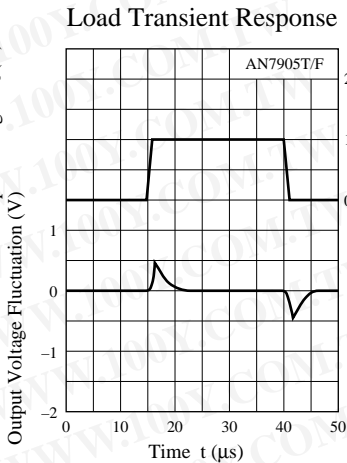
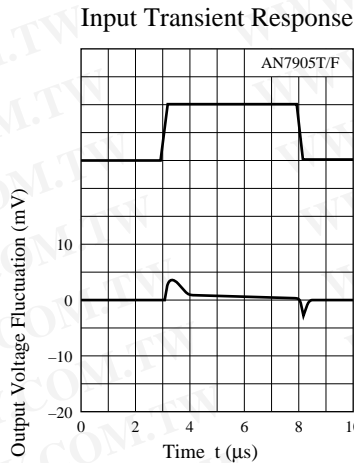
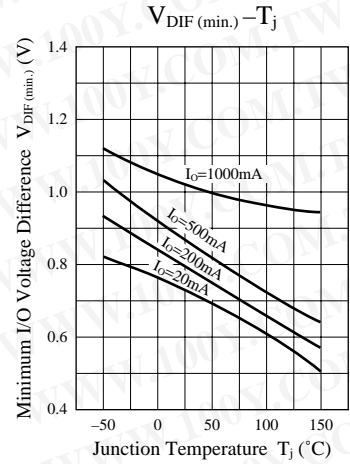
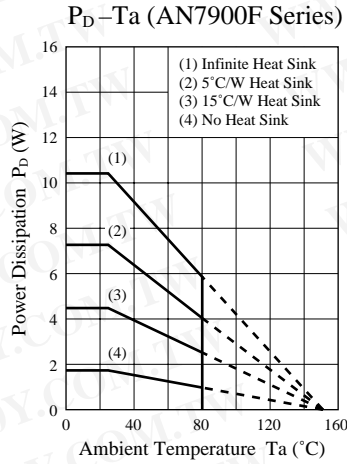
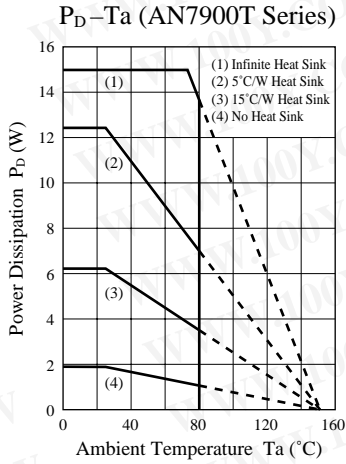

■ Basic Regulator Circuit

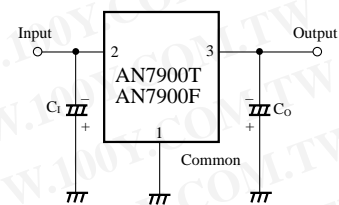

C_1 : Required when the input line is long
 C_0 : Improves the transient response.

■ Application Circuit

1) Current Bootstrap Circuit

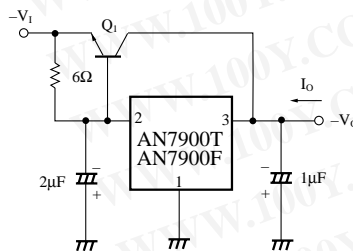

2) Adjustable Output Regulator

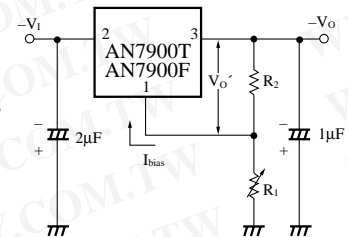

$$|V_o| = V_o' + \left(I_{bias} + \frac{V_o'}{R_2} \right) R_1$$

勝特力材料 886-3-5753170
勝特力电子(上海) 86-21-34970699
勝特力电子(深圳) 86-755-83298787

[Http://www.100y.com.tw](http://www.100y.com.tw)