

MA4810

OUTLINE DIMENSIONS

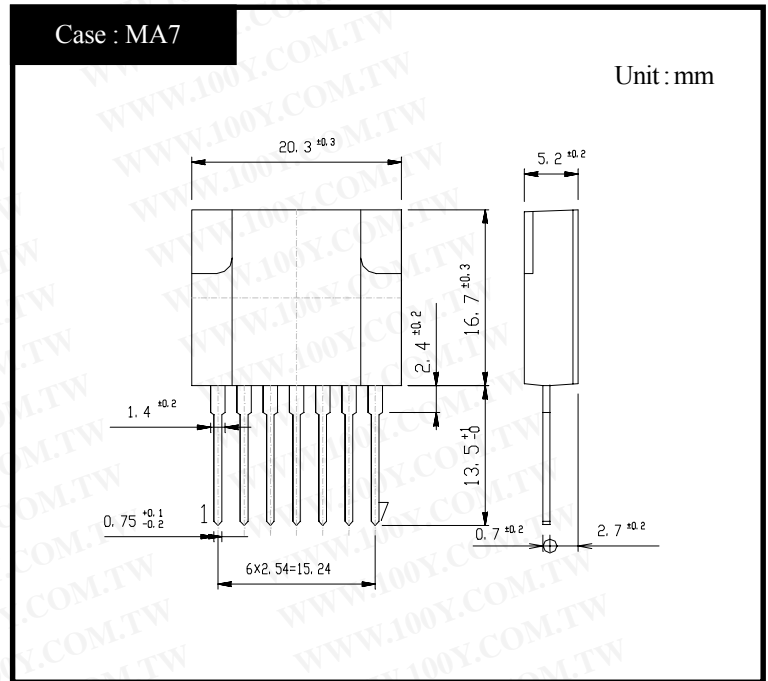

RATINGS

● Absolute Maximum Ratings

Item	Symbol	Conditions	Ratings	Unit
Storage Temperature	T _{stg}		-30~125	°C
Operating Temperature	T _{op}		-20~125	°C
Junction Temperature	T _j		150	°C
Peak Input Voltage	V _{in}	②+,③-,⑤-	800	V
Input Current	I _{in}	DC ②+,③-	3	A
		Pulse ②+,③- Duty 1/2	6	A
Maximum Power Dissipation	P _D	T _a =25°C	3	W
		Heatsink T _c =100°C	17	W
Dielectric Strength	V _{dis}	Terminals To Case AC 1 min	2	kV
Insulation Resistance		Terminals To Case 500VDC	100	MΩ
Max Voltage ④ to ⑥	V(④·⑥)	④+,⑥-	6	V
Max Current ⑥ to ④	I(⑥·④)	⑥+,④- (Peak) Duty Max 1/2	200	mA
Reverse Current	I _Z	⑤+,④-	MAX 20	mA

● Electrical Characteristics (T_c=25°C)

Item	Symbol	Conditions	Ratings	Unit
Q1	Zero Gate Voltage Drain Current	I _{DSS} V _{DS} =800V, V _{GS} =0V, ②+,③-	MAX 250	μA
	Static Drain-Source On-State Resistance	R _{DS(on)} I _D =1.5A, ②+,③- V _{GS} =10V, ⑤+,③-	TYP (4.1)	Ω
			MAX 5.0	Ω
	Thermal Resistance	θ _{jc} Junction to Case	MAX 2.9	°C/W
D1	Reverse Current	I _R V _i =800V, ①+,②-	MAX 10	μA
	Forward Voltage	V _F I _F =0.6A, ②+,①-	MAX 1.7	V
Q2	Fold Back Detection Voltage	③+,④-	TYP 0.7	V

●Standard Operating Condition•Design Standard For Application Circuit

Item	Conditions	Ratings	Unit
Input Rated Voltage		AC90~276	V
Output Nominal Voltage		12	V
Output Nominal Current		2.5	A

●Standard Operating Condition•Standard Operating Characteristics (Ta=25°C)

Item	Conditions	Ratings	Unit	
Minimum Input Full Load Output Voltage	Vin=90V, Io=2.5A	12.0±0.6	V	Fig 1, ① Refer
Maximum Input Light Load Output Voltage	Vin=276V, Io=0.25A	12.0±0.6	V	Fig 1, ② Refer
Over Current Protection	Foldback Current Vin=276V, Vo=10V	MAX 3.8	A	Fig 1, ③ Refer
	Short Circuit Vin=276V, Ro=0.5Ω		-	Fig 1, ④ Refer

Figure in ○=Terminal Sign

勝特力材料 886-3-5753170
勝特力电子(上海) 86-21-54151736
勝特力电子(深圳) 86-755-83298787
[Http://www.100y.com.tw](http://www.100y.com.tw)

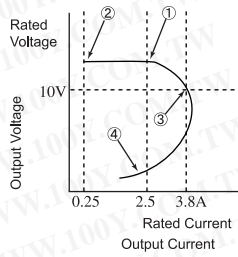
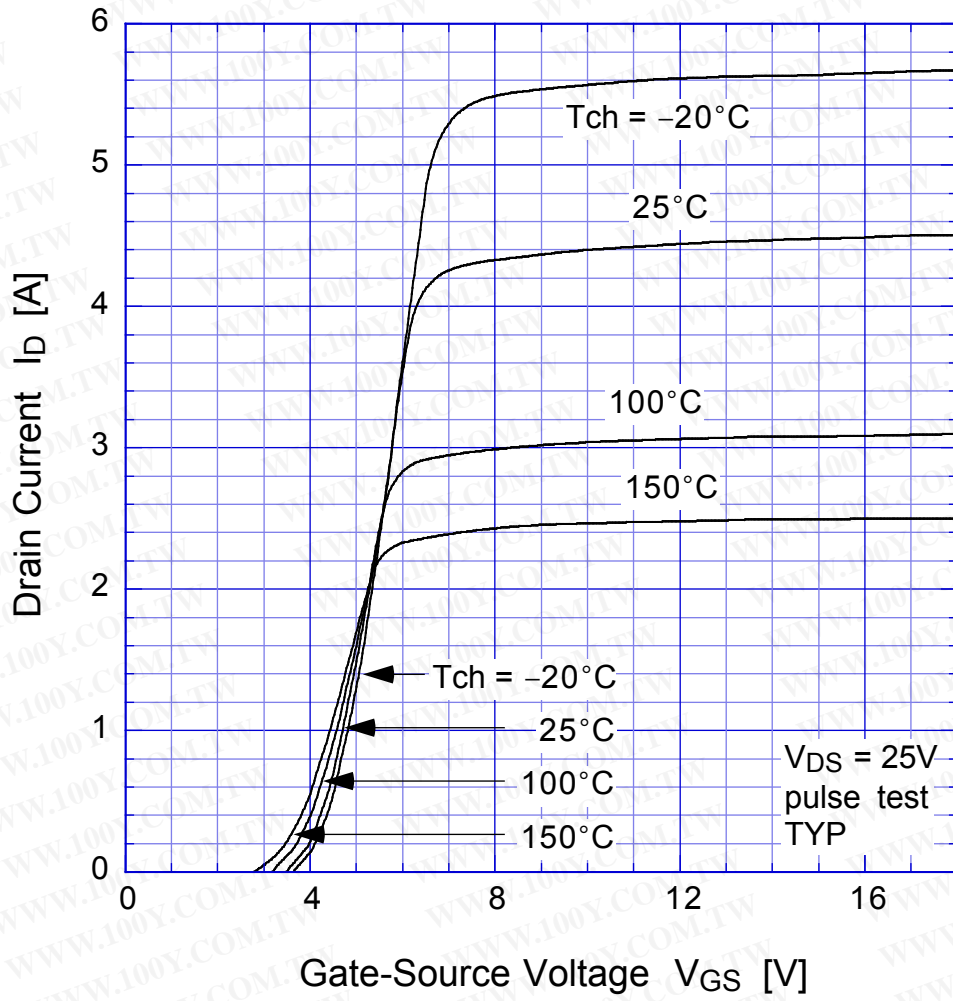

Fig1. Output Voltage/Current

勝特力材料 886-3-5753170
勝特力电子(上海) 86-21-54151736
勝特力电子(深圳) 86-755-83298787
[Http://www.100y.com.tw](http://www.100y.com.tw)

MA4810 Transfer Characteristics



勝特力材料 886-3-5753170
勝特力电子(上海) 86-21-54151736
勝特力电子(深圳) 86-755-83298787
[Http://www.100y.com.tw](http://www.100y.com.tw)

MA4810 Static Drain-Source On-state Resistance

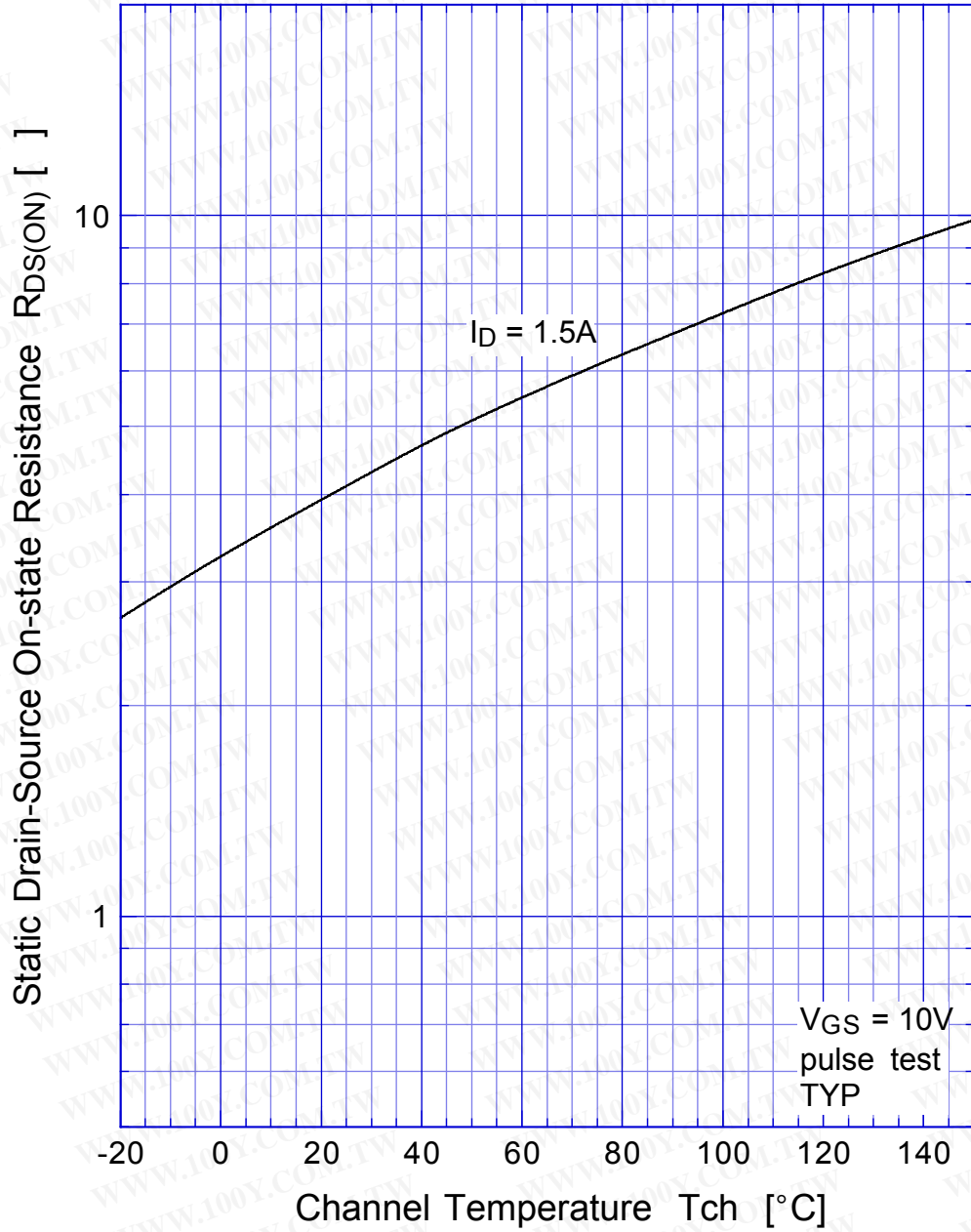

勝特力材料 886-3-5753170
勝特力电子(上海) 86-21-54151736
勝特力电子(深圳) 86-755-83298787
[Http://www.100y.com.tw](http://www.100y.com.tw)

MA4810 Gate Threshold Voltage

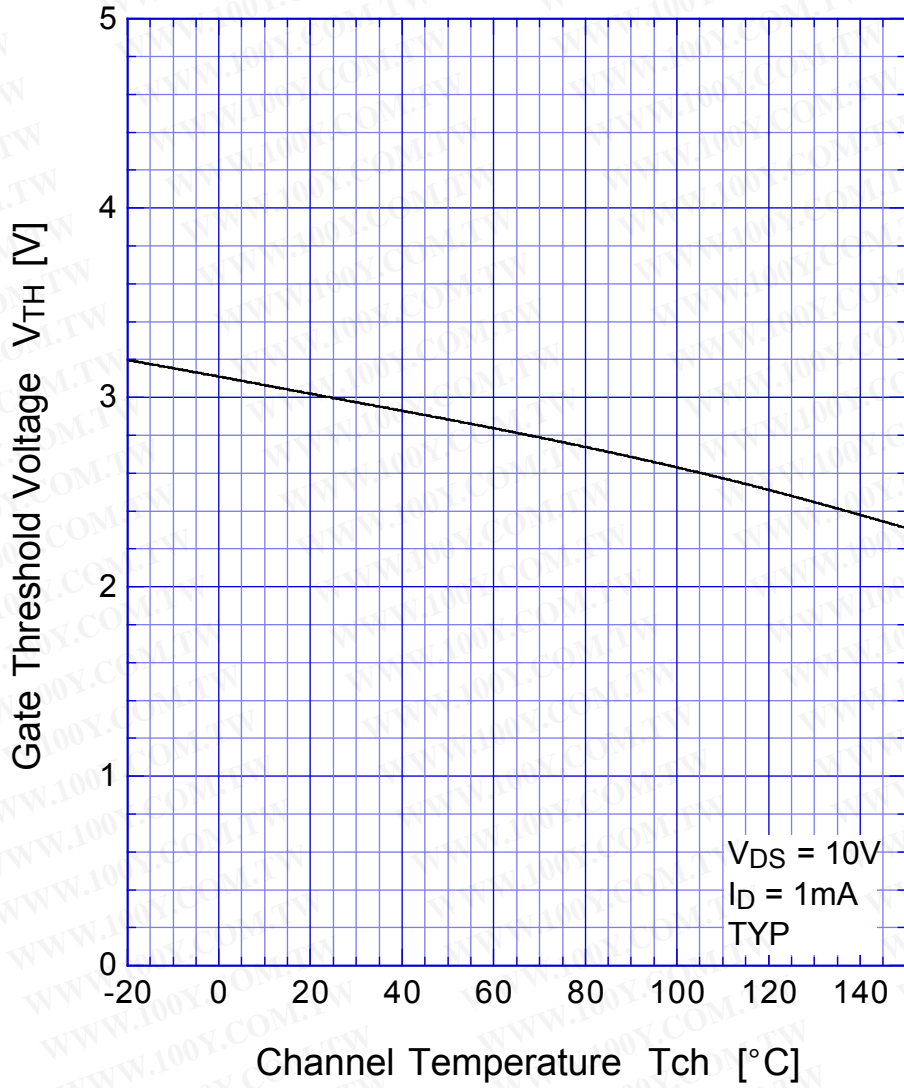

MA4810 Capacitance

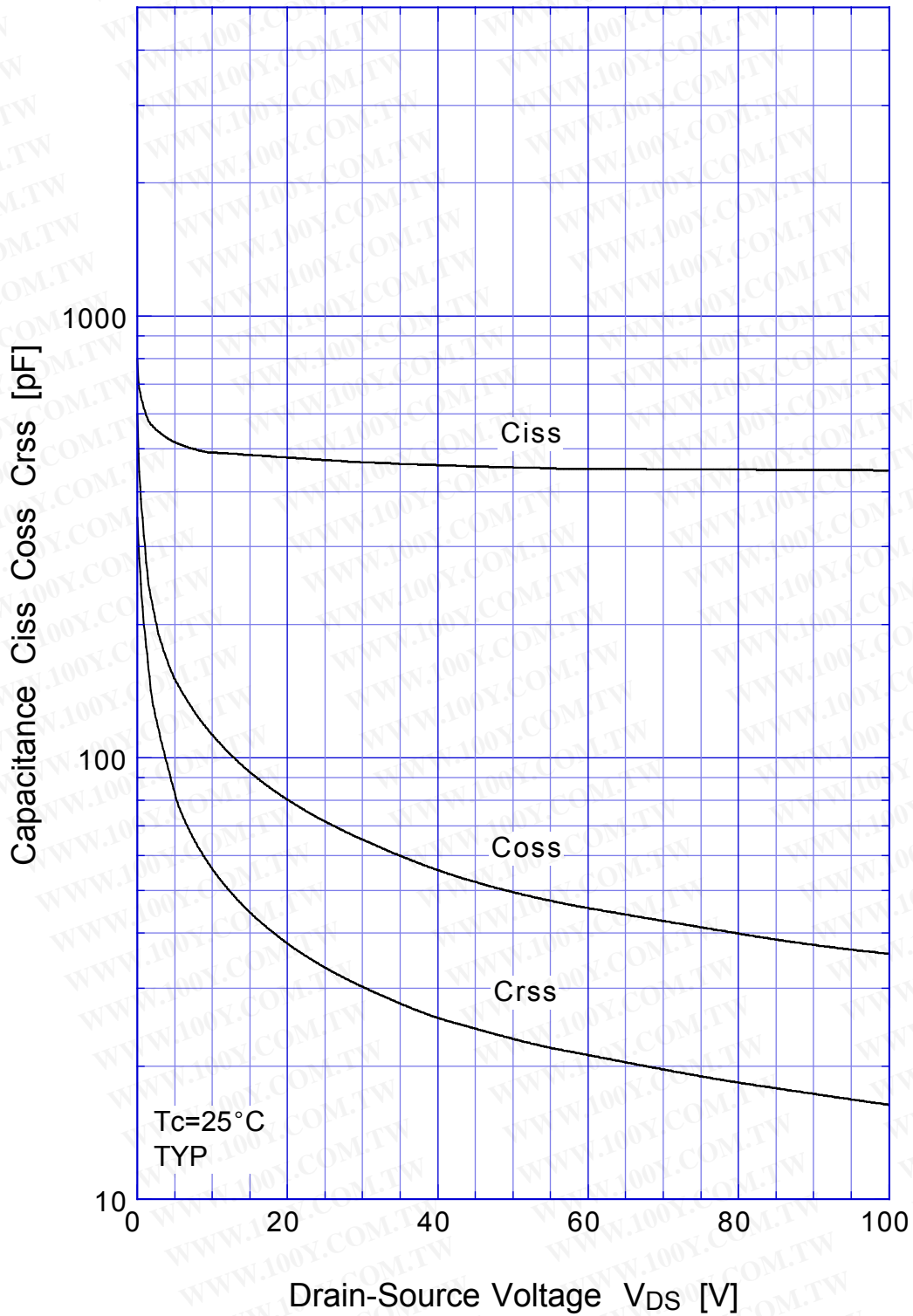

勝特力材料 886-3-5753170
勝特力电子(上海) 86-21-54151736
勝特力电子(深圳) 86-755-83298787
[Http://www.100y.com.tw](http://www.100y.com.tw)

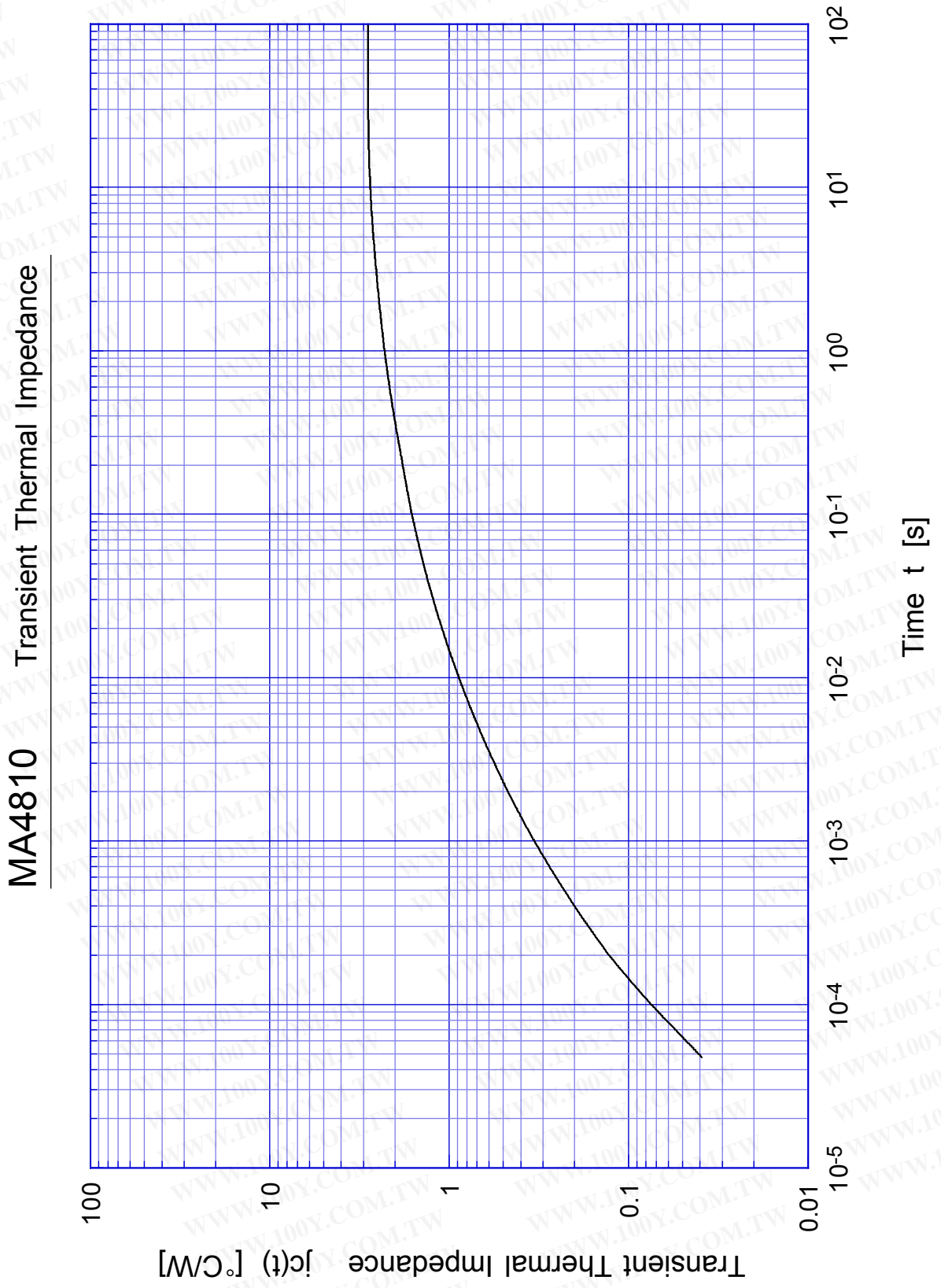

勝特力材料 886-3-5753170
勝特力电子(上海) 86-21-54151736
勝特力电子(深圳) 86-755-83298787
[Http://www.100y.com.tw](http://www.100y.com.tw)

MA4810 Safe Operating Area

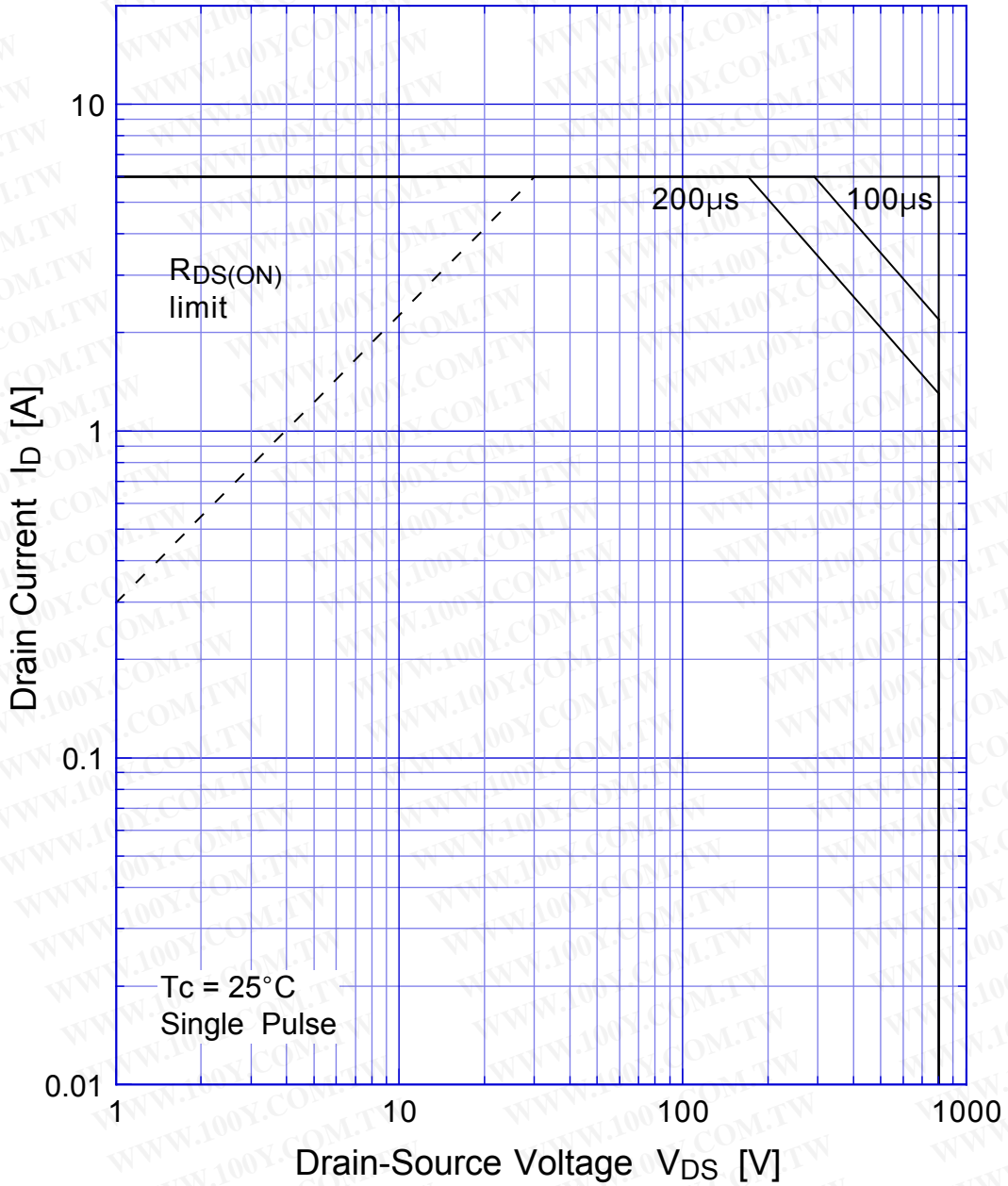

勝特力材料 886-3-5753170
勝特力电子(上海) 86-21-54151736
勝特力电子(深圳) 86-755-83298787
[Http://www.100y.com.tw](http://www.100y.com.tw)

MA4810

Power Derating

