

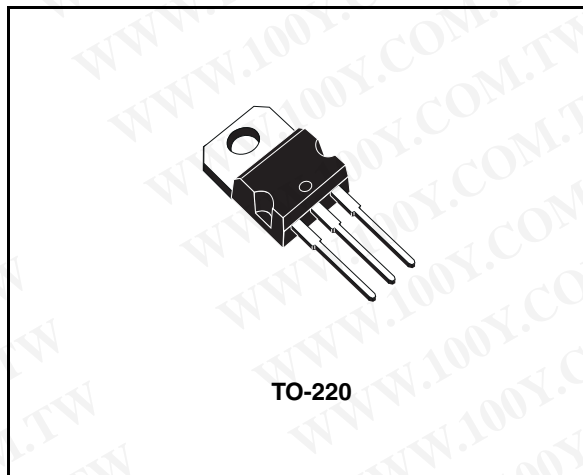

5 A low drop positive voltage regulator adjustable and fixed

Features

- Typical dropout 1.3 V (at 5 A)
- Three terminal adjustable or fixed output voltage 2.5 V, 5 V, 12 V.
- Guaranteed output current up to 5 A
- Output tolerance $\pm 1\%$ at 25 °C and $\pm 2\%$ in full temperature range
- Internal power and thermal limit
- Wide operating temperature range -40 °C to 125 °C
- Package available: TO-220
- Pinout compatibility with standard adjustable VREG



The device is supplied in TO-220. On chip trimming allows the regulator to reach a very tight output voltage tolerance, within $\pm 1\%$ at 25 °C.

Description

The LD1084xx is a low drop voltage regulator able to provide up to 5 A of output current. Dropout is guaranteed at a maximum of 1.5 V at the maximum output current, decreasing at lower loads. The LD1084xx is pin to pin compatible with the older 3-terminal adjustable regulators, but has better performances in term of drop and output tolerance.

A 2.85 V output version is suitable for SCSI-2 active termination. Unlike PNP regulators, where a part of the output current is wasted as quiescent current, the LD1084xx quiescent current flows into the load, so increase efficiency. Only a 10 μ F minimum capacitor is need for stability.

勝特力材料 886-3-5753170
勝特力电子(上海) 86-21-54151736
勝特力电子(深圳) 86-755-83298787
[Http://www.100y.com.tw](http://www.100y.com.tw)

Table 1. Device summary

Part numbers	Order codes	Output voltage
LD1084XX12	LD1084V12	12 V
LD1084XX25	LD1084V25	2.5 V
LD1084XX50	LD1084V50	5.0 V
LD1084XX	LD1084V	Adjustable

Contents

1	Diagram	3
2	Pin configuration	4
3	Maximum ratings	5
4	Schematic application	6
5	Electrical characteristics	7
6	Typical application	11
7	Package mechanical data	16
8	Revision history	18

1 Diagram

Figure 1. Schematic diagram

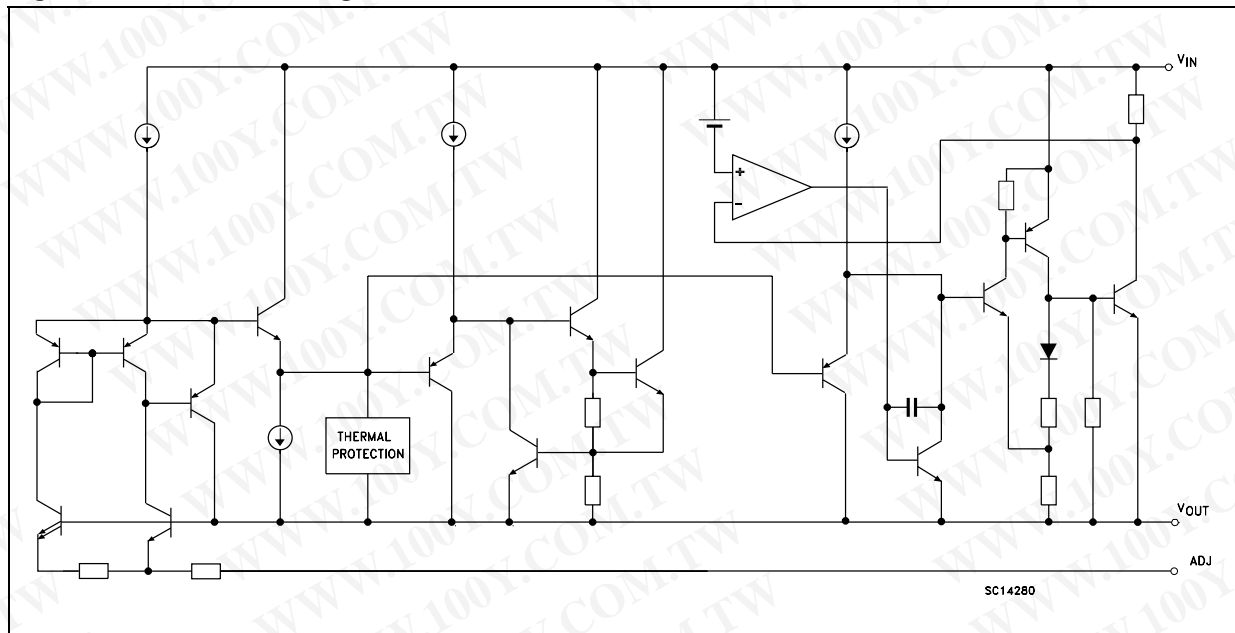

勝特力材料 886-3-5753170
勝特力电子(上海) 86-21-54151736
勝特力电子(深圳) 86-755-83298787
[Http://www.100y.com.tw](http://www.100y.com.tw)

2 Pin configuration

Figure 2. Pin connections (top view)

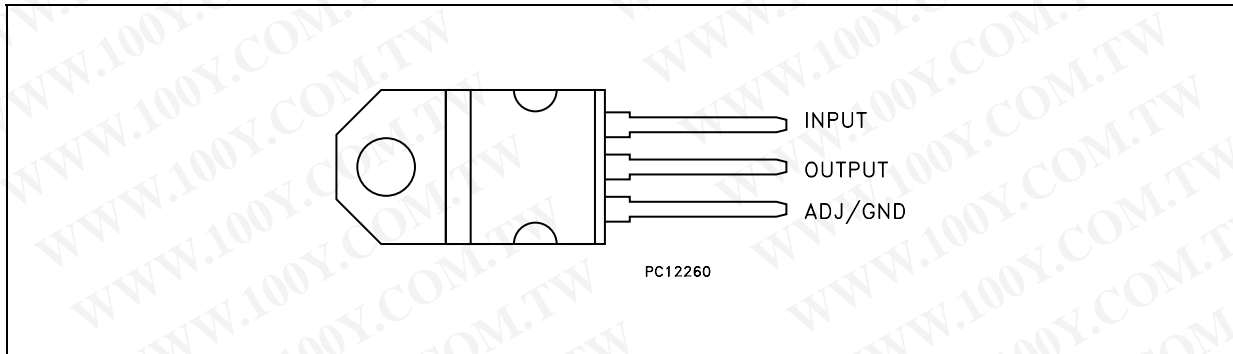

勝特力材料 886-3-5753170
勝特力电子(上海) 86-21-54151736
勝特力电子(深圳) 86-755-83298787
[Http://www.100y.com.tw](http://www.100y.com.tw)

3 Maximum ratings

Table 2. Absolute maximum ratings

Symbol	Parameter	Value	Unit
V_I	DC input voltage	30	V
I_O	Output current	Internally limited	mA
P_D	Power dissipation	Internally limited	mW
T_{STG}	Storage temperature range	-55 to +150	°C
T_{OP}	Operating junction temperature range	-40 to +125	°C

Note: Absolute maximum ratings are those values beyond which damage to the device may occur. Functional operation under these condition is not implied

Table 3. Thermal data

Symbol	Parameter	TO-220	Unit
R_{thJC}	Thermal resistance junction-case	3	°C/W
R_{thJA}	Thermal resistance junction-ambient	50	°C/W

4 Schematic application

Figure 3. Application circuit

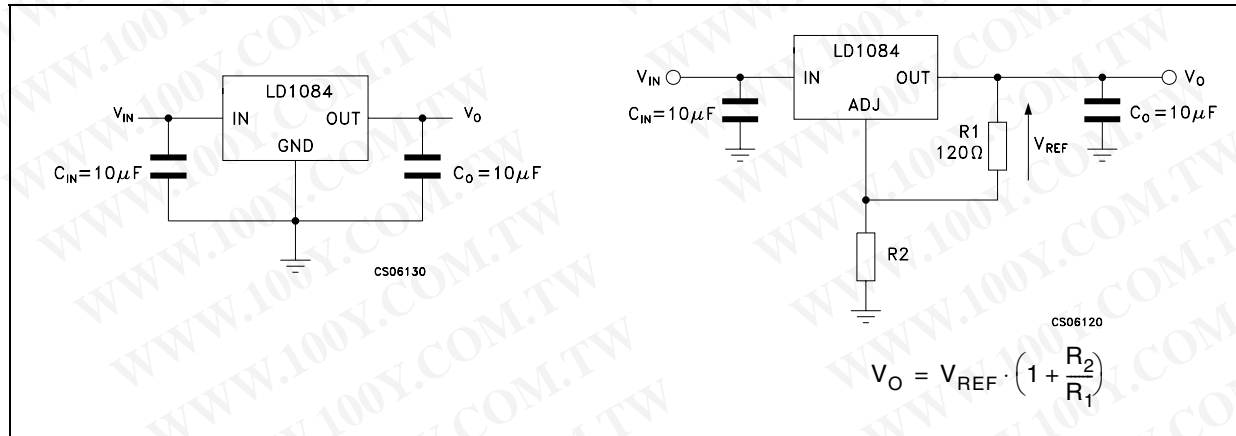

勝特力材料 886-3-5753170
 勝特力电子(上海) 86-21-54151736
 勝特力电子(深圳) 86-755-83298787
[Http://www.100y.com.tw](http://www.100y.com.tw)

5 Electrical characteristics

Table 4. Electrical characteristics of LD1084#25
($V_I = 5.5\text{ V}$, $C_I = C_O = 10\ \mu\text{F}$, $T_A = -40\text{ to }125\text{ }^\circ\text{C}$, unless otherwise specified).

Symbol	Parameter	Test condition	Min.	Typ.	Max.	Unit
V_O	Output voltage ⁽¹⁾	$I_O = 0\text{ mA}$, $T_J = 25^\circ\text{C}$	2.475	2.5	2.525	V
		$I_O = 0\text{ to }5\text{ A}$, $V_I = 4.1\text{ to }30\text{ V}$	2.45	2.5	2.55	V
ΔV_O	Line regulation	$I_O = 0\text{ mA}$, $V_I = 4.1\text{ to }18\text{ V}$, $T_J = 25^\circ\text{C}$		0.5	6	mV
		$I_O = 0\text{ mA}$, $V_I = 4.1\text{ to }18\text{ V}$		0.1	6	mV
ΔV_O	Load regulation	$I_O = 0\text{ to }5\text{ A}$, $T_J = 25^\circ\text{C}$		3	15	mV
		$I_O = 0\text{ to }5\text{ A}$		7	20	mV
V_d	Dropout voltage	$I_O = 5\text{ A}$		1.3	1.5	V
I_q	Quiescent current	$V_I \leq 30\text{ V}$		5	10	mA
I_{sc}	Short circuit current	$V_I - V_O = 5\text{ V}$	5.5	6.5		A
		$V_I - V_O = 25\text{ V}$	0.5	0.7		A
	Thermal regulation	$T_A = 25^\circ\text{C}$, 30ms pulse		0.003	0.015	%/W
SVR	Supply voltage rejection	$f = 120\text{ Hz}$, $C_O = 25\ \mu\text{F}$, $I_O = 5\text{ A}$ $V_I = 7.5 \pm 3\text{ V}$	60	72		dB
eN	RMS output noise voltage (% of V_O)	$T_A = 25^\circ\text{C}$, $f = 10\text{ Hz to }10\text{ kHz}$		0.003		%
S	Temperature stability			0.5		%
S	Long term stability	$T_A = 125^\circ\text{C}$, 1000Hrs		0.5		%

1. See short-circuit current curve for available output current at fixed dropout.

Table 5. Electrical characteristics of LD1084#50
 ($V_I = 8\text{ V}$, $C_I = C_O = 10\ \mu\text{F}$, $T_A = -40\text{ to }125\text{ }^\circ\text{C}$, unless otherwise specified).

Symbol	Parameter	Test condition	Min.	Typ.	Max.	Unit
V_O	Output voltage ⁽¹⁾	$I_O = 0\text{ mA}$, $T_J = 25^\circ\text{C}$	4.95	5	5.05	V
		$I_O = 0\text{ to }5\text{ A}$, $V_I = 6.6\text{ to }30\text{ V}$	4.9	5	5.1	V
ΔV_O	Line regulation	$I_O = 0\text{ mA}$, $V_I = 6.6\text{ to }20\text{ V}$, $T_J = 25^\circ\text{C}$		0.5	10	mV
		$I_O = 0\text{ mA}$, $V_I = 6.6\text{ to }20\text{ V}$		1	10	mV
ΔV_O	Load regulation	$I_O = 0\text{ to }5\text{ A}$, $T_J = 25^\circ\text{C}$		5	20	mV
		$I_O = 0\text{ to }5\text{ A}$		10	35	mV
V_d	Dropout voltage	$I_O = 5\text{ A}$		1.3	1.5	V
I_q	Quiescent current	$V_I \leq 30\text{ V}$		5	10	mA
I_{sc}	Short circuit current	$V_I - V_O = 5\text{ V}$	5.5	6.5		A
		$V_I - V_O = 25\text{ V}$	0.5	0.7		A
	Thermal regulation	$T_A = 25^\circ\text{C}$, 30ms pulse		0.003	0.015	%/W
SVR	Supply voltage rejection	$f = 120\text{ Hz}$, $C_O = 25\ \mu\text{F}$, $I_O = 5\text{ A}$ $V_I = 10 \pm 3\text{ V}$	60	72		dB
eN	RMS output noise voltage (% of V_O)	$T_A = 25^\circ\text{C}$, $f = 10\text{ Hz to }10\text{ kHz}$		0.003		%
S	Temperature stability			0.5		%
S	Long term stability	$T_A = 125^\circ\text{C}$, 1000Hrs		0.5		%

1. See short-circuit current curve for available output current at fixed dropout.

勝特力材料 886-3-5753170
 勝特力电子(上海) 86-21-54151736
 勝特力电子(深圳) 86-755-83298787
[Http://www.100y.com.tw](http://www.100y.com.tw)

Table 6. Electrical characteristics of LD1084#12
 ($V_I = 15\text{ V}$, $C_I = C_O = 10\ \mu\text{F}$, $T_A = -40\text{ to }125\text{ }^\circ\text{C}$, unless otherwise specified).

Symbol	Parameter	Test condition	Min.	Typ.	Max.	Unit
V_O	Output voltage ⁽¹⁾	$I_O = 0\text{ mA}$, $T_J = 25^\circ\text{C}$	11.88	12	12.12	V
		$I_O = 0\text{ to }5\text{ A}$, $V_I = 13.6\text{ to }30\text{ V}$	11.76	12	12.24	V
ΔV_O	Line regulation	$I_O = 0\text{ mA}$, $V_I = 13.6\text{ to }25\text{ V}$, $T_J = 25^\circ\text{C}$		2	25	mV
		$I_O = 0\text{ mA}$, $V_I = 13.6\text{ to }25\text{ V}$		4	25	mV
ΔV_O	Load regulation	$I_O = 0\text{ to }5\text{ A}$, $T_J = 25^\circ\text{C}$		12	36	mV
		$I_O = 0\text{ to }5\text{ A}$		24	72	mV
V_d	Dropout voltage	$I_O = 5\text{ A}$		1.3	1.5	V
I_q	Quiescent current	$V_I \leq 30\text{ V}$		5	10	mA
I_{sc}	Short circuit current	$V_I - V_O = 5\text{ V}$	5.5	6.5		A
		$V_I - V_O = 25\text{ V}$	0.5	0.7		A
	Thermal regulation	$T_A = 25^\circ\text{C}$, 30ms pulse		0.003	0.015	%/W
SVR	Supply voltage rejection	$f = 120\text{ Hz}$, $C_O = 25\ \mu\text{F}$, $I_O = 5\text{ A}$ $V_I = 17 \pm 3\text{ V}$	54	66		dB
eN	RMS output noise voltage (% of V_O)	$T_A = 25^\circ\text{C}$, $f = 10\text{ Hz to }10\text{ kHz}$		0.003		%
S	Temperature stability			0.5		%
S	Long term stability	$T_A = 125^\circ\text{C}$, 1000Hrs		0.5		%

1. See short-circuit current curve for available output current at fixed dropout.

勝特力材料 886-3-5753170
 勝特力电子(上海) 86-21-54151736
 勝特力电子(深圳) 86-755-83298787
[Http://www.100y.com.tw](http://www.100y.com.tw)

Table 7. Electrical characteristics of LD1084
 ($V_I = 4.25\text{ V}$, $C_I = C_O = 10\ \mu\text{F}$, $T_A = -40\text{ to }125\text{ }^\circ\text{C}$, unless otherwise specified).

Symbol	Parameter	Test condition	Min.	Typ.	Max.	Unit
V_O	Output voltage ⁽¹⁾	$I_O = 10\text{mA}$, $T_J = 25^\circ\text{C}$	1.237	1.25	1.263	V
		$I_O = 10\text{mA to }3\text{A}$, $V_I = 2.85\text{ to }30\text{V}$	1.225	1.25	1.275	V
ΔV_O	Line regulation	$I_O = 10\text{mA}$, $V_I = 2.85\text{ to }16.5\text{V}$, $T_J = 25^\circ\text{C}$		0.015	0.2	%
		$I_O = 10\text{mA}$, $V_I = 2.85\text{ to }16.5\text{V}$		0.035	0.2	%
ΔV_O	Load regulation	$I_O = 10\text{mA to }5\text{A}$, $T_J = 25^\circ\text{C}$		0.1	0.3	%
		$I_O = 0\text{ to }5\text{A}$		0.2	0.4	%
V_d	Dropout voltage	$I_O = 5\text{A}$		1.3	1.5	V
$I_{O(\text{min})}$	Minimum load current	$V_I = 30\text{V}$		3	10	mA
I_{sc}	Short circuit current	$V_I - V_O = 5\text{V}$	5.5	6.5		A
		$V_I - V_O = 25\text{V}$	0.5	0.7		A
	Thermal regulation	$T_A = 25^\circ\text{C}$, 30ms pulse		0.003	0.015	%/W
SVR	Supply voltage rejection	$f = 120\text{ Hz}$, $C_O = 25\ \mu\text{F}$, $C_{\text{ADJ}} = 25\ \mu\text{F}$, $I_O = 5\text{A}$, $V_I = 6.25 \pm 3\text{V}$	60	72		dB
I_{ADJ}	Adjust pin current	$V_I = 4.25\text{V}$, $I_O = 10\text{ mA}$		55	120	μA
ΔI_{ADJ}	Adjust pin current change ⁽¹⁾	$I_O = 10\text{mA to }5\text{A}$, $V_I = 2.85\text{ to }16.5\text{V}$		0.2	5	μA
eN	RMS output noise voltage (% of V_O)	$T_A = 25^\circ\text{C}$, $f = 10\text{Hz to }10\text{kHz}$		0.003		%
S	Temperature stability			0.5		%
S	Long term stability	$T_A = 125^\circ\text{C}$, 1000Hrs		0.5		%

1. See short-circuit current curve for available output current at fixed dropout.

6 Typical application

Unless otherwise specified $T_J = 25^\circ\text{C}$, $C_1 = 10\mu\text{F}$ (tant.), $C_O = 22\mu\text{F}$ (tant.)

Figure 4. Short circuit current vs dropout voltage

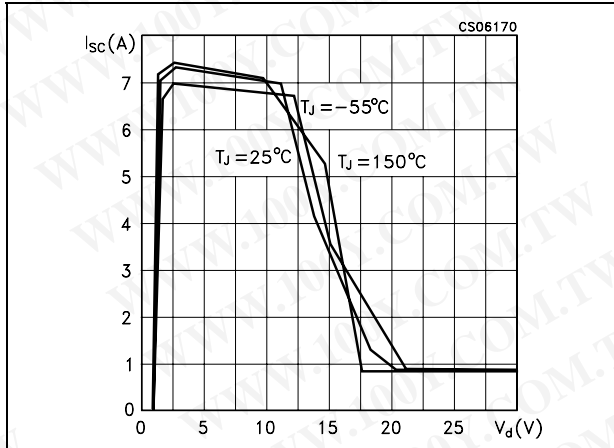

Figure 5. Line regulation vs temperature

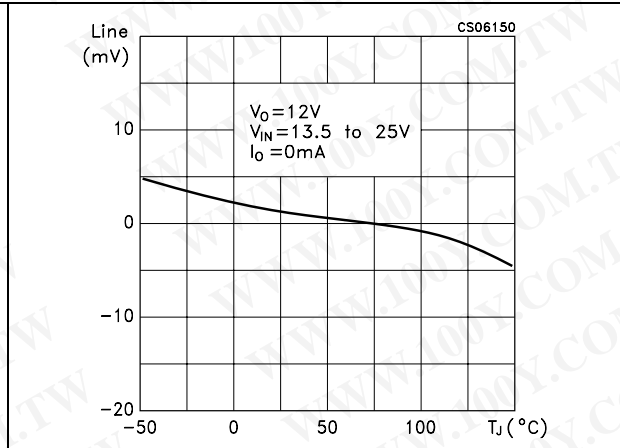

Figure 6. Quiescent current vs temperature

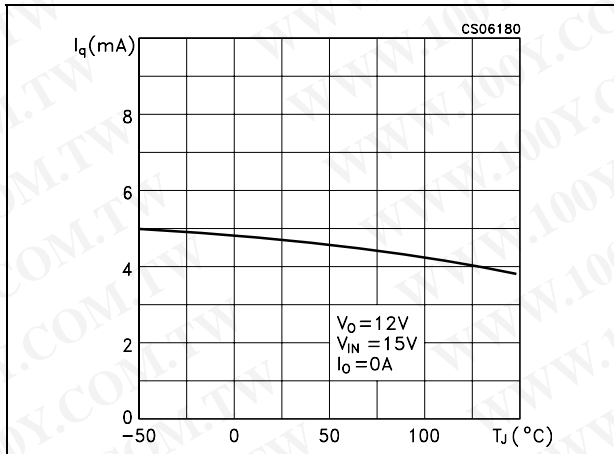

Figure 7. Output voltage vs temperature

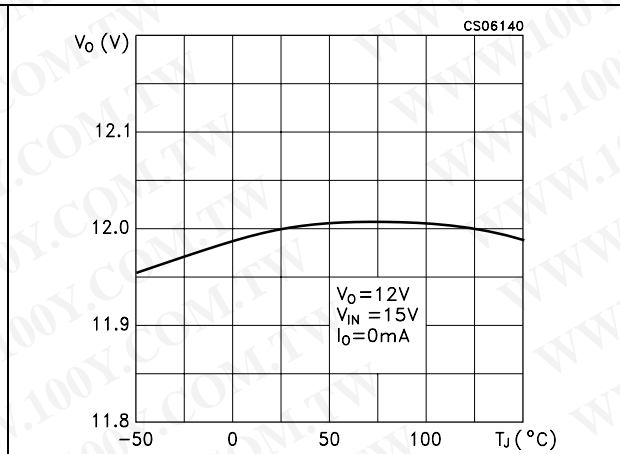

Figure 8. Load regulation vs temperature

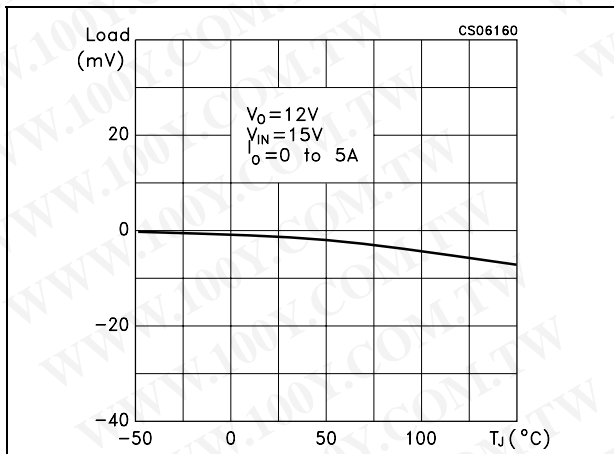

Figure 9. Quiescent current vs output voltage

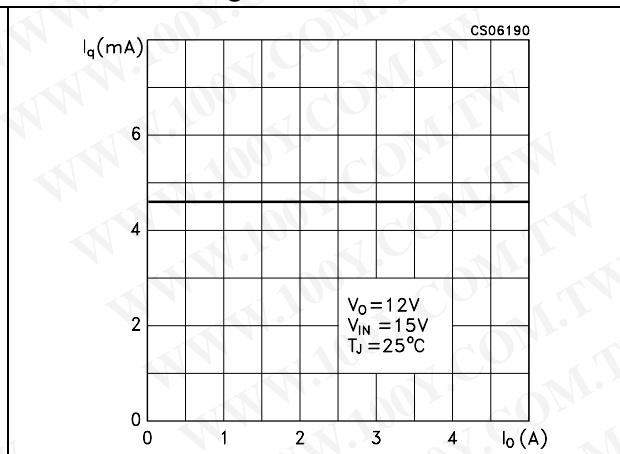

Figure 10. Quiescent current vs input voltage

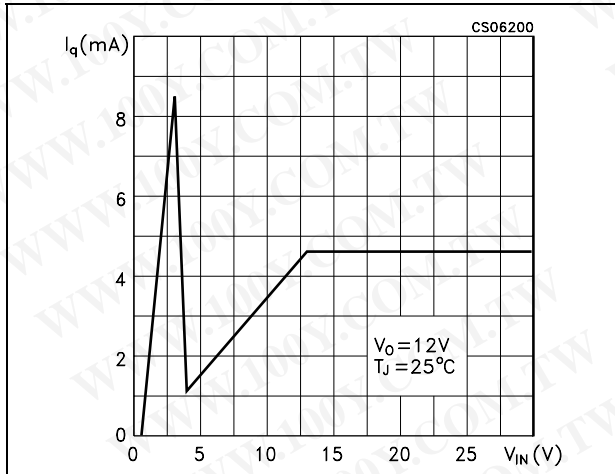

Figure 11. Dropout voltage vs output current

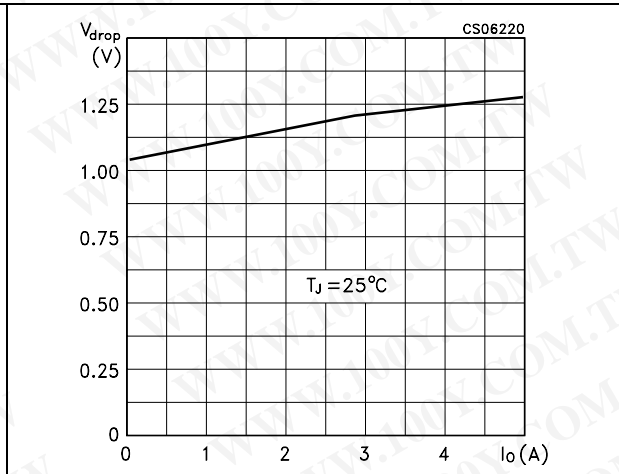

Figure 12. Supply voltage rejection vs output current

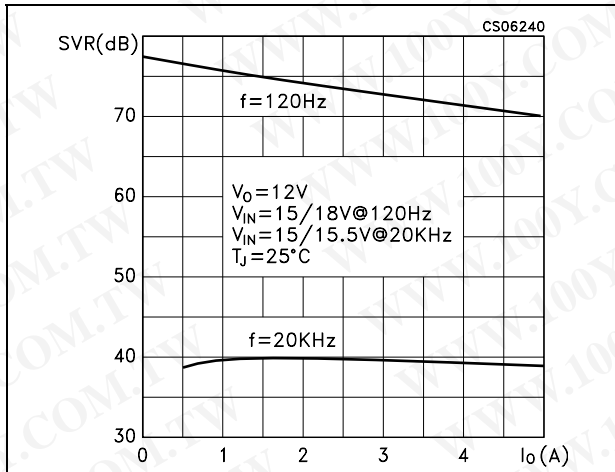

Figure 13. Dropout voltage vs temperature

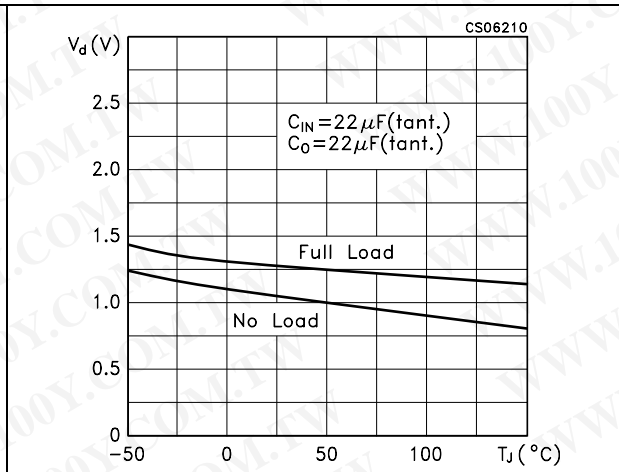

Figure 14. Supply voltage rejection vs temperature

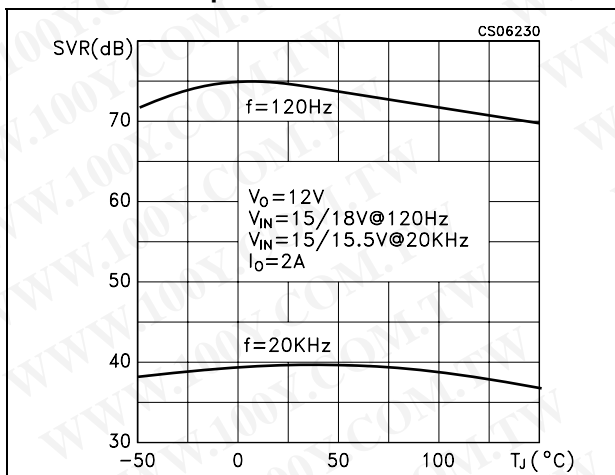

Figure 15. Supply voltage rejection vs frequency

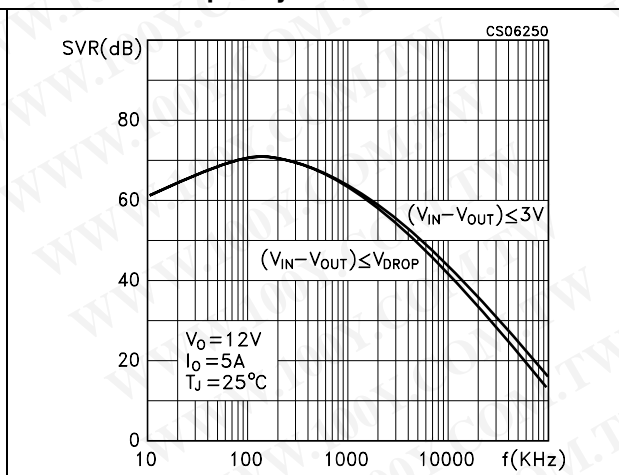

Figure 16. Adjust pin current vs output current

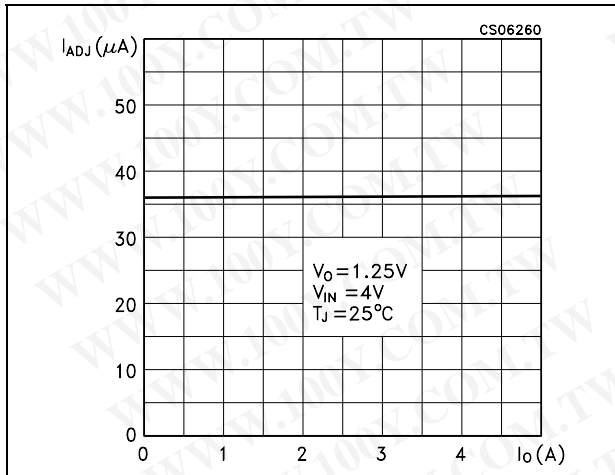

Figure 17. Reference voltage vs temperature

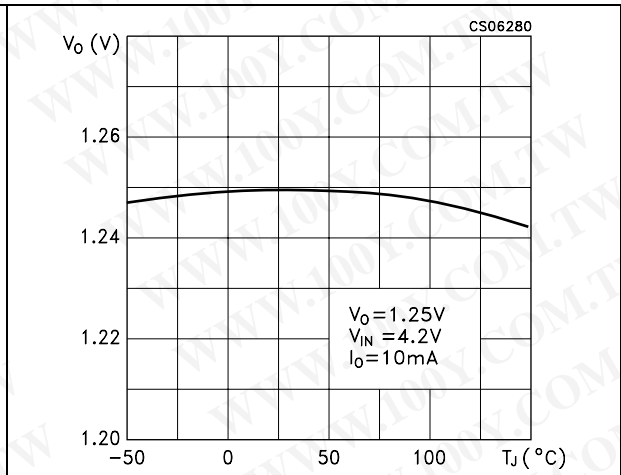

Figure 18. Load regulation vs temperature

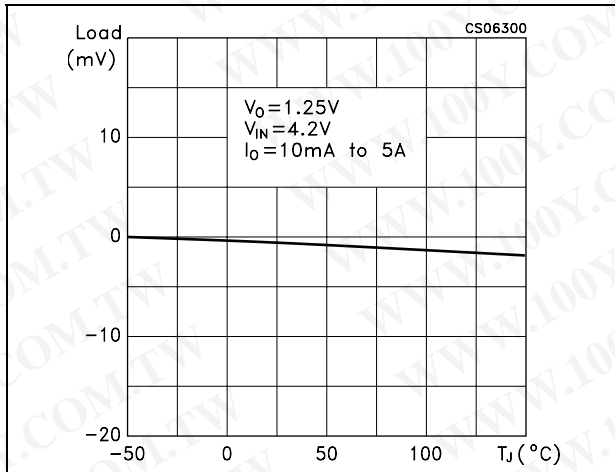

Figure 19. Adjust pin current vs temperature

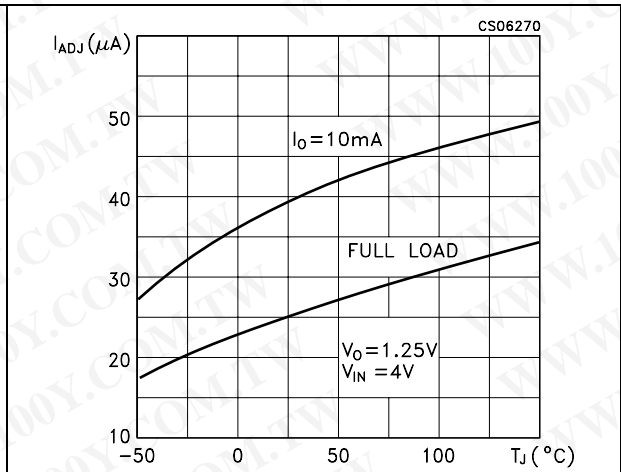

Figure 20. Line regulation vs temperature

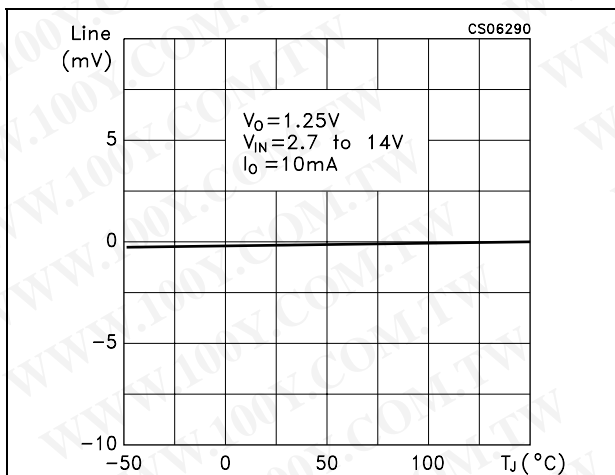

Figure 21. Minimum load current vs temperature

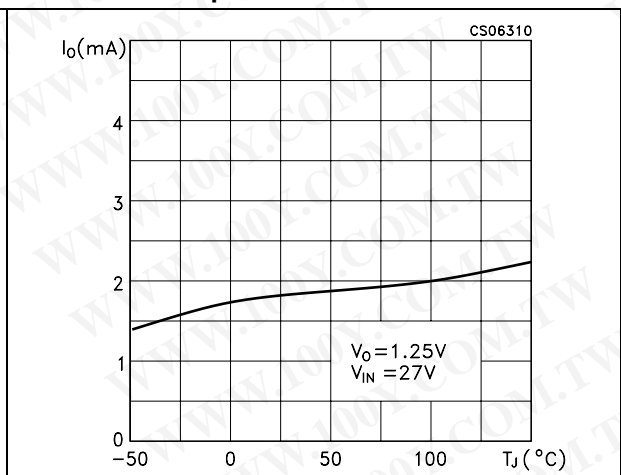

Figure 22. Supply voltage rejection vs temperature

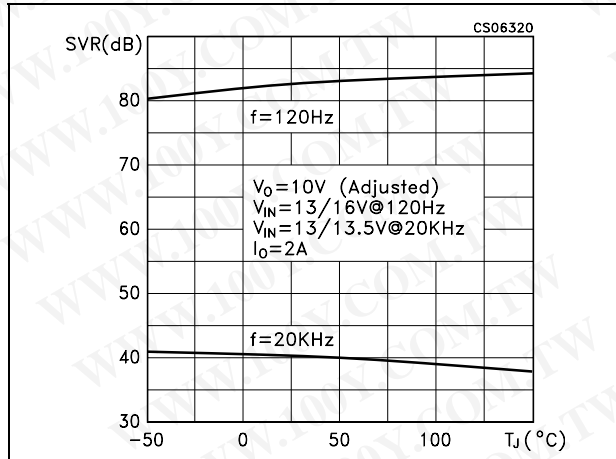

Figure 23. Supply voltage rejection vs frequency

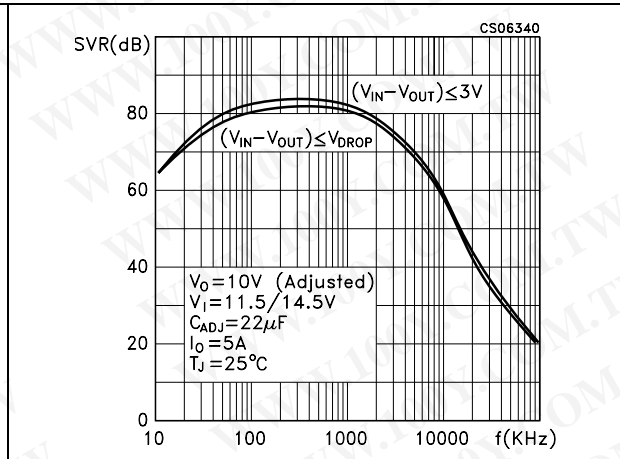

Figure 24. Stability

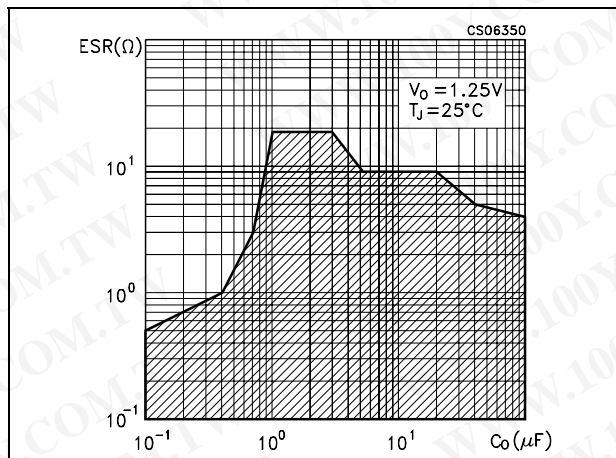

Figure 25. Supply voltage rejection vs output current

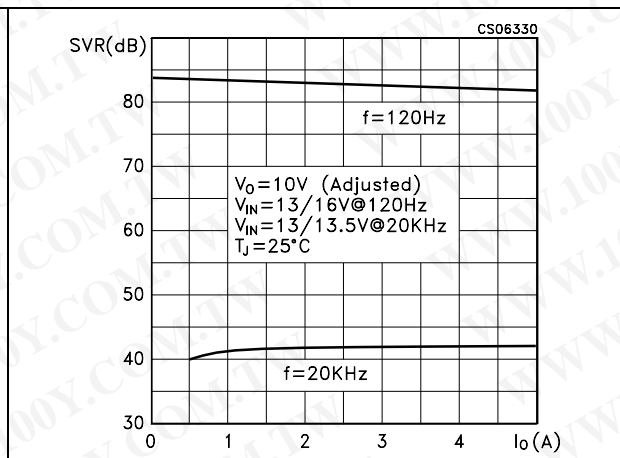

Figure 26. Stability

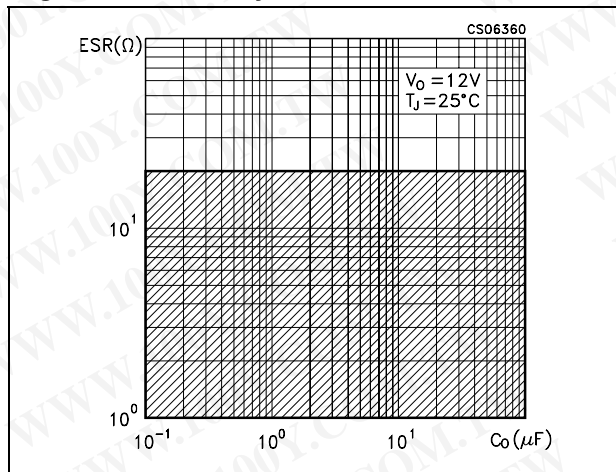

Figure 27. Line transient

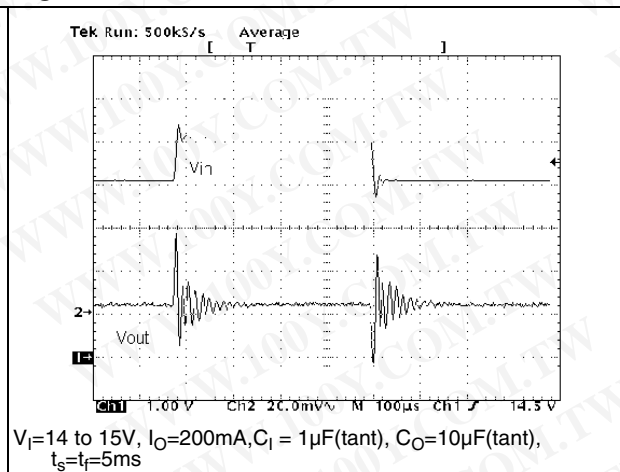

Figure 28. Line transient

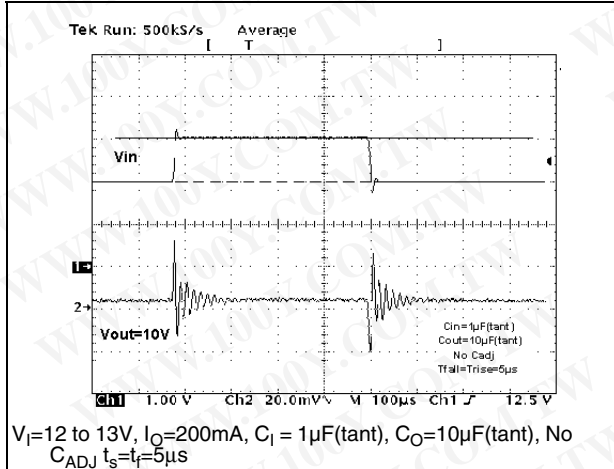

Figure 29. Load transient

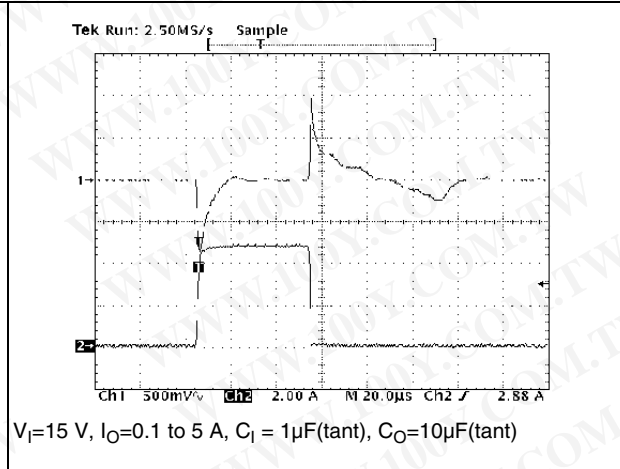

Figure 30. Load transient

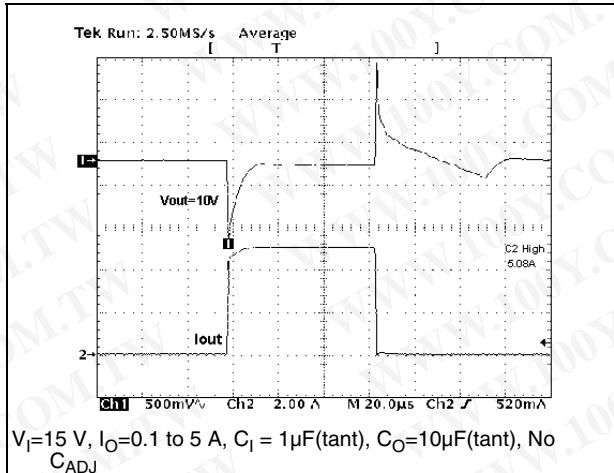

Figure 31. Line transient

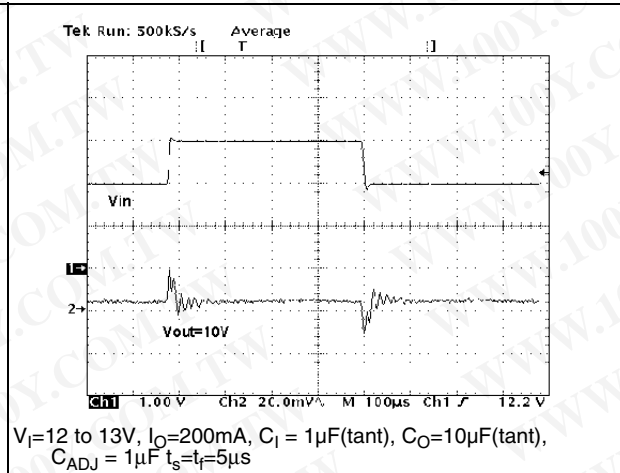
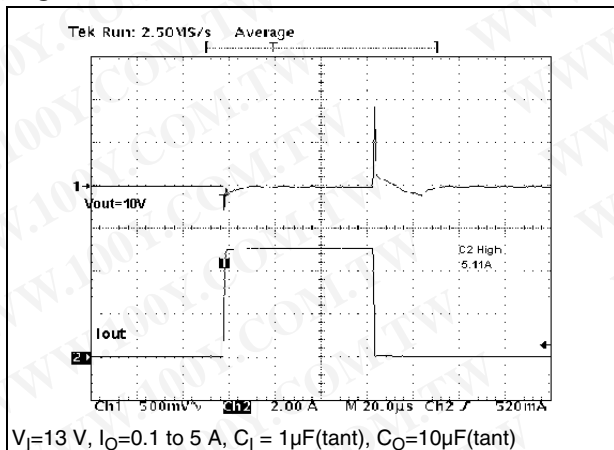

Figure 32. Load Transient



勝特力材料 886-3-5753170
 勝特力电子(上海) 86-21-54151736
 勝特力电子(深圳) 86-755-83298787
[Http://www.100y.com.tw](http://www.100y.com.tw)

7 Package mechanical data

In order to meet environmental requirements, ST offers these devices in ECOPACK® packages. These packages have a lead-free second level interconnect. The category of second Level Interconnect is marked on the package and on the inner box label, in compliance with JEDEC Standard JESD97. The maximum ratings related to soldering conditions are also marked on the inner box label. ECOPACK is an ST trademark. ECOPACK specifications are available at: www.st.com.

TO-220 mechanical data

Dim.	mm.			inch.		
	Min.	Typ.	Max.	Min.	Typ.	Max.
A	4.40		4.60	0.173		0.181
C	1.23		1.32	0.048		0.051
D	2.40		2.72	0.094		0.107
D1		1.27			0.050	
E	0.49		0.70	0.019		0.027
F	0.61		0.88	0.024		0.034
F1	1.14		1.70	0.044		0.067
F2	1.14		1.70	0.044		0.067
G	4.95		5.15	0.194		0.203
G1	2.4		2.7	0.094		0.106
H2	10.0		10.40	0.393		0.409
L2		16.4			0.645	
L4	13.0		14.0	0.511		0.551
L5	2.65		2.95	0.104		0.116
L6	15.25		15.75	0.600		0.620
L7	6.2		6.6	0.244		0.260
L9	3.5		3.93	0.137		0.154
DIA.	3.75		3.85	0.147		0.151

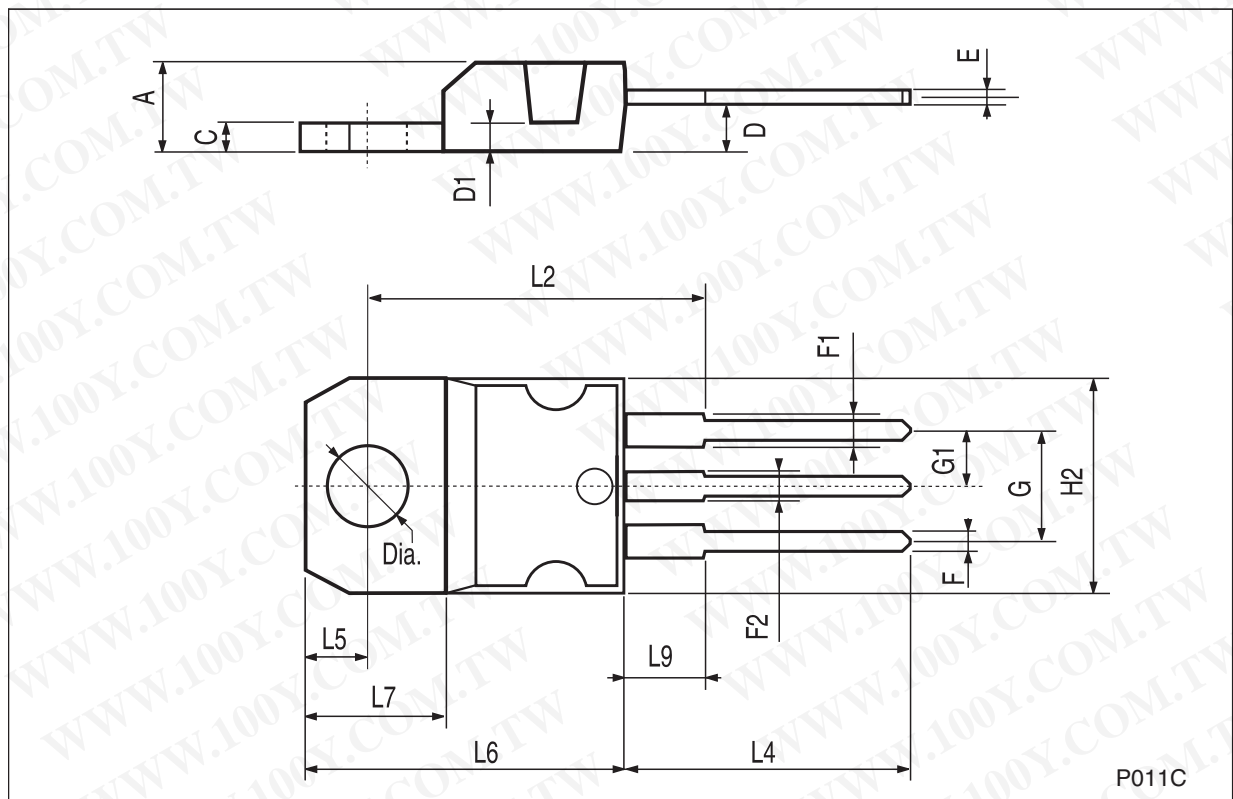

8 Revision history

Table 8. Document revision history

Date	Revision	Changes
07-Oct-2004	3	Mistake order codes - Table 1.
08-Feb-2005	4	Mistake U.M. Load Regulation - V ==> mV.
16-Jun-2005	5	Order codes updated.
04-Apr-2007	6	Order code updated.
07-Jun-2007	7	Order codes updated.
08-Apr-2008	8	Modified: Table 1 on page 1 . Removed: packages D ² PAK, D ² PAK/A and mechanical data.

勝特力材料 886-3-5753170
勝特力电子(上海) 86-21-54151736
勝特力电子(深圳) 86-755-83298787
[Http://www.100y.com.tw](http://www.100y.com.tw)

勝特力材料 886-3-5753170
勝特力电子(上海) 86-21-54151736
勝特力电子(深圳) 86-755-83298787
[Http://www.100y.com.tw](http://www.100y.com.tw)

Please Read Carefully:

Information in this document is provided solely in connection with ST products. STMicroelectronics NV and its subsidiaries ("ST") reserve the right to make changes, corrections, modifications or improvements, to this document, and the products and services described herein at any time, without notice.

All ST products are sold pursuant to ST's terms and conditions of sale.

Purchasers are solely responsible for the choice, selection and use of the ST products and services described herein, and ST assumes no liability whatsoever relating to the choice, selection or use of the ST products and services described herein.

No license, express or implied, by estoppel or otherwise, to any intellectual property rights is granted under this document. If any part of this document refers to any third party products or services it shall not be deemed a license grant by ST for the use of such third party products or services, or any intellectual property contained therein or considered as a warranty covering the use in any manner whatsoever of such third party products or services or any intellectual property contained therein.

UNLESS OTHERWISE SET FORTH IN ST'S TERMS AND CONDITIONS OF SALE ST DISCLAIMS ANY EXPRESS OR IMPLIED WARRANTY WITH RESPECT TO THE USE AND/OR SALE OF ST PRODUCTS INCLUDING WITHOUT LIMITATION IMPLIED WARRANTIES OF MERCHANTABILITY, FITNESS FOR A PARTICULAR PURPOSE (AND THEIR EQUIVALENTS UNDER THE LAWS OF ANY JURISDICTION), OR INFRINGEMENT OF ANY PATENT, COPYRIGHT OR OTHER INTELLECTUAL PROPERTY RIGHT.

UNLESS EXPRESSLY APPROVED IN WRITING BY AN AUTHORIZED ST REPRESENTATIVE, ST PRODUCTS ARE NOT RECOMMENDED, AUTHORIZED OR WARRANTED FOR USE IN MILITARY, AIR CRAFT, SPACE, LIFE SAVING, OR LIFE SUSTAINING APPLICATIONS, NOR IN PRODUCTS OR SYSTEMS WHERE FAILURE OR MALFUNCTION MAY RESULT IN PERSONAL INJURY, DEATH, OR SEVERE PROPERTY OR ENVIRONMENTAL DAMAGE. ST PRODUCTS WHICH ARE NOT SPECIFIED AS "AUTOMOTIVE GRADE" MAY ONLY BE USED IN AUTOMOTIVE APPLICATIONS AT USER'S OWN RISK.

Resale of ST products with provisions different from the statements and/or technical features set forth in this document shall immediately void any warranty granted by ST for the ST product or service described herein and shall not create or extend in any manner whatsoever, any liability of ST.

ST and the ST logo are trademarks or registered trademarks of ST in various countries.

Information in this document supersedes and replaces all information previously supplied.

The ST logo is a registered trademark of STMicroelectronics. All other names are the property of their respective owners.

© 2008 STMicroelectronics - All rights reserved

STMicroelectronics group of companies

Australia - Belgium - Brazil - Canada - China - Czech Republic - Finland - France - Germany - Hong Kong - India - Israel - Italy - Japan - Malaysia - Malta - Morocco - Singapore - Spain - Sweden - Switzerland - United Kingdom - United States of America

www.st.com