

PQxxDZ51J00H Series/PQxxDZ11J00H Series PQ3DZ53J000H/PQ3DZ13J000H

0.5A/1.0A Output, Surface Mount type
Low Power-Loss Voltage Regulators

■ Features

1. Low power-loss
(Dropout voltage: MAX.0.5V)
2. Surface mount package (equivalent to SC-63)
3. Output voltage precision: ±3.0%
4. Built-in ON/OFF control function
5. Low dissipation current at OFF-state (I_{qs}: MAX.5μA)
6. Built-in overcurrent protection, overheat protection function, ASO protection function
7. RoHS directive compliant

■ Applications

1. Personal computers
2. CD-ROM drivers
3. Power supplies for various OA equipment

■ Model Line-up

Output current (I _o)	Package type	Output voltage (V _o)		
		3.3V	5.0V	9.0V
0.5A	Taping	PQ3DZ53J00H	PQ05DZ5J00H	PQ09DZ5J00H
	Sleeve	PQ3DZ53J000H	PQ05DZ51J00H	PQ09DZ51J00H
1A	Taping	PQ3DZ13J00H	PQ05DZ1J00H	PQ09DZ1J00H
	Sleeve	PQ3DZ13J000H	PQ05DZ11J00H	PQ09DZ11J00H
		12.0V		
0.5A	Taping	PQ12DZ5J00H		
	Sleeve	PQ12DZ51J00H		
1A	Taping	PQ12DZ1J00H		
	Sleeve	PQ12DZ11J00H		

■ Outline Dimensions

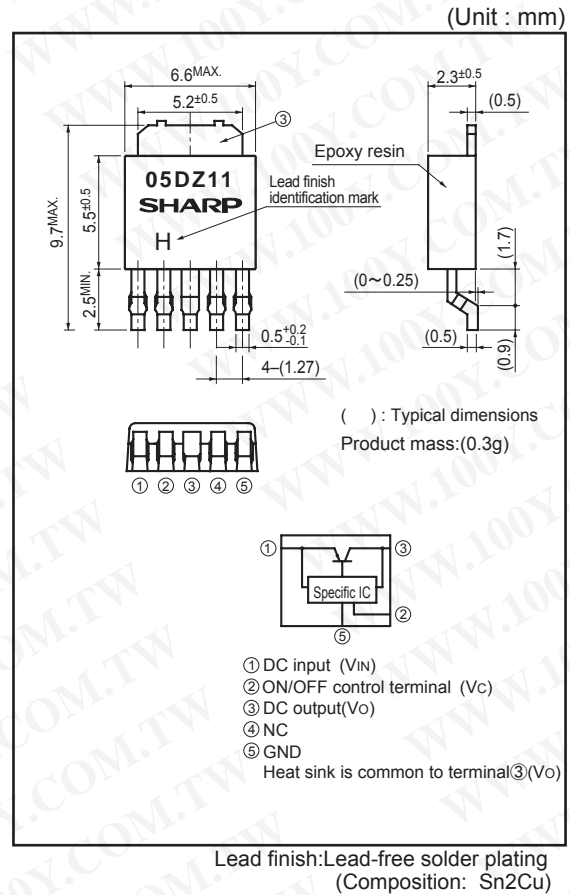

■ Absolute Maximum Ratings (T_a=25°C)

Parameter	Symbol	Rating	Unit
*1 Input voltage	V _{IN}	24	V
*1 ON/OFF control terminal voltage	V _c	24	V
Output current	I _o	0.5	A
		1.0	
*2 Power dissipation	P _D	8	W
*3 Junction temperature	T _J	150	°C
Operating temperature	T _{opr}	-20~+80	°C
Storage temperature	T _{stg}	-40~+150	°C
Soldering temperature	T _{sol}	260(10s)	°C

*1 All are open except GND and applicable terminals.

*2 P_D: With infinite heat sink

*3 There is case that overheat protection function operates at the T_J:125°C to 150°C, this item cannot be used in this temperature range.

勝特力材料 886-3-5753170
勝特力电子(上海) 86-21-34970699
勝特力电子(深圳) 86-755-83298787
[Http://www.100y.com.tw](http://www.100y.com.tw)

Notice The content of data sheet is subject to change without prior notice.

In the absence of confirmation by device specification sheets, SHARP takes no responsibility for any defects that may occur in equipment using any SHARP devices shown in catalogs, data books, etc. Contact SHARP in order to obtain the latest device specification sheets before using any SHARP device.

Electrical Characteristics

(Unless otherwise specified, condition shall be $V_c=2.7V, I_o=0.3A$ [PQxxDZ51J00H series/PQ3DZ53J000H], $I_o=0.5A$ [PQxxDZ11J00H series/PQ3DZ13J000H], $T_a=25^\circ C$)

Parameter	Symbol	Conditions	MIN.	TYP.	MAX.	Unit	
Output voltage	V_o	*4	PQ3DZ53J000H/PQ3DZ13J000H	3.201	3.3	3.399	V
			PQ05DZ51J00H/PQ05DZ11J00H	4.85	5.0	5.15	
			PQ09DZ51J00H/PQ09DZ11J00H	8.73	9.0	9.27	
			PQ12DZ51J00H/PQ12DZ11J00H	11.64	12.0	12.36	
Load regulation	Reg_L	PQxxDZ51J00H series	$I_o=5mA$ to $0.5A$ *4	—	*8 0.2	2.0	%
		PQxxDZ11J00H series	$I_o=5mA$ to $1.0A$ *4	—	—	—	
Line regulation	Reg_I	*5, $I_o=5mA$	—	*8 0.1	2.5	%	
Temperature coefficient of output voltage	TcV_o	$T_j=0$ to $125^\circ C, I_o=5mA, *$ 4	—	*9 ± 0.01	—	%/ $^\circ C$	
Ripple Rejection	RR	Refer to Fig.2	45	60	—	dB	
Dropout voltage	V_{I-O}	*6, $I_o=0.3A$	—	*8 0.2	0.5	V	
		*6, $I_o=0.5A$	—	—	—		
*7 ON-state voltage for control	$V_{C(ON)}$	*4	2.0	—	—	V	
ON-state current for control	$I_{C(ON)}$	*4	—	—	200	μA	
OFF-state voltage for control	$V_{C(OFF)}$	$I_o=0A, *$ 4	—	—	0.8	V	
OFF-state current for control	$I_{C(OFF)}$	$V_c=0.4V, I_o=0A, *$ 4	—	—	2	μA	
Quiescent current	I_q	$I_o=0A, *$ 4	—	*8 4	10	mA	
Output OFF-state dissipation current	I_{qs}	$V_c=0.4V, I_o=0A, *$ 4	—	—	5	μA	

*4 PQ3DZ53J000H/PQ3DZ13J000H: $V_{IN}=5V, PQ05DZ51J00H/11J00H: V_{IN}=7V, PQ09DZ51J00H/11J00H: V_{IN}=11V, PQ12DZ51J00H/11J00H: V_{IN}=14V$

*5 PQ3DZ53J000H/13J000H: $V_{IN}=4$ to $10V, PQ05DZ51J00H/11J00H: V_{IN}=6$ to $16V, PQ09DZ51J00H/11J00H: V_{IN}=10$ to $20V, PQ12DZ51J00H/11J00H: V_{IN}=13$ to $23V$

*6 Input voltage shall be the value when output voltage is 95% in comparison with the initial value. PQ3DZ53J000H/13J000H: $V_{IN}=3.7V$

*7 In case of opening control terminal ②, output voltage turns off.

*8 Applied only to PQ05DZ51J00H/11J00H.

*9 PQ3DZ53J000H/PQ3DZ13J000H: ± 0.02

Fig.1 Test Circuit

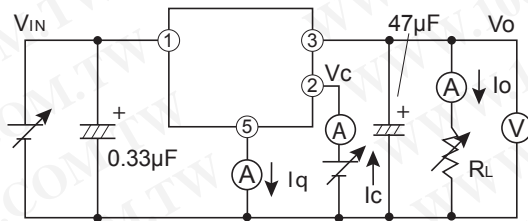

勝特力材料 886-3-5753170
勝特力电子(上海) 86-21-34970699
勝特力电子(深圳) 86-755-83298787
[Http://www.100y.com.tw](http://www.100y.com.tw)

Fig.2 Test Circuit for Ripple Rejection

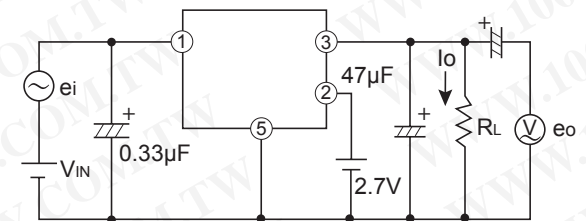

$f=120Hz$ (sine wave)
 $e_i(rms)=0.5V$
 $V_{IN}=5V$ (PQ3DZ53J000H/13J000H)
7V(PQ05DZ51J00H/11J00H)
11V(PQ09DZ51J00H/11J00H)
14V(PQ12DZ51J00H/11J00H)
 $I_o=0.3A$
 $RR=20 \log(e_i(rms)/e_o(rms))$

Fig.3 Power Dissipation vs. Ambient Temperature

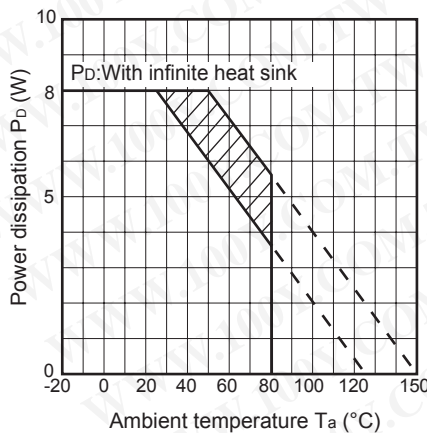

Note) Oblique line portion: Overheat protection may operate in this area.

Fig.4 Overcurrent Protection Characteristics (Typical Value) (PQ3DZ53J000H)

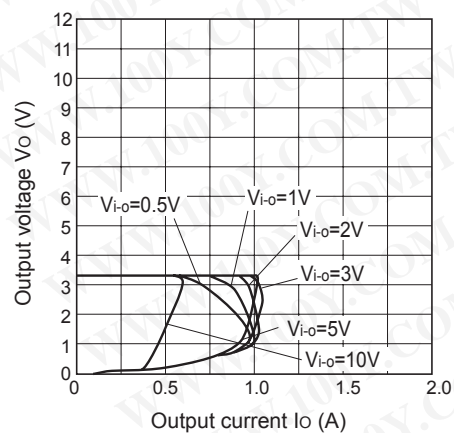

Fig.5 Overcurrent Protection Characteristics (Typical Value) (PQ3DZ13J000H)

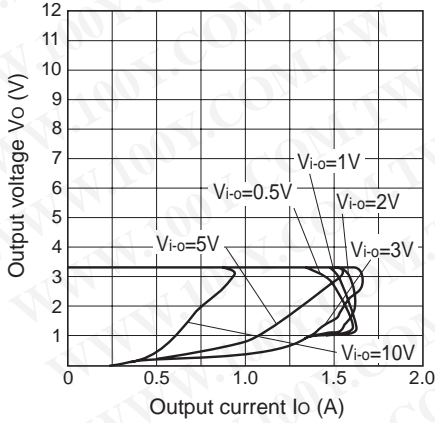

Fig.6 Overcurrent Protection Characteristics (Typical Value) (PQ05DZ51J00H)

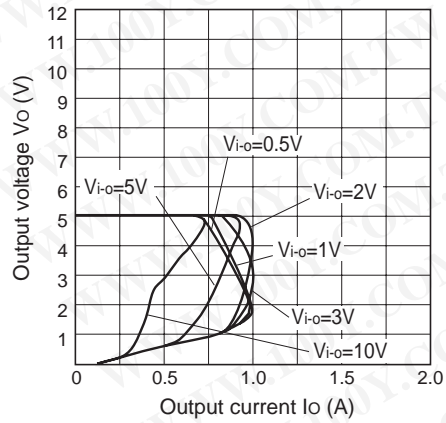

Fig.7 Overcurrent Protection Characteristics (Typical Value) (PQ09DZ51J00H)

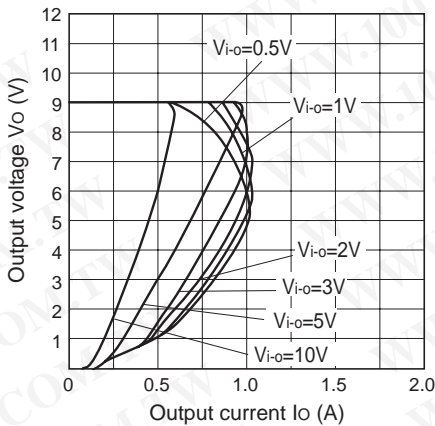

Fig.8 Overcurrent Protection Characteristics (Typical Value) (PQ12DZ51J00H)

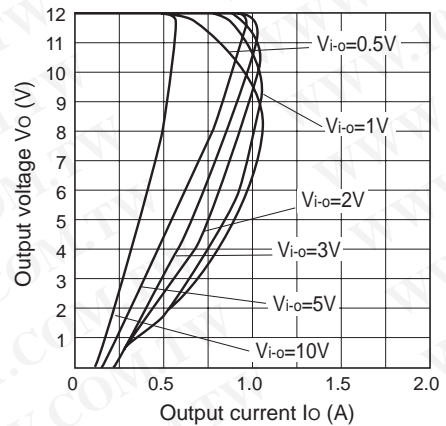

Fig.9 Overcurrent Protection Characteristics (Typical Value) (PQ05DZ11J00H)

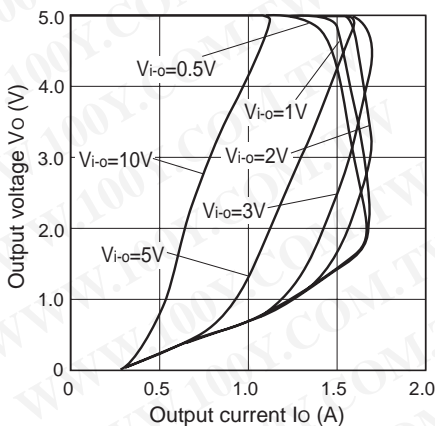

Fig.10 Overcurrent Protection Characteristics (Typical Value) (PQ09DZ11J00H)

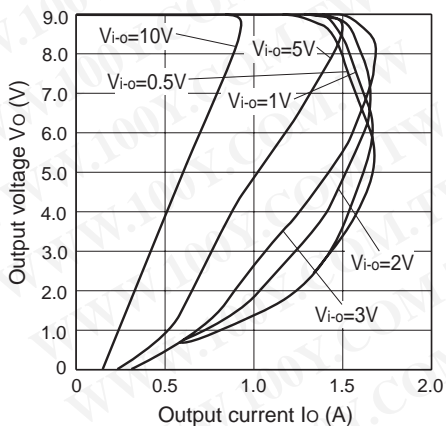
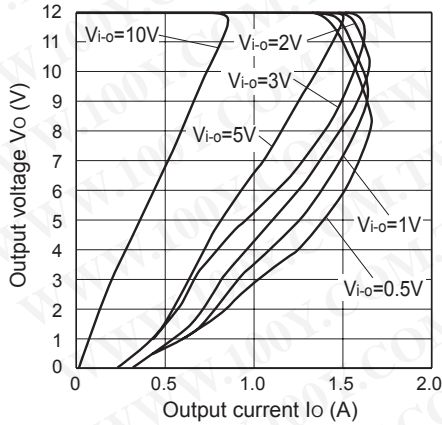
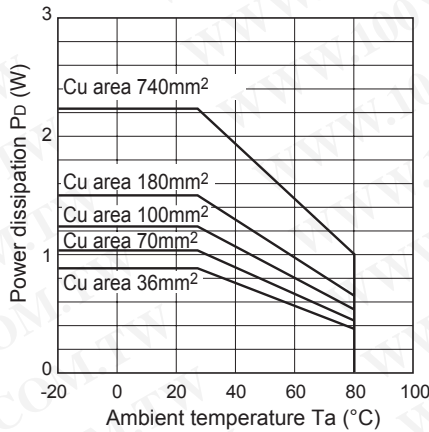

Fig.11 Overcurrent Protection Characteristics (Typical Value) (PQ12DZ11J00H)



勝特力材料 886-3-5753170
 勝特力电子(上海) 86-21-34970699
 勝特力电子(深圳) 86-755-83298787
[Http://www.100y.com.tw](http://www.100y.com.tw)

Fig.12 Power Dissipation vs. Ambient Temperature (Typical Value)



Mounting PCB

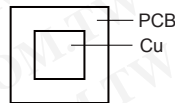

Material : Glass-cloth epoxy resin
 Size : 50×50×1.6mm
 Cu thickness : 35μm

Fig.13 Output Voltage Deviation vs. Junction Temperature (PQ3DZ53J000H/PQ3DZ13J000H)

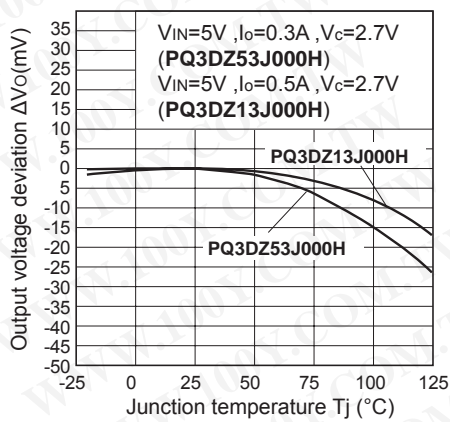

Fig.14 Output Voltage Deviation vs. Junction Temperature (PQ05DZ51J00H/PQ05DZ11J00H)

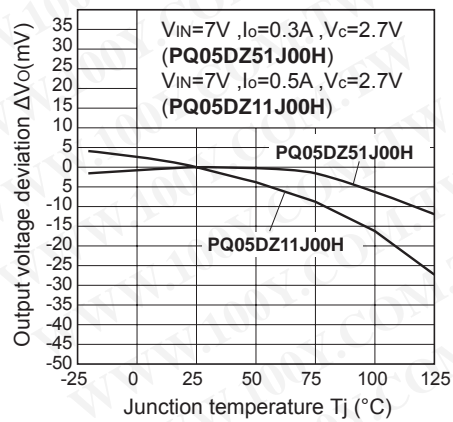

Fig.15 Output Voltage Deviation vs. Junction Temperature (PQ09DZ51J00H/PQ09DZ11J00H)

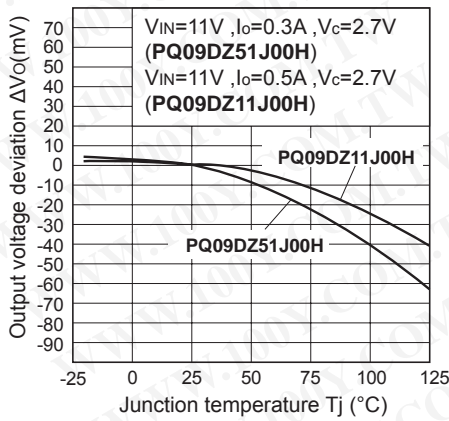

Fig.16 Output Voltage Deviation vs. Junction Temperature (PQ12DZ51J00H/PQ12DZ11J00H)

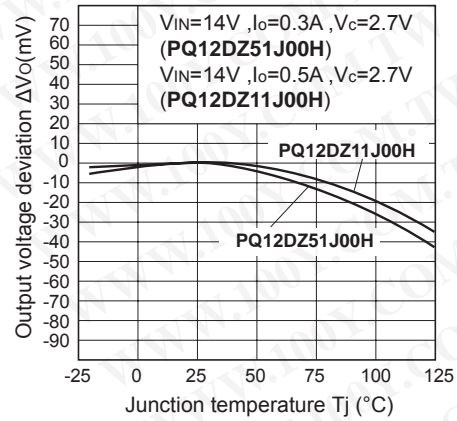

Fig.17 Output Voltage vs. Input Voltage (Typical Value) (PQ3DZ53J000H)

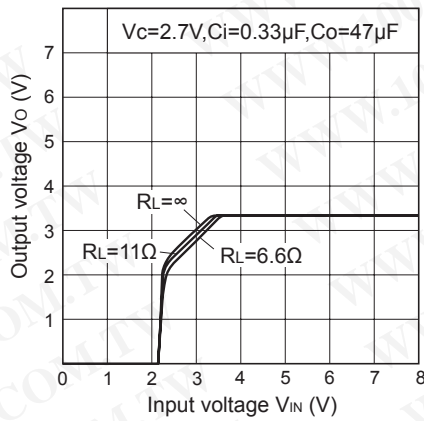

Fig.18 Output Voltage vs. Input Voltage (Typical Value) (PQ05DZ51J00H)

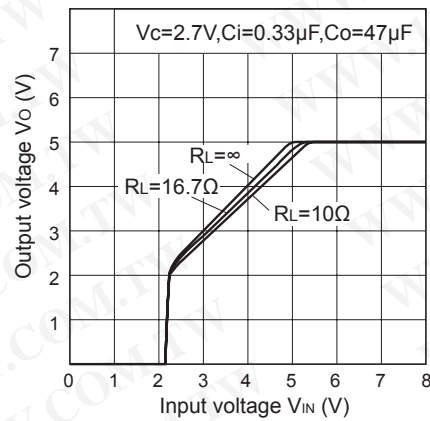

Fig.19 Output Voltage vs. Input Voltage (Typical Value) (PQ09DZ51J00H)

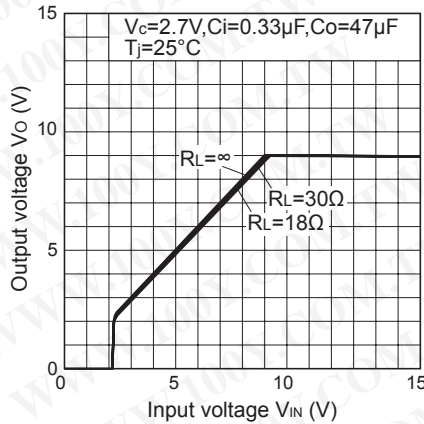
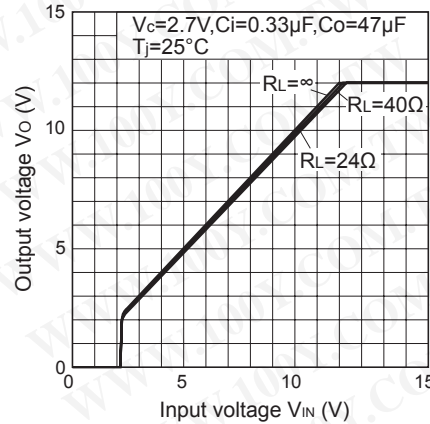

Fig.20 Output Voltage vs. Input Voltage (Typical Value) (PQ12DZ51J00H)



勝特力材料 886-3-5753170
 勝特力电子(上海) 86-21-34970699
 勝特力电子(深圳) 86-755-83298787
[Http://www.100y.com.tw](http://www.100y.com.tw)

Fig.21 Output Voltage vs. Input Voltage (Typical Value) (PQ3DZ13J000H)

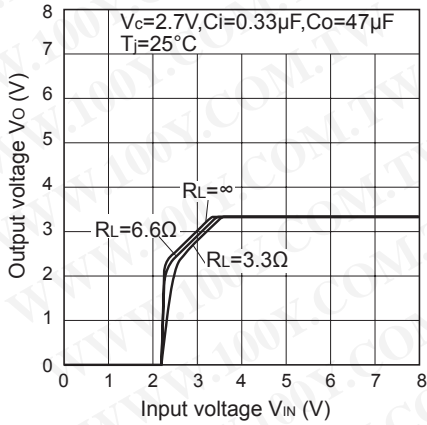

Fig.22 Output Voltage vs. Input Voltage (Typical Value) (PQ05DZ11J00H)

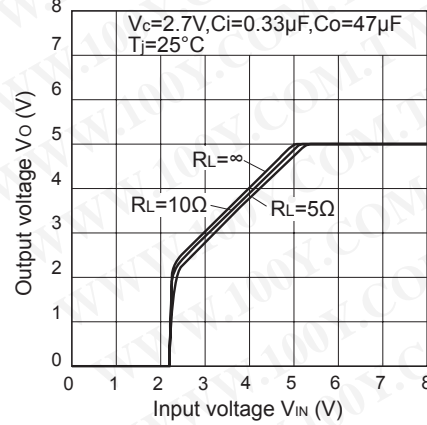

Fig.23 Output Voltage vs. Input Voltage (Typical Value) (PQ09DZ11J00H)

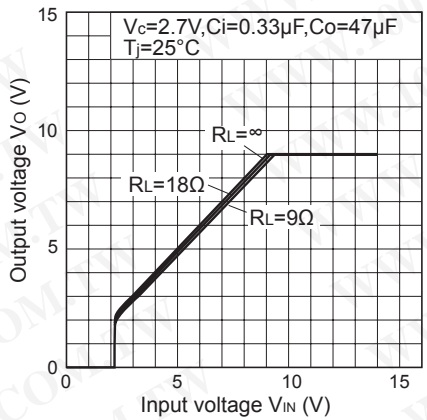

Fig.24 Output Voltage vs. Input Voltage (Typical Value) (PQ12DZ11J00H)

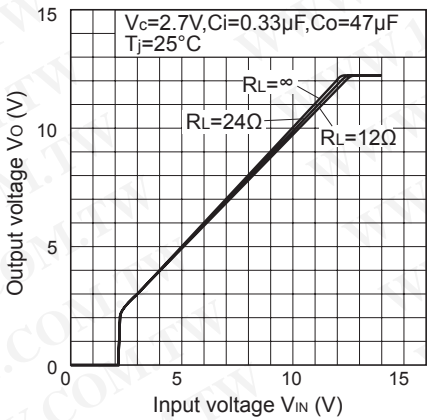

Fig.25 Circuit Operating Current vs. Input Voltage (PQ3D53J000H)

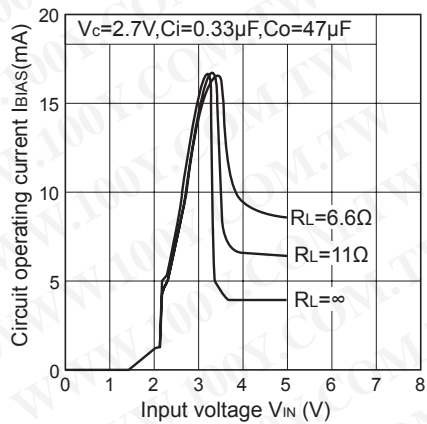
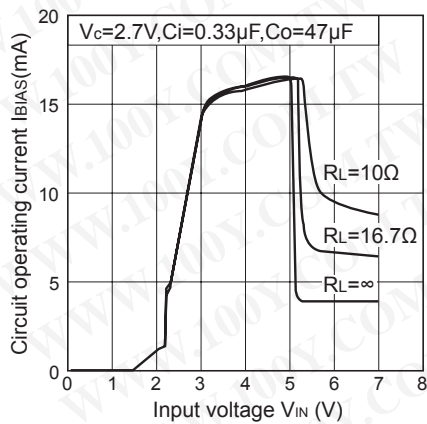

Fig.26 Circuit Operating Current vs. Input Voltage (PQ05D51J00H)



勝特力材料 886-3-5753170
 勝特力电子(上海) 86-21-34970699
 勝特力电子(深圳) 86-755-83298787
[Http://www.100y.com.tw](http://www.100y.com.tw)

Fig.27 Circuit Operating Current vs. Input Voltage(PQ09DZ51J00H)

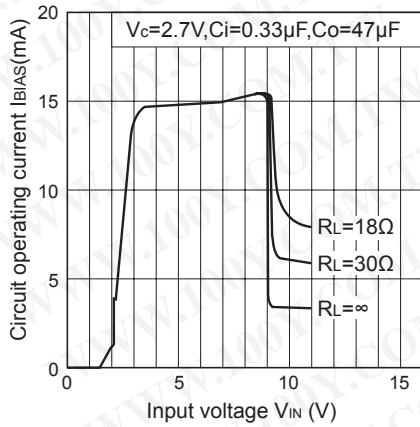

Fig.28 Circuit Operating Current vs. Input Voltage(PQ12DZ51J00H)

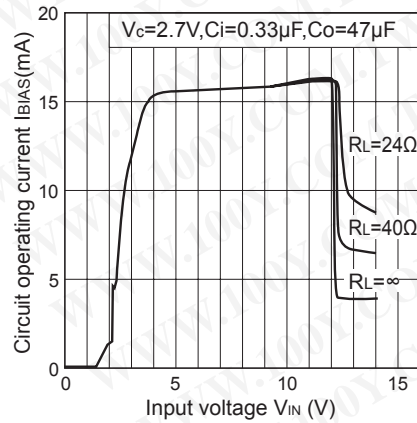

Fig.29 Circuit Operating Current vs. Input Voltage(PQ3DZ13J000H)

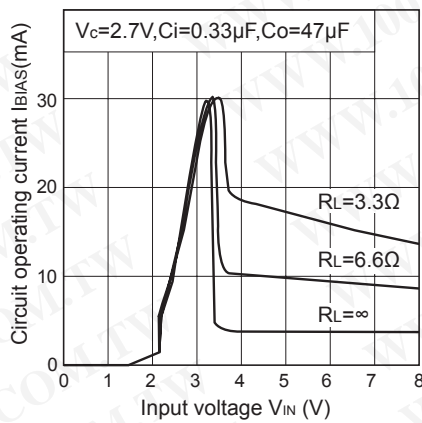

Fig.30 Circuit Operating Current vs. Input Voltage(PQ05DZ11J00H)

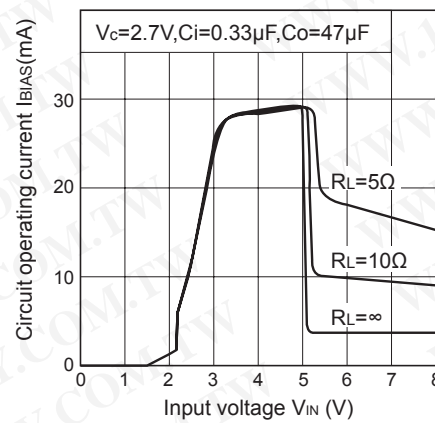

Fig.31 Circuit Operating Current vs. Input Voltage(PQ09DZ11J00H)

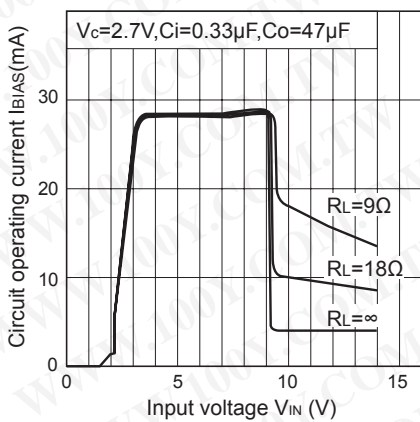
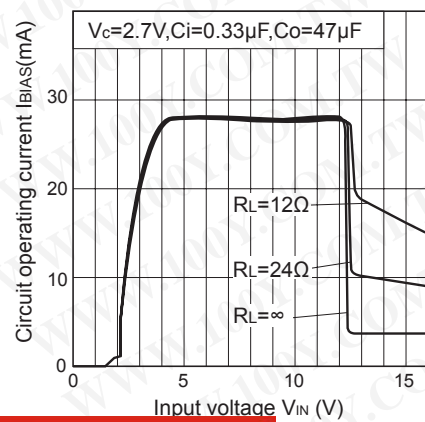

Fig.32 Circuit Operating Current vs. Input Voltage(PQ12DZ11J00H)



勝特力材料 886-3-5753170
勝特力电子(上海) 86-21-34970699
勝特力电子(深圳) 86-755-83298787
[Http://www.100y.com.tw](http://www.100y.com.tw)

Fig.33 Dropout Voltage vs. Junction Temperature (PQxxDZ51J00H series/PD3DZ53J000H)

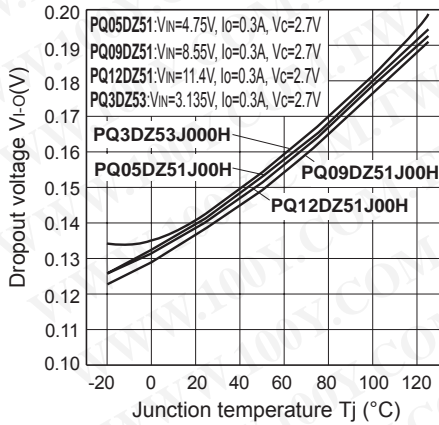

Fig.34 Dropout Voltage vs. Junction Temperature (PQxxDZ11J00H series/PD3DZ13J000H)

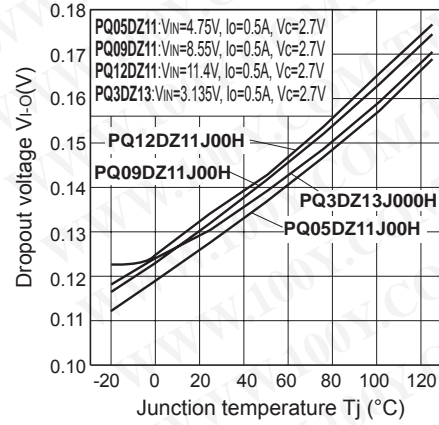

Fig.35 Quiescent Current vs. Junction Temperature (PQxxDZ51J00H series/PQ3DZ53J000H)

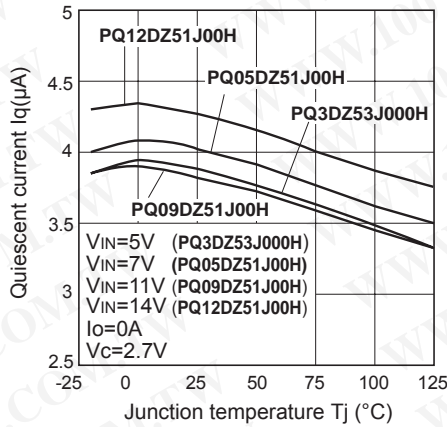

Fig.36 Quiescent Current vs. Junction Temperature (PQxxDZ11J00H series/PQ3DZ13J000H)

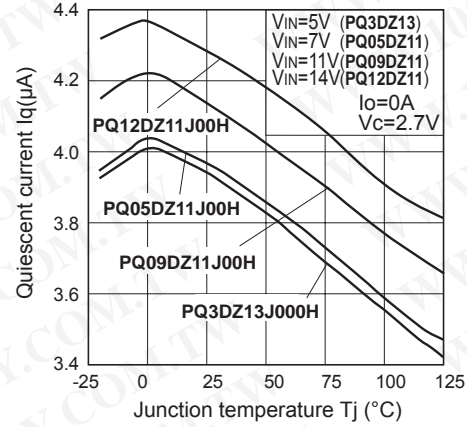

Fig.37 Ripple Rejection vs. Input Ripple Frequency (PQxxDZ51J00H series/PQ3DZ53J000H)

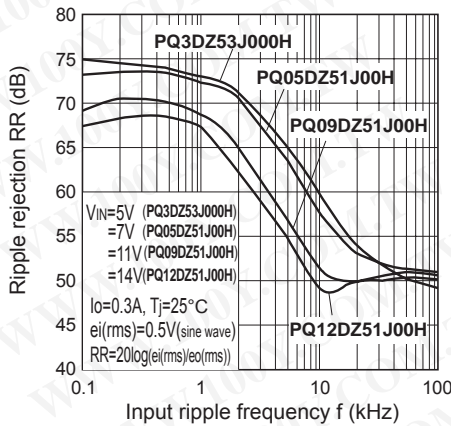

Fig.38 Ripple Rejection vs. Input Ripple Frequency (PQxxDZ11J00H series/PQ3DZ13J000H)

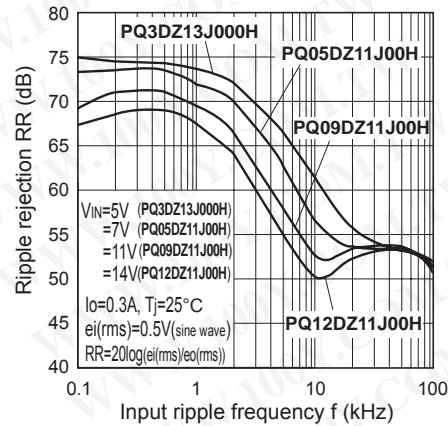

Fig.39 Ripple Rejection vs. Output Current
(PQxxDZ51J00H series/PQ3DZ53J000H)

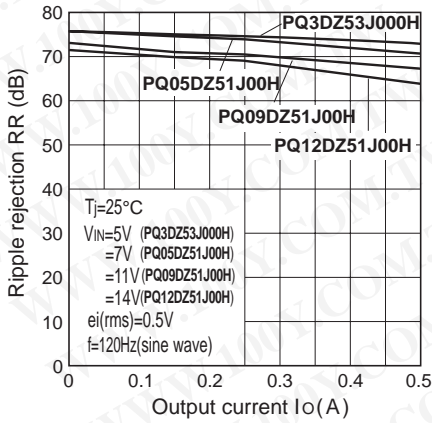
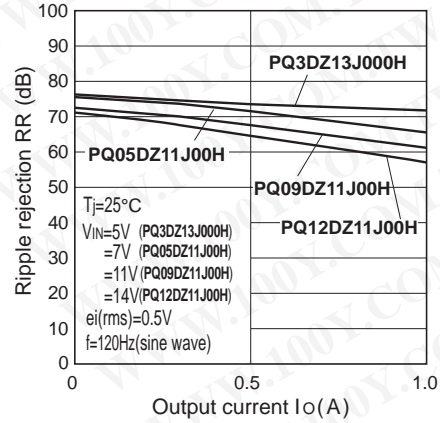
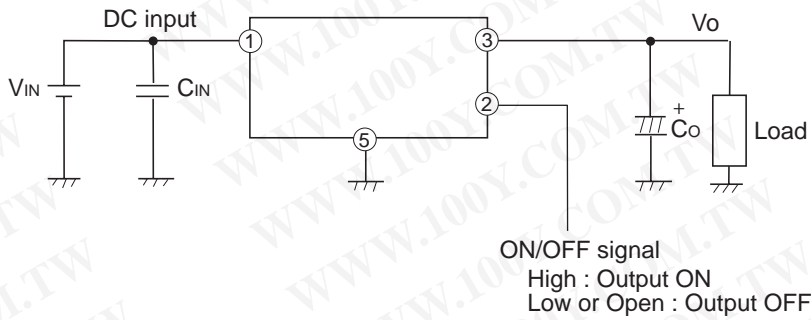

Fig.40 Ripple Rejection vs. Output Current
(PQxxDZ11J00H series/PQ3DZ13J000H)



Typical Application



勝特力材料 886-3-5753170
 勝特力电子(上海) 86-21-34970699
 勝特力电子(深圳) 86-755-83298787
[Http://www.100y.com.tw](http://www.100y.com.tw)